



**HAL**  
open science

## Decision support for R&D activities of innovative technologies

Alborz Bekhradi, Bernard Yannou, François Cluzel, Michael Kokkolaras

► **To cite this version:**

Alborz Bekhradi, Bernard Yannou, François Cluzel, Michael Kokkolaras. Decision support for R&D activities of innovative technologies. IDETC/CIE 2018: International Design Engineering Technical Conferences / CIE: Computers and Information in Engineering, ASME, Aug 2018, Québec, Canada. pp.V02AT03A046. hal-01786713

**HAL Id: hal-01786713**

**<https://hal.science/hal-01786713v1>**

Submitted on 1 Feb 2019

**HAL** is a multi-disciplinary open access archive for the deposit and dissemination of scientific research documents, whether they are published or not. The documents may come from teaching and research institutions in France or abroad, or from public or private research centers.

L'archive ouverte pluridisciplinaire **HAL**, est destinée au dépôt et à la diffusion de documents scientifiques de niveau recherche, publiés ou non, émanant des établissements d'enseignement et de recherche français ou étrangers, des laboratoires publics ou privés.

# DECISION SUPPORT FOR R&D ACTIVITIES OF INNOVATIVE TECHNOLOGIES

**Alexandre Bekhradi**

Laboratoire Genie Industriel, CentraleSupélec  
Universite Paris-Saclay  
Gif-sur-Yvette, France

**François Cluzel**

Laboratoire Genie Industriel, CentraleSupélec  
Universite Paris-Saclay  
Gif-sur-Yvette, France

**Bernard Yannou**

Laboratoire Genie Industriel, CentraleSupélec  
Universite Paris-Saclay  
Gif-sur-Yvette, France

**Michael Kokkolaras**

Department of Mechanical Engineering  
McGill University  
Montréal, Canada

## ABSTRACT

Experimentation and validation tests conducted by or for technology startups are often costly, time-consuming, and, above all, not well organized. A review of the literature shows that existing tools and methods are either oriented towards lean iterative tests or strongly focused on technology improvement. There is therefore a gap to bridge by providing tangible decision-making supports involving both market and technology aspects. This paper introduces a new quantitative methodology called RITHM (Roadmapping Investments in TechNology and Marketing), which is a structured process that enables startups to systematically experiment and reach, with relatively small effort, adequate maturity level for the most promising markets. The objective of this methodology is to model and optimize tests in the front end of innovation to progressively reduce uncertainties and risks before the launch of the product. A case study of a shape shifting technology is presented in this paper to illustrate the application of RITHM.

## INTRODUCTION

The number of startup companies that have an innovative technology to launch on the market surged to 47% in the last decade, while in the US more than 73% of the startups are technology-based (Wu and Atkinson 2017). These so-called technology (or “*technology-driven*”) startups are considered as a key driver of economic growth and competitiveness in most countries.

Technology startups are highly R&D-intensive since they have a technological core to mature and commercialize (Deeds 2001). As such, they have costly and time-consuming R&D practices. These activities include iteratively experimenting prototypes with the purpose of reducing uncertainties and risks before the launch of the technology on the market.

Even though “technology” is a wide concept, one can underline that different forms of a technology can be applied to different markets of different natures. Technology is thus a multi-faceted object that can be commercialized in various markets and in its matured fashion.

Given the expansion of technology-driven startups, and the complexity of testing and developing a technology, there is a crucial need to structure their R&D processes.

The existing literature, which lies on the boundary of disciplines such as technology management, innovation management, and design engineering, provides guidelines to these companies to make more efficient tests through several methods and tools including Lean Startup (Ries 2011), test process of Value Proposition Design (Osterwalder et al. 2015), Design of Experiments (DoE) (Fisher 1937), and technology maturity evaluation by TRL (Technology Readiness Level) (Mankins 1995).

The provided guidelines of these methods and tools are either qualitative (such as minimum viable product (MVP) and loop-based build-measure-learn principles of Lean Startup) or too specific to the design of technological solutions, without necessarily considering business implications of the solution (e.g., the DoE approach). Moreover, the existing approaches are solution-focused (such as Design Thinking and its iterative process) and do not systematically explore and quantify the design problem in the front end of innovation.

A survey among innovative startups in the Paris area (75% of which are technology-driven) (Bekhradi et al. 2015) showed that despite their global awareness about the abovementioned tools and methods, their following frequently-asked questions remain without satisfactory answers: What are the most promising markets to be targeted according to the current development of the technology? And which test scenarios must be conducted to improve the technology and reach these markets, and following which roadmap?

Seeking reliable answers to these questions is the objective of our work. In this context, this paper aims at providing quantitative decision-making support to companies in terms of (i) identifying the most attractive markets to target by considering the current state of its technology and business development and (ii) identifying cost-effective test scenarios allowing the company to reach those markets. An exploratory set-based approach constitutes the backbone of a methodological framework proposed in this paper. This framework is called RITHM (for Roadmapping Investments in TechNology and Marketing) and makes a point of quantifying unsolved or

poorly-solved problems in different markets or usage situations, as a first step. Subsequently, along with investigating the core of a technology, it allows quantifying the techno-marketing gap that a startup must bridge. Finally, the technology and business experimentation scenarios are modeled, and those that enable the company to bridge the identified gap by mobilizing less R&D efforts are identified and planned.

The final results of this research work contribute to steering R&D investments of a technology startup to those markets that contain higher value-creation potential. Thanks to these results, tangible techno-marketing roadmaps are identified in the context of the studied startups. A set-based approach helps progressively reducing uncertainties by targeting a “useful problem” and consequently reducing waste of time and other resources that might have been caused if the startup merely followed an iterative solution-focused approach.

We first review the literature related to testing methods and tools for technology development. We then present the RITHM methodology as a new quantitative method to monitor the R&D of a technology through the assessment of cost-effective tests. The application of the RITHM methodology is illustrated through the case of an innovative startup developing a shape changing technology. Finally, we discuss further applications of the introduced methodology as well as its current limitations.

## TESTING APPROACHES FOR INNOVATIVE TECHNOLOGY MATURATION

Testing is the integrated sequence of the new product development (NPD) process. For the purposes of this paper, testing methods, procedures, and operational tools are reviewed in the context of engineering design, innovation, and technology management.

The stage-and-gate process (Cooper 1990) follows a series of steps including a “testing and refinement” stage before the release of the final product. This phase includes activities such as in-house (or *alpha*) testing, field (or *beta*) tests with customers, pilot or trial production, and test marketing (Cooper 2011).

Validation and verification (V&V) is applied widely in system and software engineering areas to build “faster, cheaper, and better” (Forsberg and Mooz 1999).

Regarding the experimentation activity *per se*, a design of experiments (DoE) (Fisher 1937) represents a statistical method to determine the relationships between independent variables (the presumed cause) and dependent variables (the observed effect) while holding all other potential causes constant. DoE is not used systematically in innovative entrepreneurship (Frederiksen and Brem 2017) and business experimentations. It is used mostly in lab tests to assess performance robustness of a technological system.

Other quantitative tools such as technology readiness level (TRL) (Mankins 1995) assess the maturity of

emerging technologies and evaluate the readiness of software products.

In the field of software development, more agile (or so-called lightweight) methodologies claim to overcome the limitations of traditional planning-based approaches, e.g., Extreme Programming (consisting of software quality improvement through users’ feedback loops), Crystal Methods, Scrum or Lean development (Boehm 2002, Highsmith and Cockburn 2001).

These approaches advocate a quick release of products in short development cycles proven to be transposable to technology innovative startups as proposed by Ries. Based on his personal experience in software development, Ries proposes the Lean Startup approach, which is defined as a “*set of practices for helping entrepreneurs increase their odds of building a successful startup*” (Ries 2011).

These practices encompass business-driven experimentation through the launch of a minimal viable product (MVP) to “*collect the maximum amount of validated learning [or knowledge] about customers with the least effort*”. Another founding principle of Lean Startup is the iterative product release through build-measure-learn loops, which are very similar to “Learning Cycle” (see Fig. 1) proposed by Thomke (Thomke 2003).

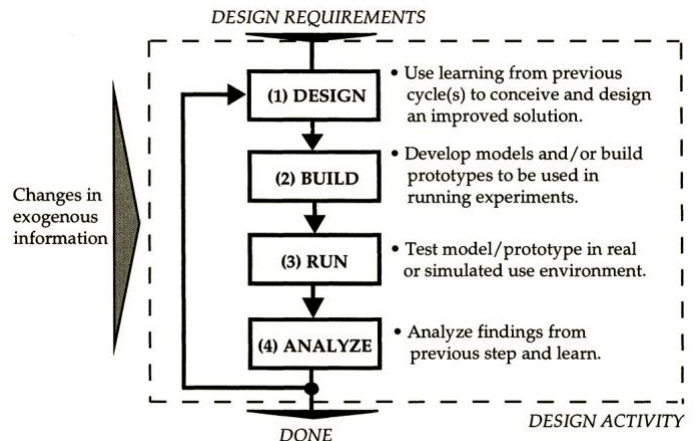

Figure 1. Iterative learning cycle (Thomke 2003)

Depending on the test and evaluation type and the maturity level of the product, the artifact to be tested may differ. The artifact to be tested is, in general, “*an approximation of the product along one or more dimensions of interest*” (Ulrich and Eppinger 2015) to verify and validate the feasibility and the proof of concept. In a business-driven experimentation, this artifact is rather an MVP or a first version of the solution to be sold to early adopters helping startups learn about customer perception.

Although these NPD approaches are well-known and deployed in the context of innovative technology startups, we believe that they have disadvantages and limitations:

- the iterations are costly and time consuming, particularly in the context of technology development;
- the process does not always enable startups to ensure the significance of the problem (or users' pains) that must be targeted by the technology;
- the technological prototype (or MVP) and its multiple facets or applications are not modeled systematically;
- the nature of tests and associated cost and time are not characterized;
- the methodological outcomes are qualitative, and their contribution to optimizing the R&D process of the company is not clear.

This paper proposes a methodological framework (called RITHM) to bridge the identified gaps in the existing methods and tools.

## THE RITHM METHODOLOGY

Roadmapping Investments in Technology and Markets (RITHM) comprises a set of structuring principles and tools aiming at making the R&D process more efficient. The objective of this methodology is to model quantitatively and optimize tests in the front end of innovation to progressively reduce uncertainties and risks before the launch of a technological solution. This is in contrast with solution-focused creativity approaches where the starting point is a *solution* idea to be prototyped and iteratively tested without necessarily measuring the importance of a *useful problem* (i.e., important pains of users occurring in frequent characteristic usage situations).

The central hypothesis of the RITHM methodology is that it may be possible to increase startup likelihood of success if its R&D process explores one or several significant and useful problem(s). In other words, a successful startup addresses users' poorly addressed or unalleviated pains instead of merely testing a solution prototype or MVP. Although the latter statement seems obvious, many startup companies begin conducting tests without fully addressing users' pains (Bekhradi et al. 2015). The lack of decision-making guidelines in the front end of innovation may be the reason for this attitude of startup companies.

RITHM has its origins in set-based thinking, which consists of reducing uncertainties from the very early design and test phases. Set-based thinking is one of the major pillars of the Lean Product Development and concurrent engineering; it is considered as the main reason of Toyota's design success in the 1990's (see, e.g., (Sobek et al. 1999)).

Compatible with the principles of set-based thinking, the Radical Innovation Design® (RID) methodology serves also as the basis of the RITHM methodology. RID is a process of systematic investigation in the front end of innovation along with a continuous uncertainty reduction that converges, before the solution and business design phases, toward a set of quantified *value buckets* (i.e.,

*"combinations of important problems/pains occurring during characteristic usage situations and for which existing solutions are generally neither useful nor efficient"* (Yannou 2015)). This falls within the scope of the *need seeker* innovation mode rather than *market reader* or *technology driver* (Jaruzelski et al. 2016) for the three identified innovation strategy categories.

In the context of RITHM, however, the mainstream innovation strategy should be a hybridization of both *technology driver* and *need seeker*, insofar as the technology startups start with a technological platform, but they do not necessarily consider the end-users and their problems. In RITHM methodology, tests are conducted once sufficient information is gathered regarding the potential markets and applications of the technology. By doing so, the concurrent engineering process is optimized given that test loopbacks are minimized thanks to the exploration in the front end of innovation. Based on this mindset, the proposed RITHM methodology seeks to propose optimal roadmaps for investing on markets with higher return on investment (ROI) as there is an important quantity of unsolved or poorly-solved problems by the existing solutions, and consequently the likelihood of coming up with blue ocean innovations (Kim and Mauborgne 2014) are higher.

### RITHM: Expected Outcomes

The expected outcomes of the proposed methodology include the quantification of *meta-value buckets* (i.e., most promising market(s) for which the technology is already mature enough or can be matured with few efforts) and the identification of investment-related decision-making guidelines on experiment(s).

In other words, RITHM enables the guidance of R&D of a technology by wisely investing on experiments that increase its maturity. These experiments are then ranked according to their efficiency and cost.

### RITHM: Nomenclature

The following nomenclature lists the main terms used in the rest of this paper:

FA	Field of Activity (technology applications)
VB	Value Bucket (frequent painful usage situations for which existing solutions are poor or not at all efficient)
Ma	Market
MAI <sub>i</sub>	Market Attractiveness Index for market <i>i</i>
TA	Technology Ability (the main functionalities of the technology enabling it to perform a given action in expected usage situations)
DSM	Dependency Structure Modeling
m-VB	meta-Value Bucket (combinations of Ma and TA where little effort is required to reach the required performance on the attractive markets)
C	Financial cost of test scenarios (in euros)
T	Time needed to conduct a test scenario (in months)
EIR	Expected Improvement Rate of a test scenario

$MVEP$	Minimal Viable Experimental Platforms (combination of the most cost-effective test scenarios)
$wMa_k$	Relative weight of MAI parameter $k$
$UCI$	Usage Coverage Indicator (to measure the potential to satisfy important usage scenarios)
$EOSA$	Test Environment, Operator, Strategy, or Artifact (four categorical variables characterizing a test scenario)
$tX$	Test scenario $X$ composed of the modalities of EOSA variables
$MMa_i$	Average maturity for market $i$
$\bar{M}_i$	Average maturity for market assuming tests are conducted
$\Delta MMa_i$	Relative distance between the performance of the technology and the required performance (in percentage)
$gC_{tX}$	Global financial cost of test scenario $X$ (in euros)

2. For each  $FA$ , analyze and quantify the value buckets ( $VB$ ) or markets ( $Ma$ ) as the “frequent painful usage situations for which existing solutions are poorly or not at all efficient” (Yannou et al. 2016);
3. Compare markets in terms of their attractiveness and potential of economic value creation by assessing the Market Attractiveness Index ( $MAI$ );
4. Characterize the technology by modeling the Technology Abilities ( $TA$ );
5. Cross  $Ma$  and  $TA$  in a series of matrices (called DSM denoting Dependency Structure Modeling) and evaluate the required performance of the technology as well as its current maturity; ( $NB$ : the DSM matrices are illustrated by means of a case study in the following section);
6. Quantify (by integrating vectors of  $MAI$  and averaged  $TA$  in the case of required performances) the weighted meta-value buckets (i.e., combinations of  $Ma$  and  $TA$  where little effort is required to reach the required performance on the most attractive markets);
7. Model test scenarios (or experiments), their cost ( $C$ ), time ( $T$ ), and expected improvement rate ( $EIR$ );
8. Simulate test scenarios and their effectiveness on the identified meta-value buckets;
9. Optimize, for each market, the most cost-effective test scenarios or Minimal Viable Experimental Platforms ( $MVEPs$ ).

**RITHM: general process**

The RITHM process is intended to be implemented in technology startups, because it is conceived to diagnose and improve a technology designed for market. This process suggests a set of tools that can efficiently help reduce uncertainties before the launch of an innovative value offer. The RITHM process contains two major phases: (i) diagnosis and (ii) test and business strategy, and is outlined by the following steps (also depicted in Fig. 2):

1. Diagnose the main Fields of Activity ( $FA$ ) (applications of the technology);

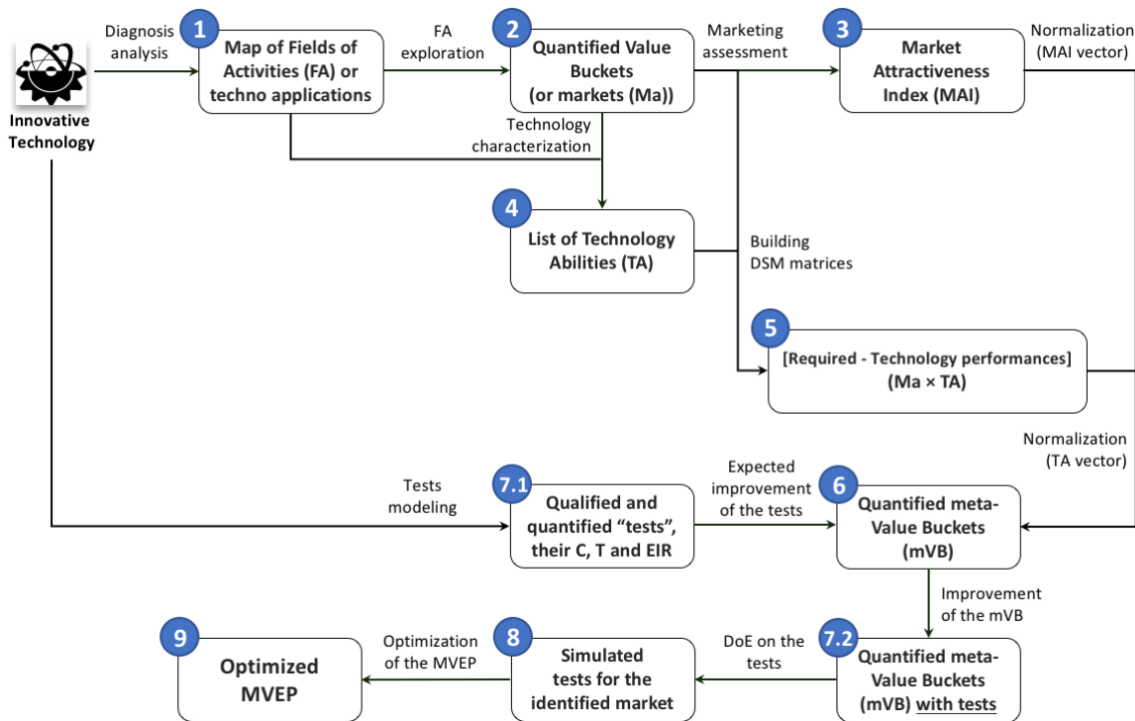
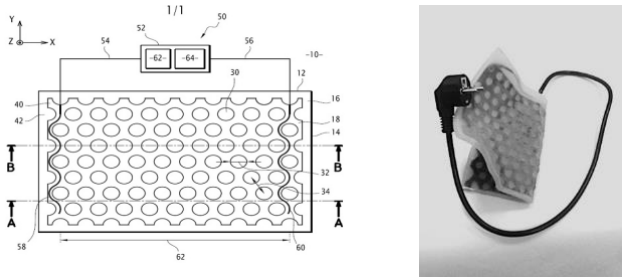

Figure 2. RITHM process

## RITHM CASE STUDY

The RITHM methodology is applied on a startup that has a patented technology to be exploited in different markets. This technology is a shape-changing plastic material that becomes flexible when plugged into a source of A/C current (see Fig. 3).



**Figure 3. Schematic presentation of a section of the prototype (left) and the physical prototype (right)**

The product is almost instantaneously deformable and reversible. It can be incorporated into daily objects and the user can adapt it to an expected shape. Some applications of this technology have already been identified by the company. However, they are merely based on the intuition of entrepreneurs of the startup and are identified on an ad hoc basis (see Fig. 4 for examples where the technology can be introduced to improve shape adaptation of objects).

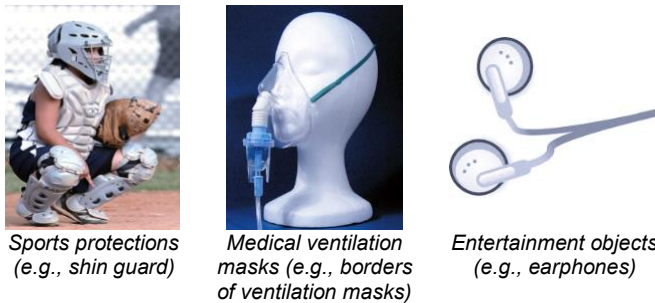

**Figure 4. Some of the identified applications by the startup developing the shape changing technology**

The **1<sup>st</sup> step** of the RITHM methodology is the identification of the fields of activities (FA) or applications of the technology. The latter is done by systematically exploring the fields where a shape changing technology can be applied, regardless of the type of market or the technological aspects of similar technological solutions. This exploration remains qualitative by going through the existing knowledge already acquired by the company and by systematically investigating the *Deep Knowledge* (Bekhradi et al. 2017) about *usage situations*, *users' pains*, and *existing solutions*.

A brainstorming session has been conducted with the startup founders and innovation coaches in their innovation incubator. The result of this session is a heuristic map that allowed categorizing the fields of activities (FA) of the

solution into two distinct FA classes: (i) *human body interface* (i.e., adaptation to the shape of the human body such as adapting to the shape of ears in earphones); (ii) *embedding and structuring objects* (i.e., without adaptation to the human body such as an internal part of an industrial machine without the need to adopt the shape of a part of the human body).

The **2<sup>nd</sup> step** consists in quantifying markets (or value buckets) of each identified application in the two FA classes. The DSM-Value Bucket (DSM-VB) algorithm of the RID methodology (Yannou et al. 2016, Lamé et al. 2017) allows quantifying these value buckets. This algorithm determines in a semi-automated manner the gap between two spaces: (*problems/pains* occurring in frequent "*usage situations*") and (overall effectiveness of the "*existing solutions*" to cope with "*problems/pains*" occurring in "*usage situations*"). Then, the algorithm enables the calculation of value buckets or the important problems occurring in frequent usage situations for which the existing solutions are not effective.

In our case, 21 value buckets are quantified and filtered. These value buckets are user problems related to different user activities. These value buckets contain valuable information on problems that are worthy of being addressed in the front end of innovation. Thus, the value buckets quantify technology improvements necessary for the technology to be successful in different targeted markets, instead of prototyping and iteratively testing without clear purpose.

For the sake of simplicity, we will consider only 5 of the 21 value buckets (called henceforth markets (*Ma*)):

- *Ma<sub>1</sub>*: cosmetic masks ("*poor oil distribution problem*" in the case of "*home usage*");
- *Ma<sub>2</sub>*: shin guard ("*injury and fracture*" in "*tackle receiving*");
- *Ma<sub>3</sub>*: ski boots ("*tiredness and musculoskeletal disorders*" in "*long-term use*");
- *Ma<sub>4</sub>*: orthopedic inserts ("*time and efficiency loss*" in "*customizing orthopedic soles*"); and
- *Ma<sub>5</sub>*: earphone ("*bad fitting in the ears*" during "*sport and in-movement situations*").

The **3<sup>rd</sup> step** deals with comparing these markets in terms of their attractiveness and potential of economic value creation. This is a typical marketing question: how can different markets be compared? What are the most relevant comparison indicators?

(Armstrong et al. 2014) discussed a set of techniques and indicators. (Best 2012) proposed a quantification tool to assess the Market Attractiveness Index (MAI). Based on these works, we propose a quantification technique to assess the MAI of an innovation technology. An intensity scale from 0 to 5 (with 5 as the most important or, for instance, the biggest or a very easily accessible market) is used to assess the value of each of the 6 parameters

categorized in 3 classes in Fig. 5. Each value is called  $Mk_i$ , where “ $i$ ” is a market index. The relative importance of each parameter is then weighted by using a 0 to 1 intensity scale ( $wMa$ ). All these values are determined by the company based on their market studies.

$wMa$ (between 0 to 1)	0,9	0,9	0,7	0,4	0,8	0,4
	Competitive intensity			Market access		
Market forces	Market size	Market potential (or, growth)	Ease of entry on the market	Likelihood to find potential investors	Customer acceptance of an innovation	Distribution channel access
Ma 1	5	5	2	5	4	4
Ma 2	4	5	3	2	4	4
Ma 3	3	4	5	4	5	5
Ma 4	3	4	3	3	2	4
Ma 5	5	5	1	4	4	4

Figure 5. MAI assessment for 5 markets of the shape changing technology

The weighted average of the values of the 6 parameters with their relative importance provides the MAI per market ( $MAI_i$ ):

$$MAI_i = \frac{\sum_{k=1}^n (Mk_i \times wMa_k)}{n} \quad (1)$$

The 4<sup>th</sup> step of the process involves a deep analysis of the technology through the identification of its underlying characteristics or abilities. A functional reasoning constitutes the basis of this analysis. As opposed to existing approaches that merely focus on the technical functions or technology affordances (see for instance (Gaver 1991)), we emphasize the broader concept of usage situations and the possible usage coverage indicators of a technology as proposed and quantified by (Wang et al. 2013, Yannou et al. 2013). Therefore, an ontology (i.e., a generic technology characterization) is proposed to identify the key abilities of the technology (see Fig. 6). In this model, it is considered that a technology can be applied to different fields of application, where *characteristic painful usage scenarios* are to be covered by a set of expected usage coverage properties. These properties can be modeled through Usage Coverage Indicators (UCIs) that have been proposed to measure the potential to satisfy usage scenarios.

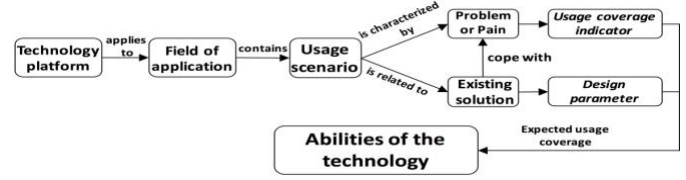

Figure 6. Ontology of Technology Abilities (TA)

This ontology is holistic in that it does not only specify technical attributes of existing solutions on the market, but it starts from a representative set of fields of applications and then usage scenarios instead of being focused on (or fixed at) design parameters of a solution that are, at best, based on functional analysis.

In our case study, 14 TAs are identified and thoroughly defined. For the rest of this study, 3 key TAs are kept and analyzed in the DSM-meta value bucket matrices. These TAs are:  $TA_1$ : *ability to cover bony parts of the human body*;  $TA_2$ : *heat setting*; and  $TA_3$ : *practicality in terms of volume and portability*.

The dependencies between Markets and Technology Abilities are represented in the DSM matrices that are built in the 5<sup>th</sup> and 6<sup>th</sup> steps of the RITHM process. These matrices are explained in the following sub-section.

#### DSM-meta value bucket (DSM-mVB) algorithm

Once the value buckets (here called markets ( $Ma$ )) and technology abilities ( $TA$ ) are identified, the DSM algorithm calculates the difference between required and current performances of the technology, and identifies the meta-value buckets as detailed through matrices  $F$ ,  $G$ ,  $H$ , and  $K$  in Fig. 7.

The  $H$  matrix is normalized through two weighting vectors entailing the calculated market attractiveness index ( $MAI$ ) and the averaged required technology abilities. This normalization enables to capture the rationale of each market importance and the abilities of the technology.

In parallel, tests are modeled by combining a set of modalities of 4 generic categorical variables (test artifact, environment, operator (or user) and strategy). The cost ( $C$ ), time ( $T$ ), and expected improvement rate ( $EIR$ ) of each test is assessed based on startup’s previous tests and/or innovation and technology experts’ input.

Subsequently, design of experiments (DoE) is used as a support technique to generate  $H'$  matrices for all of the possible combinations of the modalities of test variables (e.g., an iteration could be: conducting a “parallel”; “field test”; with “end-users”; on the “Physical Prototype”).

After all possible iterations, the algorithm identifies the most cost-effective test(s) per market. These tests are called minimum viable experimental platform (MVEP), as it allows a startup to conduct an experiment that “platformize” a set of modalities of tests that can significantly improve the technology for the most promising markets.

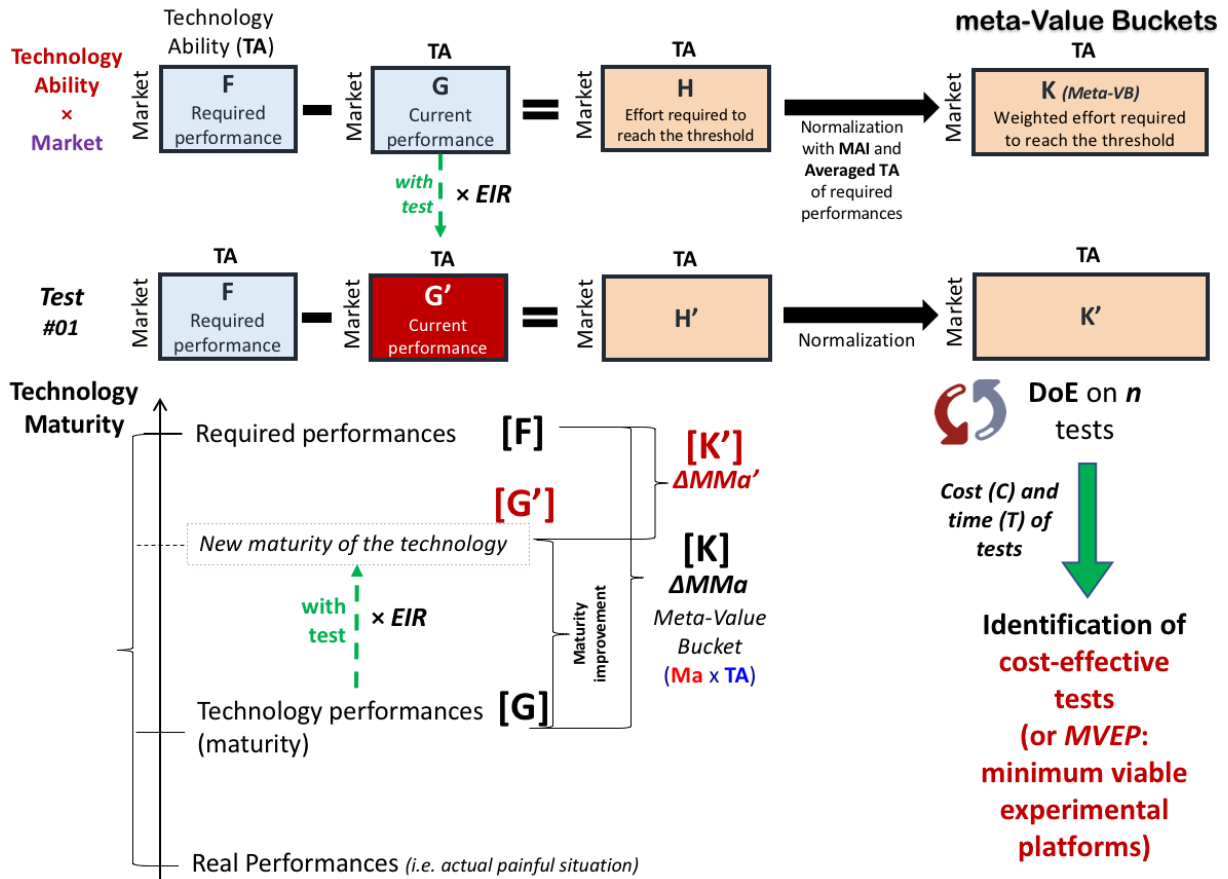

Figure 7. The DSM-mVB data streaming and calculations

The matrix F (see Fig. 8) reflects the required performances of the technology. This could be for instance the threshold level of a given performance at which a successful technology is already released or can be approved for commercialization (as is the case with FDA-regulated medical technologies).

<b>F</b>	TA <sub>1</sub> ) Ability to cover bony parts of the human body	TA <sub>2</sub> ) Heat setting	TA <sub>3</sub> ) Practicality in terms of volume and portability
Ma <sub>1</sub> ) Cosmetic Masks	4	4	3
Ma <sub>2</sub> ) Shin Guard	5	0	0
Ma <sub>3</sub> ) Ski Boots	5	5	5
Ma <sub>4</sub> ) Orthopedical insert	5	2	5
Ma <sub>5</sub> ) Earphones	4	0	5
<b>Average required TA</b>	<b>4,60</b>	<b>2,20</b>	<b>3,60</b>

Figure 8. Required performances matrix

The data in each cell of this matrix relates the importance or the expected maturity of TA in a given market on an intensity scale from 0 to 5. If the value is 0 it means that the TA is not important at all in the market; if the value is equal to 5, then the ability is essential to the market. The data to complete this matrix are obtained through different complementary sources: (i) existing standards that a technology must comply with (a literature review of the standards of each market is therefore mandatory); (ii) discussions with different experts who have an extensive knowledge about both markets and technologies; (iii) startup's knowledge and experience.

The averaged calculated TA shows the required level of a given TA for all markets. In the next steps of the RITHM methodology this average will be weighted by considering the relative importance of TA for the company in terms of its technology development strategies.

The second DSM-mVB matrix G reflects current performances of the technology. The intensity scale is also from 0 to 5 for expressing the extent of the current performances of TA in different markets.

The third matrix H represents intrinsic meta-value buckets, and arises from the subtraction of matrix G from matrix F. The normalized matrix K is then obtained by



$$K_{ij} = H_{ij} \times MAI_i \times F_j. \quad (2)$$

A last matrix called “maturity level” is computed based on matrix K. In this manner, the DSM-mVB algorithm determines the percentage of the technology maturity degree:

$$M_{ij} = 1 - \left( \frac{H_{ij}}{\text{Max}_{tm}(H_{tm})} \times \frac{MAI_i}{\text{Max}(0;5)} \times \frac{F_j}{\text{Max}(0;5)} \right). \quad (3)$$

The 7<sup>th</sup> step focuses on the possible generic test scenarios (or experiments) to be conducted by the startup company. These test scenarios are supposed to be generic as they are not specific to a given market. Besides, they are characterized before being conducted even though the company has already carried out such tests. Indeed, the objective of the RITHM methodology is to extrapolate and plan the future test scenarios aiming at improving the technology to be put on a promising market.

Each test scenario is considered as a combination of modalities of 4 generic categorical variables. The term “scenario” seems appropriate since it is a combination of several modalities. The identified variables here are common to all experiments and are generic to all types of experimentation activities as defined in (Cooper 2011, Radder 2003). These categorical variables are *EOSA* for *test Environment*, *test Operator*, *test Strategy*, and *test Artifact*. These variables are not intended to be mutually exclusive. Each variable contains a set of 3 to 5 modalities with a last modality of “Other” that can be specified to a given case (see Table 1).

**Table 1. EOSA variables and modalities of a test**

Variable	Modality
<b>Environment (E)</b>	<i>E1: Real-life situation</i>
	<i>E2: Traditional lab (simulated situation)</i>
	<i>E3: Web-based lab</i>
	<i>E4: Other</i>
<b>Test operator (O) or user</b>	<i>O1: Real end-users</i>
	<i>O2: Simulating Users</i>
	<i>O3: Engineers</i>
	<i>O4: Other</i>
<b>Test Strategy (S)</b>	<i>S1: Blind or double-blind tests</i>
	<i>S2: Test and control group</i>
	<i>S3: Parallel test</i>
	<i>S4: Sequential test</i>
	<i>S5: Other</i>
<b>Test Artifact (A)</b>	<i>A1: Physical prototype</i>
	<i>A2: Software modules</i>
	<i>A3: Other</i>

Each test scenario is thus modelled through a combinatorial mechanism of the distinct modalities of variables knowing that the modalities of a given variable are assumed to be mutually exclusive and cannot be

combined. A test scenario could be expressed by 1 modality of 1 variable or 2, 3, or 4 modalities coming from different variables.

In the following, 5 test scenarios are maintained for the sake of this case study. These test scenarios are combinations of modalities of a part or all of the EOSA variables (see Table 1):

- **tA:** *Building physical prototypes to be tested in the lab (such as alpha tests or clinical trials in the case of medical technologies): [A<sub>1</sub>; E<sub>2</sub>]*
- **tB:** *Numerical simulations on the robustness of materials: [A<sub>2</sub>; S<sub>3</sub>]*
- **tC:** *Blind testing the prototype with real users in real-life situations: [S<sub>1</sub>; O<sub>1</sub>; E<sub>1</sub>]*
- **tD:** *Testing the physical prototype with real users in real-life situations following a test and control technique [A<sub>1</sub>; O<sub>1</sub>; E<sub>1</sub>; S<sub>2</sub>]*
- **tE:** *Randomized field trials of the physical prototype in simulated situations [S<sub>3</sub>; A<sub>1</sub>; E<sub>2</sub>].*

Following this combinatorial system, the estimated financial cost (C), time (T), and expected improvement rate (EIR) of each test can be expressed more easily by a startup company. The time is then approximately monetized to calculate a global cost (gC).

The EIR is given either for combination of market and TA, or it can be expressed as an average for a given market or for a given TA. Subsequently, based on the EIR per (market × TA) or in average for a market or a TA, the algorithm computes the modified performances of the technology if the tests are conducted. In this step, modified meta-value buckets (K matrix) are quantified by weighting the obtained H matrix (i.e. subtraction between the two matrices of “required performances” and the “modified performances of the technology”). Consequently, a new maturity level matrix (M) is also computed that allows calculating the average maturity per market  $MMa_i$ , since the focus will be on the markets and the impact of test scenarios on them. A new indicator can thus be calculated following Eq. (4). This indicator ( $\Delta MMa_i$ ) characterizes the distance between the performances of the technology and the required ones.

$$\Delta MMa_i = 1 - \bar{M}_i, \quad (4)$$

where  $\bar{M}_i$  is the average maturity per market in the case where the tests are conducted. This indicator is calculated for all of the 5 identified test scenarios (tA to tE) and for 5 identified markets. In this case, there will be 25 test scenarios on the identified markets. If value of  $\Delta MMa_i$  for a given test scenario is zero or negative, it must be interpreted that this test scenario allows the company to reach this market.

An important hypothesis here is that the relative costs of test scenarios are considered as not identical. There is

always a slight difference between of tests, otherwise there will a same cost for different impact on the ( $\Delta MMA_i$ ). Since the costs are estimated in advance and they are identified in an interval with 5% error, this hypothesis is conceivable.

The 8<sup>th</sup> step of the RITHM methodology consists in simulating the possible test scenarios for the identified markets in order to capture the test scenario that allows reducing  $\Delta MMA_i$  while not being costly or time consuming. In Fig. 9, the 5 test scenarios ( $tA$ ,  $tB$ ,  $tC$ ,  $tD$  and  $tE$ ) are plotted for the second identified market of this case study.

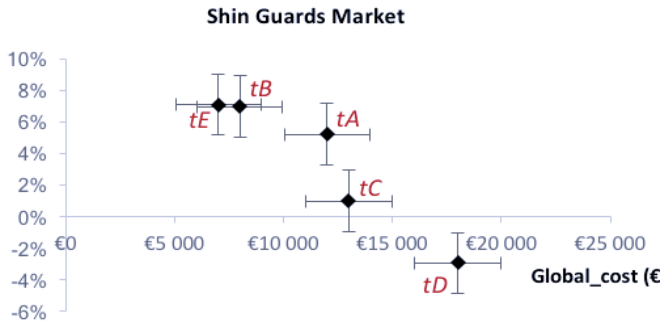

Figure 9. Example of 5 identified tests for the second identified market

The fifth test scenario ( $tD$ ) turns out to be the most effective scenario that allows to reach the shin guards market for the company while costing almost 18k€. However, at the time of this simulation, the available funds of the startup are less than 15k€. Therefore, this test cannot be conducted until the company raises more funds. This type of result enables startup companies not only to define more robust technology and market roadmaps, but also to provide structured arguments in terms of technology development to investors.

Another result, which is not detailed in this paper, is the Minimal Viable Experimental Platforms (MVEP) that includes one or several test scenarios on one or several markets. A set of clustering rules can be identified following the company strategies, priorities and available resources and even willingness to develop conduct a set of tests in priority. These MVEPs are obtained based on all of the possible test scenarios for all markets as depicted in Fig. 10.

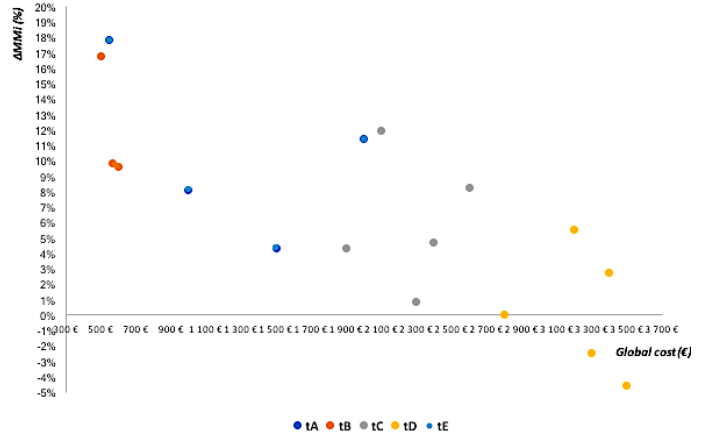

Figure 10. Global cost and  $\Delta MMA_i$  for 25 test scenarios

The 9<sup>th</sup> step of the RITHM methodology deals with identifying Pareto-optimal MVEPs. This step is not detailed in this paper and is the subject of future research. Meanwhile, we may be reasonably confident in claiming that there would exist some commonalities among the Pareto-optimal MVEPs which will ensure their optimality. These similarities can originate in the overall fund-raising and investment strategies and priorities of the startups.

This optimization problem is formulated as “**minimize the gap between current and required performances to successfully penetrate promising market(s) by conducting the most cost-effective set of MVEPs.**” The objective function of this optimization problem is given by:

$$\begin{aligned} \text{Min } y &= \Delta MMA_i \\ \text{s. t.} & \\ \left\{ \begin{array}{l} \exists MMA_i: \Delta MMA_i \leq 0 \quad (i = 1 \text{ to } n) \\ \sum gC_{tx} \leq (\sum \text{funds to be raised} + \sum \text{estimated available time}) \end{array} \right. & \quad (5) \end{aligned}$$

where  $gC_{tx}$  is the global financial cost of a given test scenario. The objective function can be depicted in Fig. 11: reduce the distance between the performances of the technology and the required ones on different markets. This objective is accomplished once at least one promising market is successfully penetrated.

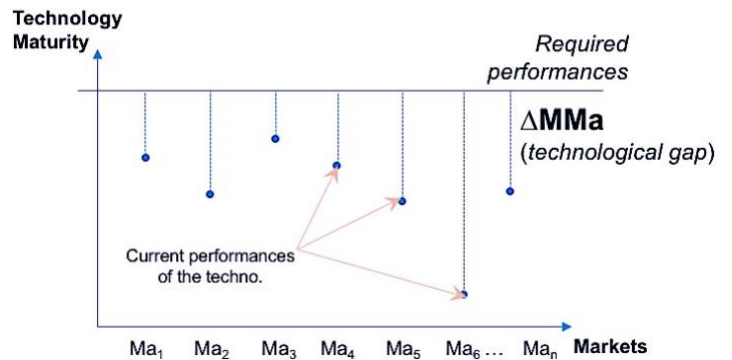

Figure 11. RITHM assessment

## Data collection and validation of the final results

The data used in the RITHM process are collected from different sources such as review of the existing documents on potential markets and technologies, company previous tests and obtained results, agile-rapid iterative micro-tests to capture data for future tests, observations of usage situation, interviews with users and test operators in other companies, and a set of heuristics based on entrepreneurs' intuition following brainstorming sessions (for instance to make a map of Fields of Activities (FA) in the first step of the RITHM process).

All of the above-mentioned elements are confirmed by innovation experts that are startups' coaches and mentors with a solid knowledge of different markets and technologies. Even though it can be argued that experts can sometimes be subjective, it should be noted that each expert is questioned in accordance with their specialization and field-related knowledge. Moreover, the accuracy of the collected data (necessary mainly for establishing the 0 to 5 intensity scales) is not an issue in the RITHM process since the relative importance of the matrices and meta-value buckets matters more than their intrinsic values.

The final results of the RITHM methodology are checked by means of one or several of the following:

- If available, comparison with historical data on tests already conducted by the startup;
- Comparing the tests with those already performed by a similar startup with similar technology and conditions;
- Both sets of recommended and not-recommended test scenarios by the RITHM methodology are carried out by startups to assess the significance of the results;
- Experts' confirmation based on their previous knowledge of similar startups;
- Startup's general appreciation and intuition: the final results reaffirm the test scenarios and markets that have been already targeted by the company. Thus, decision-making support is provided to the startup.

## CONCLUSIONS

Effectuation-based entrepreneurial approaches (e.g., (Blank 2013, Osterwalder and Pigneur 2010, Ries 2011)) assert that innovation is a "non-linear" process along with "conditions of extreme uncertainty," which makes it impossible to be planned, as advocated by traditional business forecasting approaches. This allegation might be true when a startup focuses on planning its business by forecasting unverifiable ROI and expected profit. This is not only a time-consuming process, but also a fairly inaccurate one due to inherent uncertainty and lack of information about customers and their willingness to pay. Nonetheless, there is a decision-making need regarding where to start to develop and test a technology, what to test, and for whom (in which market context). The existing entrepreneurial approaches do not provide relevant answers. Establishing the culture of experimentation

through iterative and lean tests is certainly useful, but it is not sufficient to provide relevant decision-making support leading to target the most promising markets and to reduce waste. Engineering design approaches such as DoE and robust engineering (Fisher 1937, Taguchi et al. 2005) may be useful for providing an answer. However, this answer does not incorporate marketing and business implications of a technology systematically.

We claim through this study that it is possible, perhaps even mandatory, to define structured R&D roadmaps from the front end of innovation and in the context of an innovative technology startup when resources are rather limited. An innovation, by definition, is related to uncertainty. It is therefore necessary to reduce and manage this uncertainty systematically. The proposed RITHM methodology is a model-based innovation approach that provides useful information for investment decision support, helping startups target the most promising markets by testing and improving their technology. RITHM helps startup companies, based on quantitative information, manage risk in innovation and enhance the R&D process leading to design viable business models.

Even though RITHM has been applied to several innovative startup cases in France and Canada, it is not without shortcomings. There is an important lack of reliable data to validate the final results obtained by using RITHM. The difficulty relies on the fact that startup companies do not necessarily express a test scenario as characterized in the RITHM methodology. For the time being, there is also a lack of historical data or *a posteriori* data (after running test scenarios) to statistically validate the significance of the final results. Nevertheless, such results are new in the context of startups to build first technology and R&D roadmaps. Therefore, the intermediate and final results of RITHM are original and are of keen interest to startup companies and their innovation coaches. In the context of startup companies, there is generally no plan for organizing experimentation activity. The results of RITHM provides such a plan. Besides, the tools of RITHM enable companies to monitor their R&D activities in a more organized manner by keeping a traceability of different design activities, such as knowledge exploration, problem design, test, and validation.

The focus of our future research is on the optimization of test scenarios and test platforms (or MVEPs) by means of mixed variable programming (Kokkolaras et al. 2001).

Further applications of the RITHM can be carried out with larger technology-driven companies. This application would be easier, since in larger companies the data from previous test are, in most cases, captured and managed.

## ACKNOWLEDGMENTS

The authors wish to thank startup companies in Paris and in Montreal and their coaches in innovation incubators who helped us verify the intermediate and final results of

the RITHM methodology. The partial support of the first author through MITACS Globalink grant IT08957 is greatly appreciated.

## REFERENCES

Armstrong, G., S. Adam, S. Denize, and P. Kotler. 2014. *Principles of Marketing*: Pearson Australia.

Bekhradi, A., B. Yannou, F. Cluzel, and T. Vallette. 2017. "Categorizing user pains, usage situations and existing solutions in front end of innovation: The case of smart lighting project." The 21st International Conference on Engineering Design, ICED17, Vancouver, British Columbia, Canada, August 21-25.

Bekhradi, A., B. Yannou, F. Cluzel, F. Chabbert, and R. Farel. 2015. "In vivo in Situ experimentation projects by innovative cleantech start-ups in Paris." ASME. International Design Engineering Technical Conferences and Computers and Information in Engineering Conference, Volume 2B: 41st Design Automation Conference, Boston, Massachusetts, USA, August 2–5, 2015. doi: 10.1115/DETC2015-47631.

Best, R.. 2012. *Market-based Management*. Pearson Higher Ed.

Blank, S.. 2013. *The Four Steps to the Epiphany: Successful Strategies for Products That Win*: BookBaby.

Boehm, B.. 2002. "Get ready for agile methods, with care." *Computer* 35 (1):64-69.

Cooper, R.G. 1990. "Stage-gate systems: a new tool for managing new products." *Business Horizons* 33 (3):44-54.

Cooper, R.G. 2011. *Winning at New products: Creating Value through Innovation*: Basic Books (AZ).

Deeds, D.L. 2001. "The role of R&D intensity, technical development and absorptive capacity in creating entrepreneurial wealth in high technology start-ups." *Journal of Engineering and Technology Management* 18 (1):29-47.

Fisher, R.A. 1937. *The design of experiments*: Oliver And Boyd; Edinburgh; London.

Forsberg, K., and H. Mooz. 1999. "Systems engineering for faster, cheaper, better." INCOSE International Symposium.

Frederiksen, D.L., and A. Brem. 2017. "How do entrepreneurs think they create value? A scientific reflection of Eric Ries' Lean Startup approach." *International Entrepreneurship and Management Journal* 13 (1):169-189.

Gaver, W.W. 1991. "Technology affordances." Proceedings of the SIGCHI Conference on Human factors in Computing Systems.

Highsmith, J., and A. Cockburn. 2001. "Agile software development: The business of innovation." *Computer* 34 (9):120-127.

Jaruzelski, B., V. Staak, and A. Shinozak. 2016. "Global Innovation 1000 : Software-as-a-Catalyst, The world's largest innovators are shifting the focus of their R&D investments from products to programming." *Strategy+Business*, Winter 2016.

Kim, W Chan, and Renee A Mauborgne. 2014. *Blue ocean strategy, expanded edition: How to create uncontested market space and make the competition irrelevant*: Harvard Business Review Press.

Kokkolaras, M., C. Audet, and J.E. Dennis, Jr. 2001. "Mixed variable optimization of the number and composition of heat intercepts in a thermal insulation system." *Optimization and Engineering* 2 (1):5-29.

Lamé, G., Y. Leroy, and B. Yannou. 2017. "Ecodesign tools in the construction sector: Analyzing usage inadequacies with designers' needs." *Journal of Cleaner Production* 148:60-72.

Mankins, J.C. 1995. "Technology readiness levels." *White Paper*, NASA, Office of Space Access and Technology, April 6.

Osterwalder, A., and Y. Pigneur. 2010. *Business Model Generation: A Handbook for Visionaries, Game Changers, and Challengers*: Wiley.

Osterwalder, A., Y. Pigneur, G. Bernarda, A. Smith, and T. Papadacos. 2015. *Value Proposition Design: How to Create Products and Services Customers Want*: Wiley.

Radder, H. 2003. *The Philosophy of Scientific Experimentation*: University of Pittsburgh Pre.

Ries, E. 2011. *The Lean Startup: How Today's Entrepreneurs Use Continuous Innovation to Create Radically Successful Businesses*: Crown Publishing Group.

Sobek, D.K, A.C. Ward, and J.K. Liker. 1999. "Toyota's principles of set-based concurrent engineering." *Sloan Management Review* 40 (2):67.

Taguchi, G., S. Chowdhury, and Y. Wu. 2005. *Taguchi's Quality Engineering Handbook*. Vol. 1736: Wiley Online Library.

Thomke, S.H. 2003. *Experimentation matters: unlocking the potential of new technologies for innovation*: Harvard Business Press.

Ulrich, K., and S. Eppinger. 2015. *Product Design and Development*: McGraw-Hill Higher Education.

Wang, J., B. Yannou, F. Alizon, and P.-. Yvars. 2013. "A usage coverage-based approach for assessing product family design." *Engineering With Computers* 29 (4):449-465.

Wu, J.J., and R. Atkinson. 2017. "How Technology-Based Start-Ups Support US Economic Growth.", Information Technology & Innovation Foundation, November 2017, [https:// http://www2.itif.org/2017-technology-based-start-ups.pdf](https://http://www2.itif.org/2017-technology-based-start-ups.pdf).

Yannou, B. 2015. "Supporting need seeker innovation: the Radical Innovation Design methodology." International Conference on Engineering Design (ICED).

Yannou, B., F. Cluzel, and R. Farel. 2016. "Capturing the relevant problems leading to pain and usage driven innovations: the DSM Value Bucket algorithm." *Concurrent Engineering: Research and Applications*:1 - 16. doi: 10.1177/1063293x16666311.

Yannou, B., P.-A. Yvars, C. Hoyle, and W. Chen. 2013. "Set-based design by simulation of usage scenario coverage." *ASME Journal of Engineering Design* 24 (8):575-603.