

Research activities on Antenna Design in Nantes France

Tchanguiz RAZBAN

ICCS 2017 (Pilani, India)

- 0 Presentation of IETR (our Lab)
- 1 Wide Band Dual-Polarized Antenna
- 2 Satellite Receiver Antenna
- 3 Transparent Antenna
- 4 Reduced Size Base-Station Antenna

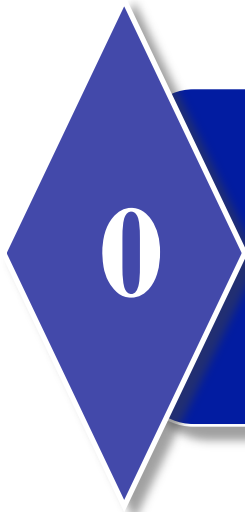

IETR:

Institute of Electronics & Telecommunications of Rennes

A Multi-sites Lab

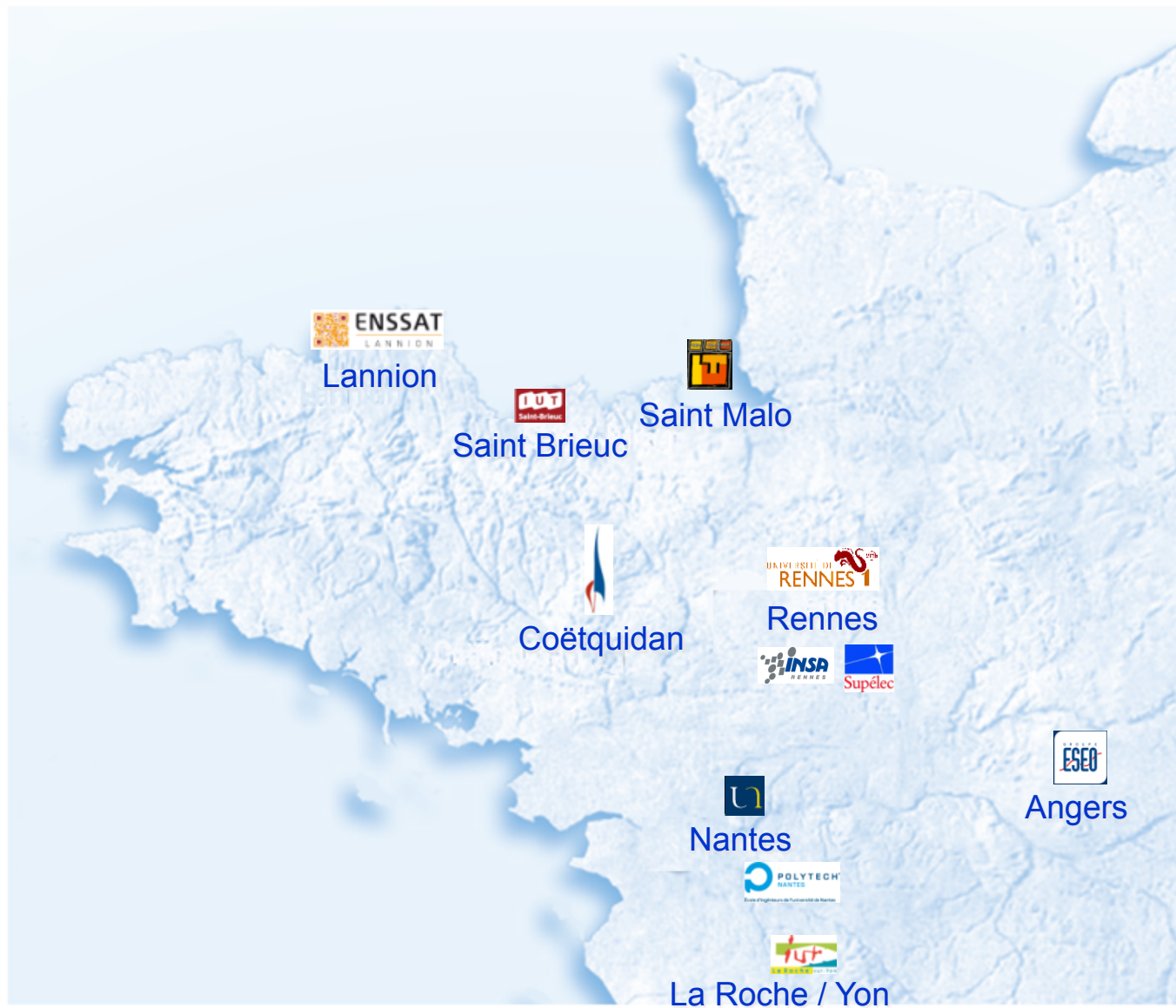

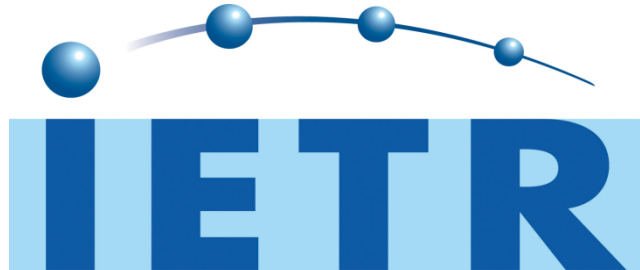

- Lecturers and researchers : 120
- Administrative and technical staff : 40
 - PhD students : 150
- Post-doctoral fellows, Research Engineers : 40
 - Invited researchers : \approx 80

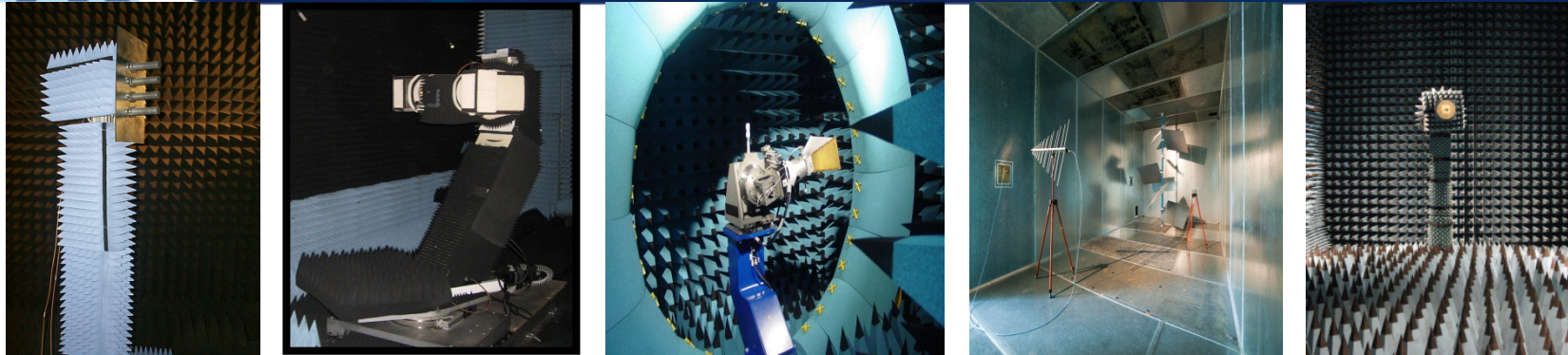

Up to 110 GHz

- ANECHOÏC CHAMBER 1 - 18 GHz – University of Rennes 1
 - ANECHOÏC CHAMBER 1 - 18 GHz – Polytech' Nantes
 - NEAR-FIELD CHAMBER 0,8 - 6 GHz – INSA of Rennes
 - R.C.S CHAMBER 1 - 40 GHz – INSA of Rennes
- ANECHOÏC CHAMBER 26,5 - 110 GHz – University of Rennes 1
 - REVERBERATING CHAMBER – INSA of Rennes
- ELECTRONIC MICROSCOPE SCANNING - IUT of Saint-Brieuc
 - X DIFFRACTOMETER - IUT of Saint-Brieuc
 - CLEAN ROOM – University of Rennes 1
 - EXPERIMENTAL STATION in Monterfil

□ 1GHz-20 GHz

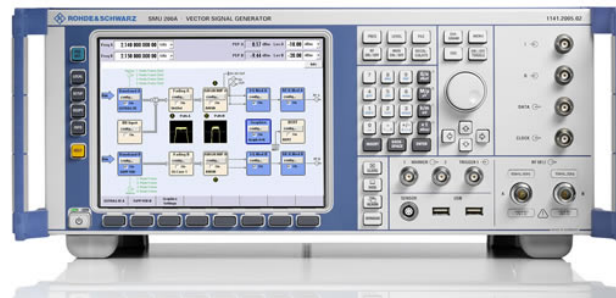
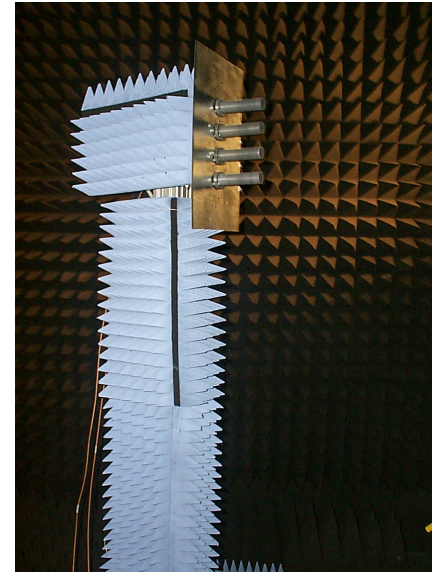
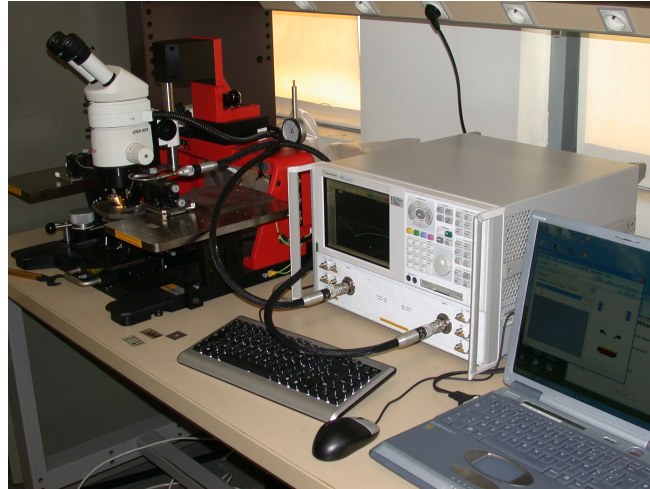

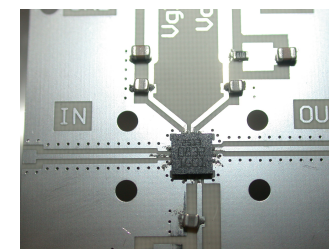
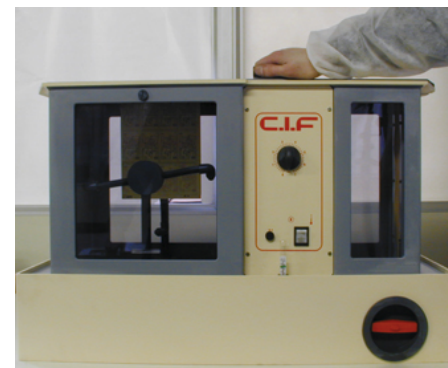



1

Wide Band Dual-Polarized Antenna

Industrial Research Project

Objectives:

- Very wide band (300 MHz to 3 GHz)
- Dual polarization (Horizontal & Vertical)
- Limited dimension (40 cm *40 cm)

Applications:

- Receivers for transmission survey
- Civil & Military

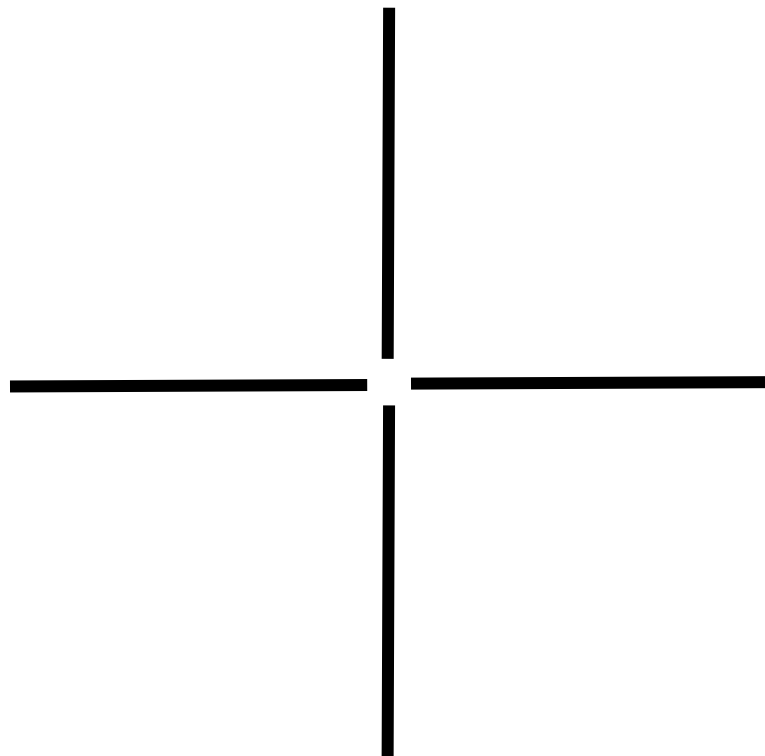

Two Dipole Antennas
For double polarization

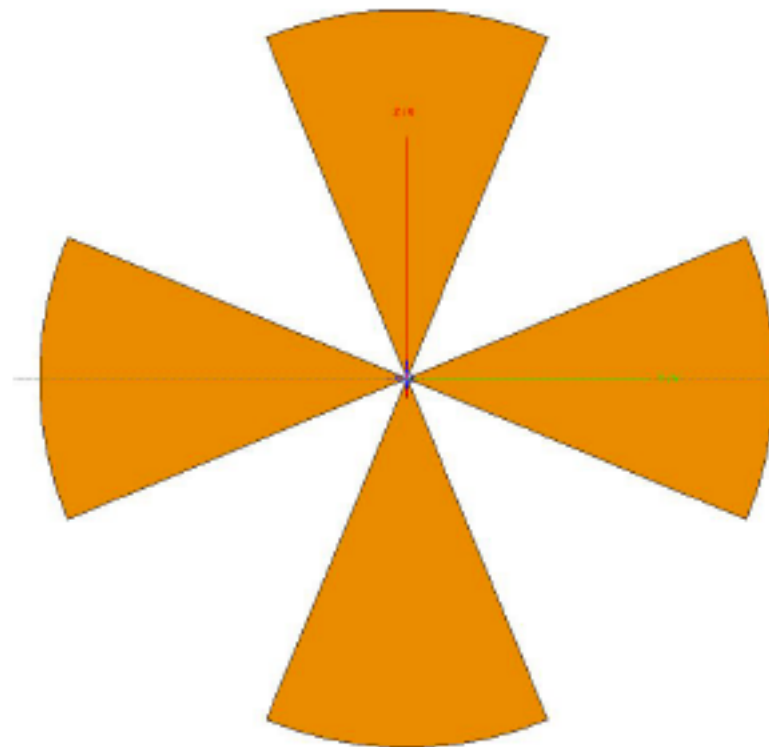

Butterfly Antenna
(Papillon)

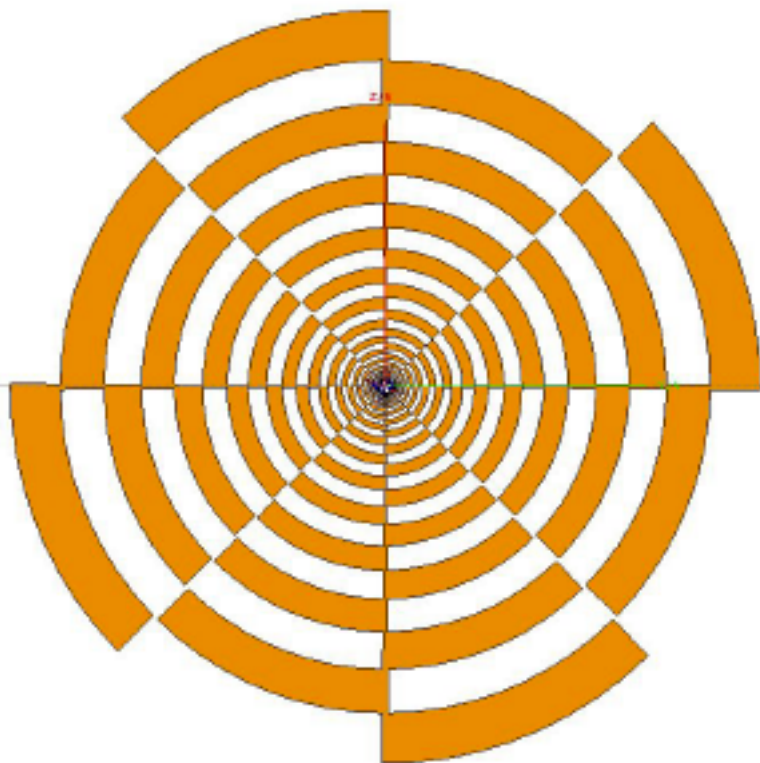

Dental Log-periodic
Antenna (DLP)

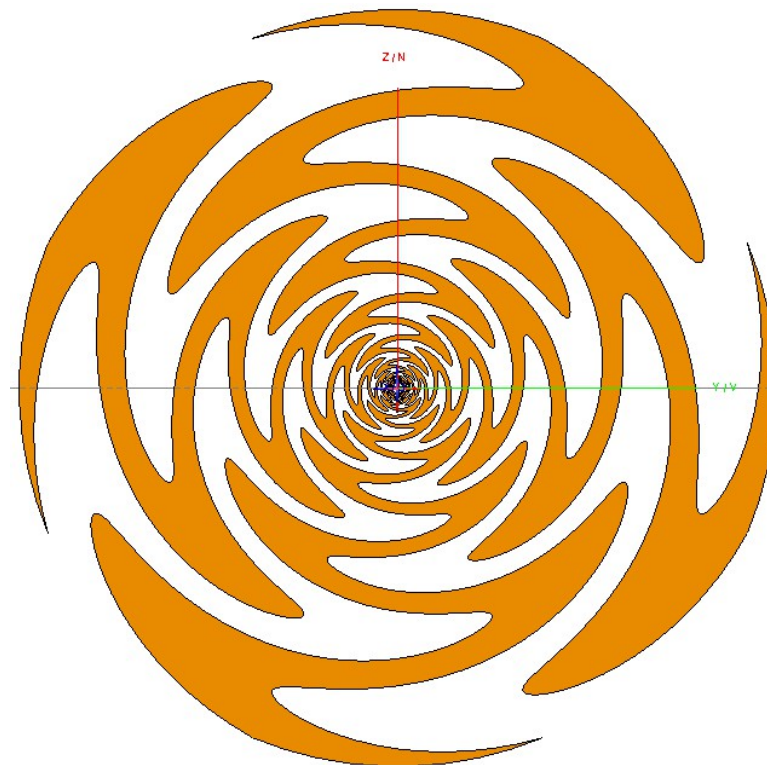

Sinueuse Antenna
(Sinueuse)

Simulation Results

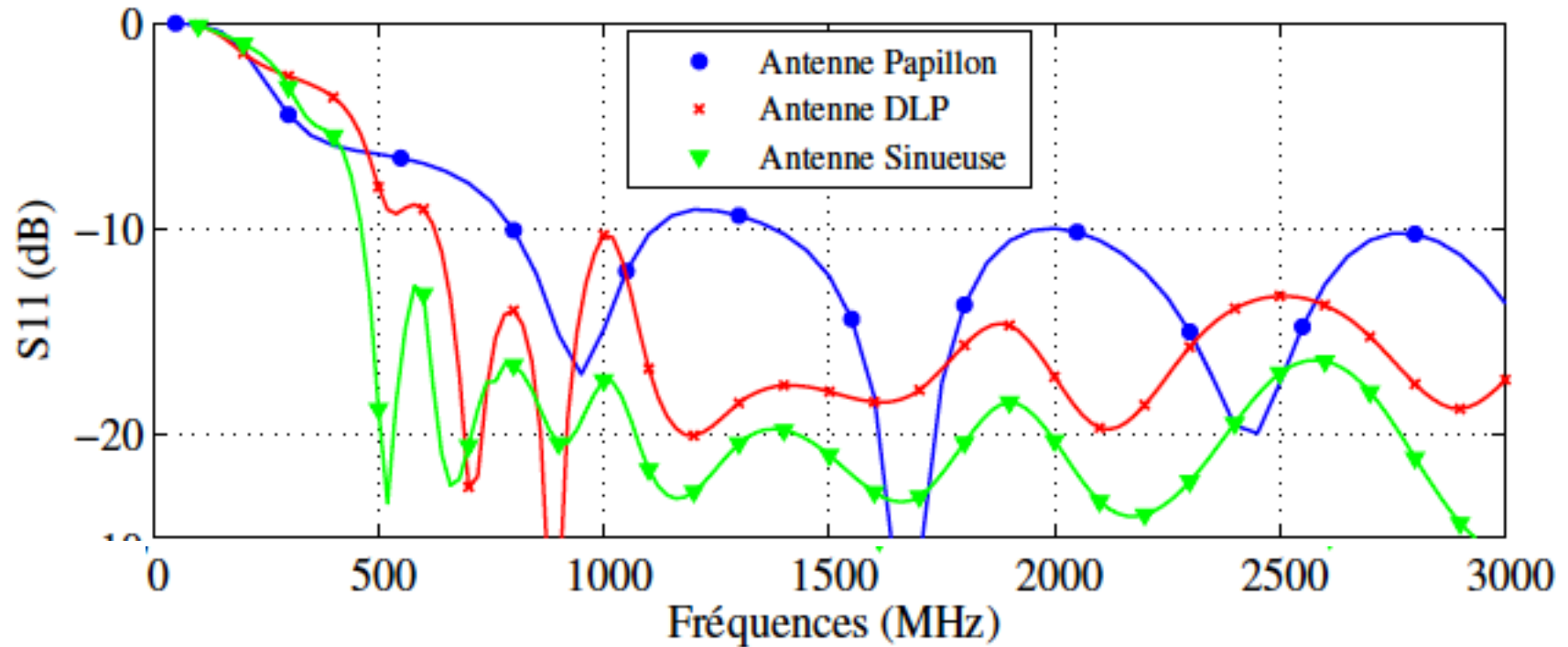

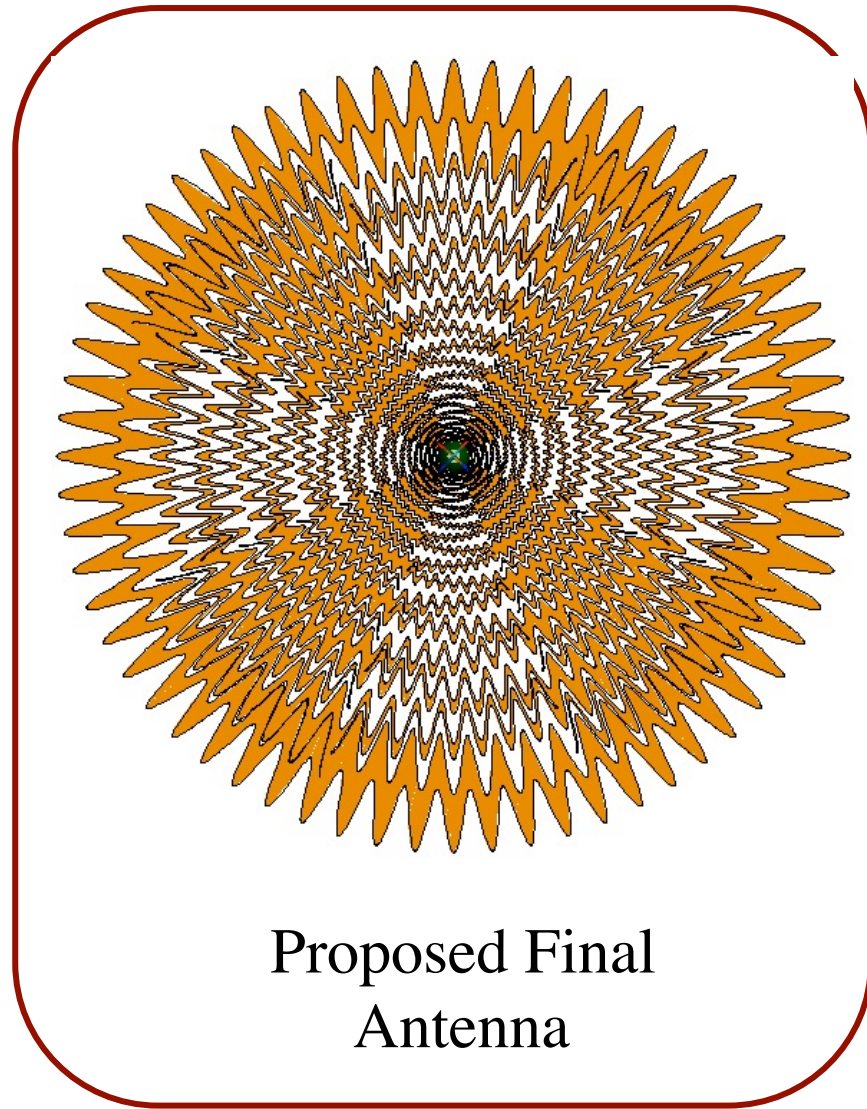
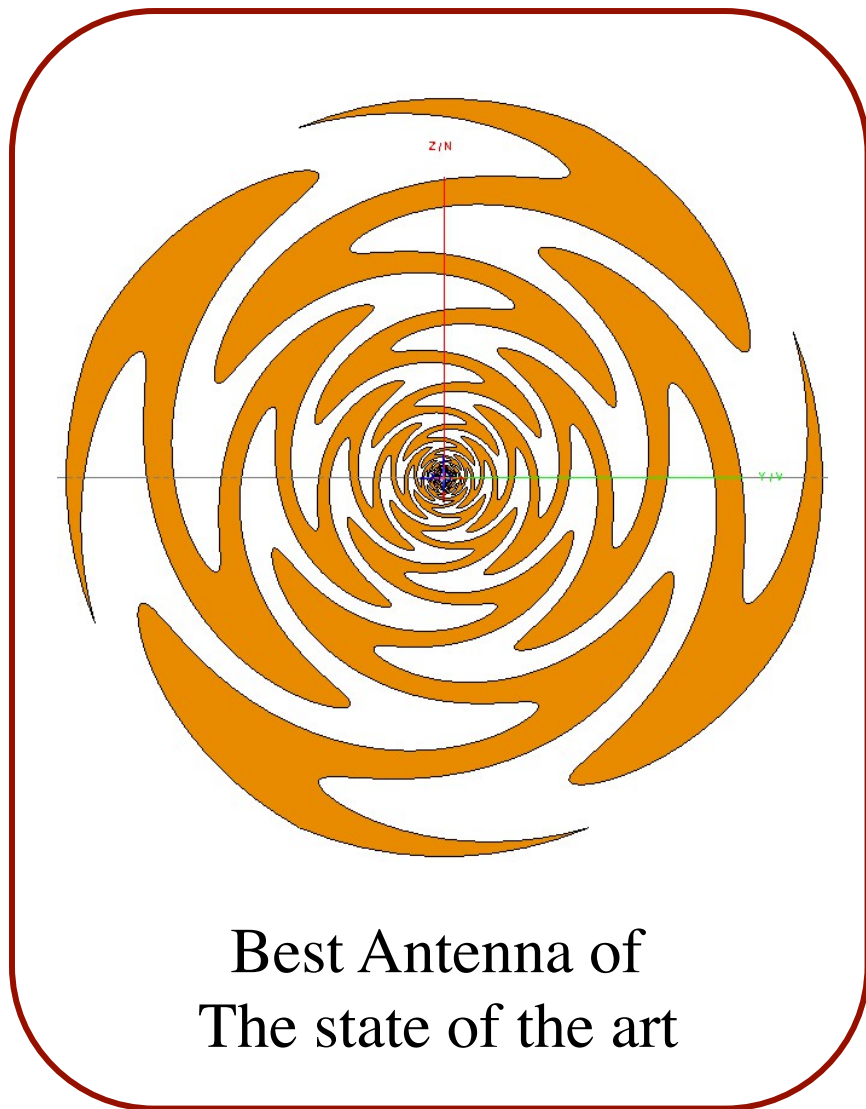

Final Result: 300-3000 MHz

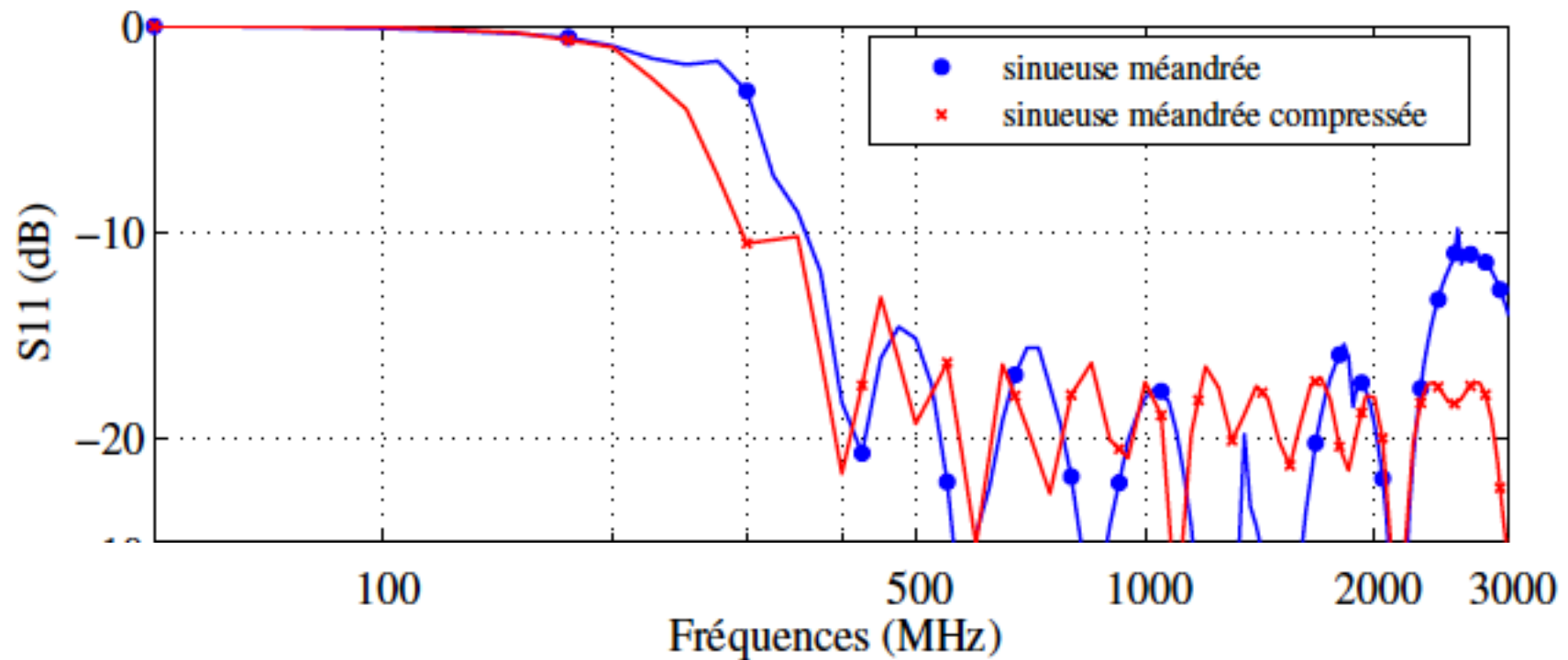

Realization and
Measurement

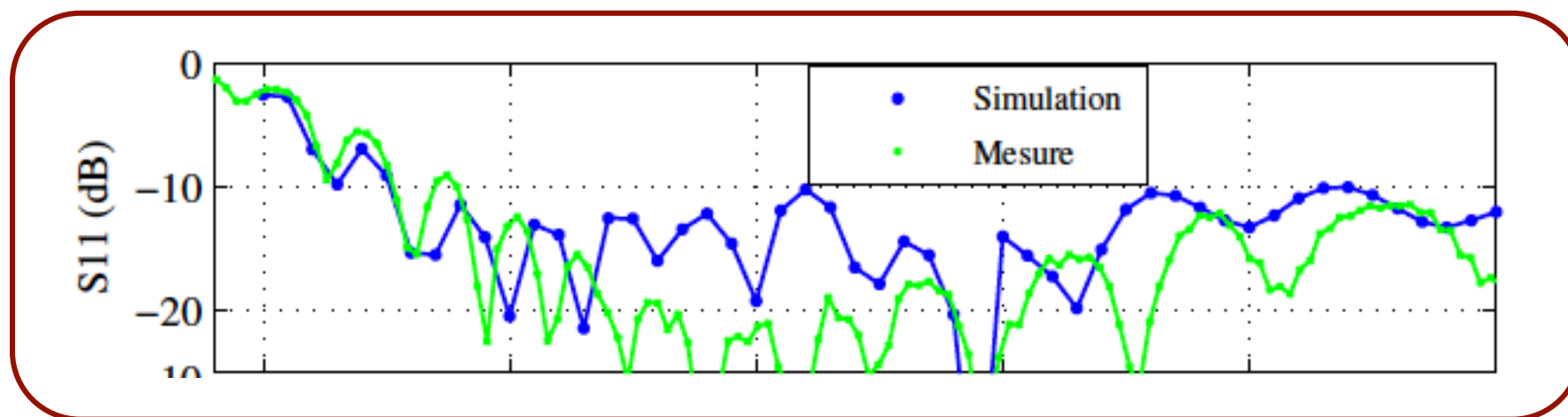

2

Satellite Receiver Antenna





Schwaiger 1 satellite

Dimensions: 55 x 62 cm

Single LNB

Gain: 34 dB

Fixed Position Antenna

For one receiver

Price from 40 €



Selsat parabole plate 1 satellite

Dimensions: 60 à 65 cm

Single Integrated LNB

Double polarization

Gain : 34,5 dB à 12,7 GHz

For one receiver

Price from 200 €

Flat, Discrete, Beam Switchable Antenna

Requirements :

- Wide band : 10.7 to 12.7 GHz
- High gain : 30 to 35 dB (>20 dB)
- Double polarization : Horizontal & Vertical
- Low cross polarization < -20dB

Begin with a Rectangular Patch

W= 9.622 mm
L= 6.623 mm

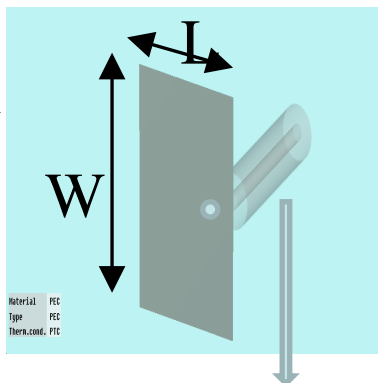

Méthode d'excitation:
Câble coaxial

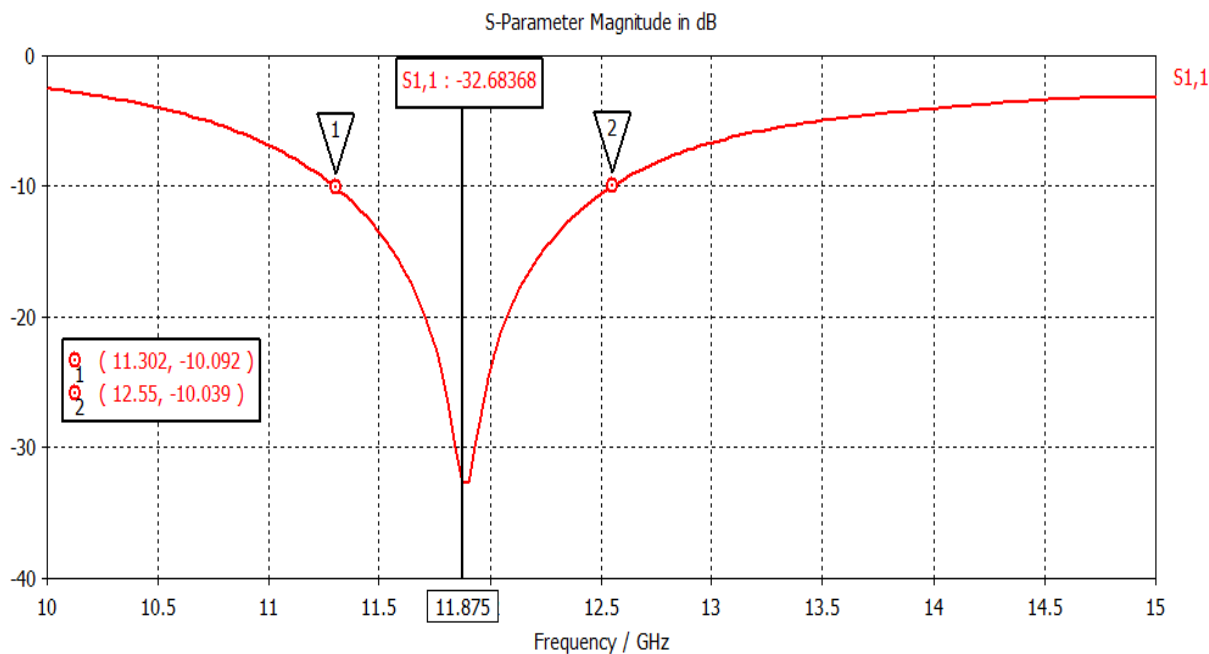
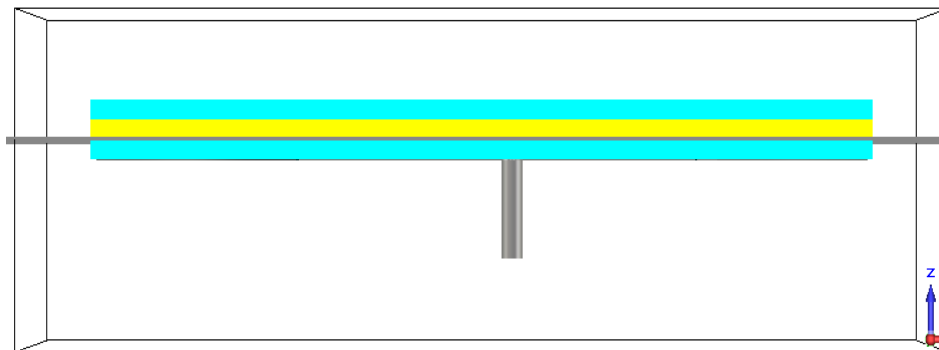

Choose $L1$ & $L2$ for 50Ω
Obtain a hexagon

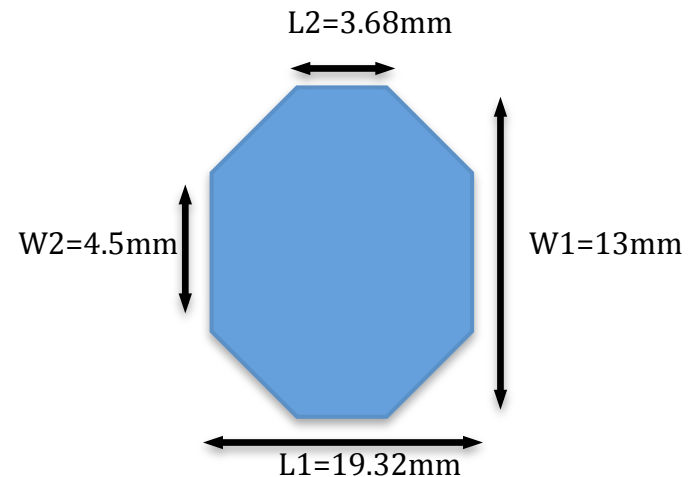

Expected
Result

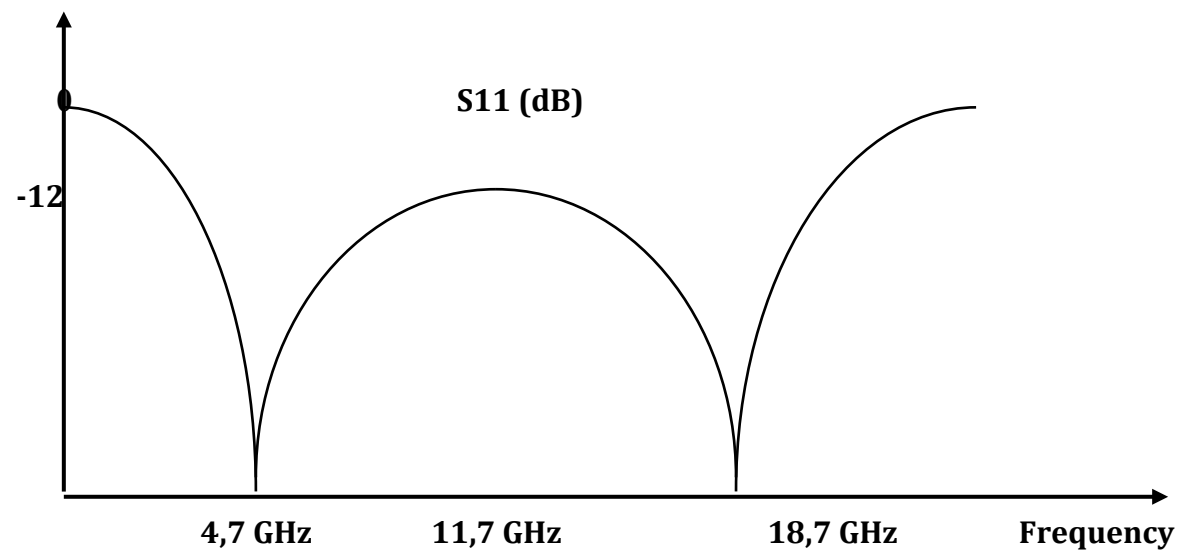

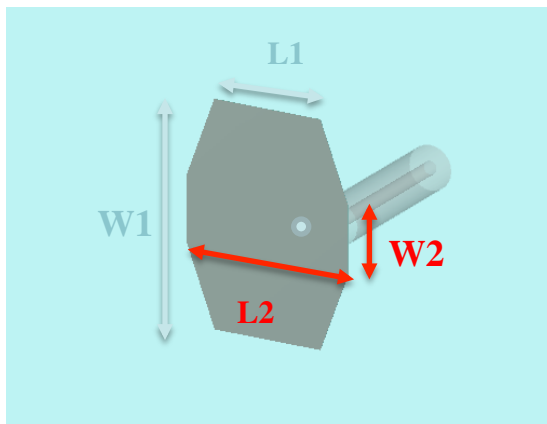

Simulation with CST program

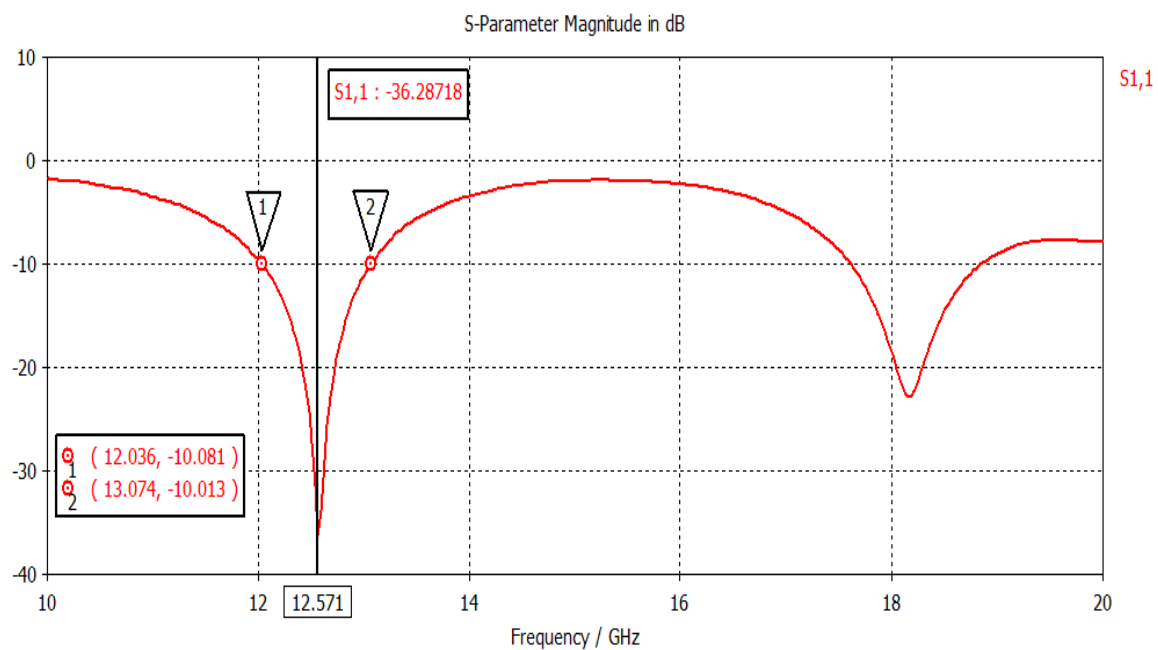

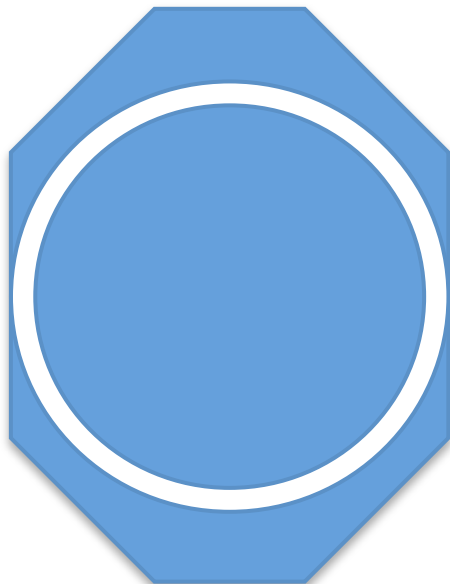

Expected
Result

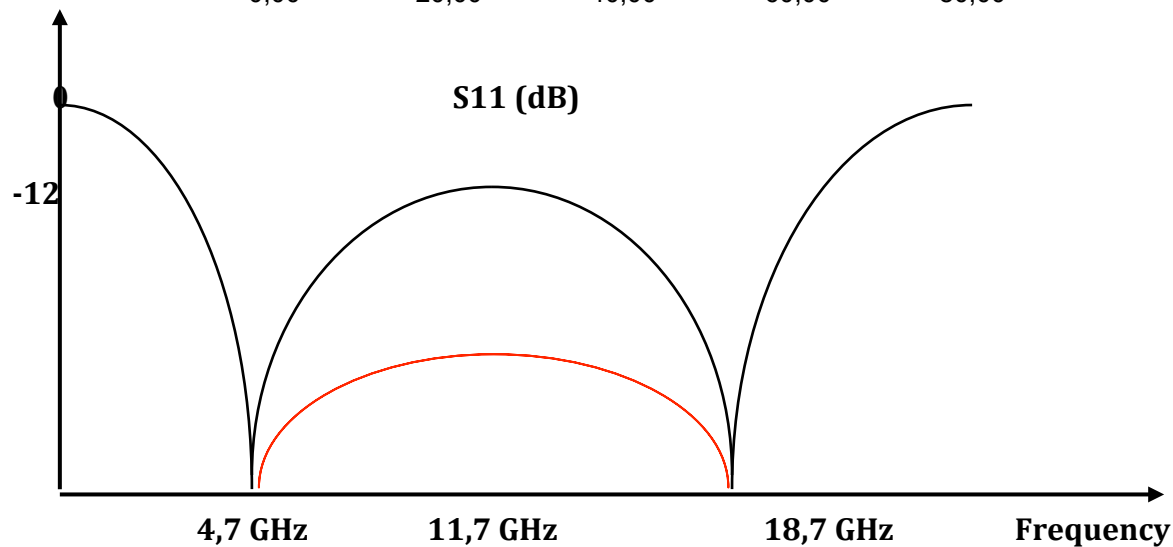
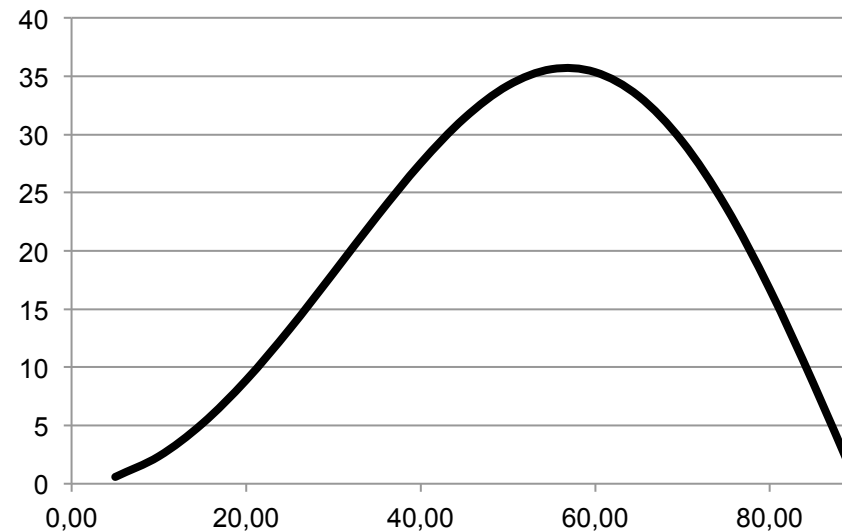

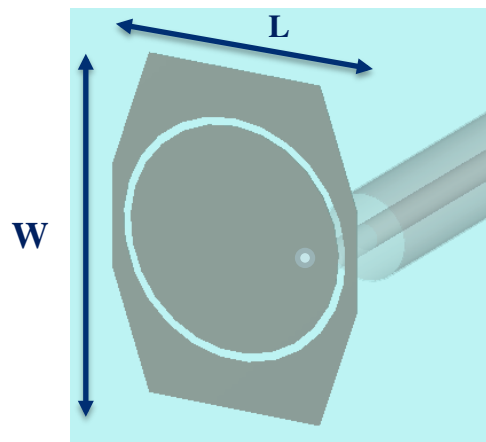

S-Parameter Magnitude in dB

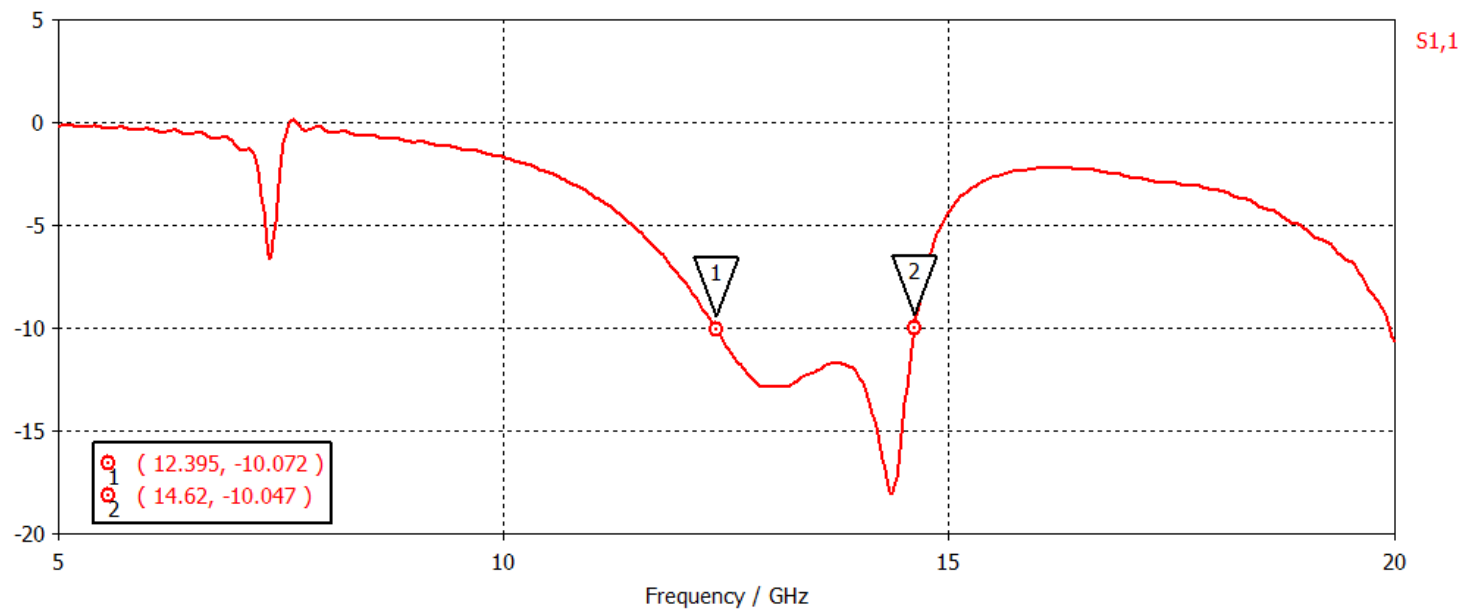

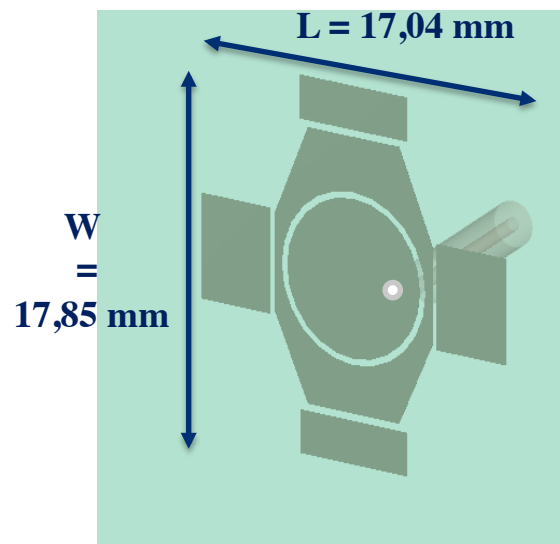

... by adding Rectangles

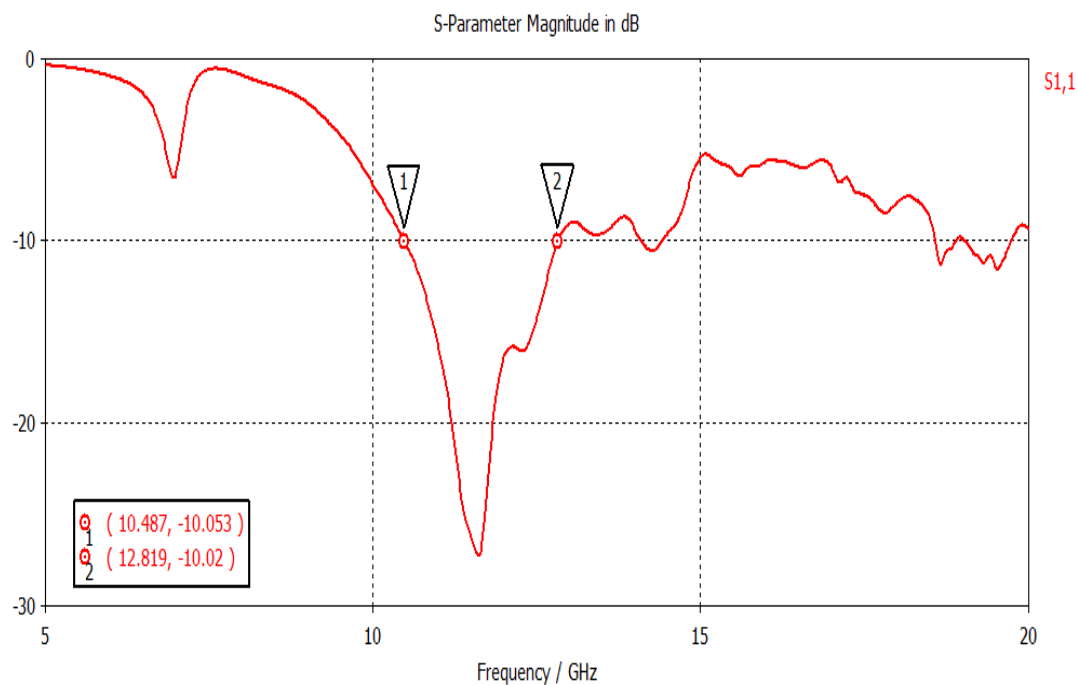

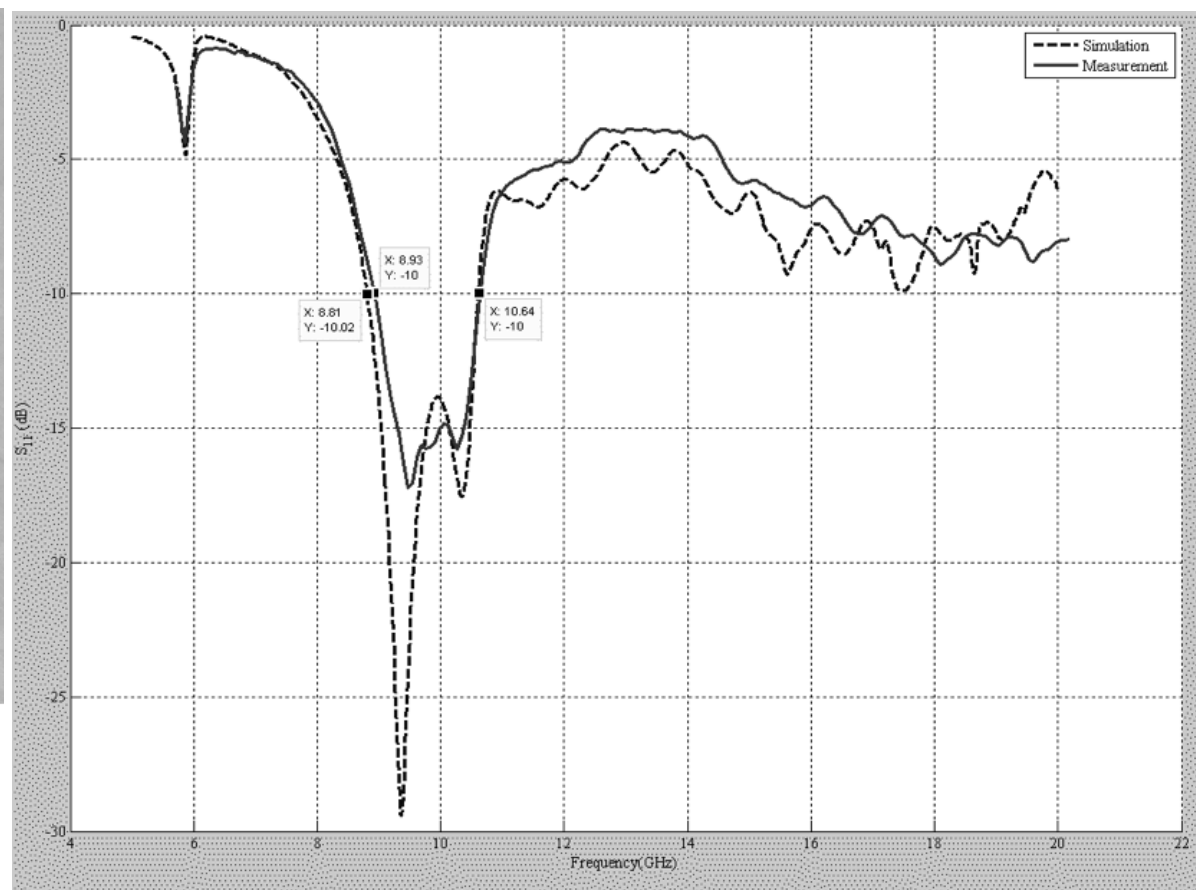
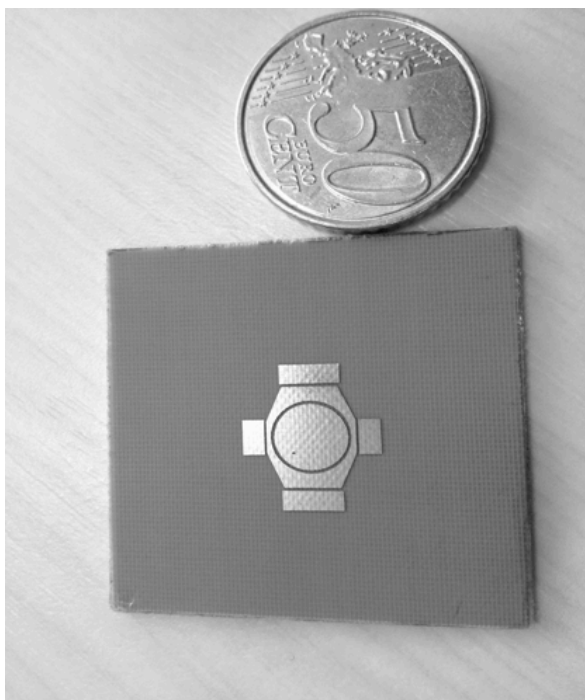

256 = 16x16 antennas are used to realize an array

Gain: 29 dBi

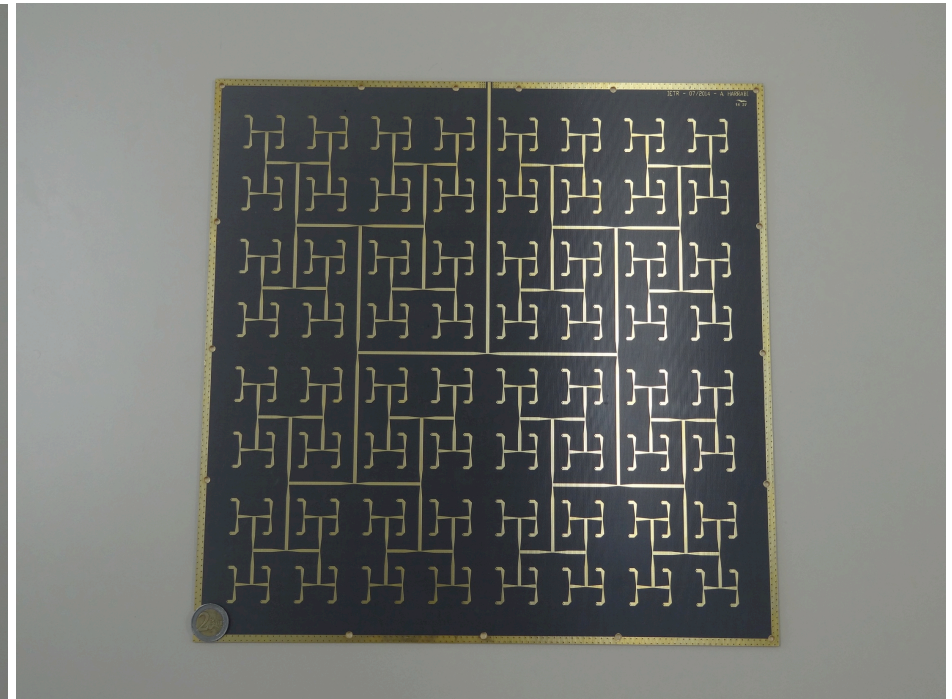
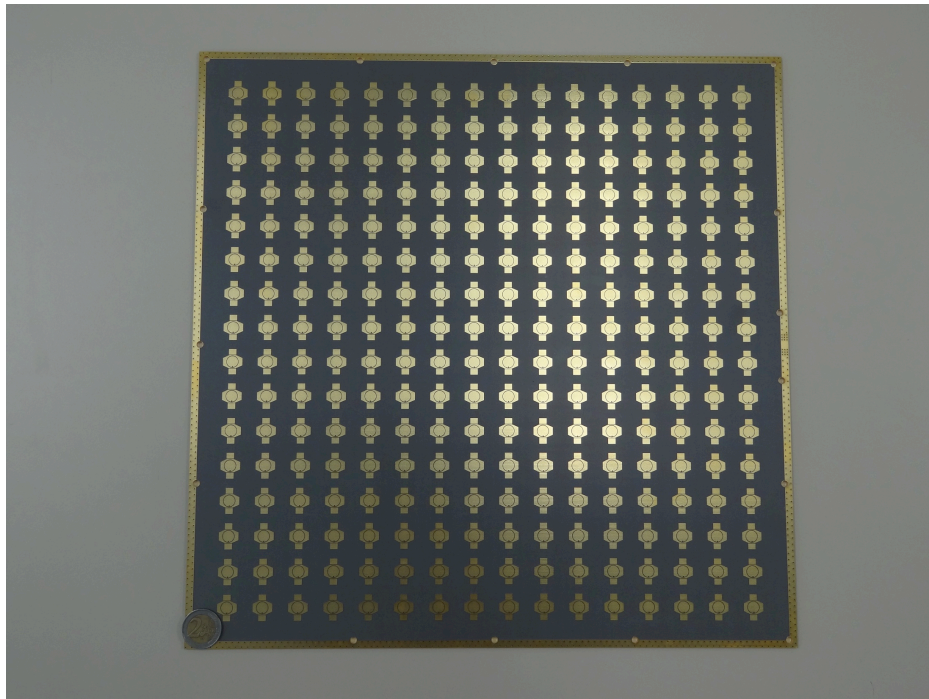

Simulated et measured radiation pattern

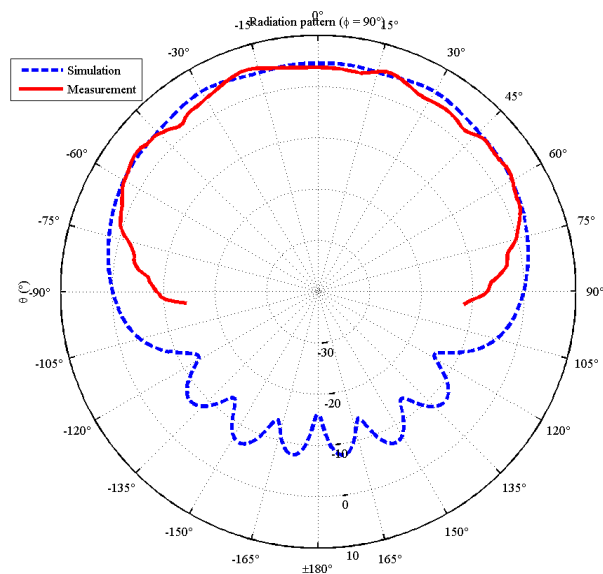

For one antenna

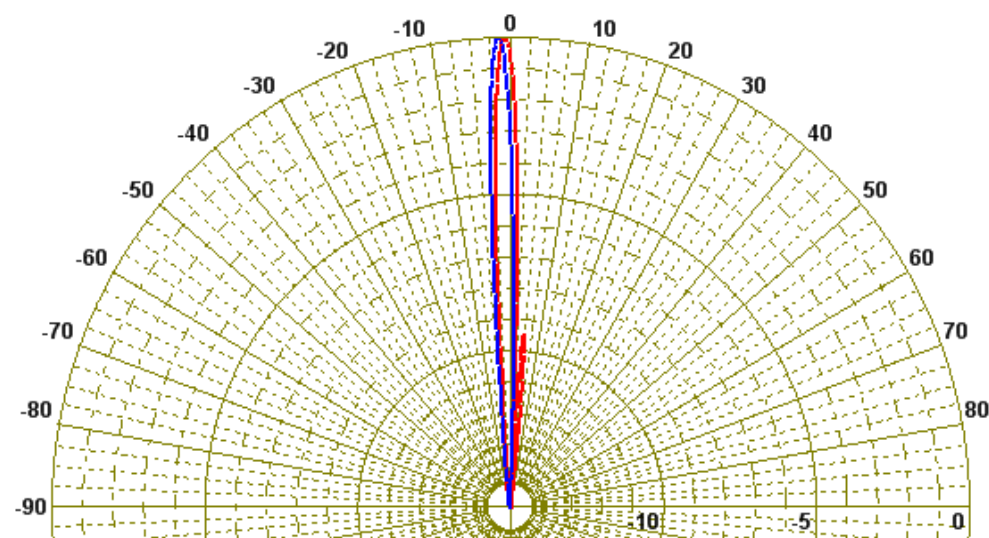

For the array (256 antennas)

Radiation control

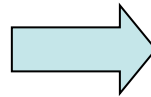

Phase shifter design

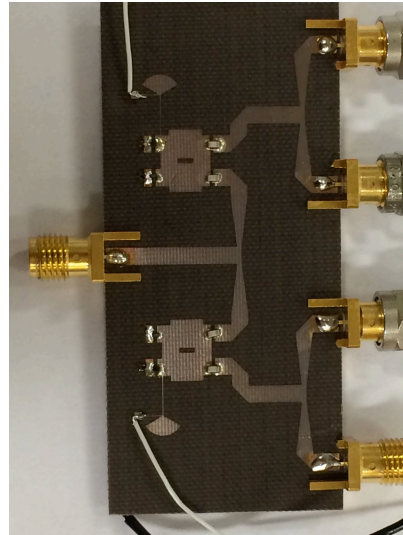
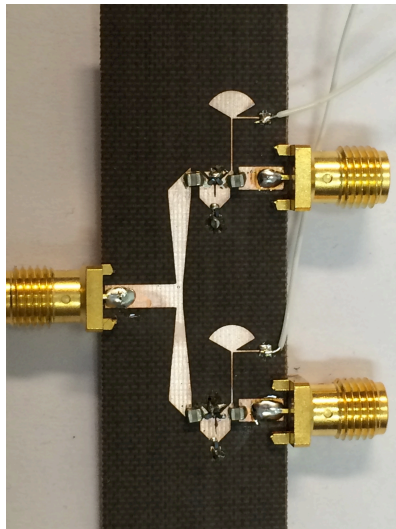

Rawia's thesis :
Phase shifters using varactors
In Ku band : 10,7-12,7 GHz

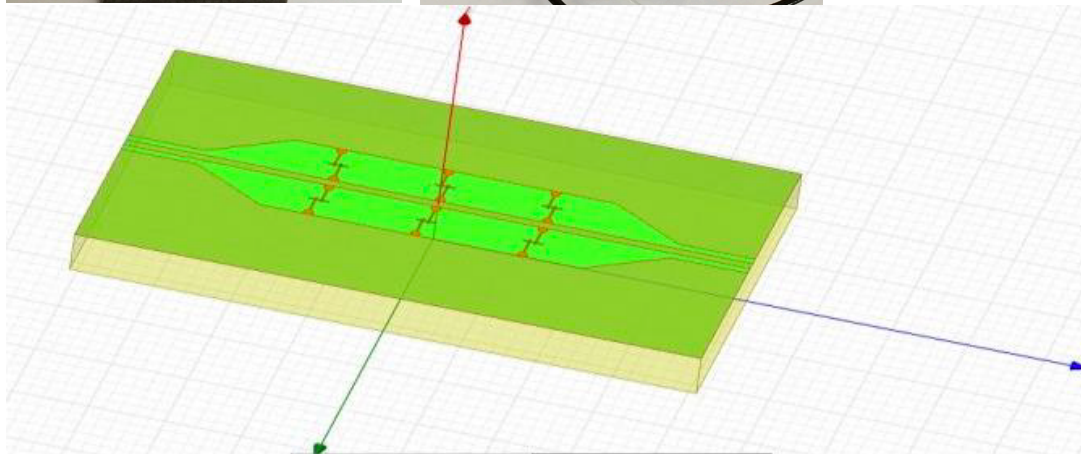

Houssam's thesis :
Phase shifter using
ferroelectric materials



3 Transparent Antenna

Flat & Discrete Antenna for Base Stations

Requirements :

-Wide band : 1.7 to 2.2 GHz

-High gain : 17 dBi

-Double polarization : Horizontal & Vertical

-Low cross polarization < -20dB

Multi-layer, Glace Substrate, Grid Metal

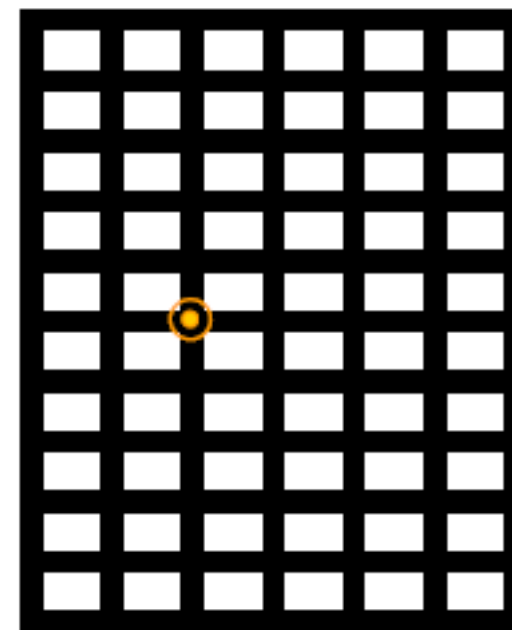
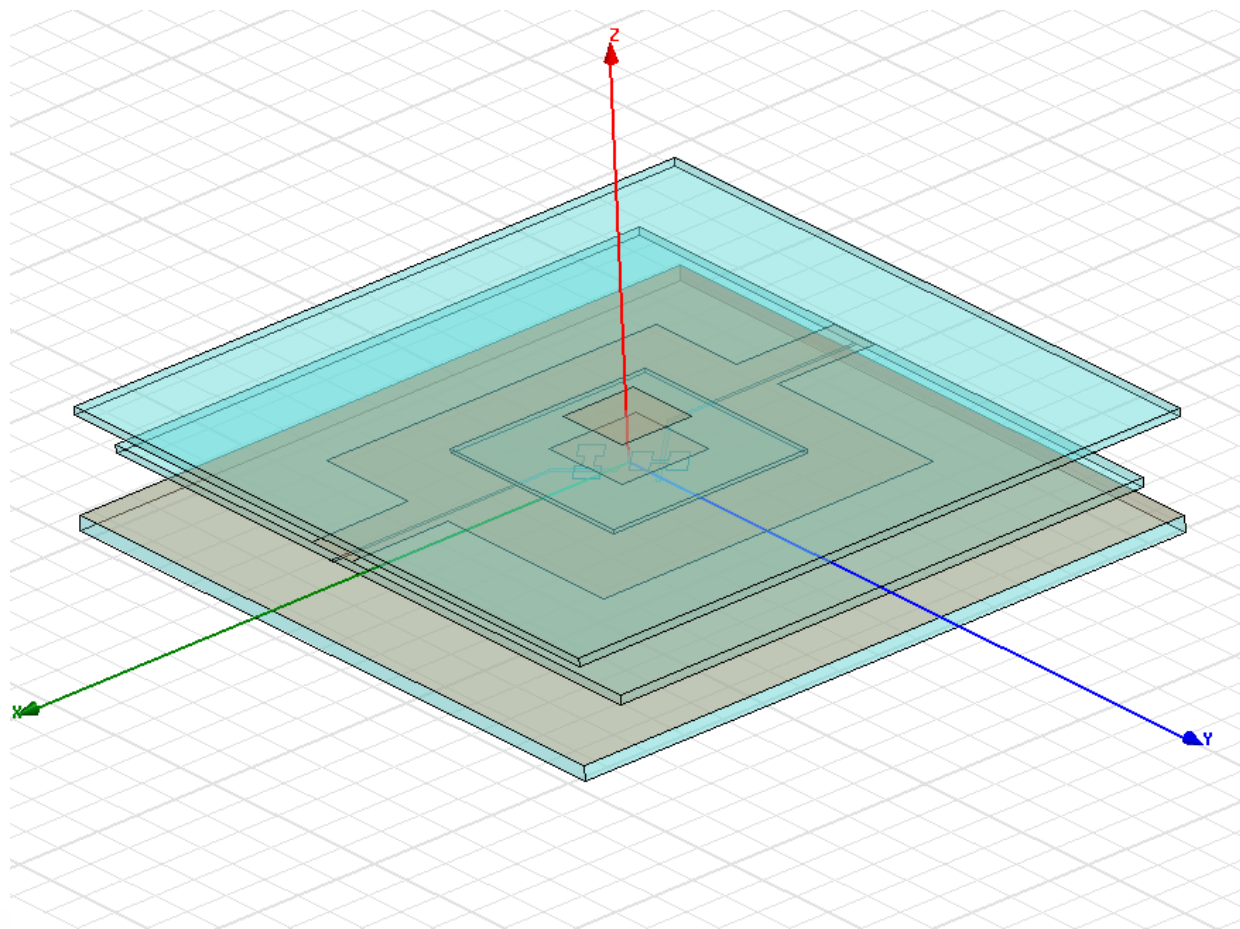

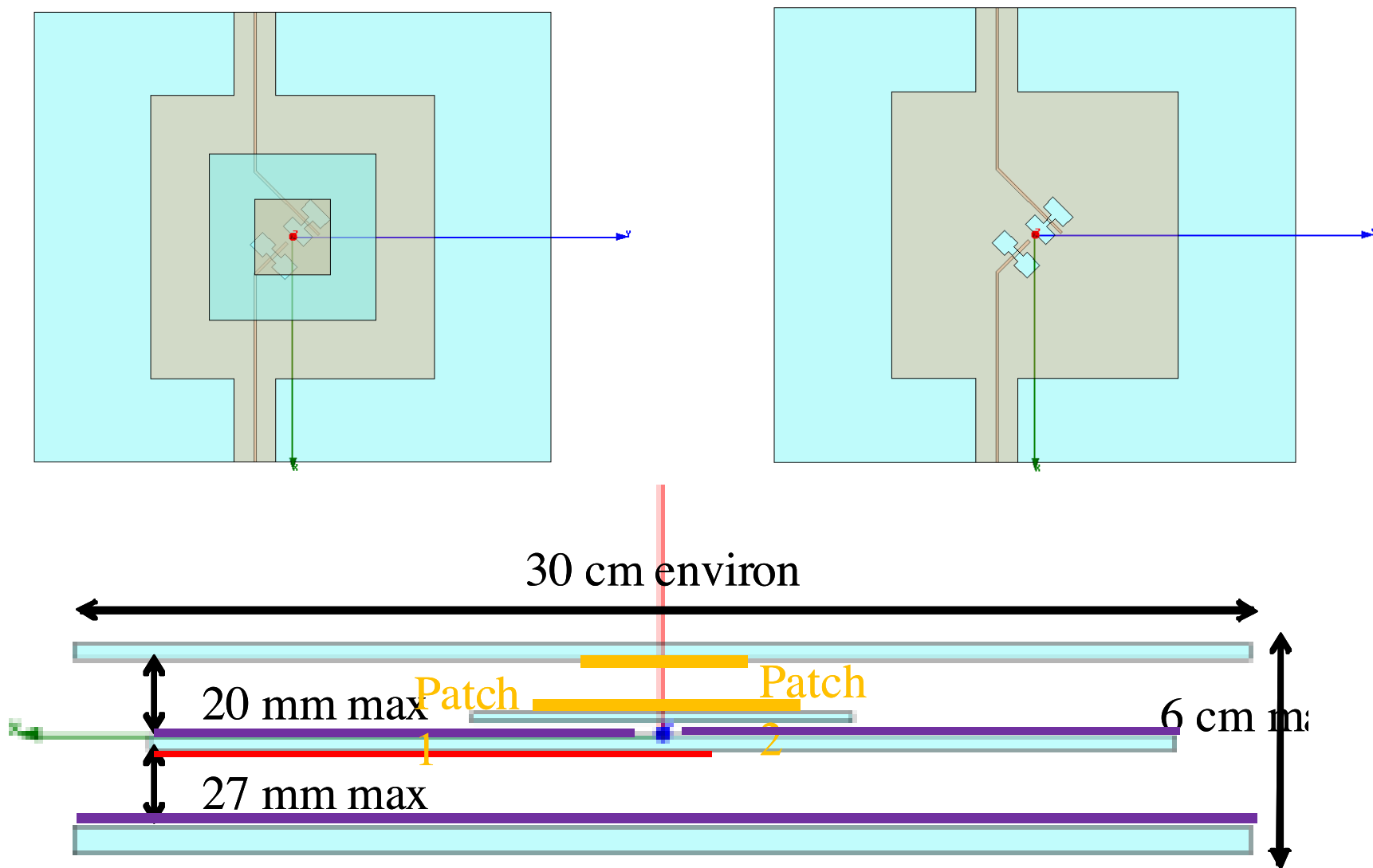

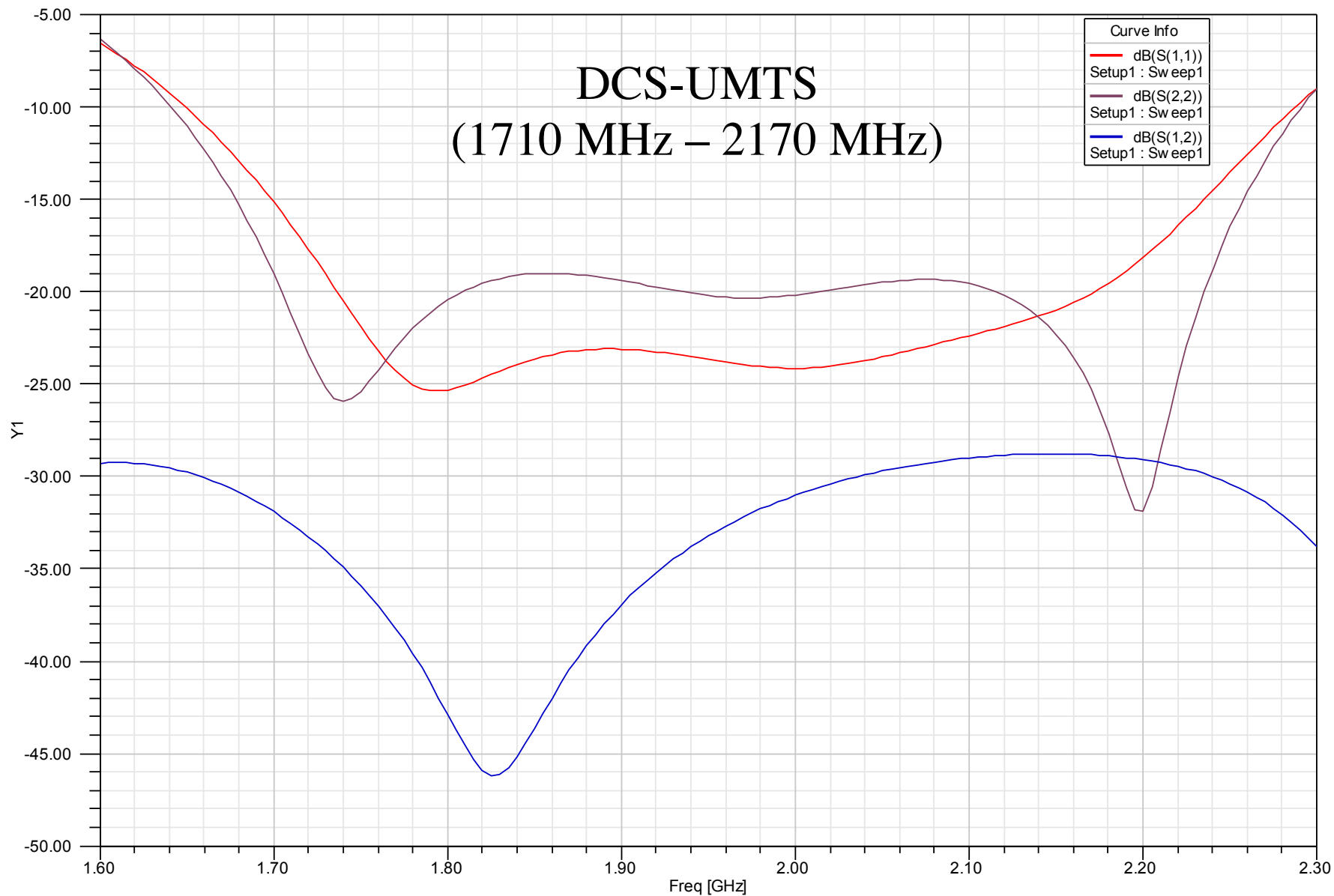

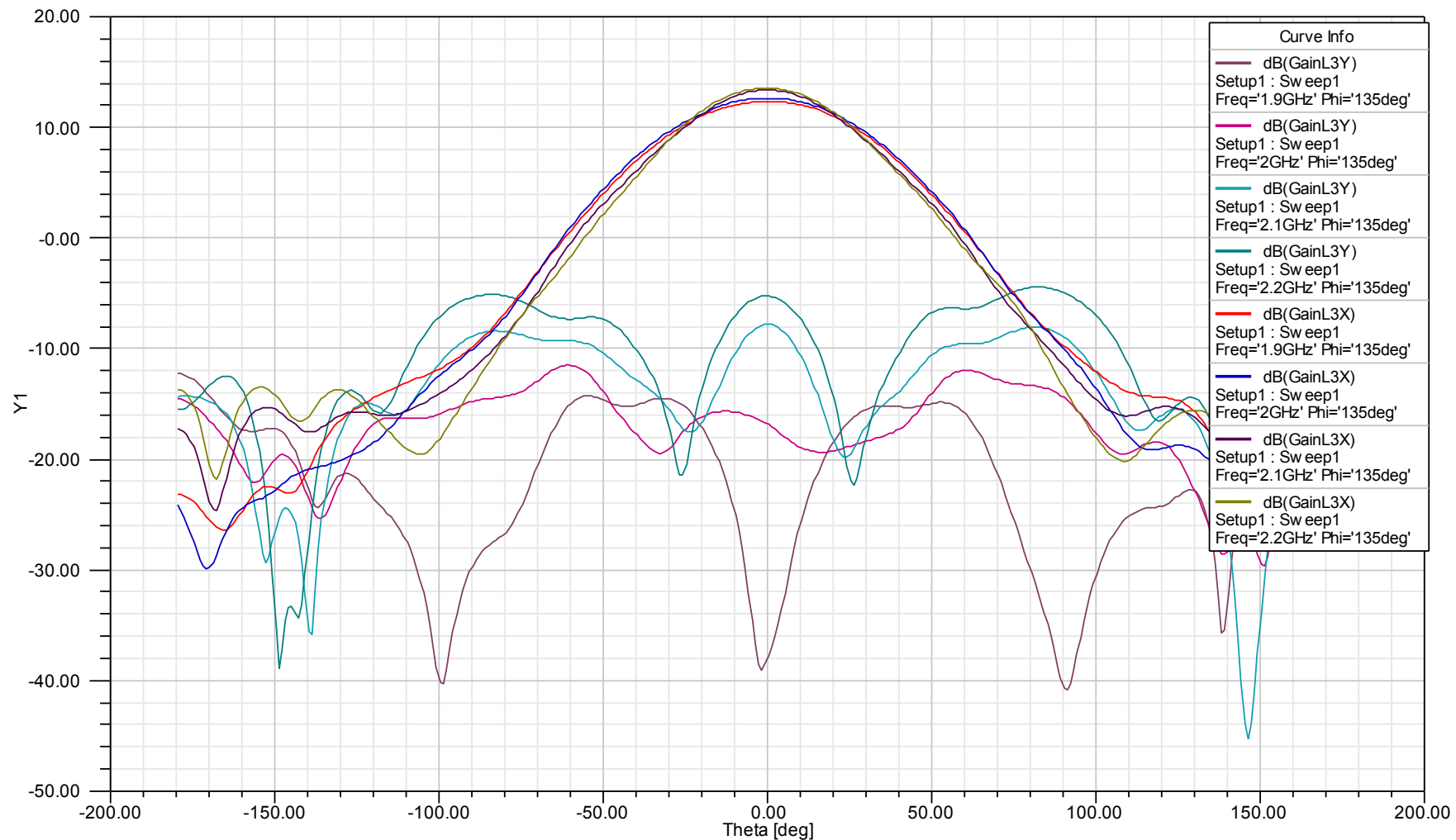

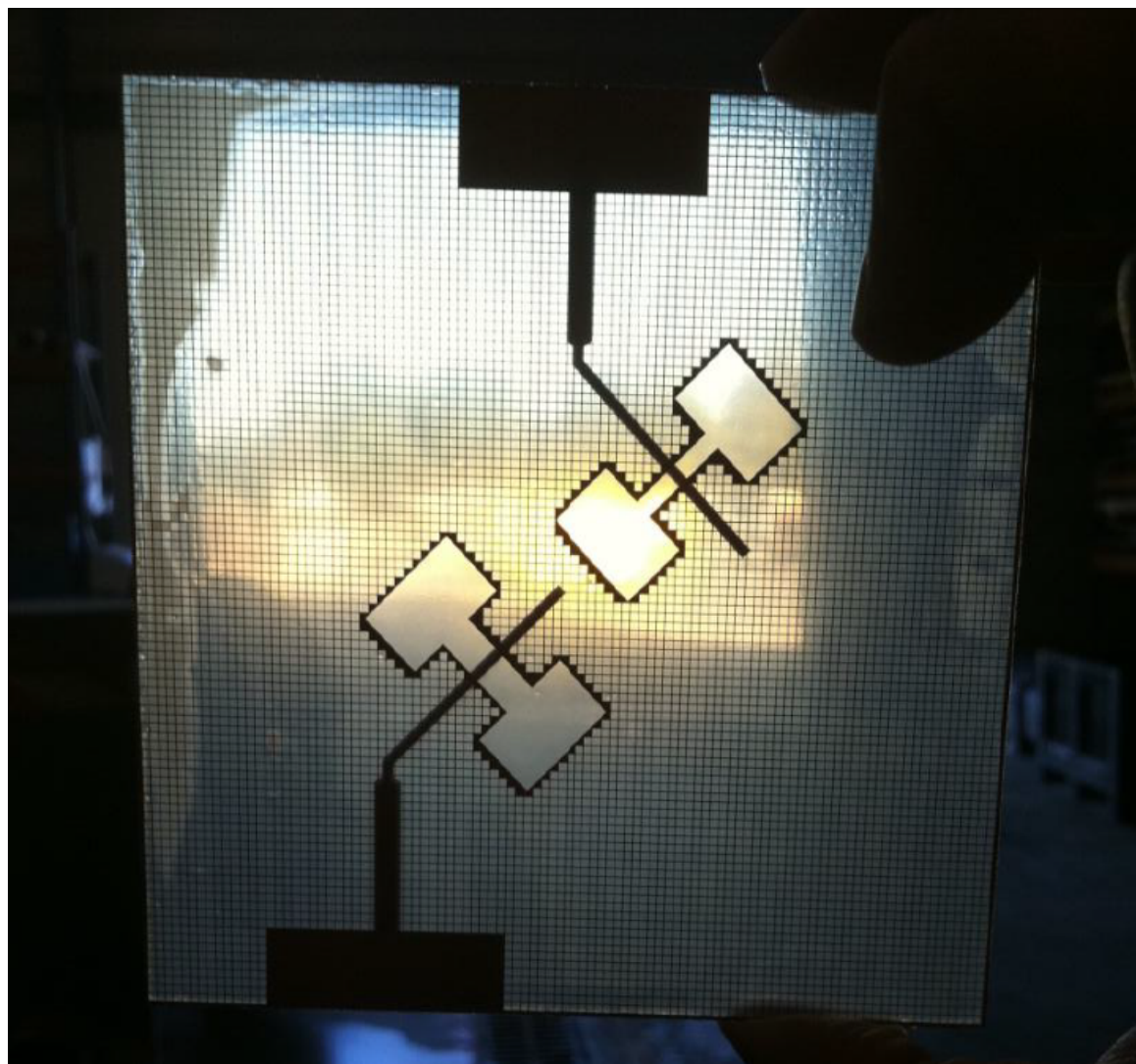

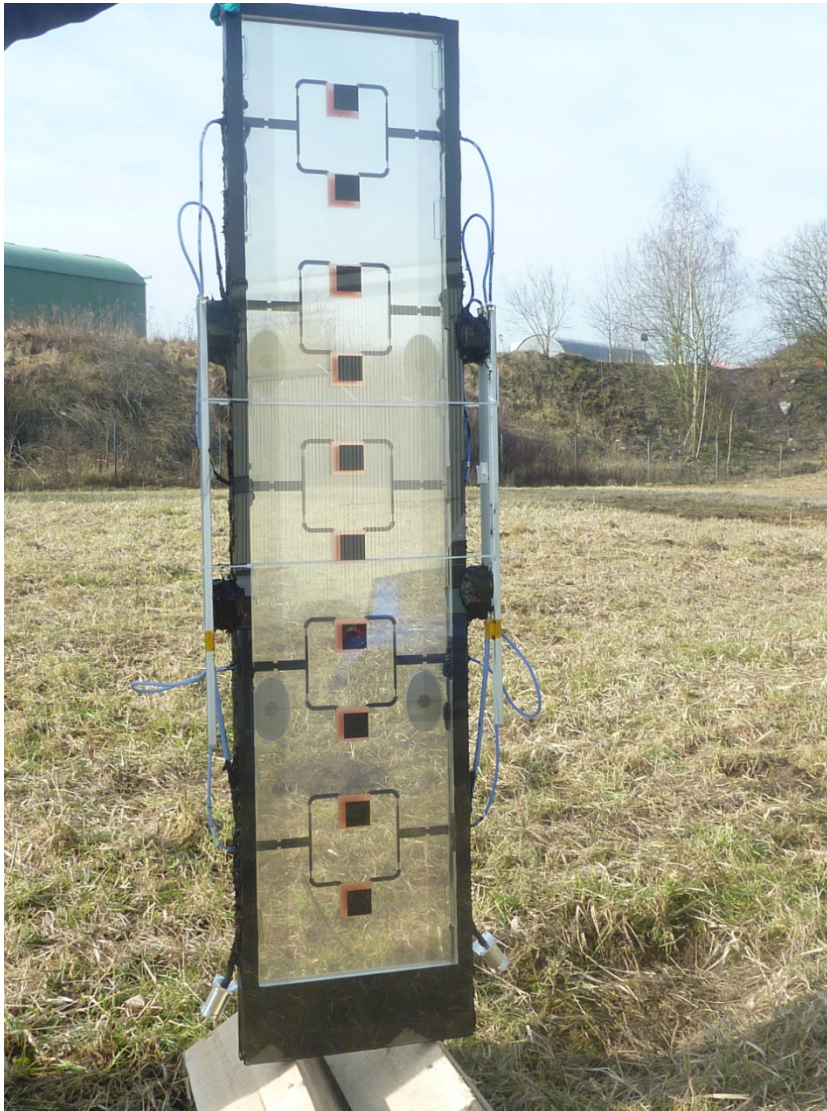

International Patent:
PCT/EP2012/076316



International Patent:
PCT/EP2012/076316

4

Reduced size Base station antenna



New antennas for 5G



Architecture

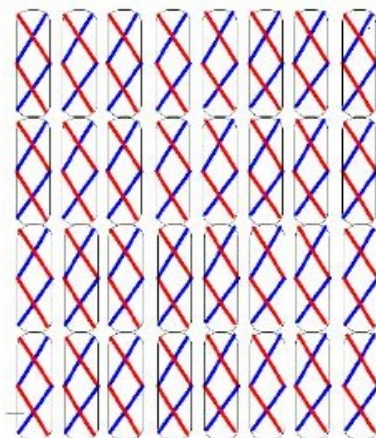

4Row x 8Column x Dual Polarization

Our objective:
Reduction of the size
of each antenna
For a compact MIMO

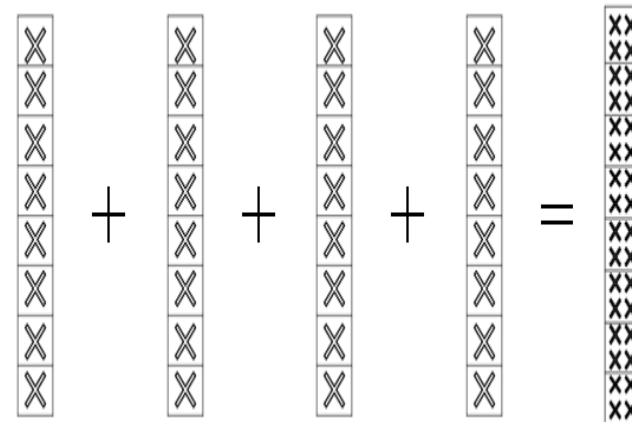

If a dipole is buried inside a dielectric:
Its length is reduced

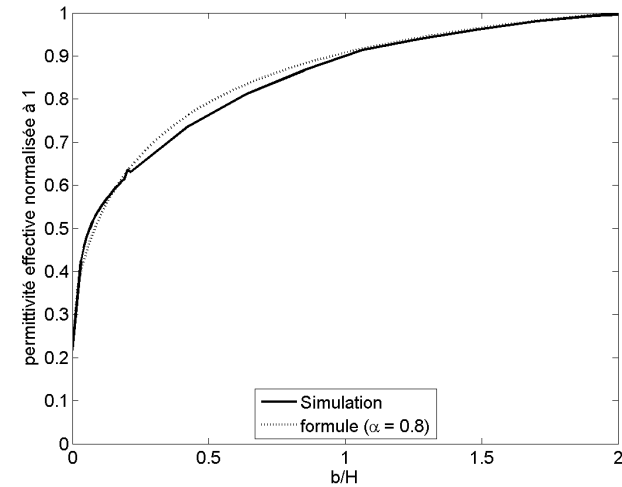
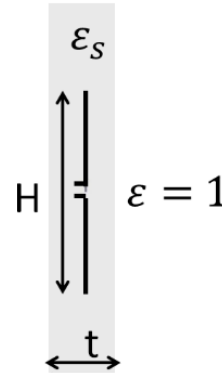

$$L = \frac{L_0}{\sqrt{\epsilon_{eff}}}$$

$$\epsilon_{eff} = 1 + \frac{\epsilon_s - 1}{\sqrt{1 + \frac{\alpha H}{t}}}$$

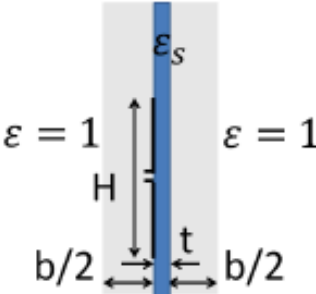
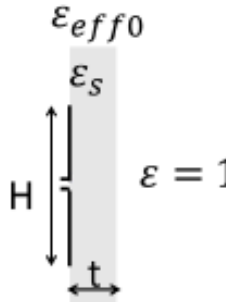
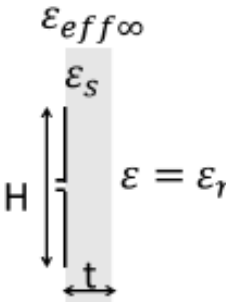
<p>hétérogène complète</p>		$\epsilon_{eff} = \epsilon_{eff0} + \frac{\epsilon_{eff\infty} - \epsilon_{eff0}}{\sqrt{1 + \frac{\alpha H}{b}}}$
<p>hétérogène initiale</p>		$\epsilon_{eff0} = 1 + \frac{\epsilon_s - 1}{\sqrt{1 + \frac{\alpha H}{t}}}$
<p>hétérogène finale</p>		$\epsilon_{eff\infty} = \epsilon_r + \frac{\epsilon_s - \epsilon_r}{\sqrt{1 + \frac{\alpha H}{t}}}$

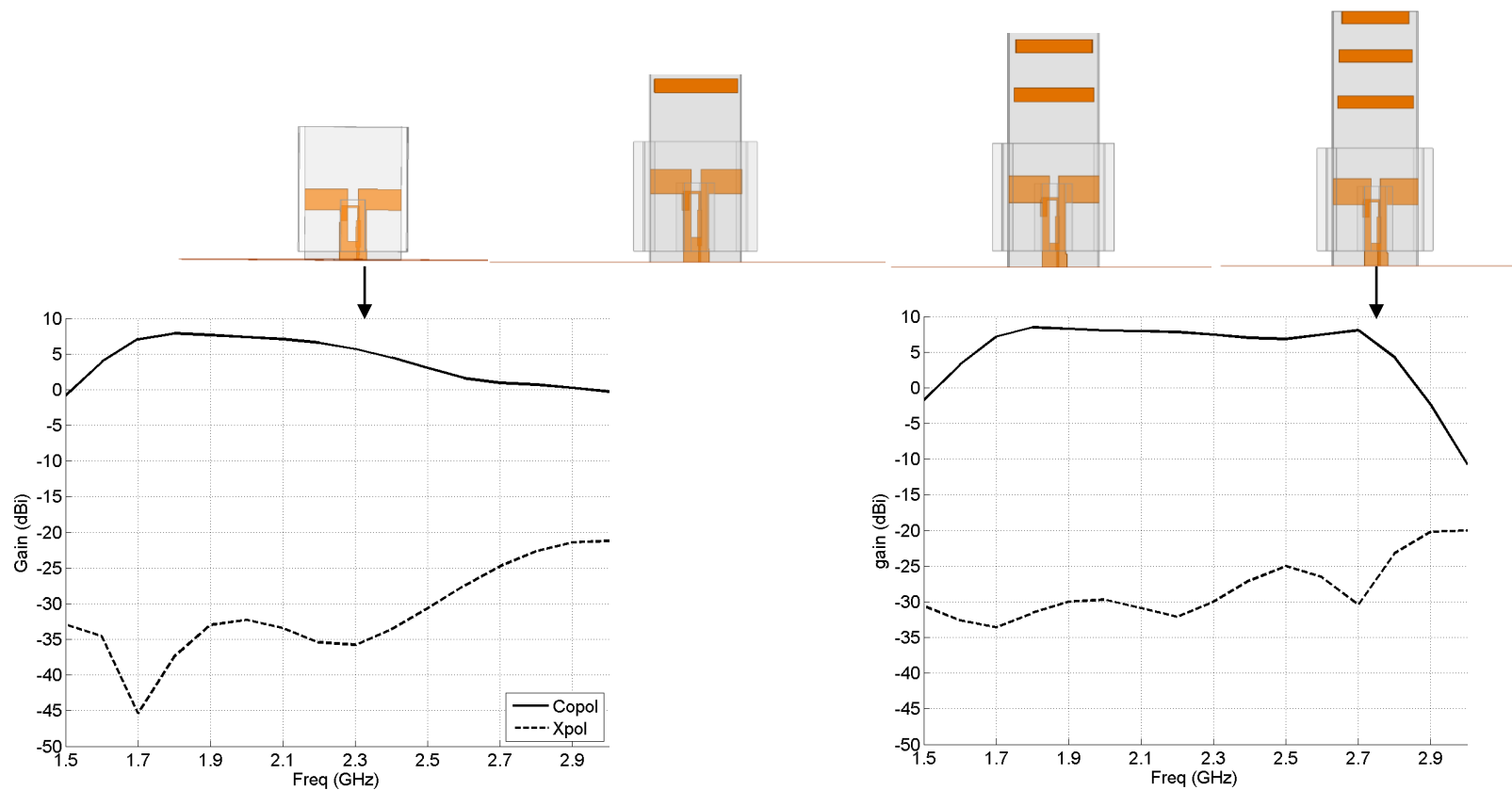

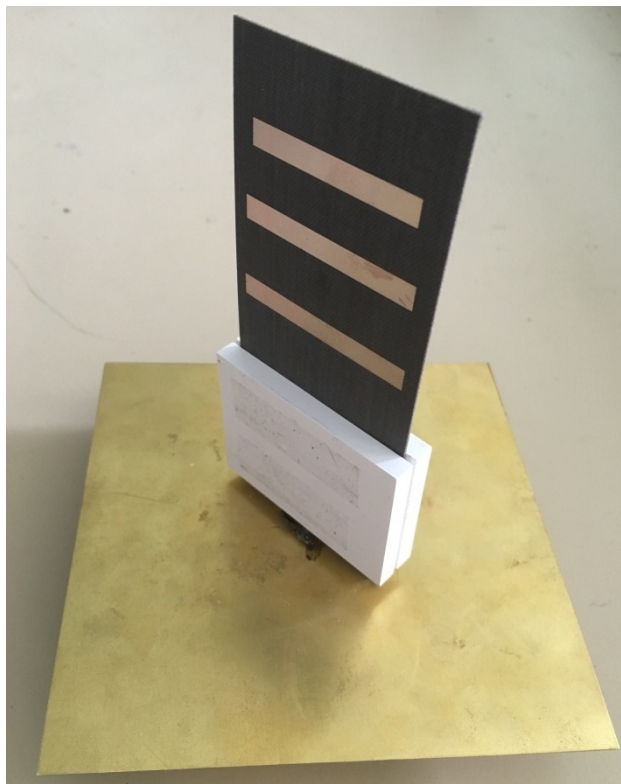

← 12 cm →

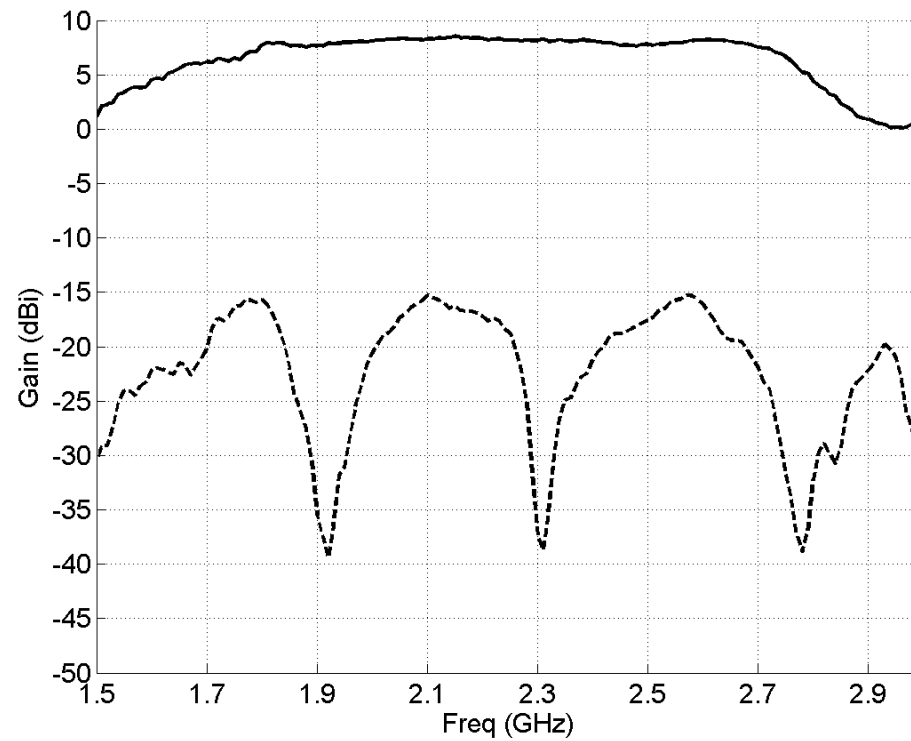

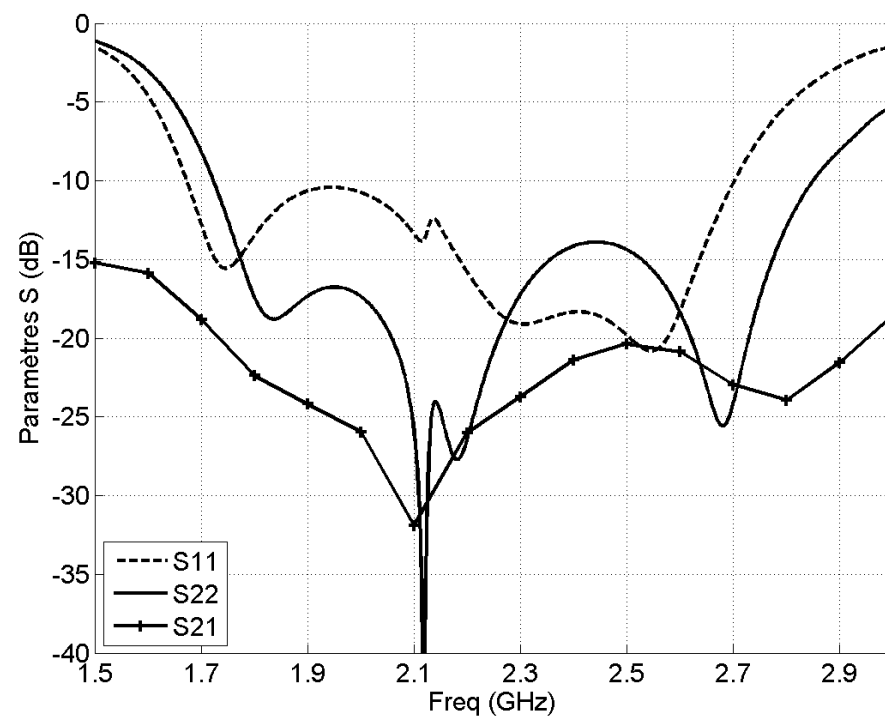
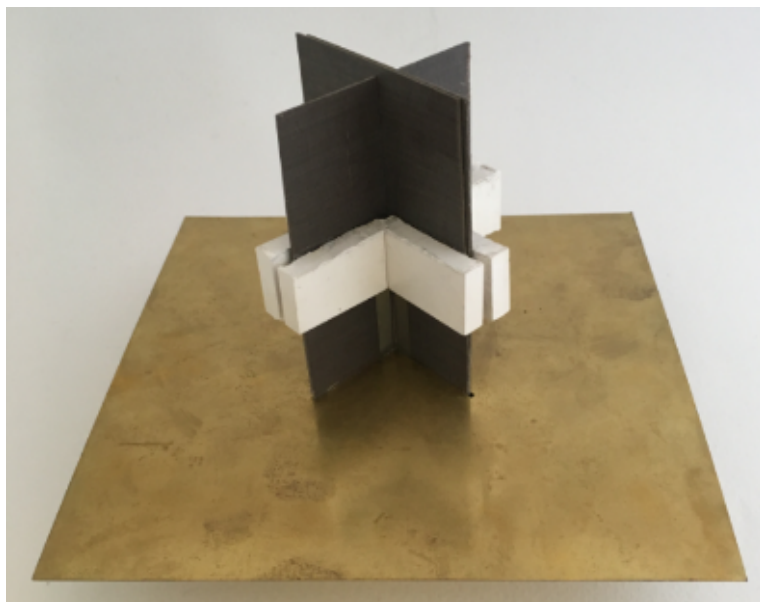

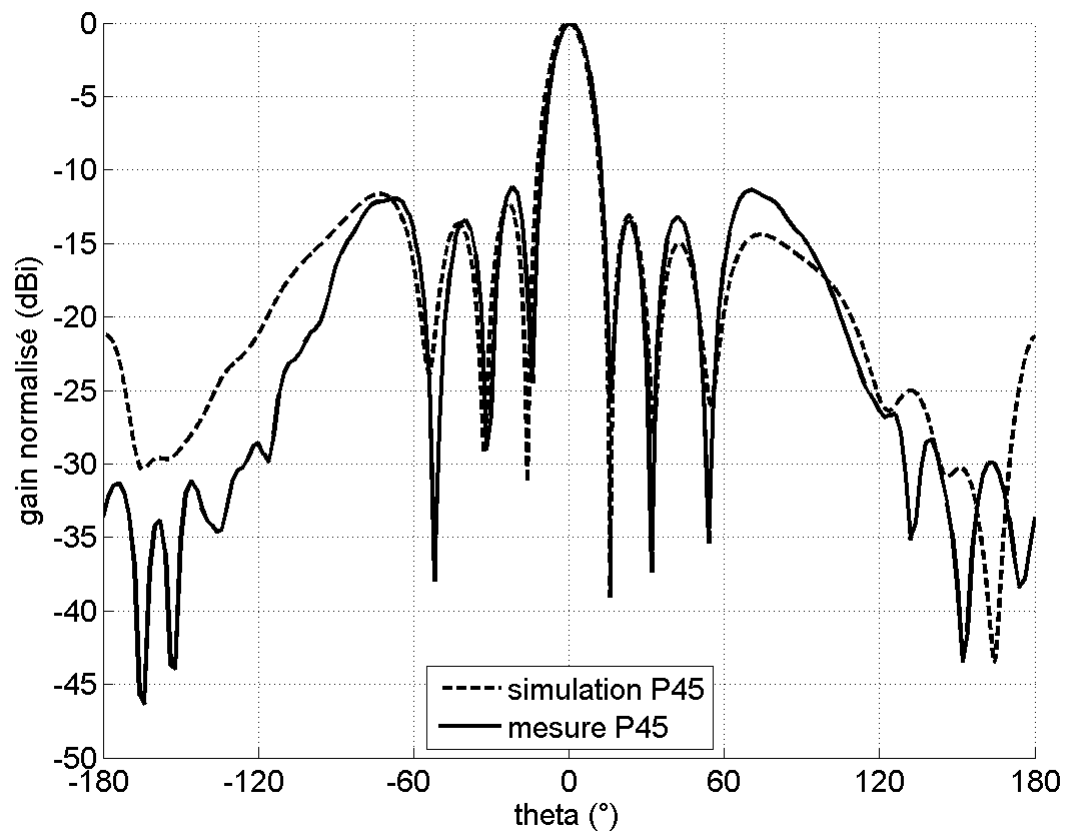
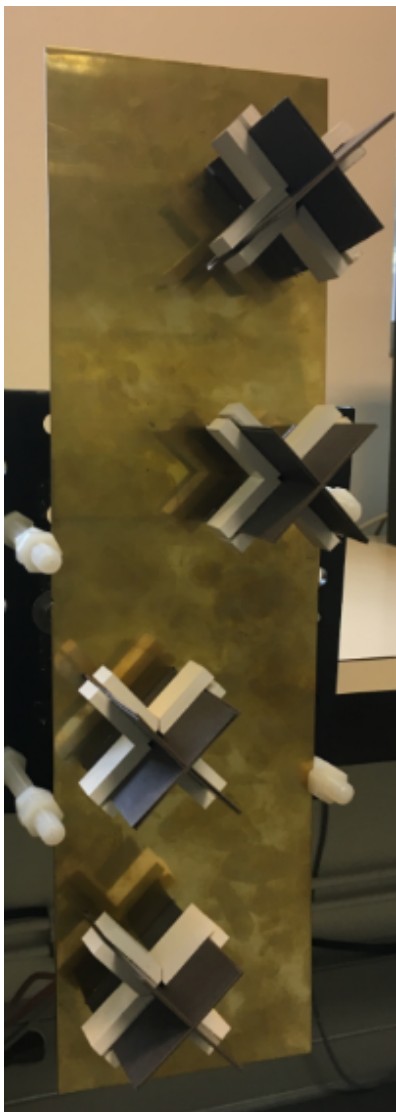

Thank You