



HAL
open science

A ZX-Calculus with Triangles for Toffoli-Hadamard, Clifford+T, and Beyond

Renaud Vilmart

► **To cite this version:**

Renaud Vilmart. A ZX-Calculus with Triangles for Toffoli-Hadamard, Clifford+T, and Beyond. QPL 2018, Jun 2018, Halifax, Canada. pp.313-344, 10.4204/EPTCS.287.18 . hal-01762264

HAL Id: hal-01762264

<https://hal.science/hal-01762264>

Submitted on 9 Apr 2018

HAL is a multi-disciplinary open access archive for the deposit and dissemination of scientific research documents, whether they are published or not. The documents may come from teaching and research institutions in France or abroad, or from public or private research centers.

L'archive ouverte pluridisciplinaire **HAL**, est destinée au dépôt et à la diffusion de documents scientifiques de niveau recherche, publiés ou non, émanant des établissements d'enseignement et de recherche français ou étrangers, des laboratoires publics ou privés.

A ZX-Calculus with Triangles for Toffoli-Hadamard, Clifford+T, and Beyond



Renaud Vilmart
renaud.vilmart@loria.fr

Université de Lorraine, CNRS, Inria, LORIA, F 54000 Nancy, France

Abstract. We consider a ZX-calculus augmented with triangle nodes which is well-suited to reason on the so-called Toffoli-Hadamard fragment of quantum mechanics. We precisely show the form of the matrices it represents, and we provide an axiomatisation which makes the language complete for the Toffoli-Hadamard quantum mechanics. We extend the language with arbitrary angles and show that any true equation involving linear diagrams which constant angles are multiple of π are derivable. We show that a single axiom is then necessary and sufficient to make the language equivalent to the ZX-calculus which is known to be complete for Clifford+T quantum mechanics. As a by-product, it leads to a new and simple complete axiomatisation for Clifford+T quantum mechanics.

1 Introduction

The ZX-Calculus is a powerful graphical language for quantum computing [8]. It has been introduced in 2008 by Coecke and Duncan [6], and has several applications in quantum information processing (e.g. MBQC [10], quantum codes [5,4,9,14]).

The language manipulates diagrams, generated by roughly three kinds of vertices: , , and ; and which represent quantum evolutions thanks to the standard interpretation. It comes with a set of allowed transformations that preserve the represented process. These rules can be implemented in the interactive proof assistant Quantomatic [18,19]. The property that they preserve the semantics is called *soundness*, and is easily verifiable. Its converse, *completeness*, is obtained when any two diagrams that represent the same process can be transformed into one-another with only the rules of the ZX-Calculus.

The first completeness result was for a restriction of the language called Clifford [2]. This result was adapted to a smaller restriction of the language, the so-called real stabilizer [11]. Problem was, these two restrictions are not universal: their diagrams cannot approximate all arbitrary evolution, and they are efficiently simulable on a classical computer. The “easiest” restriction of the language with approximate universality is the Clifford+T fragment. A first step was made when completeness was discovered for the 1-qubit operations of the restriction [3]. A complete axiomatisation for the many-qubits Clifford+T fragment was finally discovered in [15], and led to a complete axiomatisation in the general case, first in [20] where two new generators were added, and then in [16] with the original syntax.

Thanks to its proximity to quantum circuitry, one of the potential uses of the ZX-Calculus is circuit simplification. The usual ZX-Calculus [6] can be seen as a generalisation of quantum circuits built with the gate set (CNot, H, $R_Z(\alpha)$) where α may take any value in \mathbb{R} . Then, the real stabilizer ZX-Calculus corresponds to the set of gates when the angles are multiples of π , the Clifford restriction to when angles are multiples of $\frac{\pi}{2}$, and the Clifford+T restriction to when angles are multiples of $\frac{\pi}{4}$.

While the Clifford+T fragment (where $T = R_Z(\pi/4)$) of quantum mechanics is preeminent in quantum information processing, Toffoli-Hadamard quantum mechanics is also well known and widely used. The Toffoli-Hadamard quantum mechanics is the real counter-part of the Clifford+T quantum mechanics: the matrices of the Toffoli+Hadamard fragment are exactly the real matrices of the Clifford+T fragment. Toffoli-Hadamard quantum mechanics is also known to be approximately universal for quantum computing [1,24]. The Toffoli gate is a 3-qubit unitary evolution which is nothing but a controlled CNot: it maps $|x, y, z\rangle$ to $|x, y, x \wedge y \oplus z\rangle$. The Toffoli gate can be decomposed into CNot, H, and T gates [22,23] and hence can be represented in the $\frac{\pi}{4}$ -fragment of the ZX-calculus, however, as pointed out in [15,21], the Toffoli gate admits simpler representations using the triangle node:

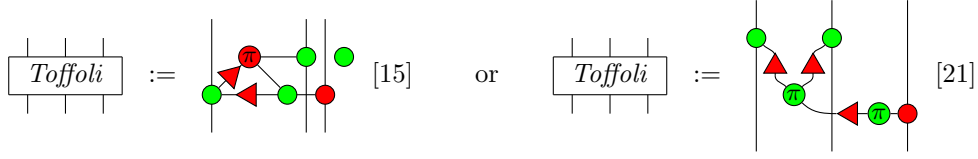

and the triangle itself can be recovered from the Toffoli gate:

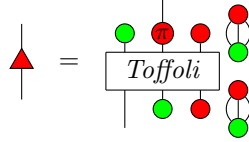

The triangle itself was introduced in [15] as a notation for a diagram of the Clifford+T restriction, and was used as one of the additional generators in [20,21]. Since the CNOT gate is depicted in ZX as the composition of two of its generators, we propose to add the triangle node as a generator for a version of the ZX-Calculus devoted to represent specifically Toffoli, without having to decompose it as a Clifford+T diagram.

We first present the diagrams of the ZX-Calculus augmented with the triangle node, and give an axiomatisation for the Toffoli-Hadamard quantum mechanics in Section 2. We prove it is universal, sound and complete in Section 3. In Section 4, we try and adapt a theorem from [16] which gives a completeness result on a broader restriction of the language. We finally give in Section 5 a simple axiomatisation for the Clifford+T fragment of the ZX-Calculus with triangles (that corresponds to the (Toffoli, H , $R_Z(\pi/4)$) gate set in circuitry), and prove it is complete.

2 Δ ZX-Calculus: A ZX-Calculus with Triangles

2.1 Diagrams and Standard Interpretation

A Δ ZX-diagram $D : k \rightarrow l$ with k inputs and l outputs is generated by:

$R_Z^{(n,m)}(\alpha) : n \rightarrow m$	$R_X^{(n,m)}(\alpha) : n \rightarrow m$	$H : 1 \rightarrow 1$
$e : 0 \rightarrow 0$	$\mathbb{I} : 1 \rightarrow 1$	$\sigma : 2 \rightarrow 2$
$\epsilon : 2 \rightarrow 0$	$\eta : 0 \rightarrow 2$	$\Delta : 1 \rightarrow 1$

where $n, m \in \mathbb{N}$ and $\alpha \in \mathbb{R}$. The generator e is the empty diagram.

and the two compositions:

- Spatial Composition: for any $D_1 : a \rightarrow b$ and $D_2 : c \rightarrow d$, $D_1 \otimes D_2 : a + c \rightarrow b + d$ consists in placing D_1 and D_2 side by side, D_2 on the right of D_1 .
- Sequential Composition: for any $D_1 : a \rightarrow b$ and $D_2 : b \rightarrow c$, $D_2 \circ D_1 : a \rightarrow c$ consists in placing D_1 on the top of D_2 , connecting the outputs of D_1 to the inputs of D_2 .

The standard interpretation of the Δ ZX-diagrams associates to any diagram $D : n \rightarrow m$ a linear map $\llbracket D \rrbracket : \mathbb{C}^{2^n} \rightarrow \mathbb{C}^{2^m}$ inductively defined as follows:

$\llbracket \cdot \rrbracket$

$$\llbracket D_1 \otimes D_2 \rrbracket := \llbracket D_1 \rrbracket \otimes \llbracket D_2 \rrbracket \quad \llbracket D_2 \circ D_1 \rrbracket := \llbracket D_2 \rrbracket \circ \llbracket D_1 \rrbracket$$

$$\llbracket \text{[dashed square]} \rrbracket := (1) \quad \llbracket \text{[vertical line]} \rrbracket := \begin{pmatrix} 1 & 0 \\ 0 & 1 \end{pmatrix} \quad \llbracket \text{[yellow square]} \rrbracket := \frac{1}{\sqrt{2}} \begin{pmatrix} 1 & 1 \\ 1 & -1 \end{pmatrix} \quad \llbracket \text{[red triangle]} \rrbracket = \begin{pmatrix} 1 & 1 \\ 0 & 1 \end{pmatrix}$$

$$\llbracket \bowtie \rrbracket := \begin{pmatrix} 1 & 0 & 0 & 0 \\ 0 & 0 & 1 & 0 \\ 0 & 1 & 0 & 0 \\ 0 & 0 & 0 & 1 \end{pmatrix} \quad \llbracket \cup \rrbracket := (1 \ 0 \ 0 \ 1) \quad \llbracket \cap \rrbracket := \begin{pmatrix} 1 \\ 0 \\ 0 \\ 1 \end{pmatrix}$$

For any $\alpha \in \mathbb{R}$, $\llbracket \odot \rrbracket := (1 + e^{i\alpha})/2^n$, and for any $n, m \geq 0$ such that $n + m > 0$:

$$\llbracket \odot \rrbracket := 2^m \begin{pmatrix} 1 & 0 & \cdots & 0 & 0 \\ 0 & 0 & \cdots & 0 & 0 \\ \vdots & \vdots & \ddots & \vdots & \vdots \\ 0 & 0 & \cdots & 0 & 0 \\ 0 & 0 & \cdots & 0 & e^{i\alpha} \end{pmatrix} \quad \llbracket \odot \rrbracket := \llbracket \square \rrbracket^{\otimes m} \circ \llbracket \odot \rrbracket \circ \llbracket \square \rrbracket^{\otimes n}$$

(where $M^{\otimes 0} = (1)$ and $M^{\otimes k} = M \otimes M^{\otimes k-1}$ for any $k \in \mathbb{N}^*$).

To simplify, the red and green nodes will be represented empty when holding a 0 angle:

$$\begin{pmatrix} \cdots \\ \circlearrowleft \\ \cdots \end{pmatrix} := \begin{pmatrix} \cdots \\ \circlearrowright \\ \cdots \end{pmatrix} \quad \text{and} \quad \begin{pmatrix} \cdots \\ \circlearrowright \\ \cdots \end{pmatrix} := \begin{pmatrix} \cdots \\ \circlearrowleft \\ \cdots \end{pmatrix}$$

2.2 Calculus

ΔZX represents the general ZX-Calculus with triangle, i.e. where the angles can take any value in \mathbb{R} . In the following, we will focus on some restrictions of the language. We call the $\frac{\pi}{q}$ -fragment of the ΔZX , the restriction of the ZX-Calculus with triangles, where all the angles are multiples of $\frac{\pi}{q}$, and we denote it $\Delta ZX_{\frac{\pi}{q}}$.

Two different diagrams may represent the same quantum evolution i.e. there exist two different diagrams D_1 and D_2 such that $\llbracket D_1 \rrbracket = \llbracket D_2 \rrbracket$. This issue is addressed by giving a set of axioms: a set of permitted local diagram transformations that preserve the semantics. We give in Figure 1 a set of axioms for the general ZX-Calculus with triangles, and we define the ΔZX_{π} as the same set of axioms where the angles are restricted to $\{0, \pi\}$.

Remark 1. In the following, we will freely use the notation $\Delta ZX_{\frac{\pi}{q}}$ to denote either the set of diagrams in the $\frac{\pi}{q}$ -fragment or the set of rules given for these specific diagrams.

This set of axioms consists of the rules for the real stabiliser ZX-Calculus given in [11], augmented with 5 rules that include the node Δ .

Additionally to these rules, the paradigm ‘‘Only Topology Matters’’ ensures we can be as lax as we want when manipulating diagrams, in the sense that what only matters is if two nodes are connected or not (and how many times). A distinction has to be made for Δ where the orientation of the node matters. For instance:

$$\begin{array}{cccccc} \text{loop} = | = \text{loop} & \text{cross} = || & \text{X} = \cap & \text{Y} = \cup & & \\ \text{green node} = \text{green node} & \text{green node} = \text{green node} & \text{green node} = \text{green node} & \text{green node} = \text{green node} & \text{red node} := \text{red node} & \end{array}$$

If we can transform a diagram D_1 into a diagram D_2 using the rules of ΔZX or the previous paradigm, we write $\Delta ZX \vdash D_1 = D_2$. We said earlier that ‘‘the rules can be locally applied’’. This means that for any three diagrams, D_1, D_2 , and D , if $\Delta ZX \vdash D_1 = D_2$, then:

- $\Delta ZX \vdash D_1 \circ D = D_2 \circ D$
- $\Delta ZX \vdash D \circ D_1 = D \circ D_2$
- $\Delta ZX \vdash D_1 \otimes D = D_2 \otimes D$
- $\Delta ZX \vdash D \otimes D_1 = D \otimes D_2$

An important property of the usual ZX-Calculus is that colour-swapping the diagrams (transforming green nodes in red nodes and vice-versa) preserves the equality. We made the triangle red,

and we can define a green triangle as $\triangle := \triangle$ so that this property is preserved.

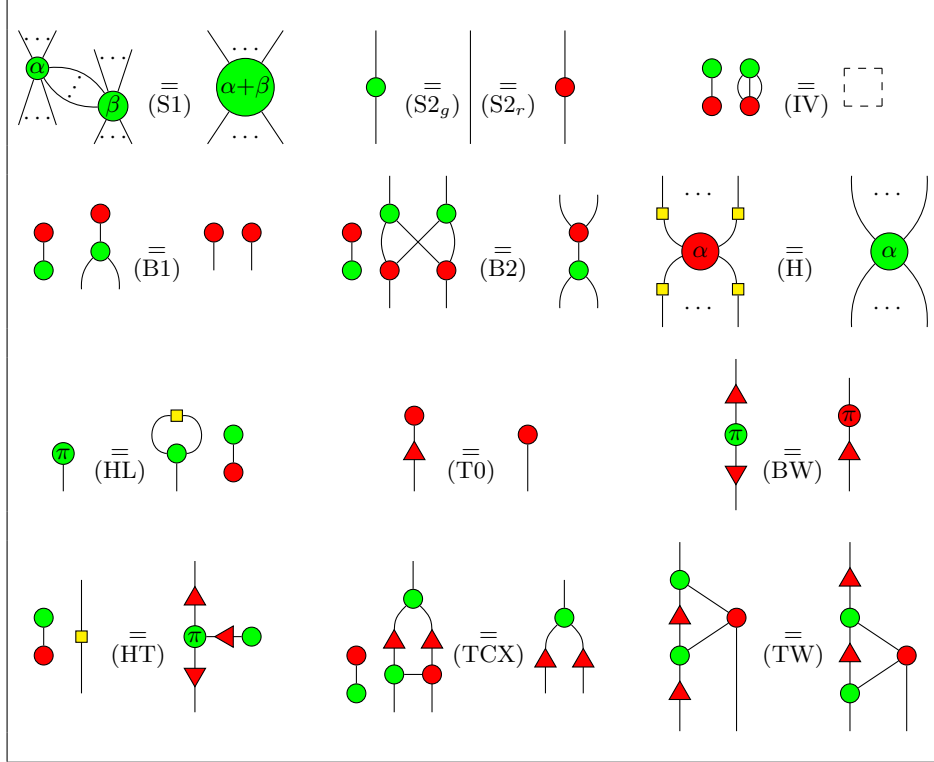

Fig. 1. Set of rules ΔZX for the ZX-Calculus with triangles. The right-hand side of (IV) is an empty diagram. (...) denote zero or more wires, while (·) denote one or more wires. $\alpha, \beta \in \mathbb{R}$. ΔZX_π is obtained when restricting the angles $\alpha, \beta \in \{0, \pi\}$.

3 Universality, Soundness, Completeness

The Toffoli+Hadamard gate set in circuitry is (approximately) universal [1,24]: any quantum evolution can be approximated with arbitrary precision by a circuit with this set of gates. It is expected that the result extends to the adequate fragment of the ΔZX -Calculus. It does:

Theorem 1. *For any matrix $M \in \frac{1}{\sqrt{2}^n} \mathcal{M}_{2^m, 2^n}(\mathbb{Z})$, there exists a ΔZX_π -diagram $D : n \rightarrow m$ such that $M = \llbracket D \rrbracket$.*

In other words, the fragment represents exactly the integer matrices of dimensions powers of two and multiplied by an arbitrary power of $\frac{1}{\sqrt{2}}$. One inclusion is easy to notice: the diagrams represent matrices in $\frac{1}{\sqrt{2}^n} \mathcal{M}_{2^m, 2^n}(\mathbb{Z})$. Indeed, the standard interpretation of all the generators is an integer matrix, multiplied by $\frac{1}{\sqrt{2}}$ in the case of the Hadamard gate, and the two compositions preserve this structure. The second inclusion, the fact that any matrix can be represented as a ΔZX_π -diagram is less trivial, and will be shown in the following.

The language is not only universal, it is *sound*: the transformations do preserve the represented quantum evolution i.e. $\Delta ZX_\pi \vdash D_1 = D_2 \implies \llbracket D_1 \rrbracket = \llbracket D_2 \rrbracket$. This is a routine check. The converse, however is harder to prove. *Completeness* is obtained when two diagrams can be transformed into one another whenever they represent the same evolution. This is our main theorem:

Theorem 2. *The set of rules in Figure 1 makes the π -fragment of the ΔZX -Calculus complete. For any diagrams D_1 and D_2 of the fragment,*

$$\llbracket D_1 \rrbracket = \llbracket D_2 \rrbracket \iff \Delta ZX_\pi \vdash D_1 = D_2$$

The proof uses the now usual method of a back and forth interpretation from the ZX-Calculus to the ZW-Calculus, another graphical language suited for quantum processes.

3.1 ZW-Calculus

The ZW-Calculus, introduced in 2010 as the GHZ/W-calculus by Coecke and Kissinger [7], was completed by Hadzihasanovic in 2015 [12]. This first complete language is only universal for matrices over \mathbb{Z} . Even though it has been extended to represent any complex matrix by the last author [13], the first version, closer to the expressive power of the π -fragment of the ΔZX -Calculus, is the one we will use in the following of the paper.

The ZW-diagrams are generated by:

$$T_e = \left\{ \begin{array}{c} \circ \\ | \end{array} \right\}, \begin{array}{c} \diagup \\ \circ \\ \diagdown \end{array}, \begin{array}{c} \bullet \\ | \end{array}, \begin{array}{c} \bullet \\ \diagup \\ \bullet \\ \diagdown \end{array}, |, \cup, \cap, \times, \times_{\bullet}, \square \end{array}$$

The generators are then composed using the two same – sequential and spatial – compositions.

Again, the diagrams represent quantum evolutions, so the language comes with a standard interpretation, inductively defined as:

$$\llbracket \cdot \rrbracket$$

$$\llbracket D_1 \otimes D_2 \rrbracket := \llbracket D_1 \rrbracket \otimes \llbracket D_2 \rrbracket \quad \llbracket D_2 \circ D_1 \rrbracket := \llbracket D_2 \rrbracket \circ \llbracket D_1 \rrbracket \quad \llbracket \square \rrbracket := (1) \quad \llbracket | \rrbracket := \begin{pmatrix} 1 & 0 \\ 0 & 1 \end{pmatrix}$$

$$\llbracket \times \rrbracket := \begin{pmatrix} 1 & 0 & 0 & 0 \\ 0 & 0 & 1 & 0 \\ 0 & 1 & 0 & 0 \\ 0 & 0 & 0 & 1 \end{pmatrix} \quad \llbracket \times_{\bullet} \rrbracket := \begin{pmatrix} 1 & 0 & 0 & 0 \\ 0 & 0 & 1 & 0 \\ 0 & 1 & 0 & 0 \\ 0 & 0 & 0 & -1 \end{pmatrix} \quad \llbracket \cap \rrbracket := \begin{pmatrix} 1 \\ 0 \\ 0 \\ 1 \end{pmatrix} \quad \llbracket \cup \rrbracket := \begin{pmatrix} 1 \\ 0 \\ 0 \\ 1 \end{pmatrix}^t$$

$$\llbracket \bullet \rrbracket := \begin{pmatrix} 0 & 1 \\ 1 & 0 \end{pmatrix} \quad \llbracket \bullet \diagup \bullet \rrbracket := \begin{pmatrix} 0 & 1 \\ 1 & 0 \\ 1 & 0 \\ 0 & 0 \end{pmatrix} \quad \llbracket \circ \rrbracket := \begin{pmatrix} 1 & 0 \\ 0 & -1 \end{pmatrix} \quad \llbracket \circ \diagup \circ \rrbracket := \begin{pmatrix} 1 & 0 & 0 & 0 \\ 0 & 0 & 0 & -1 \\ 0 & 0 & 0 & 0 \\ 0 & 0 & 0 & 0 \end{pmatrix}$$

The language also comes with its own set of axioms, given in Figure 2. Here again, the paradigm “Only Topology Matters” is respected (except for \times_{\bullet} where the ordering of inputs and outputs is not to be messed with). Using this, we define 1-legged black and white dots as 3-legged dots

with a loop: $\bullet := \begin{array}{c} \bullet \\ | \end{array}$ and $\circ := \begin{array}{c} \circ \\ | \end{array}$, and we can build any 2-legged or 3-legged white and black dots. For instance: $\begin{array}{c} \bullet \\ \cup \end{array} := \begin{array}{c} \bullet \\ | \\ \cup \end{array}$ $\begin{array}{c} \bullet \\ \cap \end{array} := \begin{array}{c} \bullet \\ | \\ \cap \end{array}$

The language is of course sound, and as previously said, complete.

3.2 $ZW_{\frac{1}{\sqrt{2}}}$ -Calculus

The π -fragment of the ΔZX -Calculus represents elements of $\frac{1}{\sqrt{2}^n} \mathcal{M}_{2^m, 2^n}(\mathbb{Z})$, while the ZW-Calculus represents elements in $\mathcal{M}_{2^m, 2^n}(\mathbb{Z})$. If the two languages had the same expressive power, it would greatly simplify the interpretation from one another, by avoiding complicated encodings such as in [15].

What is missing from the ZW-Calculus is merely a global scalar, which can be any power of $\frac{1}{\sqrt{2}}$. Intuitively, adding a generator, which only represents the scalar $\frac{1}{\sqrt{2}}$ should be enough, for tensoring it to a diagram D should yield $\frac{1}{\sqrt{2}} \llbracket D \rrbracket$, and the different powers should be obtained by putting side by side enough occurrences of the new scalar. This should deal with the expressive power of the language. It remains then to bind the new generator to the others in the axiomatisation.

Definition 1. We define the $ZW_{\frac{1}{\sqrt{2}}}$ -Calculus as the extension of the ZW-Calculus such as:

$$\left\{ \begin{array}{l} T_{\frac{1}{\sqrt{2}}} = T_e \cup \{\star\} \\ ZW_{\frac{1}{\sqrt{2}}} = ZW \cup \left\{ \star \quad \star \quad \circ \quad \stackrel{iv}{=} \quad \square \right\} \end{array} \right\}$$

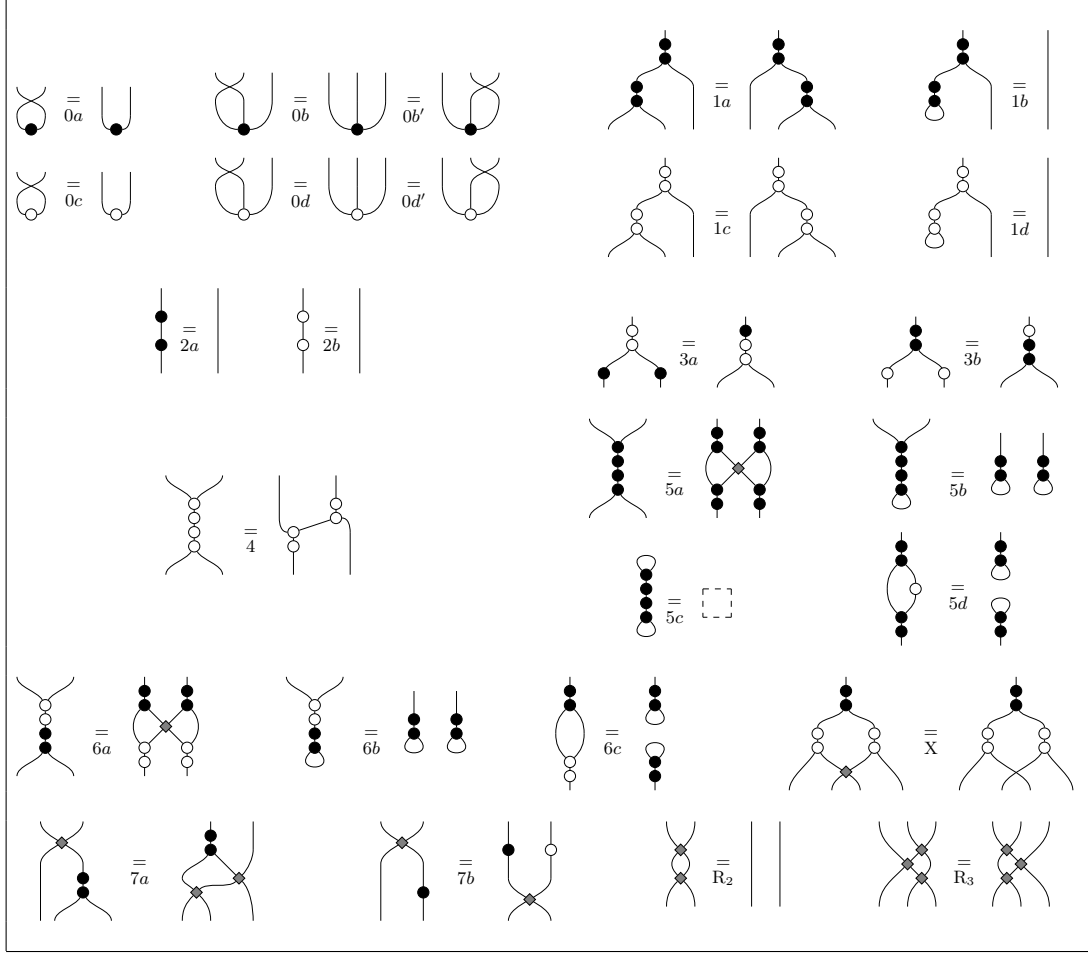

Fig. 2. Set of rules for the ZW-Calculus.

The standard interpretation of a diagram $D : n \rightarrow m$ is now a matrix $\llbracket D \rrbracket \in \frac{1}{\sqrt{2}^n} \mathcal{M}_{2^m, 2^n}(\mathbb{Z})$ that is an integer matrix times a power of $\frac{1}{\sqrt{2}}$, and is given by the standard interpretation of the ZW-Calculus extended with $\llbracket \blacklozenge \rrbracket := \frac{1}{\sqrt{2}}$.

By building on top of the already complete ZW-Calculus, some results are preserved or easily extendable. For instance, knowing that the ZW-Calculus is sound, showing that the rule *iv* is sound is enough to conclude that the $\text{ZW}_{\frac{1}{\sqrt{2}}}$ -Calculus is sound. For the completeness:

Proposition 1. *The $\text{ZW}_{\frac{1}{\sqrt{2}}}$ is sound and complete: For two diagrams D_1, D_2 of the $\text{ZW}_{\frac{1}{\sqrt{2}}}$ -calculus,*

$$\llbracket D_1 \rrbracket = \llbracket D_2 \rrbracket \iff \text{ZW}_{\frac{1}{\sqrt{2}}} \vdash D_1 = D_2$$

We now have a complete version of the ZW-Calculus, with the same – yet to be shown – expressive power as the π -fragment of the ΔZX -Calculus.

3.3 From $\text{ZW}_{\frac{1}{\sqrt{2}}}$ to ΔZX , and Expressive Power of the Letter

We define here an interpretation $[\cdot]_X$ that transforms any diagram of the $\text{ZW}_{\frac{1}{\sqrt{2}}}$ -Calculus into a ΔZX -diagram:

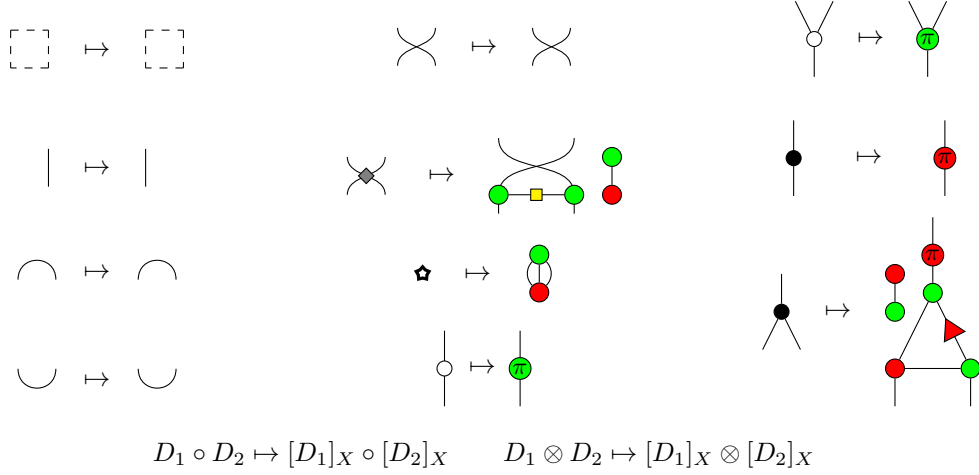

This interpretation preserves the semantics of the languages:

Proposition 2. *Let D be a $ZW_{\frac{1}{\sqrt{2}}}$ -diagram. Then $\llbracket [D]_X \rrbracket = \llbracket D \rrbracket$.*

This is a routine check. The existence of this interpretation combined with the previous proposition is enough to prove Theorem 1:

Proof (Theorem 1). Let $M \in \frac{1}{\sqrt{2}^n} \mathcal{M}_{2^m, 2^n}(\mathbb{Z})$. There exist $n \in \mathbb{N}$ and $M' \in \mathcal{M}_{2^m, 2^n}(\mathbb{Z})$ such that $M = \frac{1}{\sqrt{2}^n} M'$. M' is an integer matrix, so there exists D'_W a ZW-diagram such that $\llbracket D'_W \rrbracket = M'$. We can then build the $ZW_{\frac{1}{\sqrt{2}}}$ -diagram $D_W := D'_W \otimes (\star)^{\otimes n}$ and notice that $\llbracket D_W \rrbracket = M$. Finally, we build the ΔZX_π -diagram $D_X := [D_W]_X$ and $\llbracket D_X \rrbracket = M$ by Proposition 2. \square

Another very important result is that the ΔZX -Calculus proves the interpretation of all the rules of the $ZW_{\frac{1}{\sqrt{2}}}$ -Calculus. More specifically:

Proposition 3. *For any $ZW_{\frac{1}{\sqrt{2}}}$ -diagrams D_1 and D_2 :*

$$ZW_{\frac{1}{\sqrt{2}}} \vdash D_1 = D_2 \implies \Delta ZX \vdash [D_1]_X = [D_2]_X$$

The proof is in appendix.

3.4 From ΔZX_π to $ZW_{\frac{1}{\sqrt{2}}}$, and Completeness

We now define an interpretation from the π -fragment of the ΔZX -Calculus to the $ZW_{\frac{1}{\sqrt{2}}}$ -Calculus.

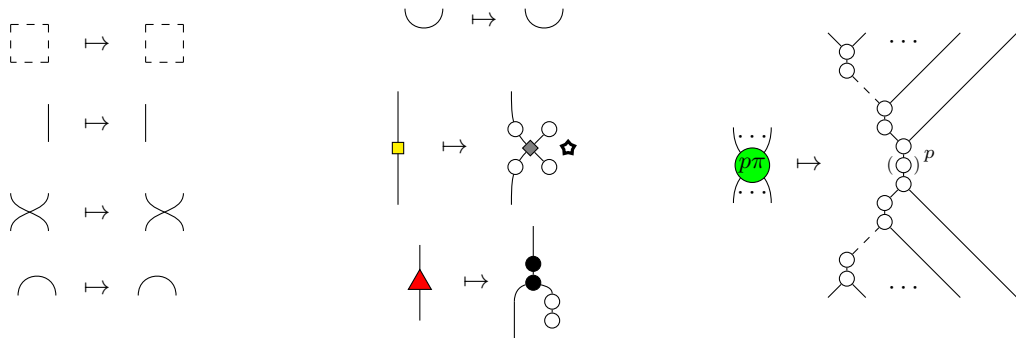

$$\forall \alpha \in \{0, \pi\}, \quad \begin{array}{c} \cdots \\ \vdots \\ \text{red dot} \\ \vdots \\ \cdots \end{array} \mapsto \left[\begin{array}{c} \vdots \\ | \\ \text{yellow square} \\ | \\ \vdots \end{array} \right]_W^{\otimes m} \circ \left[\begin{array}{c} \cdots \\ \vdots \\ \text{green dot} \\ \vdots \\ \cdots \end{array} \right]_W \circ \left[\begin{array}{c} \vdots \\ | \\ \text{yellow square} \\ | \\ \vdots \end{array} \right]_W^{\otimes n}$$

$$D_1 \circ D_2 \mapsto [D_1]_W \circ [D_2]_W \quad D_1 \otimes D_2 \mapsto [D_1]_W \otimes [D_2]_W$$

Here, $(\text{dot})^p$ either represents the identity if $p = 0$, or the $1 \rightarrow 1$ white dot if $p = 1$. The complexity of the interpretation of the green dot (and subsequently of the red dot), is merely due to the fact that we chose to present the *expanded* version of the ZW-Calculus [12], where spiders are “exploded” as compositions of 2- and 3-legged dots.

Again, the interpretation preserves the semantics:

Proposition 4. *Let D be a ΔZX_π -diagram. Then $\llbracket [D]_W \rrbracket = \llbracket D \rrbracket$.*

And again, this is a routine check. Now, when composing the two interpretation, we can easily retrieve the initial diagram:

Proposition 5. *For any diagram D of the π -fragment of the ΔZX -Calculus, $\Delta ZX_\pi \vdash \llbracket [D]_W \rrbracket_X = D$.*

We can now prove the completeness theorem:

Proof (Theorem 2). Let D_1 and D_2 be two diagrams of the ΔZX_π such that $\llbracket [D_1] \rrbracket = \llbracket [D_2] \rrbracket$. By Proposition 4, $\llbracket [D_1]_W \rrbracket = \llbracket [D_2]_W \rrbracket$. By completeness of the $ZW_{\frac{1}{\sqrt{2}}}$ (Proposition 1), $ZW_{\frac{1}{\sqrt{2}}} \vdash [D_1]_W = [D_2]_W$. By Proposition 3, $\Delta ZX_\pi \vdash \llbracket [D_1]_W \rrbracket_X = \llbracket [D_2]_W \rrbracket_X$. Finally, by Proposition 5, $\Delta ZX_\pi \vdash D_1 = D_2$, hence proving the completeness of the ΔZX_π -fragment. \square

4 Beyond Toffoli+Hadamard

The set of axioms in Figure 1 features two rules (S1) and (H), with parameters. In ΔZX_π , they are limited to $\{0, \pi\}$, but not in ΔZX . We want to know what we can prove without the limitation to $\alpha, \beta \in \{0, \pi\}$ in the set of rules. To do so, we are going to adapt a result that was developed in [16], and see what is missing to prove equalities that are valid for *linear diagrams* with constants in $\{0, \pi\}$. The following of the section will give a sketch of the proof but will not dive into its details. For more, see [16].

We call a *linear diagram*, a diagram where some angles are treated as variables, and where the parameters of the green and red dots are affine combinations of the variables, where coefficients are in \mathbb{Z} :

Definition 2. *A ΔZX -diagram is linear in $\alpha_1, \dots, \alpha_k$ with constants in $C \subseteq \mathbb{R}$, if it is generated by $R_Z^{(n,m)}(E)$, $R_X^{(n,m)}(E)$, H , Δ , e , \mathbb{I} , σ , ϵ , η , and the spatial and sequential compositions, where $n, m \in \mathbb{N}$, and E is of the form $\sum_i n_i \alpha_i + c$, with $n_i \in \mathbb{Z}$ and $c \in C$.*

For instance:

is a well-formed equation on linear diagrams, with constants in $\{0, \pi\}$. It is even sound, for it is sound for any values of α and β .

The idea of the proof is to separate the different occurrences of the variables from the rest of the diagram using the rule (S1), change their colour if they are in red nodes using (H), and change the sign in front of the variables if needs be using the equation:

Then, the scalars with $-\alpha$ can be removed in favour of scalars with α on the other side of the equation, for, thanks to (IV) and Lemma 8: $\Delta ZX \vdash \begin{array}{c} \bullet \\ \circlearrowleft \\ \bullet \end{array} D_1 = D_2 \iff ZX \vdash D_1 = \begin{array}{c} \bullet \\ \circlearrowright \\ \bullet \end{array} D_2$.

First considering the case of a unique variable, it results that for any pair of diagrams $D_1(\alpha)$ and $D_2(\alpha)$ with variable α , there exists a pair of variable-free diagrams D'_1 and D'_2 such that:

$$\begin{array}{|c|} \dots \\ \hline D_1(\alpha) \\ \hline \dots \end{array} = \begin{array}{|c|} \dots \\ \hline D_2(\alpha) \\ \hline \dots \end{array} \iff \begin{array}{|c|} \dots \\ \hline D'_1 \\ \hline \dots \end{array} = \begin{array}{|c|} \dots \\ \hline D'_2 \\ \hline \dots \end{array}$$

We then have to find a diagram that is precisely a projector onto the span of $\left(\begin{array}{c} \bullet \\ \circlearrowright \end{array}\right)^{\otimes r}$. We give the family (P_r) of diagrams, inductively defined as:

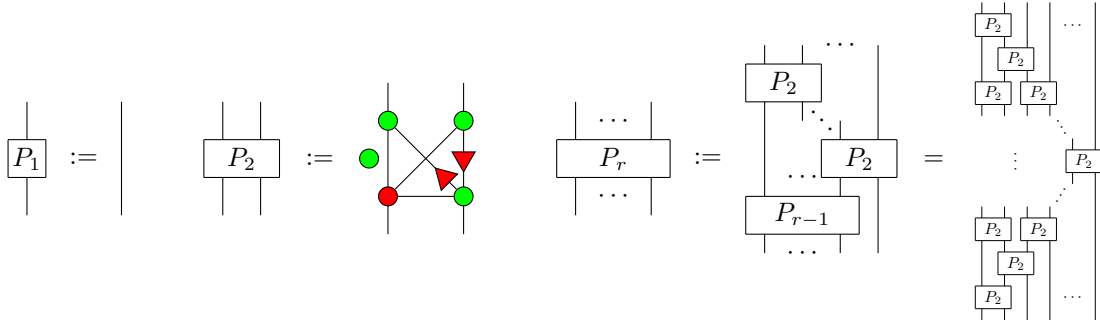

One can check that $\llbracket P_2 \rrbracket = \begin{pmatrix} 1 & 0 & 0 & 0 \\ 0 & 0 & 1 & 0 \\ 0 & 0 & 1 & 0 \\ 0 & 0 & 0 & 1 \end{pmatrix}$ from which, thanks to [16], we can immediately deduce that P_r is a projector onto span $\left\{ \left[\left(\begin{array}{c} \bullet \\ \circlearrowright \end{array} \right)^{\otimes r} \right] / \alpha \in \mathbb{R} \right\}$. It results that:

Lemma 1. For any $r \geq 1$ and any α -free diagrams $D_1, D_2 : r \rightarrow n$,

$$\left(\forall \alpha \in \mathbb{R}, \left[\begin{array}{c} \bullet \dots \bullet \\ \hline D_1 \\ \hline \dots \end{array} \right] = \left[\begin{array}{c} \bullet \dots \bullet \\ \hline D_2 \\ \hline \dots \end{array} \right] \right) \iff \left[\begin{array}{c} \dots \\ \hline P_r \\ \hline \dots \\ \hline D_1 \\ \hline \dots \end{array} \right] = \left[\begin{array}{c} \dots \\ \hline P_r \\ \hline \dots \\ \hline D_2 \\ \hline \dots \end{array} \right]$$

Hence, $\forall \alpha \in \mathbb{R}, \left[\begin{array}{c} \dots \\ \hline D_1(\alpha) \\ \hline \dots \end{array} \right] = \left[\begin{array}{c} \dots \\ \hline D_2(\alpha) \\ \hline \dots \end{array} \right] \iff \left[\begin{array}{c} \dots \\ \hline P_r \\ \hline \dots \\ \hline D'_1 \\ \hline \dots \end{array} \right] = \left[\begin{array}{c} \dots \\ \hline P_r \\ \hline \dots \\ \hline D'_2 \\ \hline \dots \end{array} \right]$.

Since D'_1, D'_2 and P_r are ΔZX_π -diagrams, the equality of diagrams on the right hand-side is

provable: $\left[\begin{array}{c} \dots \\ \hline P_r \\ \hline \dots \\ \hline D'_1 \\ \hline \dots \end{array} \right] = \left[\begin{array}{c} \dots \\ \hline P_r \\ \hline \dots \\ \hline D'_2 \\ \hline \dots \end{array} \right] \iff \left[\begin{array}{c} \dots \\ \hline P_r \\ \hline \dots \\ \hline D'_1 \\ \hline \dots \end{array} \right] = \left[\begin{array}{c} \dots \\ \hline P_r \\ \hline \dots \\ \hline D'_2 \\ \hline \dots \end{array} \right]$

All we need now to finish adapting the result on linear diagrams is the following property:

$$\begin{array}{|c|} \bullet \dots \bullet \\ \hline P_r \\ \hline \dots \end{array} = \begin{array}{|c|} \bullet \\ \dots \end{array}$$

This property is naturally obtained by induction in the general case provided it is true for the base cases $r \in \{1, 2\}$. When $r = 1$, the result is obvious. When $r = 2$, it deduces easily from:

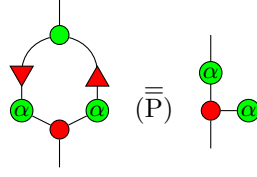

In this case:

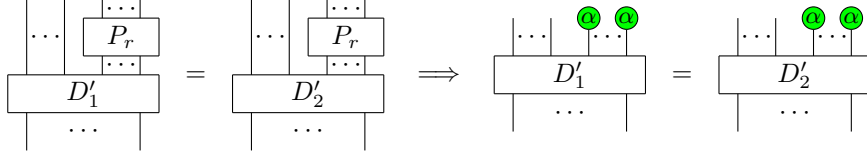

so finally: $\forall \alpha \in \mathbb{R}, \llbracket D_1(\alpha) \rrbracket = \llbracket D_2(\alpha) \rrbracket \iff D_1(\alpha) = D_2(\alpha)$

The result extends naturally to the multi-variable-case.

In conclusion, provided we have the two equations (K) and (P) as axioms, we can prove any sound equation on linear diagrams with constants in $\{0, \pi\}$. With $\Delta ZX^{K,P}$ denoting the axiomatisation ΔZX augmented with the rules (K) and (P):

Theorem 3. For any ΔZX -diagrams $D_1(\alpha)$ and $D_2(\alpha)$ linear in $\alpha = \alpha_1, \dots, \alpha_k$ with constants in $\{0, \pi\}$:

$$\forall \alpha \in \mathbb{R}^k, \llbracket D_1(\alpha) \rrbracket = \llbracket D_2(\alpha) \rrbracket \iff \forall \alpha \in \mathbb{R}^k, \Delta ZX^{K,P} \vdash D_1(\alpha) = D_2(\alpha)$$

We give two corollaries of this theorem:

Corollary 1.

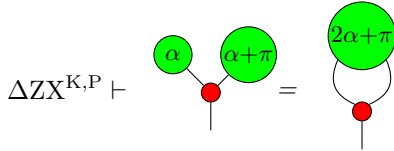

Corollary 2.

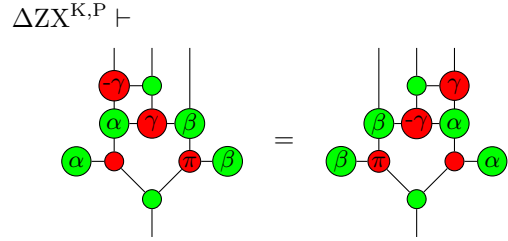

5 Axiomatisation for Clifford+T

With the addition of the rules (K) and (P), and the result on linear diagrams (Theorem 3), we feel like we are not far from having a complete axiomatisation for the $\frac{\pi}{4}$ -fragment of the ΔZX -Calculus. However:

Lemma 2 ([17]). $\Delta ZX^{K,P} \not\vdash$ $(\overline{\text{E}})$

The language here is different than in [17], but the argument is easily adaptable.

We give a larger axiomatisation denoted $\Delta ZX^{K,P,E}$ in Figure 3. This axiomatisation condenses the initial one (ΔZX) and the rules (K) and (P), but also replaces (IV) by (E), though it is very easy to show that the new axiomatisation proves the initial one:

Proposition 6. $\Delta ZX^{K,P,E} \vdash \Delta ZX$.

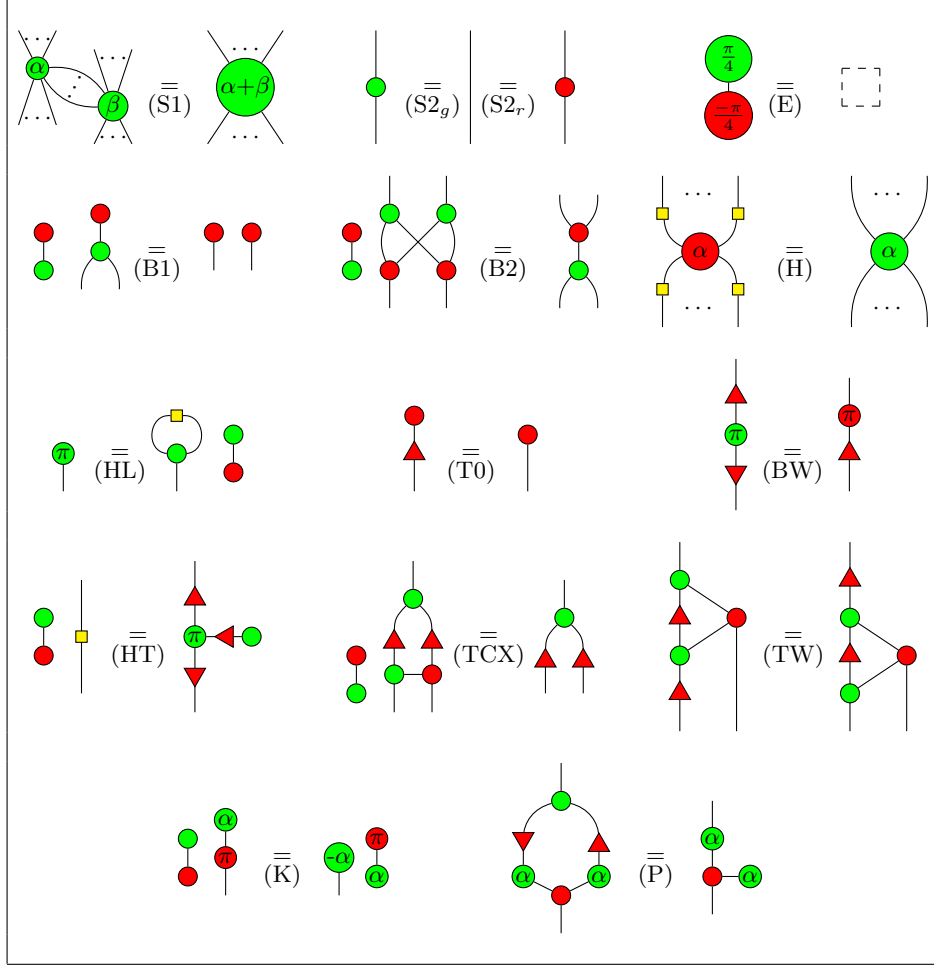

Fig. 3. Set of rules $\Delta ZX^{K,P,E}$. The right-hand side of (E) is an empty diagram. (...) denote zero or more wires, while (· ·) denote one or more wires.

Proof. All the equations in Figure 1 are present in the new axiomatisation, except (IV). Proving it from (S1), (S2), (B1), (B2) and (E), however, is classical [17]. \square

As a consequence, this axiomatisation is complete for the π -fragment of the ΔZX -Calculus. It turns out, it is also complete for the $\frac{\pi}{4}$ -fragment of the ΔZX -Calculus:

Theorem 4. *The set of rules $\Delta ZX_{\frac{\pi}{4}}^{K,P,E}$ makes the $\frac{\pi}{4}$ -fragment of the ΔZX -Calculus complete. For any D_1 and D_2 diagrams of this fragment:*

$$\llbracket D_1 \rrbracket = \llbracket D_2 \rrbracket \iff \Delta ZX_{\frac{\pi}{4}}^{K,P,E} \vdash D_1 = D_2$$

In contrast to the axiomatisations for Clifford+T in [15,21], $\Delta ZX^{K,P,E}$ got rid of the axioms that were specific to particular angles outside $\{0, \pi\}$, except for (E), which is necessary.

We end up with an axiomatisation for an augmented ZX-Calculus that is complete for the $\frac{\pi}{4}$ -fragment, as in [21]. However, the method used to achieve completeness is different: in [21], the authors start from an axiomatisation which is complete in general, and adapt it to the $\frac{\pi}{4}$ -fragment, whereas in this paper, we began with the easiest fragment of ΔZX , and gradually built upon it. As a result, the axiomatisation $\Delta ZX^{K,P,E}$ uses fewer axioms (14 against ~ 30) and one fewer generator.

The completeness result on linear diagrams with constants in $\{0, \pi\}$ (Theorem 3) can be seen as a generalisation of the completeness of ΔZX_{π} (Theorem 2). Similarly, the completeness result for $\Delta ZX_{\frac{\pi}{4}}^{K,P,E}$ (Theorem 4) can be generalised to linear diagrams:

Theorem 5. For any ΔZX -diagrams $D_1(\alpha)$ and $D_2(\alpha)$ linear in $\alpha = \alpha_1, \dots, \alpha_k$ with constants in $\frac{\pi}{4}\mathbb{Z}$:

$$\forall \alpha \in \mathbb{R}^k, \llbracket D_1(\alpha) \rrbracket = \llbracket D_2(\alpha) \rrbracket \iff \forall \alpha \in \mathbb{R}^k, \Delta ZX^{K,P,E} \vdash D_1(\alpha) = D_2(\alpha)$$

Acknowledgement

The author acknowledges support from the projects ANR-17-CE25-0009 SoftQPro, ANR-17-CE24-0035 VanQuTe, PIA-GDN/Quantex, and STIC-AmSud 16-STIC-05 FoQCoSS. All diagrams were written with the help of TikZit. The author would like to thank Emmanuel Jeandel and Simon Perdrix for fruitful discussions and suggestions.

References

1. Dorit Aharonov (2003): *A Simple Proof that Toffoli and Hadamard are Quantum Universal*. eprint arXiv:quant-ph/0301040.
2. Miriam Backens (2014): *The ZX-calculus is complete for stabilizer quantum mechanics*. *New Journal of Physics* 16(9), p. 093021. Available at <http://stacks.iop.org/1367-2630/16/i=9/a=093021>.
3. Miriam Backens (2014): *The ZX-calculus is complete for the single-qubit Clifford+T group*. *Electronic Proceedings in Theoretical Computer Science*, doi:10.4204/EPTCS.172.21.
4. Niel de Beaudrap & Dominic Horsman (2017): *The ZX calculus is a language for surface code lattice surgery*. In: *QPL 2017*. Available at <https://arxiv.org/abs/1704.08670>.
5. Nicholas Chancellor, Aleks Kissinger, Joschka Roffe, Stefan Zohren & Dominic Horsman (2016): *Graphical Structures for Design and Verification of Quantum Error Correction*. Available at <https://arxiv.org/abs/1611.08012>.
6. Bob Coecke & Ross Duncan (2011): *Interacting quantum observables: categorical algebra and diagrammatics*. *New Journal of Physics* 13(4), p. 043016. Available at <http://stacks.iop.org/1367-2630/13/i=4/a=043016>.
7. Bob Coecke & Aleks Kissinger (2010): *The Compositional Structure of Multipartite Quantum Entanglement*, pp. 297–308. Springer Berlin Heidelberg, Berlin, Heidelberg, doi:10.1007/978-3-642-14162-1_25. Available at http://dx.doi.org/10.1007/978-3-642-14162-1_25.
8. Bob Coecke & Aleks Kissinger (2017): *Picturing Quantum Processes: A First Course in Quantum Theory and Diagrammatic Reasoning*. Cambridge University Press, doi:10.1017/9781316219317.
9. Ross Duncan & Maxime Lucas (2014): *Verifying the Steane code with Quantomatic*. *Electronic Proceedings in Theoretical Computer Science* 171, pp. 33–49, doi:10.4204/EPTCS.171.4.
10. Ross Duncan & Simon Perdrix (2010): *Rewriting measurement-based quantum computations with generalised flow*. *Lecture Notes in Computer Science* 6199, pp. 285–296, doi:10.1007/978-3-642-14162-1_24. Available at <http://personal.strath.ac.uk/ross.duncan/papers/gflow.pdf>.
11. Ross Duncan & Simon Perdrix (2013): *Pivoting makes the ZX-calculus complete for real stabilizers*. In: *QPL 2013*, *Electronic Proceedings in Theoretical Computer Science*, pp. 50–62, doi:10.4204/EPTCS.171.5.
12. Amar Hadzihasanovic (2015): *A Diagrammatic Axiomatisation for Qubit Entanglement*. In: *2015 30th Annual ACM/IEEE Symposium on Logic in Computer Science*, pp. 573–584, doi:10.1109/LICS.2015.59.
13. Amar Hadzihasanovic (2017): *The algebra of entanglement and the geometry of composition*. Ph.D. thesis, University of Oxford. Available at <https://arxiv.org/abs/1709.08086>.
14. Clare Horsman (2011): *Quantum picturalism for topological cluster-state computing*. *New Journal of Physics* 13(9), p. 095011. Available at <http://stacks.iop.org/1367-2630/13/i=9/a=095011>.
15. Emmanuel Jeandel, Simon Perdrix & Renaud Vilmart (2017): *A Complete Axiomatisation of the ZX-Calculus for Clifford+T Quantum Mechanics*. Accepted at LiCS 2018. Available at <https://hal.archives-ouvertes.fr/hal-01529623>.
16. Emmanuel Jeandel, Simon Perdrix & Renaud Vilmart (2018): *Diagrammatic Reasoning beyond Clifford+T Quantum Mechanics*. Accepted at LiCS 2018. Available at <https://arxiv.org/abs/1801.10142>.
17. Emmanuel Jeandel, Simon Perdrix, Renaud Vilmart & Quanlong Wang (2017): *ZX-Calculus: Cyclo-tomic Supplementarity and Incompleteness for Clifford+T Quantum Mechanics*. In Kim G. Larsen, Hans L. Bodlaender & Jean-Francois Raskin, editors: *42nd International Symposium on Mathematical Foundations of Computer Science (MFCS 2017)*, *Leibniz International Proceedings in Informatics (LIPIcs)* 83, Schloss Dagstuhl–Leibniz-Zentrum fuer Informatik, Dagstuhl, Germany, pp. 11:1–11:13, doi:10.4230/LIPIcs.MFCS.2017.11. Available at <http://drops.dagstuhl.de/opus/volltexte/2017/8117>.

18. A. Kissinger, L. Dixon, R. Duncan, B. Frot, A. Merry, D. Quick, M. Soloviev & V. Zamdzhiev (2011): *Quantomatic*. Available at <https://sites.google.com/site/quantomatic/>.
19. Aleks Kissinger & Vladimir Zamdzhiev (2015): *Quantomatic: A Proof Assistant for Diagrammatic Reasoning*. In Amy P. Felty & Aart Middeldorp, editors: *Automated Deduction - CADE-25*, Springer International Publishing, Cham, pp. 326–336, doi:10.1007/978-3-319-21401-6_22.
20. Kang Feng Ng & Quanlong Wang (2017): *A universal completion of the ZX-calculus*. Available at <https://arxiv.org/abs/1706.09877>.
21. Kang Feng Ng & Quanlong Wang (2018): *Completeness of the ZX-calculus for Pure Qubit Clifford+T Quantum Mechanics*. Available at <https://arxiv.org/abs/1801.07993>.
22. Michael A. Nielsen & Isaac L. Chuang (2010): *Quantum Computation and Quantum Information: 10th Anniversary Edition*. Cambridge University Press, doi:10.1017/CBO9780511976667.
23. Peter Selinger (2013): *Quantum circuits of T-depth one*. *Phys. Rev. A* 87, p. 042302, doi:10.1103/PhysRevA.87.042302. Available at <https://link.aps.org/doi/10.1103/PhysRevA.87.042302>.
24. Yaoyun Shi (2003): *Both Toffoli and controlled-NOT Need Little Help to Do Universal Quantum Computing*. *Quantum Info. Comput.* 3(1), pp. 84–92. Available at <http://dl.acm.org/citation.cfm?id=2011508.2011515>.

A Appendix

A.1 Lemmas

Lemma 3.

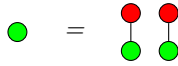

Lemma 4.

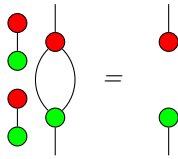

Lemma 5.

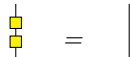

Lemma 6.



Lemma 7.

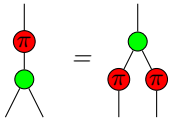

Lemma 8.

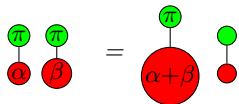

Lemma 9.

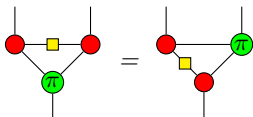

Lemma 10.

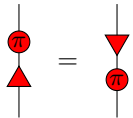

Lemma 11.

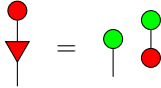

Lemma 12.

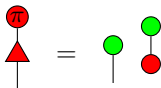

Lemma 13.

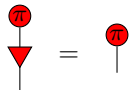

Lemma 14.

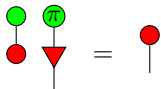

Lemma 15.

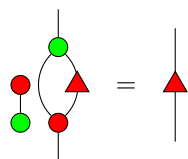

Lemma 16.

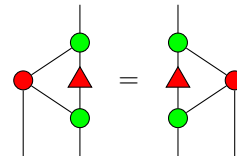

Lemma 17.

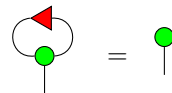

Lemma 18.

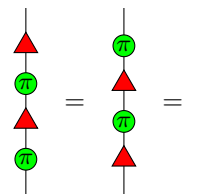

Lemma 19.

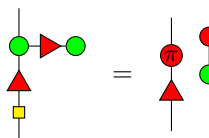

Lemma 20.

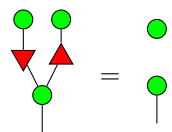

Lemma 21.

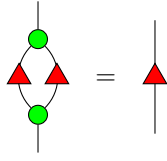

Lemma 23.

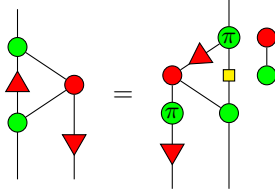

Lemma 25.

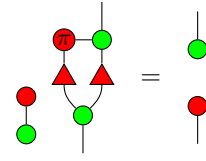

Lemma 22.

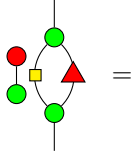

Lemma 24.

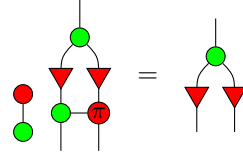

A.2 Proof of Lemmas

Proof (Lemmas 3, 4, 6, 7, 9). By completeness of the π -fragment of the ZX-Calculus, which uses a subset of ZX as axioms [11]. \square

Proof (Lemma 8). This proof is classical and uses 7, (B1) and (S1). The proof is the same whatever the values of α and β are. \square

Proof (Lemma 10).

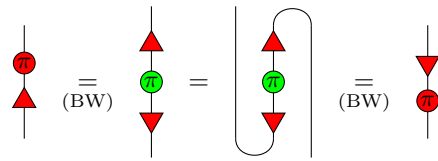

\square

Proof (Lemma 11).

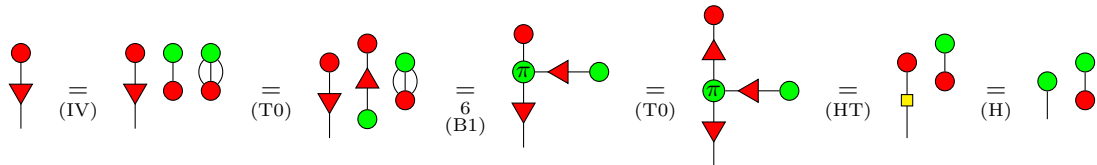

\square

Proof (Lemma 12).

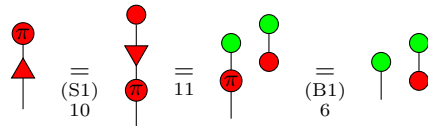

\square

Proof (Lemma 13).

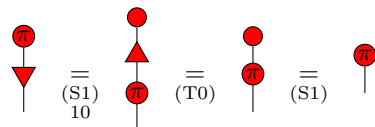

\square

Proof (Lemma 14).

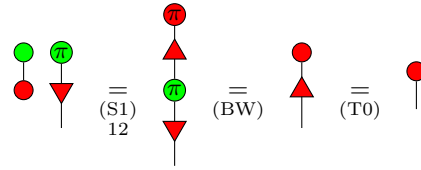

□

Proof (Lemma 15).

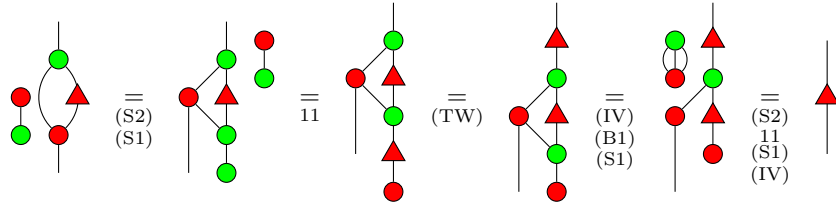

□

Proof (Lemma 16).

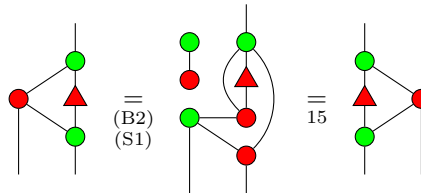

□

Proof (Lemma 17).

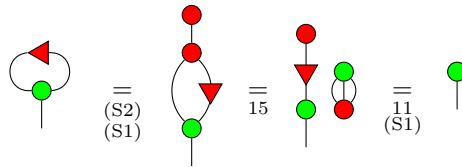

□

Proof (Lemma 18).

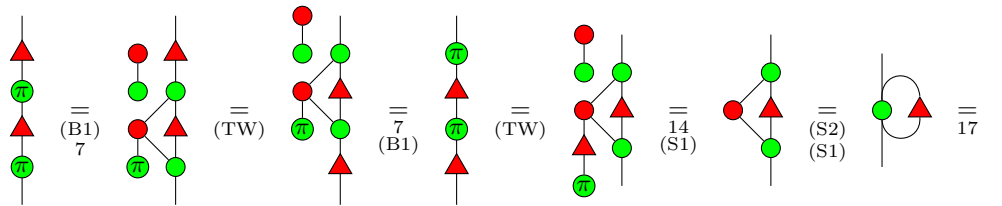

□

Proof (Lemma 19).

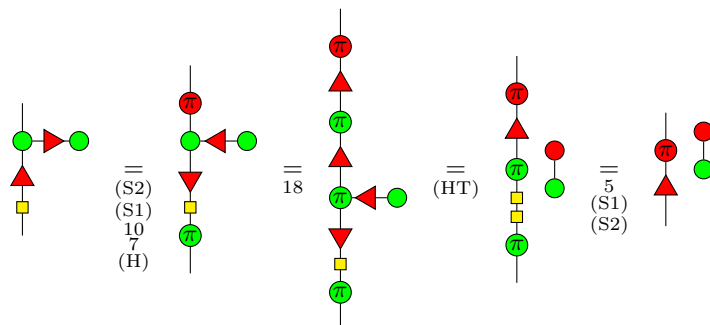

□

Proof (Lemma 20).

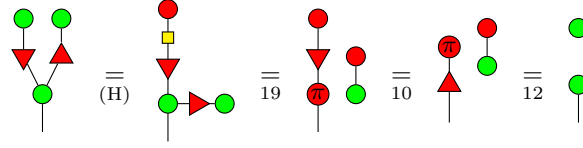

□

Proof (Lemma 21).

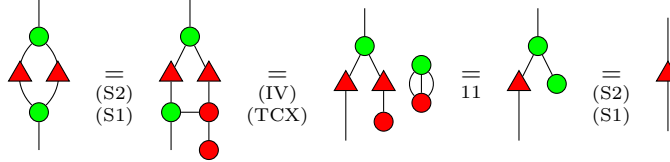

□

Proof (Lemma 22).

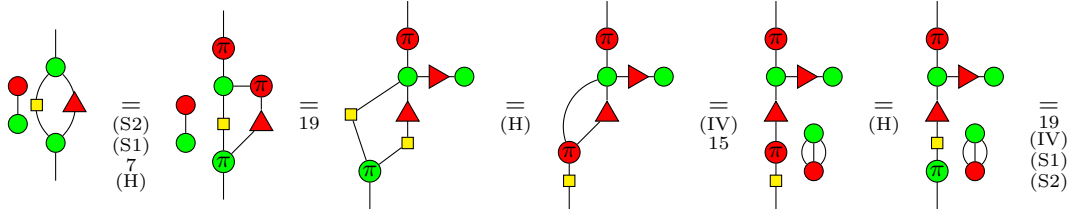

□

Proof (Lemma 23). First:

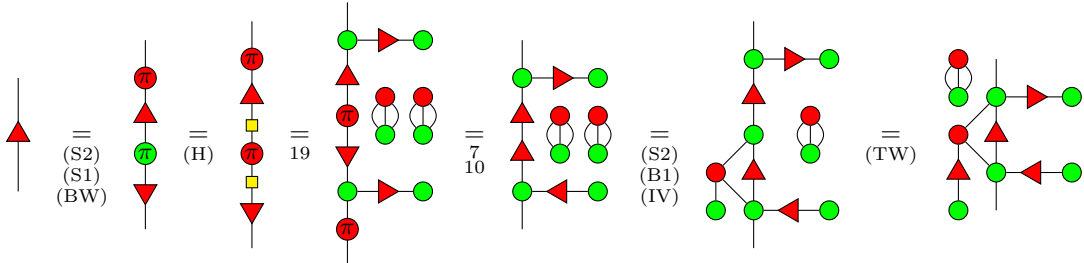

Moreover, from 19, we can easily derive:

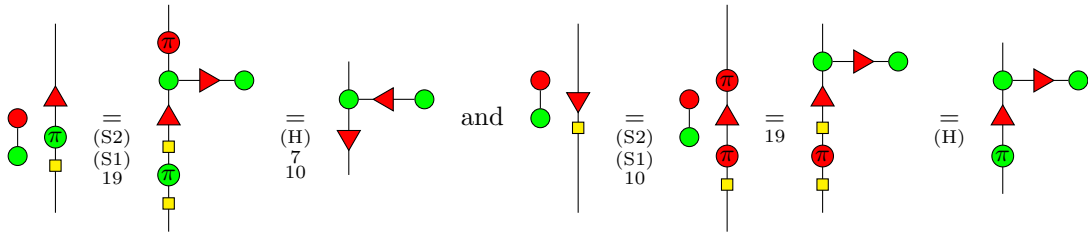

Finally:

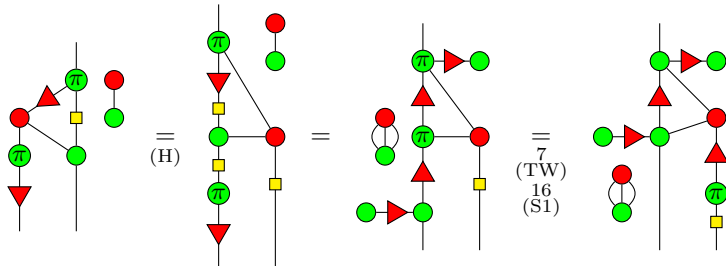

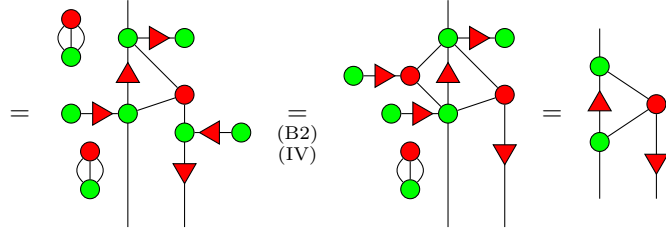

□

Proof (Lemma 24).

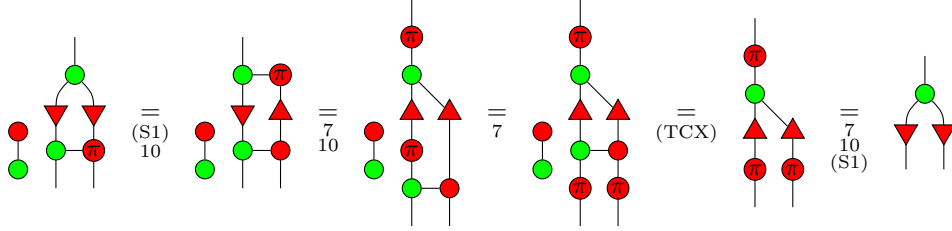

□

Proof (Lemma 25).

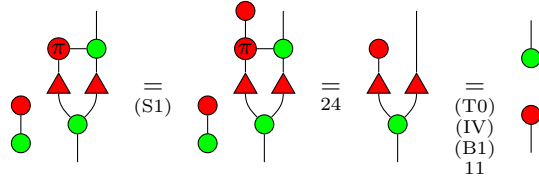

□

A.3 Two Additional Corollaries of Theorem 3

Corollary 3.

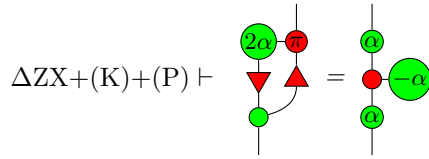

Corollary 4.

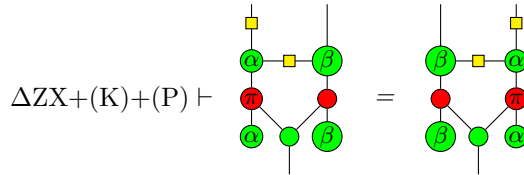

A.4 Proofs for Completeness

Proof (Proposition 1). Soundness is obvious, since the rule *iv* is sound.

Now let D_1 and D_2 be two diagrams of the $ZW_{\frac{1}{\sqrt{2}}}$ -Calculus such that $\llbracket D_1 \rrbracket = \llbracket D_2 \rrbracket$. We can rewrite D_1 and D_2 as $D_i = d_i \otimes (\star)^{\otimes n_i}$ for some integers n_i and diagrams d_i of the ZW-Calculus that do not use the \star symbol. Notice that $d_1 = d_2 \pmod{2}$. Indeed $\llbracket D_1 \rrbracket = \llbracket D_2 \rrbracket \implies \frac{\llbracket d_1 \rrbracket}{\sqrt{2}^{n_1}} = \frac{\llbracket d_2 \rrbracket}{\sqrt{2}^{n_2}}$. Since $\llbracket d_i \rrbracket$ are matrices over \mathbb{Z} , n_1 and n_2 are either both odd or both even.

First, suppose $n_i = 0 \pmod 2$. From the new introduced rule, we get that $ZW_{\frac{1}{\sqrt{2}}} \vdash d_i = D_i \otimes (\bigcirc)^{\otimes \frac{n_i}{2}}$. W.l.o.g. assume $n_1 \leq n_2$. Then $\left[d_1 \otimes (\bigcirc)^{\otimes \frac{n_2-n_1}{2}} \right] = 2^{\frac{n_2-n_1}{2}} \llbracket d_1 \rrbracket = 2^{\frac{n_2}{2}} \llbracket D_1 \rrbracket = \llbracket d_2 \rrbracket$. Since $d_1 \otimes (\bigcirc)^{\otimes \frac{n_2-n_1}{2}}$ and d_2 are ZW-diagrams and have the same interpretation, thanks to the completeness of the ZW-Calculus, $ZW_{\frac{1}{\sqrt{2}}} \vdash d_1 \otimes (\bigcirc)^{\otimes \frac{n_2-n_1}{2}} = d_2$, which implies $ZW_{\frac{1}{\sqrt{2}}} \vdash d_1 \otimes (\bigcirc)^{\otimes \frac{n_2-n_1}{2}} \otimes (\star)^{\otimes n_2} = d_2 \otimes (\star)^{\otimes n_2}$ i.e. $ZW_{\frac{1}{\sqrt{2}}} \vdash D_1 = D_2$.

Now, we can easily show $ZW_{\frac{1}{\sqrt{2}}} \vdash D_1 \otimes \star = D_2 \otimes \star \iff ZW_{\frac{1}{\sqrt{2}}} \vdash D_1 = D_2$, proving the result when $n_i = 1 \pmod 2$:

$$\begin{aligned} ZW_{\frac{1}{\sqrt{2}}} \vdash D_1 \otimes \star = D_2 \otimes \star &\implies ZW_{\frac{1}{\sqrt{2}}} \vdash D_1 \otimes \star \star \bigcirc = D_2 \otimes \star \star \bigcirc \\ &\stackrel{iv}{\implies} ZW_{\frac{1}{\sqrt{2}}} \vdash D_1 = D_2 \implies ZW_{\frac{1}{\sqrt{2}}} \vdash D_1 \otimes \star = D_2 \otimes \star \end{aligned}$$

□

Proof (Proposition 3). We prove¹ here that all the rules of the $ZW_{\frac{1}{\sqrt{2}}}$ -Calculus are preserved by $[\cdot]_X$.

- X:

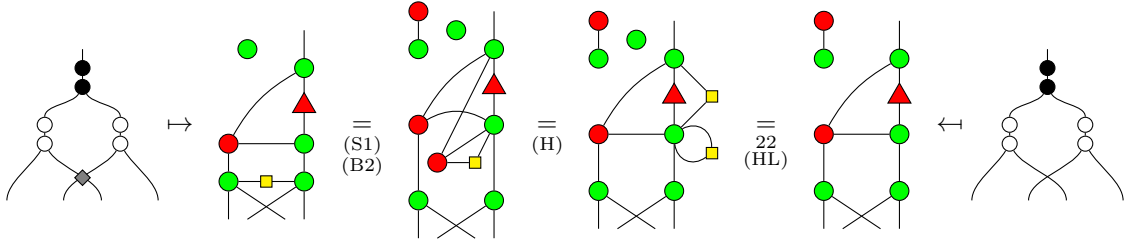

- 0a, 0c, 0d and 0d' come directly from the paradigm *Only Topology Matters*.
- 0b:

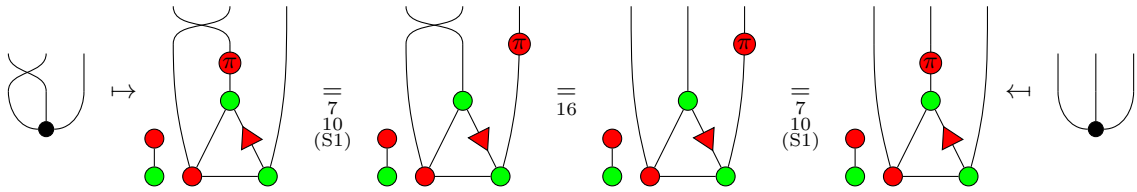

- 0b': Using the result for rule 0b,

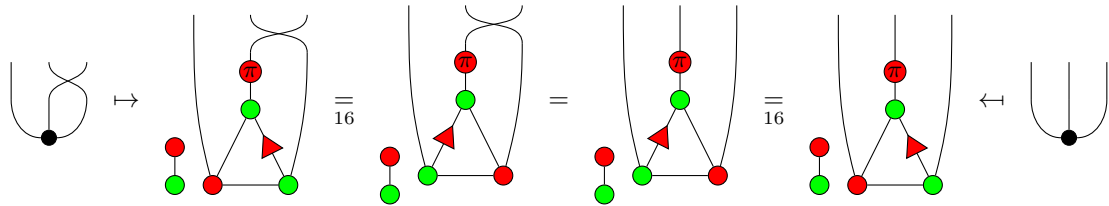

¹ The proof is strictly the same as in [15]. We give it again here for coherence and to guarantee that all the necessary lemmas have been proven.

• 1a:

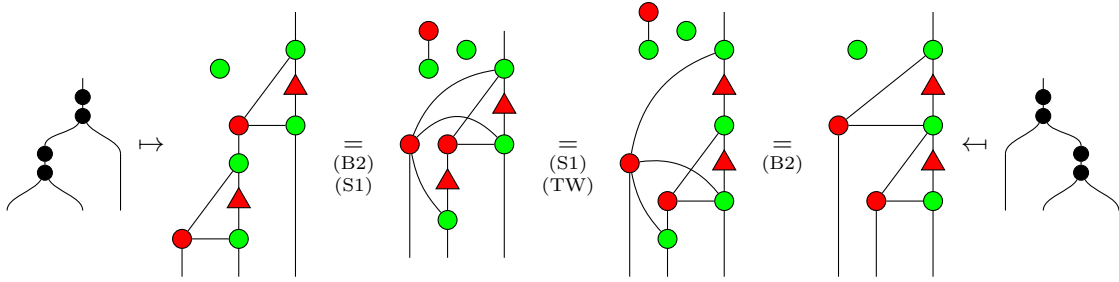

• 1b:

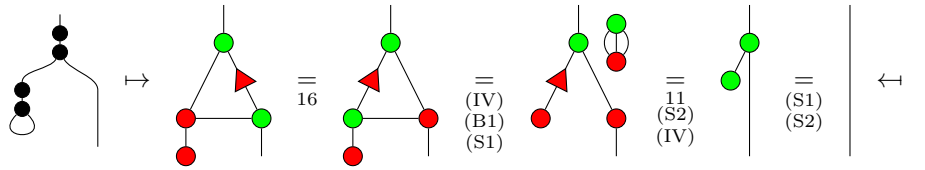

• 1c, 1d, 2a and 2b come directly from the spider rules (S1) and (S2).

• 3a is Lemma 7.

• 3b:

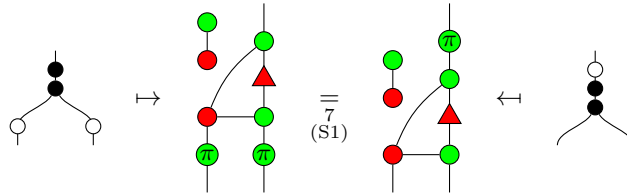

• 4 comes from the spider rule (S1).

• 5a: We will need a few steps to prove this equality.

i)

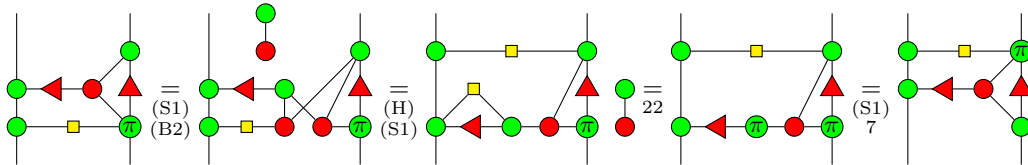

ii)

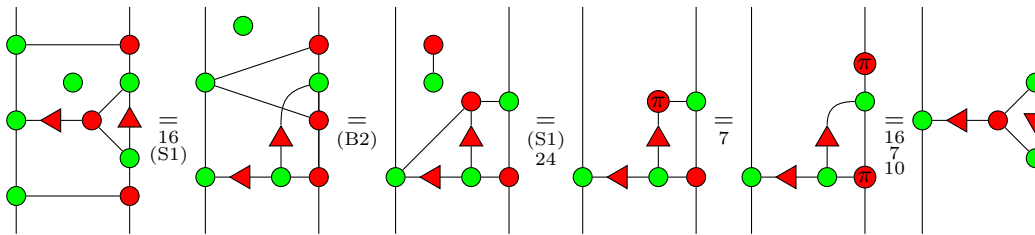

iii)

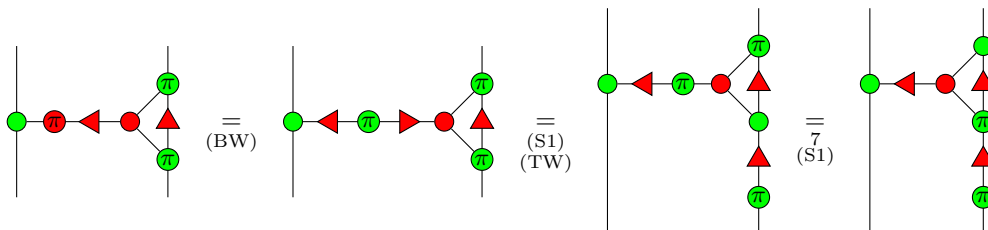

iv)

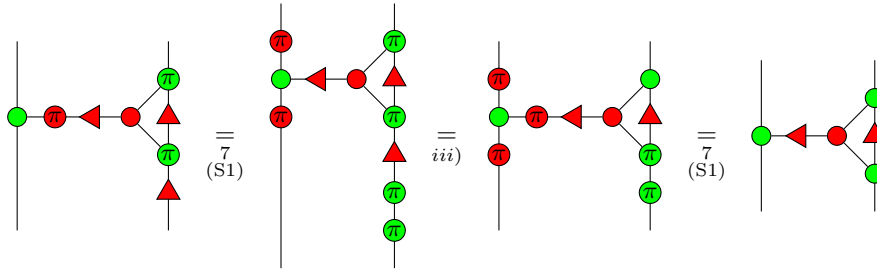

v)

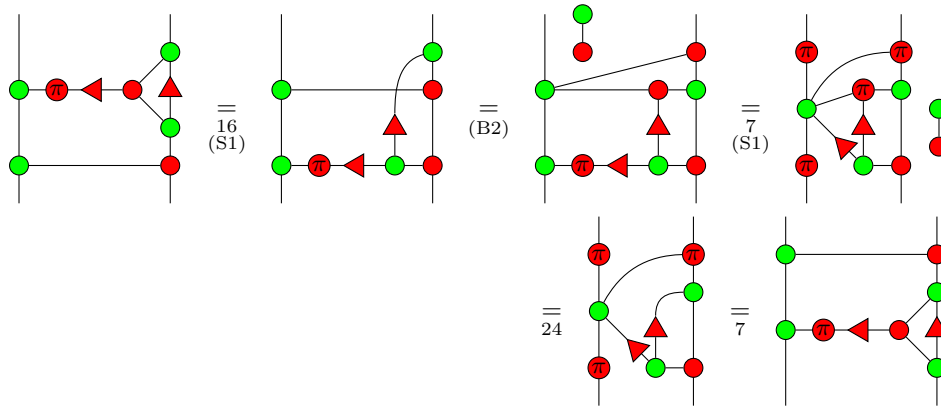

vi)

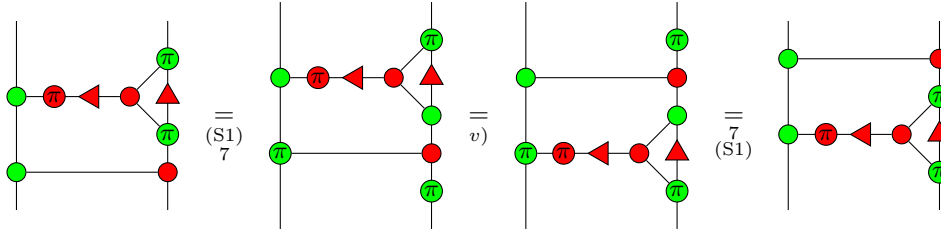

vii)

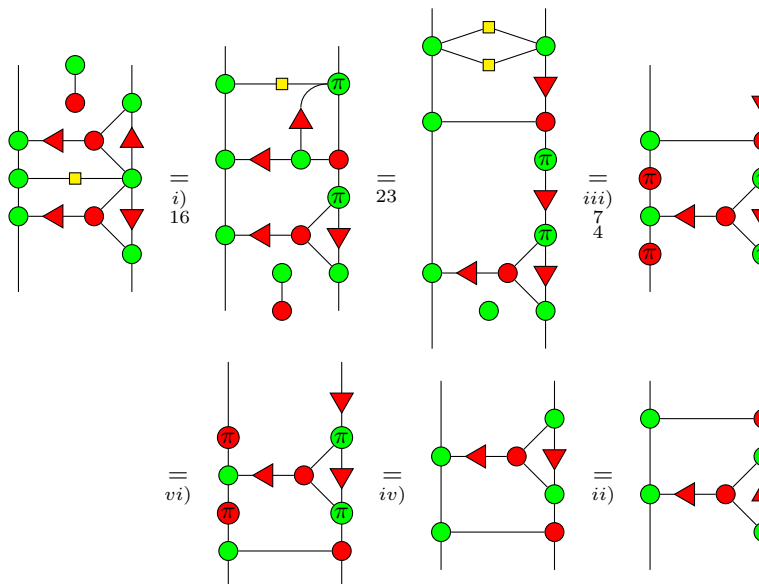

viii)

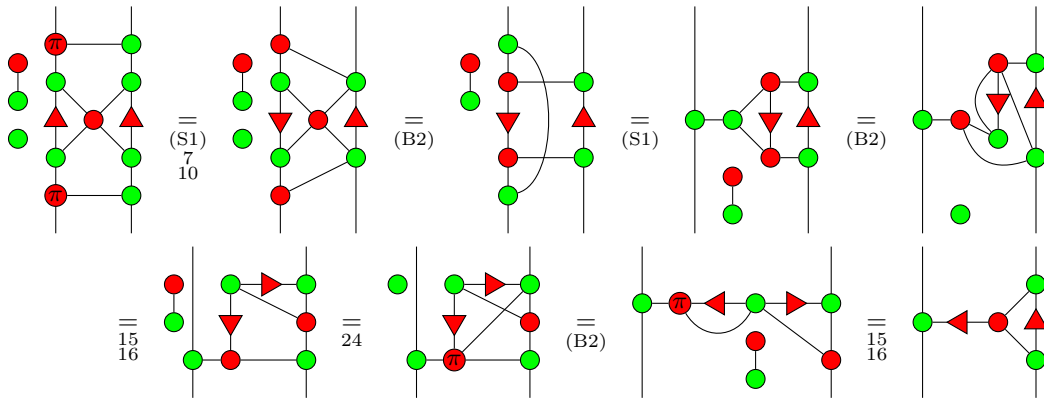

Finally,

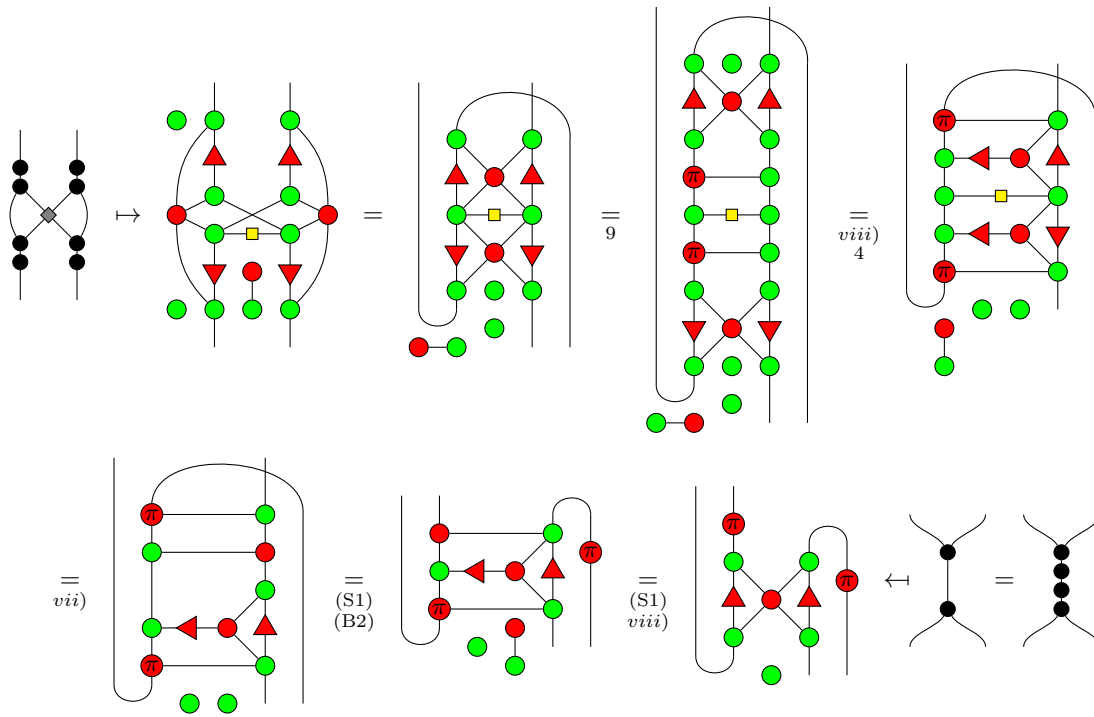

• 5b:

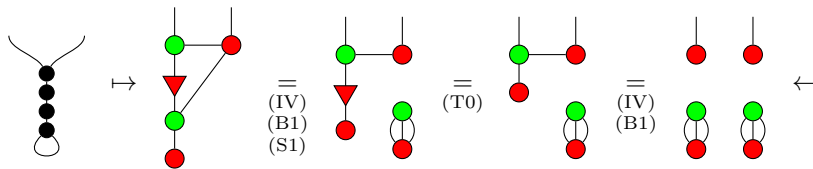

• 5c:

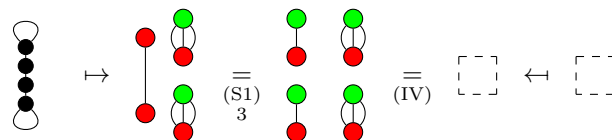

• 5d:

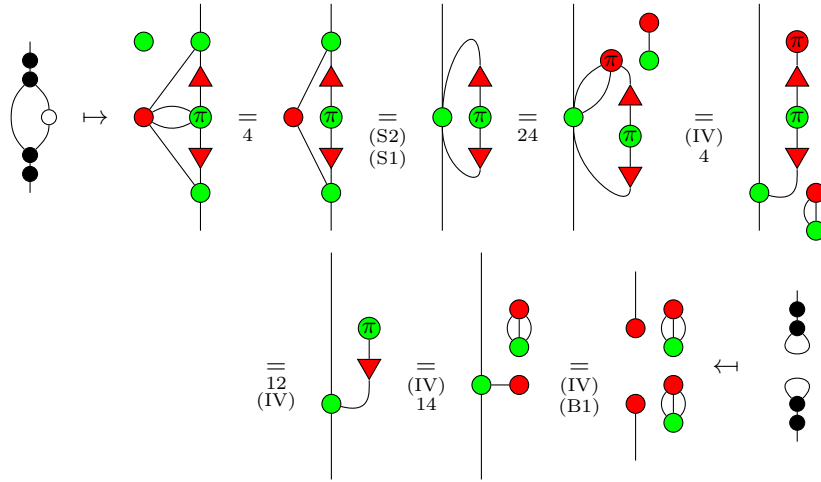

• 6a: Thanks to the rule X we can get rid of $\begin{array}{c} \bullet \\ \square \\ \bullet \end{array}$ induced by the crossing. Then,

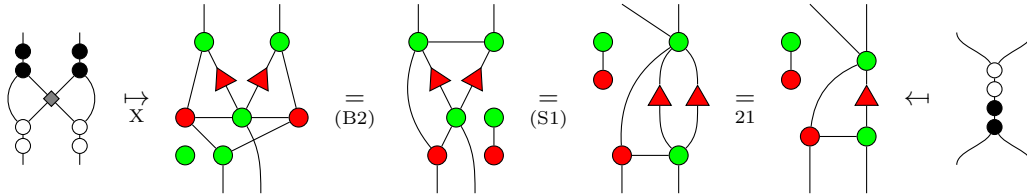

• 6b is exactly the copy rule (B1).

• 6c:

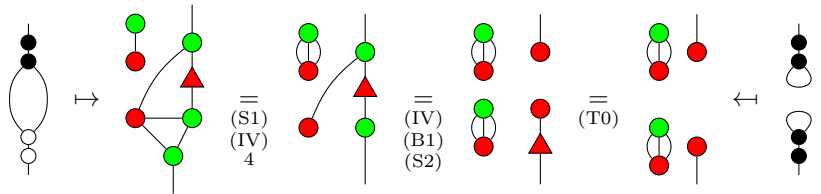

• 7a:

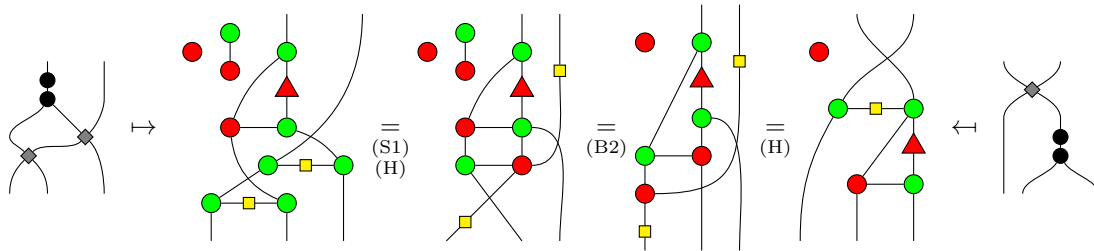

• 7b:

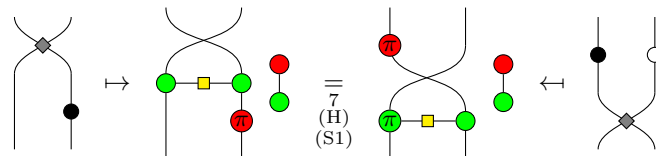

• R₂:

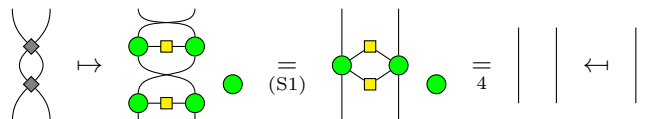

• R_3 :

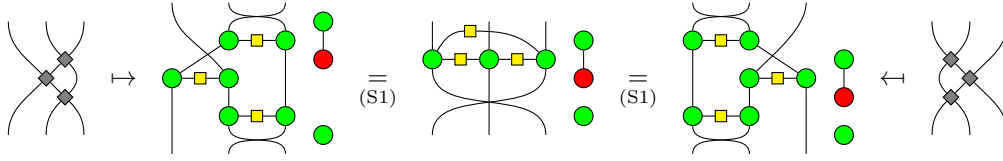

• iv :

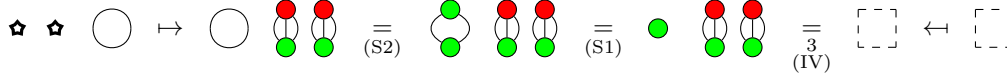

□

Proof (Theorem 4). We remind the rules that make the $\frac{\pi}{4}$ -fragment complete [15]:

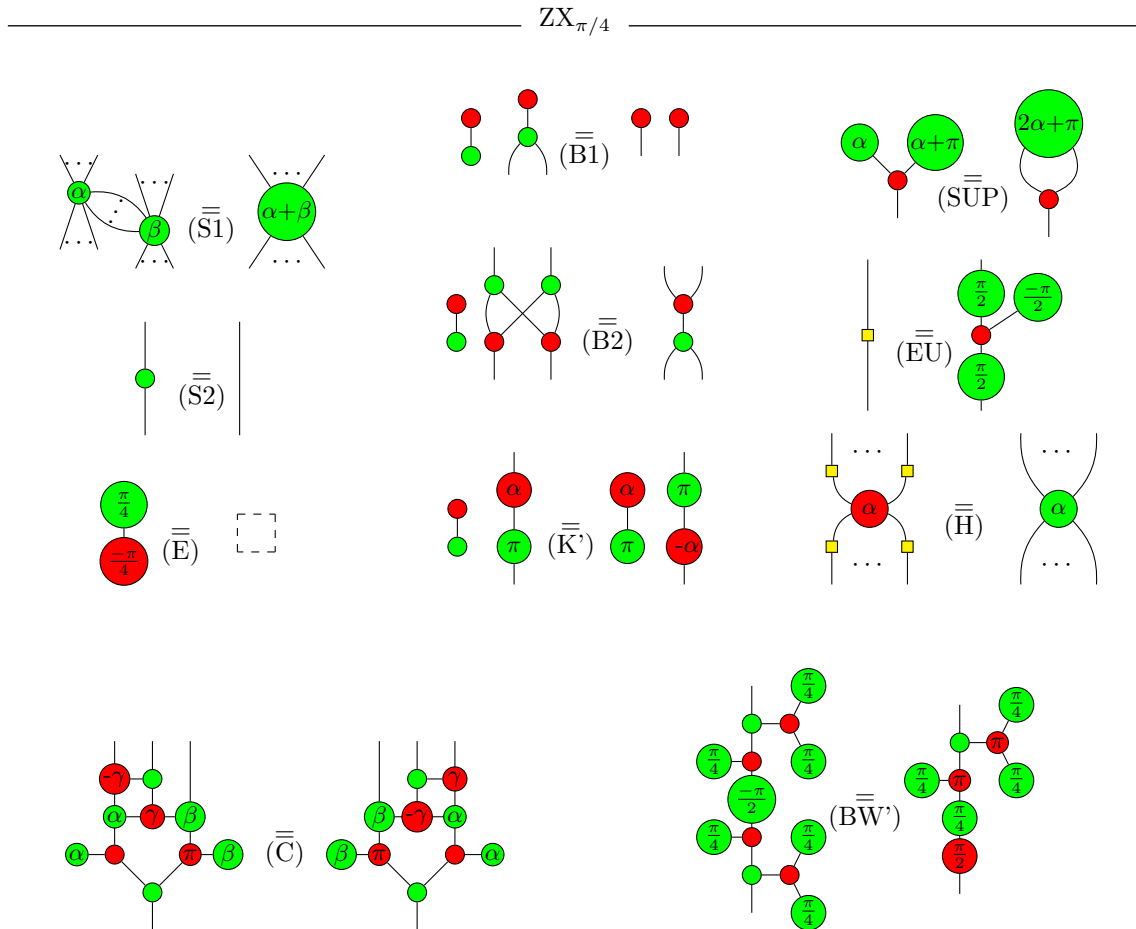

We will prove that they are derivable from $\Delta ZX_{\pi/4}^{K,P,E}$.

Some of the rules are already present in $\Delta ZX_{\pi/4}^{K,P,E}$: (S1), (S2), (E), (B1), (B2), (H). Thanks to Proposition 6, we can use Theorem 3. This proves that rules (C) and (SUP) are derivable from $\Delta ZX_{\pi/4}^{K,P,E}$ (Corollaries 2 and 1), as well as (K'). There only remain (EU) and (BW'). (BW) appears in $\Delta ZX_{\pi/4}^{K,P,E}$, but in its “triangle-form”. We need to prove that the triangle can be decomposed in the diagram of the $\frac{\pi}{4}$ -fragment used in [15].

The Euler decomposition of the Hadamard gate is derivable:

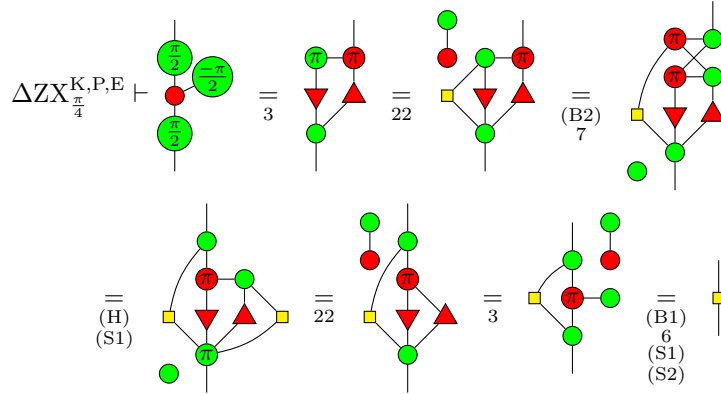

We now have proven all the axioms that make the $\frac{\pi}{2}$ -fragment complete. We can use it in the following (denoted $\frac{\pi}{2}$ -C). The decomposition of the triangle node is derivable:

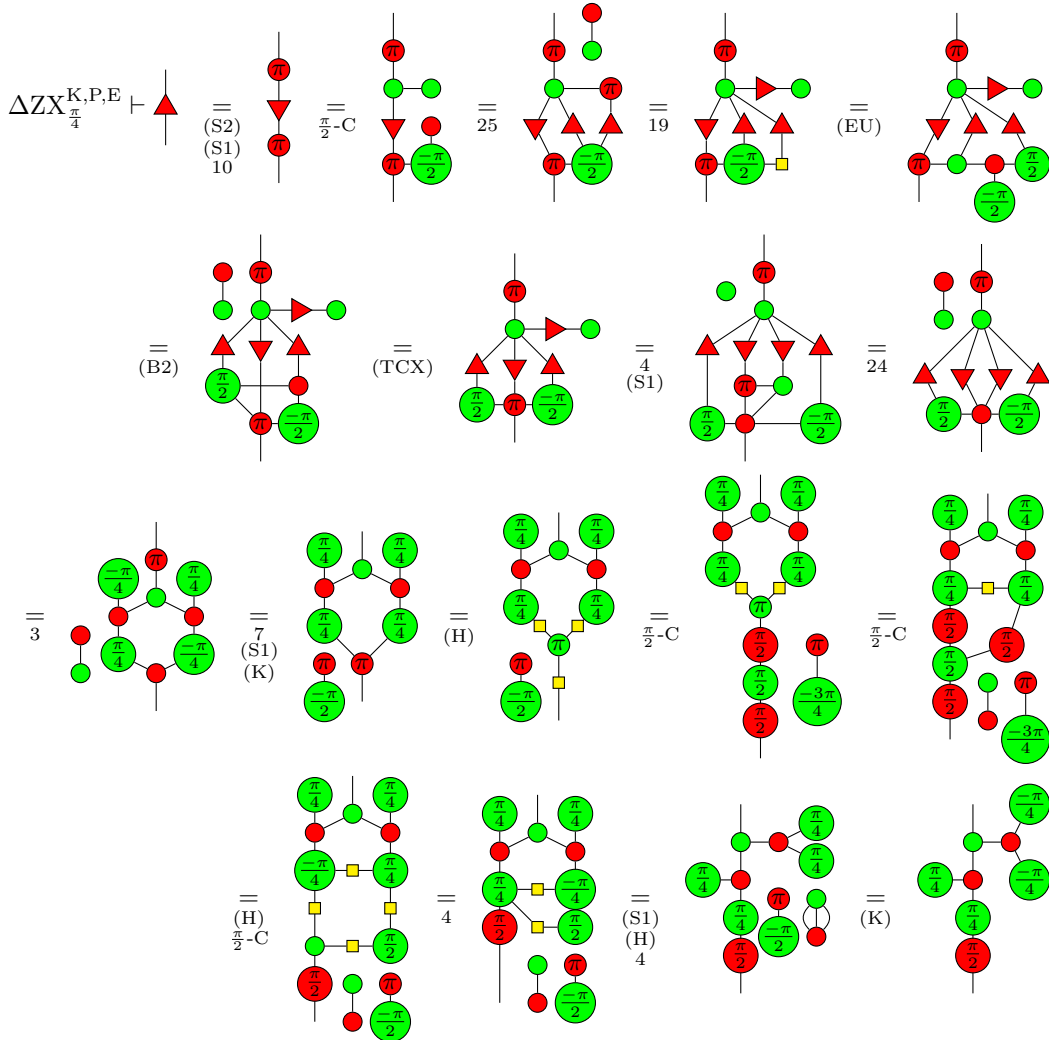

The rule (BW') is now easily derivable from the decomposition of the triangle and the rule (BW). \square