



HAL
open science

BEM-based cooling channel optimization for 3D injection molding

Nicolas Pirc, Florian Bugarin, Fabrice Schmidt, Marcel Mongeau

► **To cite this version:**

Nicolas Pirc, Florian Bugarin, Fabrice Schmidt, Marcel Mongeau. BEM-based cooling channel optimization for 3D injection molding. 1st International conference on multidisciplinary design optimization and application, Apr 2007, Besançon, France. 6 p. hal-01760294

HAL Id: hal-01760294

<https://hal.science/hal-01760294>

Submitted on 5 Mar 2019

HAL is a multi-disciplinary open access archive for the deposit and dissemination of scientific research documents, whether they are published or not. The documents may come from teaching and research institutions in France or abroad, or from public or private research centers.

L'archive ouverte pluridisciplinaire **HAL**, est destinée au dépôt et à la diffusion de documents scientifiques de niveau recherche, publiés ou non, émanant des établissements d'enseignement et de recherche français ou étrangers, des laboratoires publics ou privés.

3D BEM-based cooling-channel shape optimization for injection molding processes

N. Pirc^{*a}, F. Bugarin^{*}, F.M. Schmidt^{*}, M. Mongeau^a
(^{*})*CROME_P - Ecole des Mines d'Albi-Carmaux,*
Campus Jarlard, 81013 Albi, cedex 9, France

(^a)*LAAS-CNRS, Université de Toulouse and*
Institut de Mathématiques, Université Paul Sabatier
31062 Toulouse cedex 9, France

Abstract

Today, around 30 % of manufactured plastic goods rely on injection molding. The cooling time can represents more than 70 % of the injection cycle. Moreover, in order to avoid defects in the manufactured plastic parts, the temperature in the mold must be homogeneous. We propose in this paper a practical methodology to optimize both the position and the shape of the cooling channels in 3D injection molding processes. For the evaluation of the temperature required both by the objective and the constraint functions, we must solve 3D heat-transfer problems via numerical simulation. We solve the heat-transfer problem using Boundary Element Method (BEM). This yields a reduction of the dimension of the computational space from 3D to 2D, avoiding full 3D remeshing: only the surface of the cooling channels needs to be remeshed at each evaluation required by the optimization algorithm. We propose a general optimization model that attempts at minimizing the desired overall low temperature of the plastic-part surface subject to constraints imposing homogeneity of the temperature. Encouraging preliminary results on two semi-industrial plastic parts show that our optimization methodology is viable.

1 INTRODUCTION

Today, around 30 % of manufactured plastic goods rely on injection molding, which is based on the injection of a fluid plastic material into a closed mold (Figure 1 [14] displays an illustrative injection molding process). The cooling time can represent more than 70 % of the injection cycle. Moreover, in order to avoid defects in the manufactured plastic parts, the temperature in the mold must be homogeneous. Thus, the design and the position of the cooling channels are crucial elements in the design of the mold. In order to decide the position and the shape of the cooling channels in the mold, designers commonly rely on experience and intuition within a costly trial-and-error design process. This manual design process becomes inadequate and unpractical for complex problems. This is particularly true nowadays with rapid prototyping processes such as layered design or selective laser sintering that enable manufacturers to build almost any desired shape of cooling channel geometry in the mold. As a consequence, designers need a more power-

ful tool integrating the cooling analysis, its numerical simulation, and even optimization algorithms into the design process.

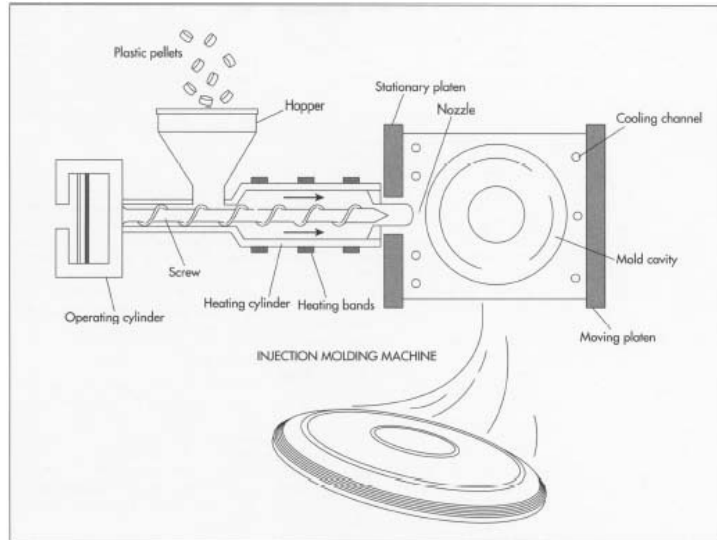

Figure 1: Temperature at the surface of the mold versus time

We propose in this paper a practical methodology to optimize both the position and the shape of the cooling channels in 3D injection molding processes.

For the evaluation of the temperature, required both by the objective and the constraint functions, we must solve 3D heat-transfer problems via numerical simulation. Severe numerical methods such as Finite Element Method (FEM) [1] or Boundary Element Method (BEM) [2] can be used for solving the heat-transfer problem. Silva [3] used 3D FEM software to model the injection molding cycle for complex geometries of molds. However, the computational burden of 3D FEM makes the integration of an optimization algorithm unpractical. Indeed, a FEM approach to the 3D heat-transfer problem imposes severe storage and CPU requirements, even if moderately complex industrial parts were to be targeted. An optimization algorithm requires numerous (and here expensive in CPU time) objective-function evaluations. Moreover, unless one knows a very good initial design, from one optimization iteration to the next the design is generally significantly different. As a consequence, the capability of FEM to handle (small) shape perturbations for 3D mesh cannot be advantageously exploited here. BEM is a method that was popularized by Brebbia [6]. It is used in many applications, such as gas-assisted injection molding processes [4], or groundwater flow and mass transport problems [5]. BEM transforms domain integrals into boundary element integrals, involving therefore a discretization restricted only to the external and internal field boundary. An optimization method can therefore be envisaged to modify the position and also the shape parameters of the cooling channels in order to improve the cooling performance of the mold.

Park [7] proposed such a BEM-based procedure for the position of the cooling channels relying on augmented-Lagrangian optimization method. However, his study is restricted to molds that are generalized cylinders, amenable to 2D molds. His optimization model minimizes the variations of the temperature distribution on the cavity surface with respect to the average temperature. As a consequence, his optimal configuration provides a uniform but high average temperature, leading a very long cooling time which is not desirable in the context of large-scale manufacturing. Mathey [8] also used BEM to solve the heat-transfer problems with a Sequential Quadratic Programming (SQP) [9] algorithm to improve mold injection cooling. She minimizes an objective function which is the weighted sum of two criteria. Her first criterion is the average temperature at the plastic-part surface. Her second criterion is the sum of the temperature variations with respect to the average temperature. Moreover, Mathey optimizes both the position *and* the shape of the cooling channels. However, her approach is also restricted to 2D molds (as for Park, BEM then reduces the dimension of the computation space from 2D to 1D).

Our contribution is threefold. First, we address 3D mold geometries with a BEM approach reducing the dimension of the computation space from 3D to 2D, avoiding full 3D remeshing: only the surface of the cooling channels needs to be re-meshed at each evaluation required by the optimization algorithm. Secondly, we propose a general optimization models that attempts at minimizing the desired overall low temperature of the plastic-part surface subject to constraints imposing homogeneity of the temperature. Thirdly, we demonstrate that our optimization methodology is viable with encouraging preliminary results on two semi-industrial plastic parts.

The paper is organized as follows. We detail in the next section the 3D heat-transfer problem that we must solve for every optimization evaluation of the temperature required by the optimization algorithm. Section 3 describes our overall optimization methodology. In order to validate our approach, we report encouraging preliminary results in Section 4. We conclude in Section 5.

2 THE HEAT TRANSFER PROBLEM

This section describes the heat-transfer problem that must be solved at every temperature evaluation required by the optimization algorithm:

As shown in Figure 2 [10], after a few cycles the variation of the temperature in the injection mold in production can be considered to be quasi-stationary. Once the average temperature of the mold is stabilized, the cycle-averaged approach can predict well the overall performance of the cooling system. Thus, we can consider a stationary regime neglecting the transitory oscillations of the temperature.

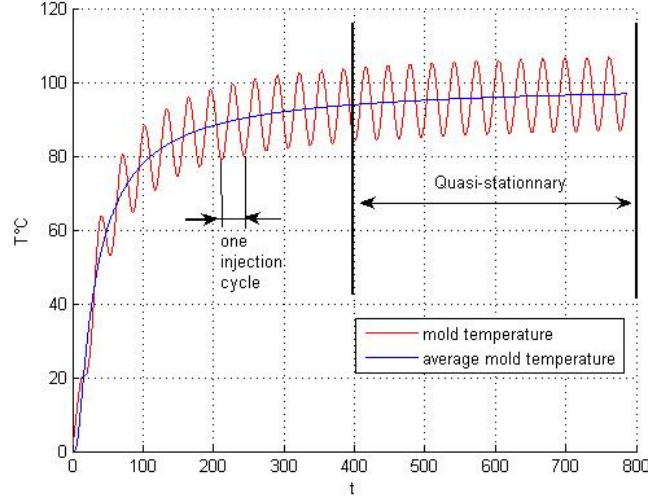

Figure 2: Temperature at the surface of the mold versus time

For a metallic mold, when between 0°C to 200°C , the thermal conductivity can be considered as a constant. Thus, the stationary heat conduction problem reduces to the following Laplace equation:

$$\Delta T = 0,$$

where Δ is the Laplacian operator, T is a temperature vector. Multiplying this equation by a weighting function T^* , and using Green's theorem, we obtain the well-known Somigliana's equation [6]. The following Green integral representation formula gives the value of T in terms of integral equations involving the fundamental solution T^* of the Laplace equation:

$$C.T + \int_{\Gamma} T.(\nabla T^*.n).d\Gamma = \int_{\Gamma} (\nabla T.n).T^*.d\Gamma. \quad (1)$$

Here, n is the unit normal at one element, Γ is the boundary of the domain, C is equal to 1 inside the domain Ω and to 0.5 on its boundary Γ . The weighting function T^* and the flux q^* are the fundamental solutions of the heat-problem, the so-called Green's functions [6]:

$$T^* = \frac{-1}{2.\pi.r} \text{ and } q^* = \frac{-r.n}{4.\pi.r^2}, \quad (2)$$

where r is the distance from the point of application of the concentrated unit source to any other point under consideration. Note that in (1) all the integrals are taken over the boundary of the domain. For the computation of the heat-transfer problem, the contour Γ is discretized and the integrals in the above equation are defined in terms of nodal values by means of interpolation functions. After reorganization of terms in (2) using the boundary conditions, we obtain a non-symmetrical linear system. We shall need to remesh the cooling channel surfaces using 2D elements, and to solve this system of equations at every optimization evaluation.

Figure 3 shows the boundary conditions on the mold.

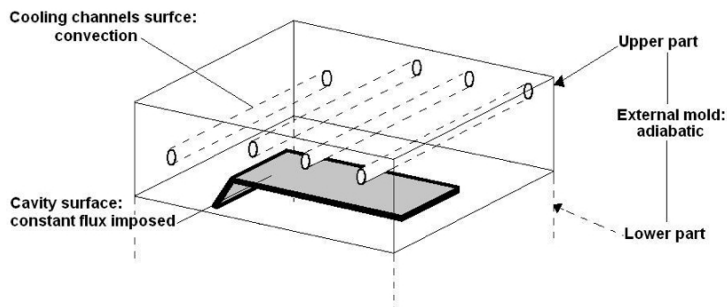

Figure 3: Boundary conditions

We detail the boundary conditions of the heat transfer problem in Figure (3). The following equation relates the temperature of the coolant, T_c , and the heat-transfer coefficient, h , with the coolant flow rate (via Colburn correlation coefficient) [11]:

$$\lambda \cdot q = h(T_a - T_c),$$

where λ is the conductivity, q is the heat flux, and T_a is the ambient temperature. The following polymer properties are referenced in Table 1: ρ is the density and C_p is the heat capacity. The flux density at the cavity surface, ϕ_{cavity} , is computed from the cooling cycle time, $t_{cooling}$, and the polymer properties (heat due to polymer crystallization is neglected) [11]:

$$\phi_{cavity} = \frac{Q}{t_{cooling} \cdot \Gamma_{cavity}},$$

where Q is the heat evacuated by the plastic part during one injection cycle.

	units	polymer (PP)	mold (steel 40cmd8s)
λ	$\text{W m}^{-1} \text{K}^{-1}$	0.63	34
ρ	kg m^{-3}	891	7800
C_p	$\text{J kg}^{-1} \text{K}^{-1}$	2740	460

Table 1: Parameter values for heat-transfer problem

Finally, remark that for our problem, we only need to mesh *once* the cavity surface and the external surface of the mold. Then, each time the optimization algorithm requires to evaluate the objective and the constraint functions, we must mesh the surface of the cooling channels. The output of the heat-transfer problem resolution is a set of temperature measurements, one for each surface element: cavity, external mold surface, and cooling channels. However, we only need the vector T of temperature measurements, $\{T_i(x)\}_{i \in S}$, at the *cavity* surface elements (S denotes the index set of the cavity surface elements).

3 OVERALL OPTIMIZATION METHODOLOGY

We first present in this section how we formulate our problem under a mathematical programming form. Then, we detail our overall computational methodology. In the sequel, x will denote the vector of optimization variables (position and shape parameters for the cooling channels). Since the output of the heat-transfer problem is function of x , we shall make explicit the dependence of the temperature measurements upon the position and shape parameters $x : \{T_i(x)\}_{i \in S}$.

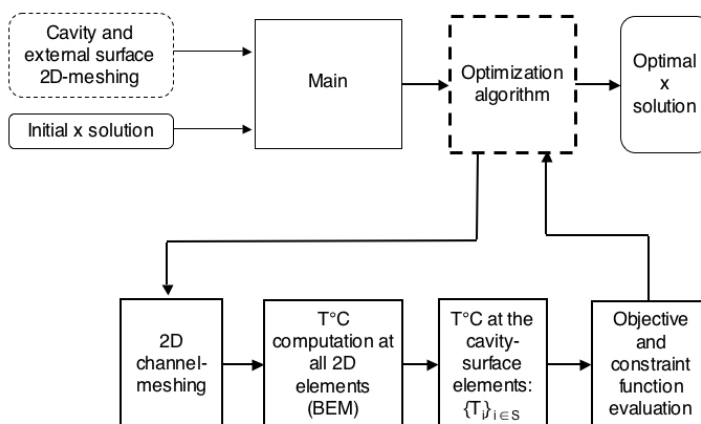

Figure 4: The heat-transfer simulation coupled with the optimization algorithm.

Most practical optimization problems involve several (often contradictory) objective functions. It is the case here as one aims at minimizing the temperature of the plastic-part surface while minimizing the variation of the temperature along this surface. The simplest way to proceed in such a multicriterion context is to consider as objective function a weighted sum of the various criteria, which involves choosing appropriate weighting parameter values (more on multicriterion optimization can be found in [15]). An obvious alternative is to use one criterion as objective function while requiring in constraints maximal threshold levels for the remaining criteria. We choose here the latter approach because in our application context, it is more desirable to consider the temperature requirement as a constraint. Indeed, we do know a threshold level value for the maximal temperature variation under which any variation is equally acceptable. More precisely, we formulate our problem under the form:

$$\min_x \|T(x)\|$$

$$\text{subject to } f(T(x)) \leq 0 \tag{3}$$

$$g(x) \leq 0, \tag{4}$$

where f is a real-valued function used to stipulate the uniformity-temperature constraint, and $g(x)$ is a general vector-valued non-linear function. Remark that $\|\cdot\|$ stands for any norm such as the l_1 norm (sum of absolute values), the standard Euclidean (l_2) norm, or

the $\max(l_\infty)$ norm. The general constraints (4) represent any geometry-related or other industrial constraints, such as:

- upper/lower-bound constraints on the x_i 's,
- keeping the cooling channels within the mold,
- technically-forbidden zones where we cannot position the cooling channels (for instance due to the presence of ejectors),
- constraints stipulating a minimal distance between every pair of cooling channels to avoid inter-channels collision.

Figure 4 shows the coupling between the thermal solver and the optimization algorithm.

4 APPLICATIONS

In this section, we present computational experiments on two semi-industrial plastic parts.

For both applications, we specify the following implementation strategies. We use commercial software for the tasks represented by dashed-line boxes in Figure 4:

- IDEAS for the initial 2D meshing of the cavity and the external surface (note that this meshing remains constant throughout the optimization process),
- Matlab's `fmincon` [9] Sequential Quadratic Programming subroutine for the optimization algorithm (with finite-difference computation of the gradients for these preliminary experiments—in future work, we intend to compute exact gradients).

We programmed every other task (represented by full-line boxes in Figure 4) in Matlab. The system of linear equations involved in the heat-transfer problem is solved by the LAPack [16] subroutine included in Matlab 7.0. We use here the l_∞ (max) norm for the objective function:

$$\|T(x)\|_\infty := \max_{i \in S} T_i(x). \quad (5)$$

All numerical results reported in the sequel are obtained on a Macintosh 1.83 GHz Intel core 2 duo.

4.1 EuroTooling mold with straight cooling channels

For our first application, we consider a semi-industrial injection mold design for the European project: EuroTooling 21 [17]. The plastic part produced from this mold is a bended plate whose dimensions are shown in Figure 5. We want to optimize the position of the cooling channels. The channels are simple straight horizontal cylinders of constant length as illustrated in Figure 6. In order to simplify the presentation, in this application we only optimize the position of the cylinders (we could also consider optimizing the radius of the cross-section of the channels and the number of channels, etc.). As a consequence,

three parameters suffice to describe the position of each cooling channel. For illustration purposes we consider here 8 cooling channels.

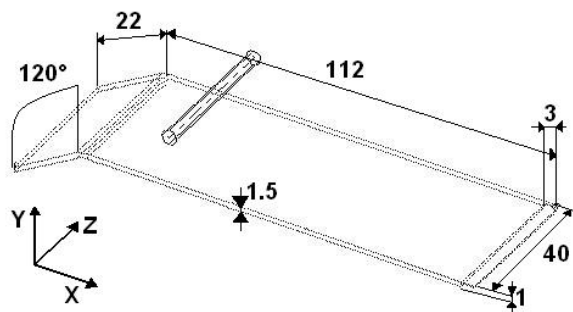

Figure 5: Plastic part dimensions and one cooling channel

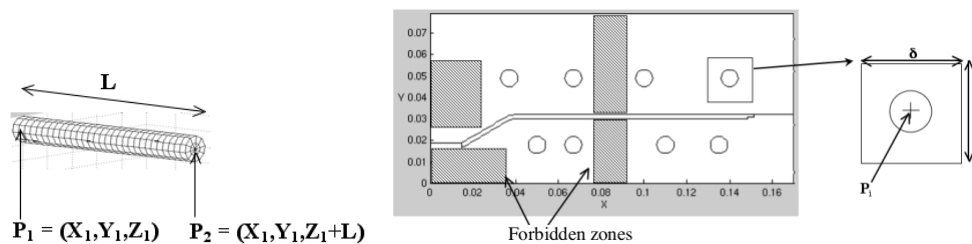

Figure 6: Cooling channel parameters

The components of the optimization vector x are here the coordinates of each end point (X_i, Y_i) , $i = 1 \dots 8$. (in our application Z_i is fixed). Thus, our problem involves 16 optimization variables. For this application, we use the constraint function $F(T(x)) = \|T(x) - \bar{T}(x)\|_\infty - \sigma$, where the difference $T(x) - \bar{T}(x)$ stands here for the vector whose i^{th} component is $T_i(x) - \bar{T}(x)$, $\bar{T}(x) := \frac{1}{|S|} \sum_{i \in S} T_i(x)$ is the average of the T_i 's, and σ is a user-defined temperature uniformity tolerance. We choose here $\sigma = 4^\circ C$. In other words, we do not accept variations of the temperature that are above $4^\circ C$ with respect to the average temperature and this, everywhere on the plastic-part surface. The remaining constraints here simply stipulate lower/upper bounds and also forbid the grey zones displayed on Figure 6.

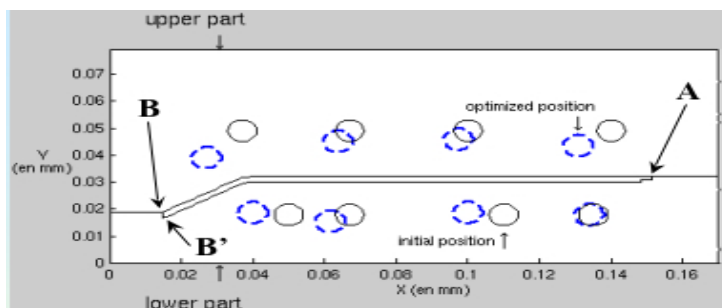

Figure 7: Initial and optimized (dashed lined) positions of the cooling channels

The 2D meshing of the mold surfaces is displayed in Figure 10. The surface of each channel is discretized into 320 quadrangles. We use as starting point, a heuristic solution provided by an experienced engineer. On average, one objective-function evaluation (i.e. the computation of the temperatures) requires 86 seconds of CPU time. Since for these preliminary experiments we are content with computing gradients using finite-difference approximations, one optimization iteration involves 26 minutes of CPU time on average. Figure 7 displays initial (full lines) and optimal (dashed lines) positions of the cooling channels. Figure 8 displays the decrease of the objective-function value in terms of the number of optimization iterations. We observe on Figure 8 that the objective function is reduced by 90% of its initial value within the first four optimization iterations.

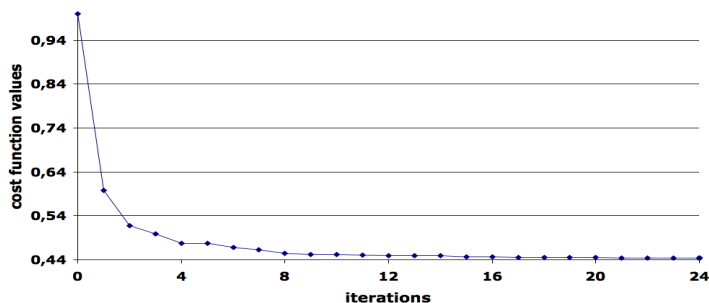

Figure 8: Objective function versus iterations

Figure 9 shows the temperature distribution along the surface of the cavity mold before and after optimization (points A , B and B' refer to positions on Figure 7). We observe that both the temperature variance and the average temperature decreased significantly. The temperature distribution after optimization can be seen on Figure 10

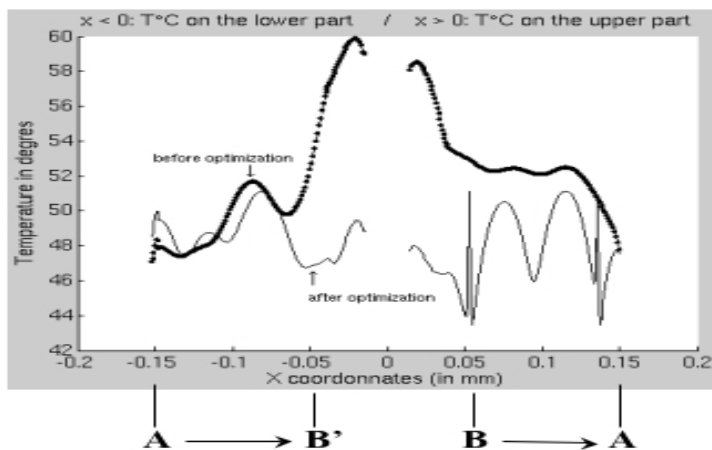

Figure 9: Temperature measurements along the surface of the mold cavity before (black) and after (grey) optimization

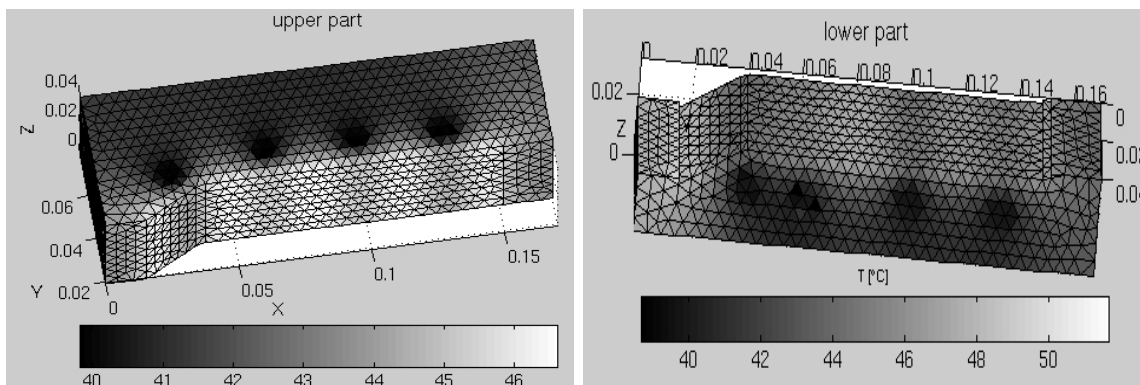

Figure 10: Temperature at the surface of the 3D mold after optimization

4.2 Plastic-cup mold with a helix cooling channel

We now report computational results on a 3D plastic part: a plastic cup. The height of the mold and that of the plastic cup are respectively 12 and 8 cm. The upper radius of the cup is 6 cm, its lower radius is 4 cm, and its thickness is 0.03 cm. In this preliminary study, we are content with considering a helix-shape cooling channel with circular cross section, with only three degrees of freedom: the section diameter of the cooling channel, the frequency of the turn and its overall diameter. The cooling channel is therefore defined in \mathbb{R}^3 using the single parameter algebraic equation:

$$\begin{aligned} X(t) &= r_s \cos t \\ Y(t) &= r_s \sin t \\ Z(t) &= t, \end{aligned} \tag{6}$$

where r_s is the radius of the spiral. We discretize this curve into 63 straight-cylinder channels (Figure 12) with radius r_c . Each of these cylinders is further discretized into

20 quadrangle elements as shown on Figure 13. The 2D meshing of the mold surfaces is displayed in Figure 11

The optimization variables here are:

- the geometrical parameters that control the shape of the helix, that is to say: the radius, r_s of the spiral and the number, n , of helix turns,
- the radius r_c of the circular cross section of the cylinder channels.

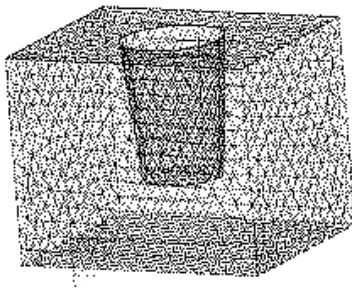

Figure 11: Meshing of the surfaces for the plastic-cup mold

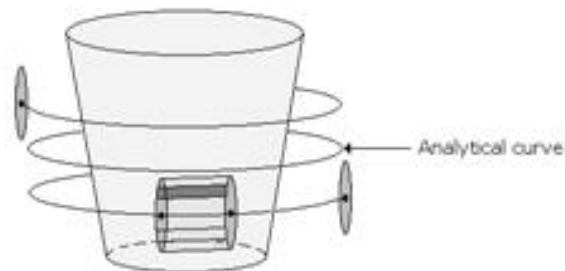

Figure 12: Discretization into straight cylinder channels

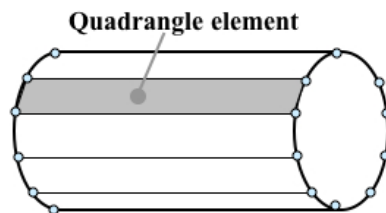

Figure 13: Cooling-channel surface meshing

Our temperature homogeneity constraint here is:

$$\max_{i \in S} T_i(x) - \min_{i \in S} T_i(x) \leq \sigma,$$

with $\sigma = 4^\circ C$. The meshing of the mold surfaces is shown in Figure 12. On average, one objective-function evaluation (temperature computation) requires 82 seconds of CPU time. Again, because of the fact that we compute gradients using finite-difference approximation, one optimization iteration involves, on average, 7 minutes of CPU time. Figure 14 shows the helix curve before and after optimization.

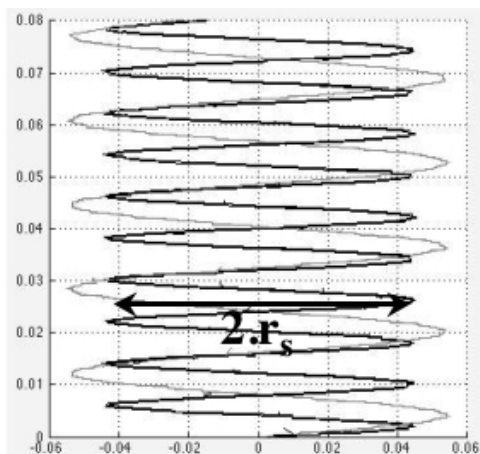

Figure 14: Helix curve before (black) and after (grey) optimization

Figure 15 displays the decrease of the objective-function value in terms of the number of optimization iterations. We observe a rapid convergence during the first five iterations.

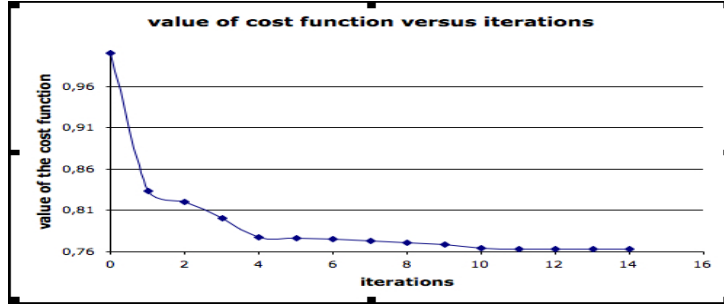

Figure 15: Objective-function value versus iterations

Table 2 displays the initial and optimal solutions, and Figure 16 shows the temperature distribution at the surface of the mold after optimization.

	before optimization	after optimization
r_s (cm)	4.5	5.5
r_c (cm)	0.3	0.1
n	10	5
objective-function value ($^{\circ}\text{C}$)	35°C	28°C
$\max T_i - \min T_i$ ($^{\circ}\text{C}$)	5°C	2°C

Table 2: initial and optimal solutions

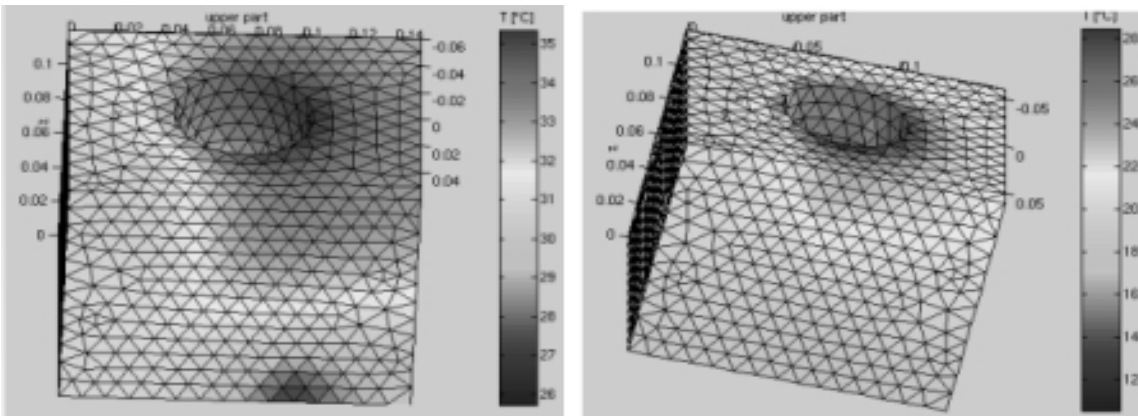

Figure 16: Temperature at the surface of the 3D mold after optimization

5 CONCLUSION

We proposed in this paper a practical methodology to optimize both the position and the shape of the cooling channels in industrial 3D molds. This was made possible through the use of the boundary elements method that avoids full 3D remeshing. Indeed,

only the *surface* of the cooling channels needs to be remeshed to solve the heat-transfer problem involved each time the optimization algorithm needs to evaluate the temperature at the plastic part surface. Our optimization model can account for various ways to address the overall desired low-temperature criterion and the temperature-homogeneity constraint. Encouraging computational experiments on two semi-industrial plastic-parts, demonstrated the viability of our approach that is intended to be used as a decision-analysis tool for designing new, original mold geometries.

We are currently implementing exact gradients to replace finite-difference approximations in order to improve the efficiency of the optimization. Future work could allow more complex shape variations. Recall that we considered in this preliminary study only three degrees of freedom in order to test the viability of our optimization methodology. Other degrees of freedom for our plastic-cup application could for instance include the flux in the cooling channel and a vertical angle so that the helix runs along a cone (closer to the actual cup shape). Finally, further work could formulate our design problem as a topology optimization problem in order to offer even larger design freedom. The wide range of geometries we can tackle for the cooling channels will bring us to address more complex industrial molds. This will undoubtedly yield challenging global optimization problems, as this can be anticipated based on the numerical experiments we reported.

Acknowledgments

This study was conducted within the framework of the European project EuroTooling 21 [17].

References

- [1] Kolossov S., Boillat E., Glardon R., Fischer P. *3D FEM simulation for temperature evolution in the selective laser sintering process*, International Journal of Machine Tools 44, 117-123, 2004. 2
- [2] Polynkin A. *Modeling of cycle 3D heat transfer in injection molding*, International Polymer Processing XIX, 108-418, 2004. 2
- [3] Silva L. In *Parallel computation for solving efficiently 3D viscoelastic fluid flow problems*, International Polymer Processing XX, 265-273, 2005. 2
- [4] Khayat K.E. In *A three-dimensional boundary-element approach to gas-assisted injection molding*, Journal of Non-Newtonian Fluid Mechanics 57, 253-270, 1994. 2
- [5] Katsifarakis K.L. In *Combined use of BEM and genetic algorithms in groundwater flow and mass transport problems*, Engineering Analysis with Boundary elements 23, 555-565, 1999. 2
- [6] Brebbia C., Domiguez J. *Boundary elements: An introductory course*, WIT Press/Computational Mechanics Publication, 1992. 2, 4

-
- [7] Park S.J. *Optimization method for steady conduction in special geometry using a BEM*, International Journal for Numerical Methods in Engineering 43, 1109-1126, 1998. 3
- [8] Mathey E. *Automatic optimization of the cooling of injection mold based on the boundary element method*, NumiForm, 222-227, 2004. 3
- [9] J. Nocedal and S. S. J. Wright *Numerical optimization, springer series in operation research*, Springer, 1999. 3, 7
- [10] I. Catic, A. Abadzic and M. Rujnic-Sokele, *Determining the optimum position of temperature sensors in molds for injection molding of polymers*, Journal of Injection molding Technology, 3(4), 194-200, 1999. 3
- [11] Jui-Ming L. *Multi-objective optimization scheme for quality control in injection molding*, Journal of Injection molding Technology, 6 (4), 2002. 5
- [12] The MathWorks, *User's Guide*, Optimization Toolbox For Use With Matlab, Version 2, 2002.
- [13] Wen-Hsien Y. *Three-dimensional simulation of injection-compression molding of a compact disc*, ANTEC 2001 Conference Proceedings, 2001.
- [14] <http://www.madehow.com/Volume-5/Frisbee.html> 1
- [15] Ehrgott M. *Multicriteria Optimization*, Springer, 2nd ed., 2005. 6
- [16] *LApack*, <http://www.netlib.org/lapack/> 7
- [17] *European project EuroTooling 21*, IP 505901-5, www.eurotooling21.com 7, 14