

Hybrid analytical and integral methods for simulating HTS materials

K. Berger,
L. Quéval, F. Trillaud, G. Escamez,
B. Ramdane, G. Dilasser, H. Menana, J. Lévêque



Why analytical modeling?

- In the design phase, any analytical solution with 80% accuracy is very valuable
- Of course, there are still difficulties in numerical modeling of large scale systems including HTS
- A reference solution is still needed
- We should continue to develop such kind of models

What problems can be solved?

- 2D problems with appropriate boundary conditions

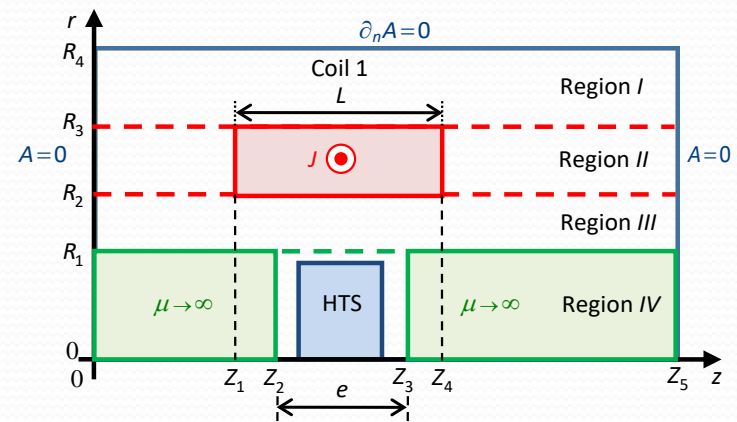
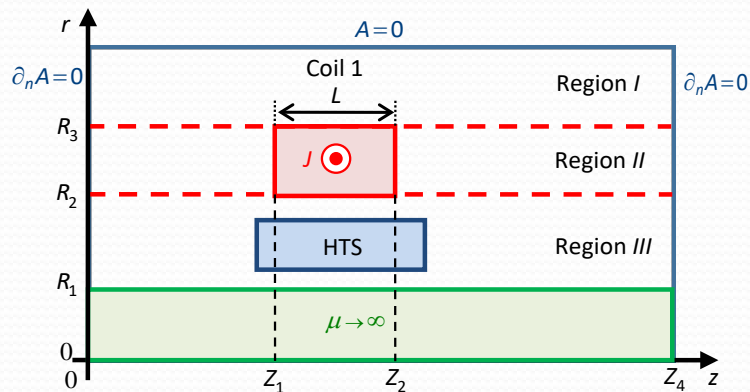
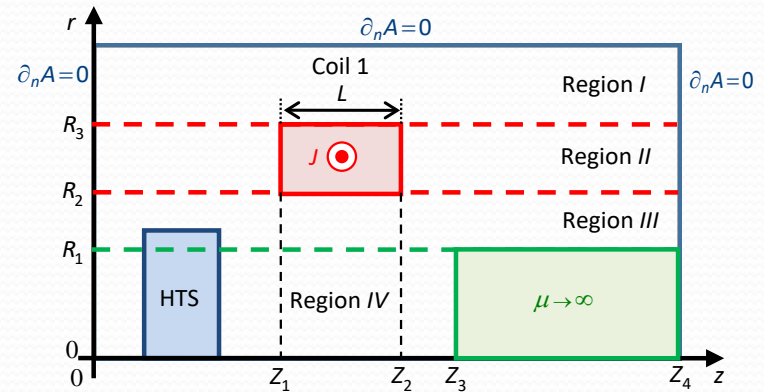
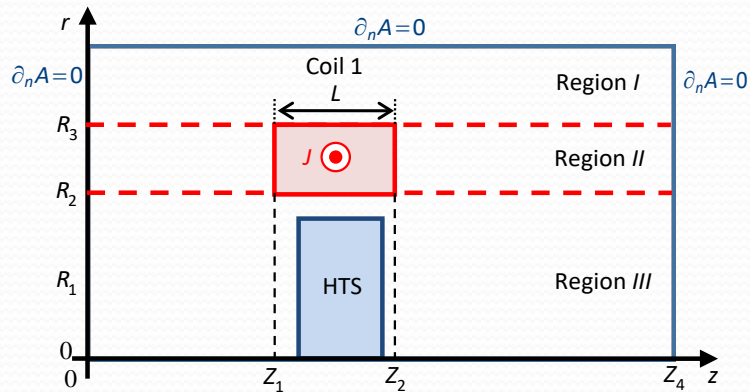

Pulsed Field Magnetization

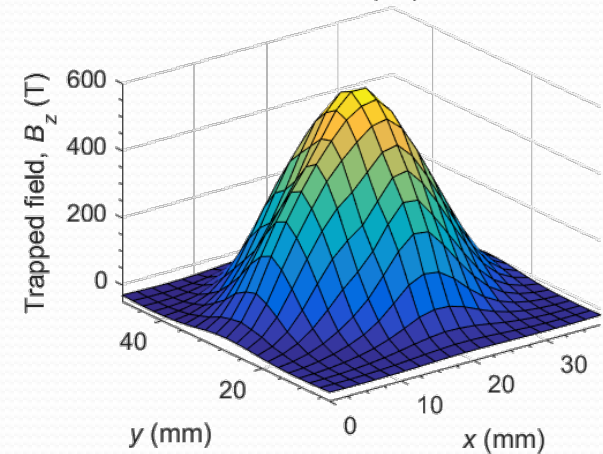
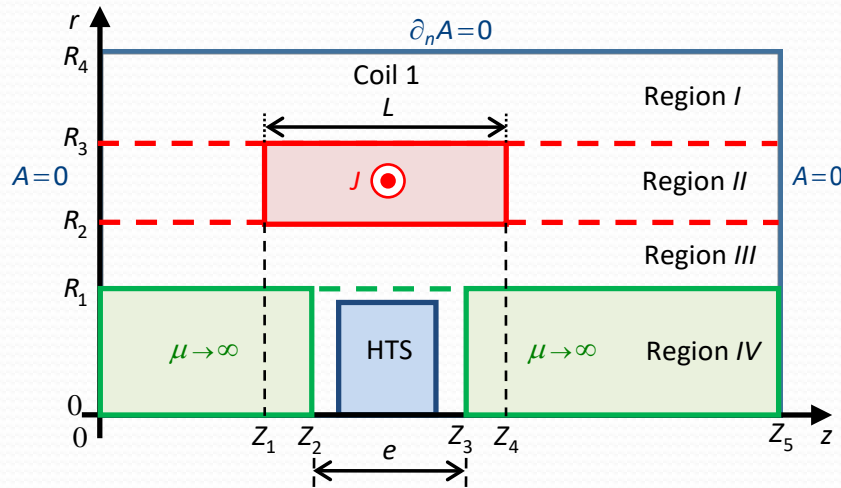
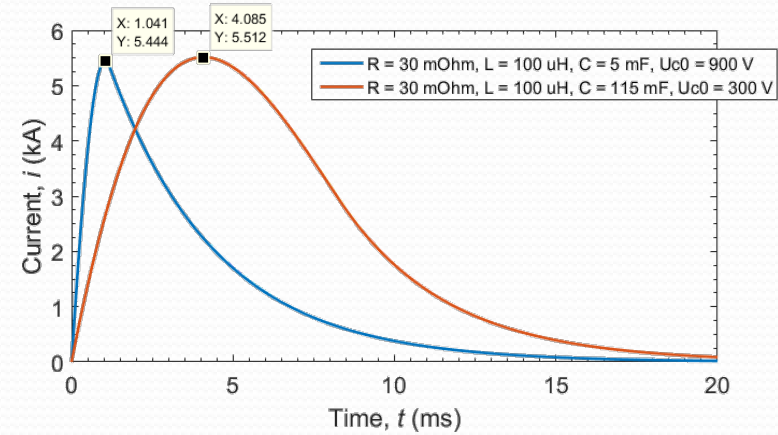
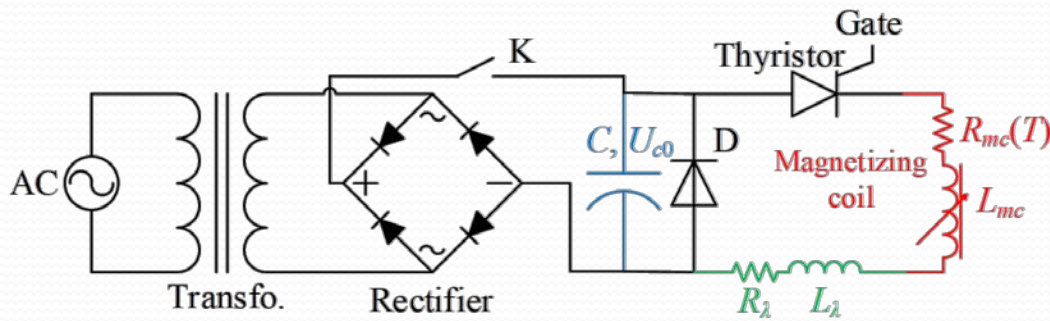

Outline

- Problem description (analytical method)
 - Formulation and assumptions
 - Separation of variables method
 - Inductance calculation
- Brandt's method (integral method)
 - Results of trapped field and induced currents
 - Computing times
- Future work (and collaborations)

Problem description

analytical method

Inductor with magnetic circuit including an airgap

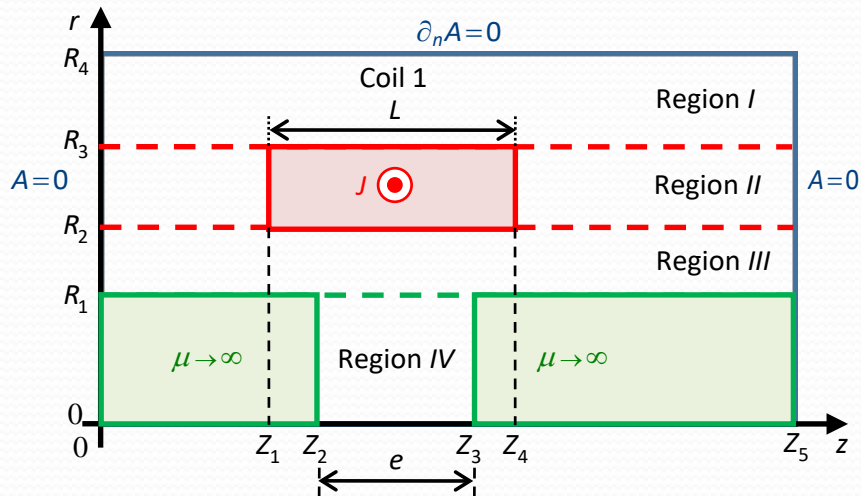

- The coil is fed with a uniform current density J
- Dirichlet and Neuman boundary conditions
- Boundaries are far enough
 $z_1 \gg 0$ and $z_5 \gg z_4$
- HTS bulk will be later placed in the airgap

Formulation and assumptions

- Magnetic vector potential in cylindrical coordinates
- The problem is axisymmetric so $\mathbf{A} = A_\theta(r, z)\mathbf{u}_\theta$
- All materials are assumed magnetically linear
 - Superposition theorem can apply
- From Maxwell's equations with Coulomb gauge

$$\begin{cases} \nabla^2 \mathbf{A}_{II} = -\mu_0 \mathbf{J} & \text{for Region II (coil)} \\ \nabla^2 \mathbf{A}_i = 0 & \text{for Region } i = I, II \text{ and IV} \end{cases}$$

Separation of variables method

from PDE to ODE

- Assuming that the magnetic vector potential is $A(r, z) = R(r)Z(z)$

$$\frac{\partial^2 A}{\partial r^2} + \frac{1}{r} \frac{\partial A}{\partial r} - \frac{A}{r^2} + \frac{\partial^2 A}{\partial z^2} = 0 \Leftrightarrow \frac{R''}{R} + \frac{1}{r} \frac{R'}{R} - \frac{1}{r^2} = -\frac{Z''}{Z} = \alpha^2$$

$$\Rightarrow \begin{cases} Z'' + \alpha^2 Z = 0 \\ r^2 R'' + rR' - (1 + \alpha^2 r^2)R = 0 \quad (\text{modified Bessel equation}) \end{cases}$$

- Each solution must verify the ODE in the considered Region as well as the Boundary Conditions

In Region II (coil)

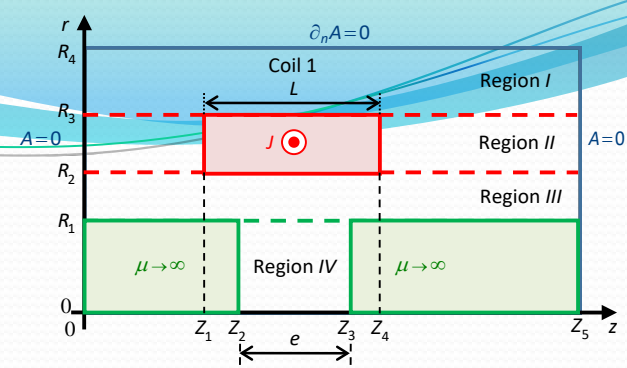

$$\frac{\partial^2 A_{||}}{\partial^2 r} + \frac{1}{r} \frac{\partial A_{||}}{\partial r} - \frac{A_{||}}{r^2} + \frac{\partial^2 A_{||}}{\partial^2 z} = -\mu_0 J(z)$$

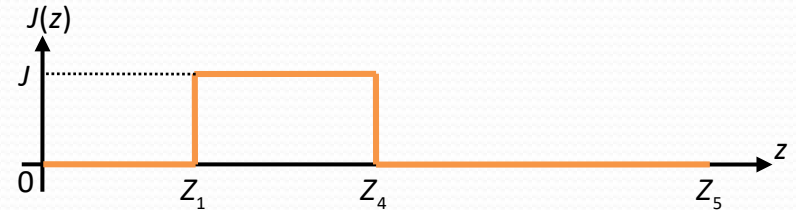

- 1) Looking for the eigenvalues and the eigenfunctions of the homogeneous equation which satisfy the BC

$$Z_{||}(z) = b_{n,z}^{||} \sin(\alpha_n z) \text{ with } \alpha_n = n\pi / Z_5$$

- 2) The source term can be expanded in terms of the eigenfunctions

$$J(z) = \sum_{n=1}^{\infty} J_n \sin(\alpha_n z) \text{ with } J_n = \frac{2J}{n\pi} (\cos(\alpha_n z_1) - \cos(\alpha_n z_4))$$

In Region II (coil)

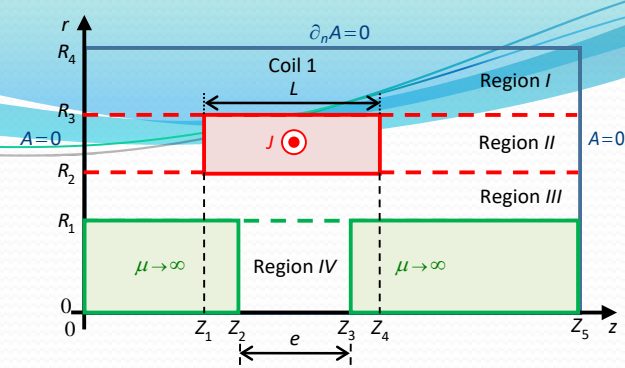

- 3) The general solution requires the solution of a non-homogeneous Bessel's differential equation on the r-variable

$$A_{||}(r, z) = \sum_{n=1}^{\infty} \left(a_n'' I_1(\alpha_n r) + b_n'' K_1(\alpha_n r) - C_n L_1(\alpha_n r) \right) \sin(\alpha_n z) \quad \text{with} \quad C_n = \frac{\mu_0 \pi J_n}{2 \alpha_n^2}$$

- I_1 and K_1 are the modified Bessel functions of the first and second kind and order 1, L_1 is the modified Struve function of order 1
- The integration constants a_n'' , b_n'' have to be determined from interface conditions

In all Regions

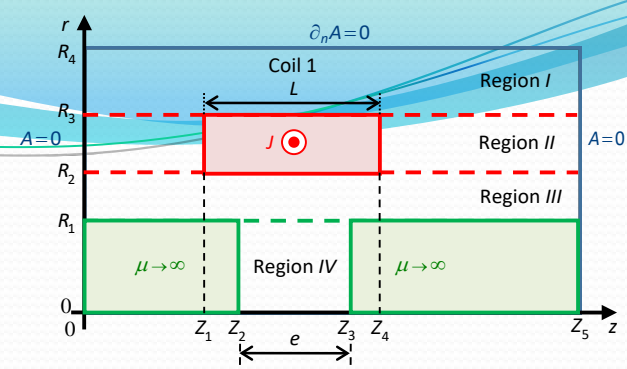

$$A_I(r, z) = \sum_{n=1}^{\infty} b'_n \left(\frac{K_0(\alpha_n R_4)}{I_0(\alpha_n R_4)} I_1(\alpha_n r) + K_1(\alpha_n r) \right) \sin(\alpha_n z) \text{ with } \alpha_n = n\pi / Z_5$$

$$A_{II}(r, z) = \sum_{n=1}^{\infty} \left(a''_n I_1(\alpha_n r) + b''_n K_1(\alpha_n r) - c_n L_1(\alpha_n r) \right) \sin(\alpha_n z)$$

$$A_{III}(r, z) = \sum_{n=1}^{\infty} \left(a'''_n I_1(\alpha_n r) + b'''_n K_1(\alpha_n r) \right) \sin(\alpha_n z)$$

$$A_{IV}(r, z) = A_0 r + \sum_{k=1}^{\infty} a_k^{IV} I_1(\beta_k r) \cos(\beta_k (z - Z_2)) \text{ with } \beta_k = k\pi / (Z_3 - Z_2)$$

$$\text{with } A_0 = \left(R_1 (Z_3 - Z_2) \right)^{-1} \sum_{n=1}^{\infty} \alpha_n^{-1} \left(\begin{array}{l} \left(\cos(\alpha_n Z_2) - \cos(\alpha_n Z_3) \right) \times \\ \left(a'''_n I_1(\alpha_n R_1) + b'''_n K_1(\alpha_n R_1) \right) \end{array} \right)$$

Interface conditions

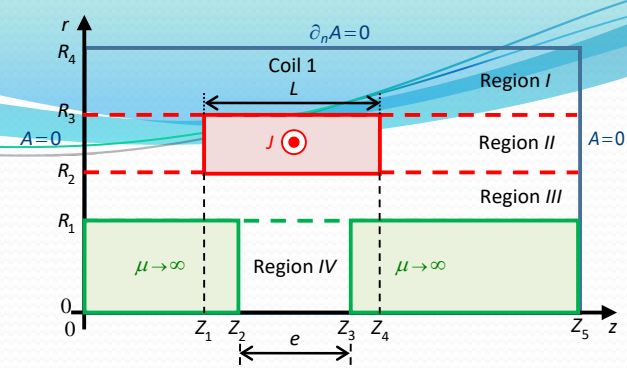

- At $r = R_3$

$$\begin{cases} A_I(r = R_3, z) = A_{II}(r = R_3, z) & \Leftarrow \text{continuity of } A \\ \partial_r (r A_I(r, z)) \Big|_{r=R_3} = \partial_r (r A_{II}(r, z)) \Big|_{r=R_3} & \Leftarrow \text{tangential continuity of } B \end{cases}$$

$$\begin{bmatrix} \eta_{11} & \eta_{12} & \eta_{13} & 0 & 0 & 0 \\ \eta_{21} & \eta_{22} & \eta_{23} & 0 & 0 & 0 \\ 0 & \eta_{32} & \eta_{33} & \eta_{34} & \eta_{35} & 0 \\ 0 & \eta_{42} & \eta_{43} & \eta_{44} & \eta_{45} & 0 \\ 0 & 0 & 0 & \eta_{54} & \eta_{55} & \eta_{56} \\ 0 & 0 & 0 & \eta_{64} & \eta_{65} & \eta_{66} \end{bmatrix} \begin{bmatrix} b'_n \\ a''_n \\ b''_n \\ a'''_n \\ b'''_n \\ a^{IV}_n \end{bmatrix} = \begin{bmatrix} -C_n L_1(\alpha_n R_3) \\ -C_n L_0(\alpha_n R_3) \\ -C_n L_1(\alpha_n R_2) \\ -C_n L_0(\alpha_n R_2) \\ 0 \\ 0 \end{bmatrix}$$

$$\eta_{11} = \frac{K_0(\alpha_n R_4)}{I_0(\alpha_n R_4)} I_1(\alpha_n R_3) + K_1(\alpha_n R_3), \eta_{12} = -I_1(\alpha_n R_3), \eta_{13} = -K_1(\alpha_n R_3) \dots$$

Inductance calculation

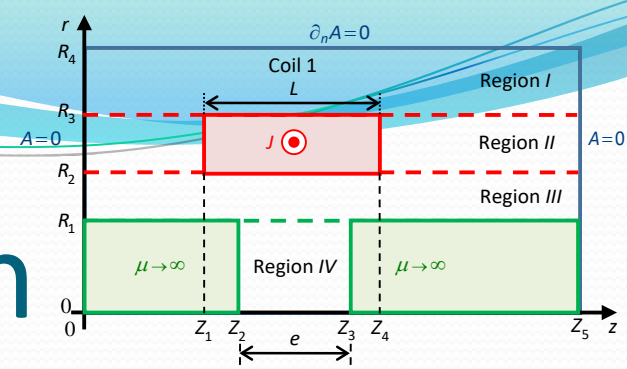

$$\varphi = \frac{2\pi}{S} \int_{z_1}^{z_4} \left(\int_{R_2}^{R_3} A_{||} r dr \right) dz, \quad \Phi = N\varphi = L_{mc} I \quad \text{and} \quad NI = JS$$

$$L_{mc} = 2\pi \frac{N^2}{JS^2} \sum_{n=1}^{N_{\max}} \left\{ \frac{\pi}{2\alpha_n^2} \left(\begin{aligned} & \mathbf{a}_n'' (R_3 U(R_3) - R_2 U(R_2)) \\ & + \mathbf{b}_n'' (R_3 V(R_3) - R_2 V(R_2)) \\ & - \mu_0 J_n \frac{\alpha_n}{6\pi} (R_3^4 W(R_3) - R_2^4 W(R_2)) \end{aligned} \right) \left(\cos(\alpha_n z_1) - \cos(\alpha_n z_4) \right) \right\}$$

$$U(r) = I_1(\alpha_n r) L_0(\alpha_n r) - I_0(\alpha_n r) L_1(\alpha_n r),$$

$$V(r) = K_1(\alpha_n r) L_0(\alpha_n r) + K_0(\alpha_n r) L_1(\alpha_n r),$$

$$W(r) = F \left(\{1, 2\}; \left\{ \frac{3}{2}, \frac{5}{2}, 3 \right\}; \frac{\alpha_n^2 r^2}{4} \right)$$

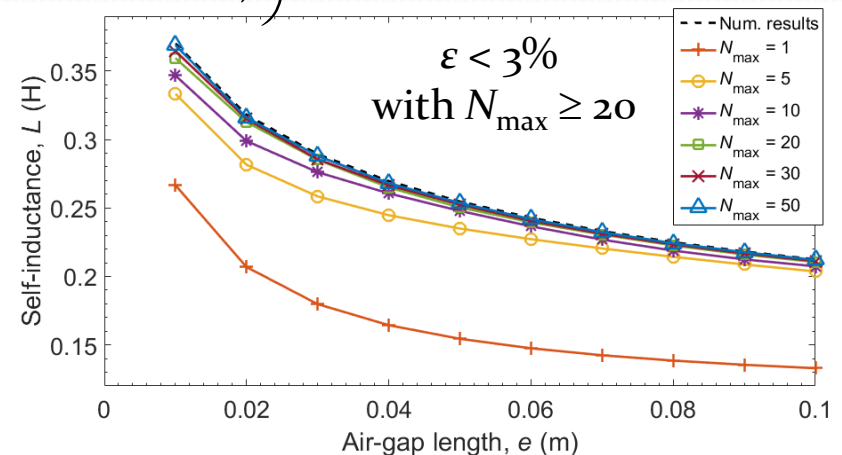

Coupling with Brandt's method

integral method

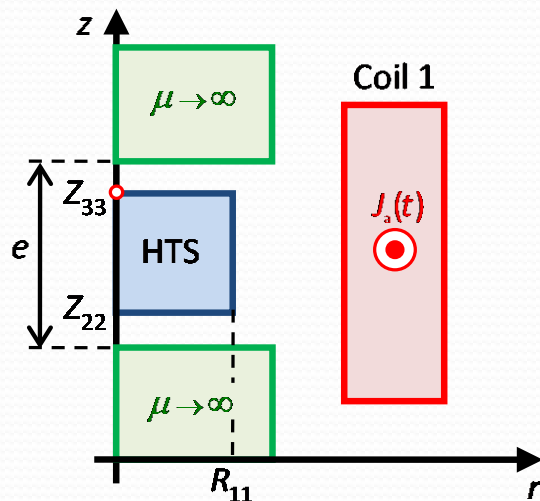

- The magnetic vector potential in the airgap is used as a source term
- The applied current density is now
 - pulsed $J_a(t) = J_{\max} (t / \tau) \exp(1 - (t / \tau))$

$$\frac{dJ(r_2, t)}{dt} = -\mu_0^{-1} \int_0^{R_{11}} \int_{Z_{22}}^{Z_{33}} Q_{\text{cyl}}^{-1}(r_2, r'_2) \left(E(J) + \frac{dA_{IV}(r'_2, t)}{dt} \right) dr' dz' \text{ with } r_2 = (r, z)$$

Coupling with Brandt's method

integral method

$$Q_{\text{cyl}}(r_2, r'_2) = \frac{1}{2\pi} \int_0^\pi \frac{r' \cos \varphi d\varphi}{\left((z - z')^2 + r^2 + r'^2 - 2rr' \cos \varphi \right)^{1/2}}$$

with $\varphi = \arctan(z / r)$

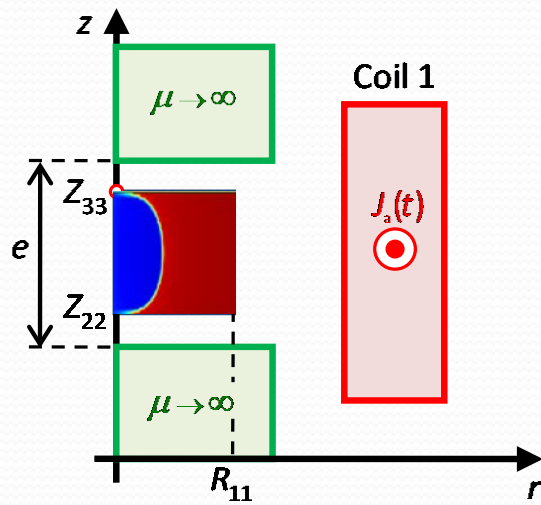

- Q_{cyl} is the kernel obtained by integrating the 3D Green function
- The ferromagnetic material influence is taken into account by means of the method of images

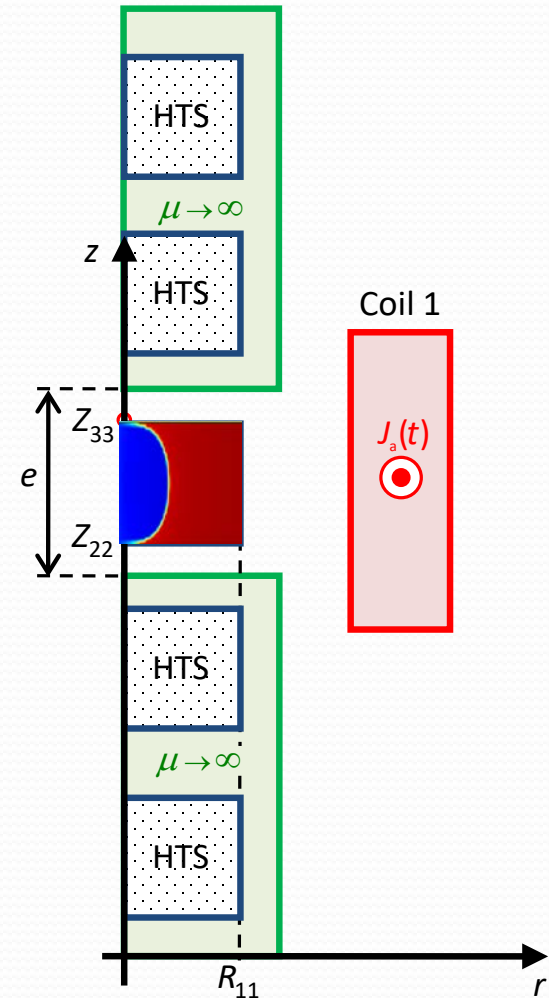

Results

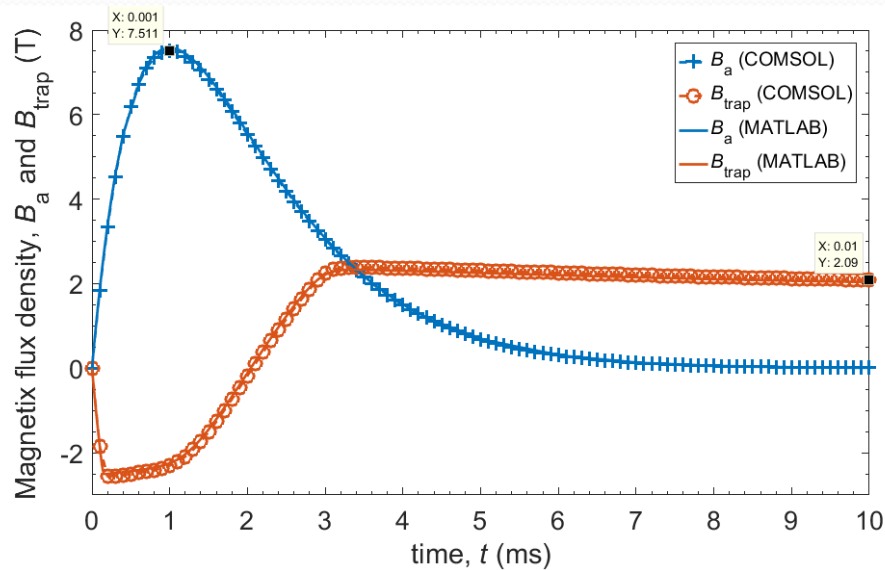

Applied magnetic field B_a and trapped magnetic field B_{trap} on the top surface of the bulk HTS, at $r = 0$ and $z = Z_{33}$.

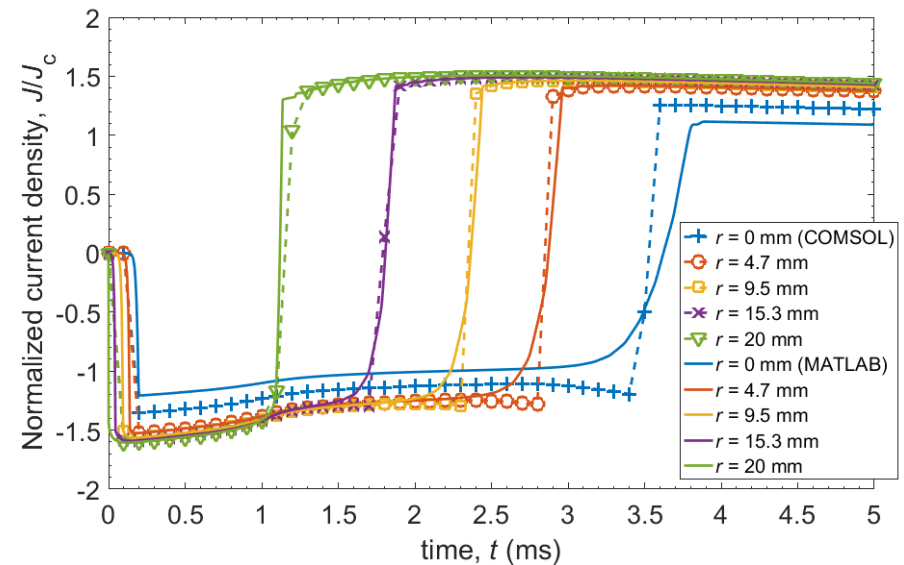

Normalized current density J / J_c in the middle plane of the bulk HTS for $r = \{0, 4.7, 9.5, 15.3, 20\}$ mm.

$$E(J) = (E_c / J_c) (|J| / J_c)^{n-1} J \text{ with } J_c = 100 \text{ A/mm}^2, n = 30, E_c = 1 \text{ } \mu\text{V/cm}$$

Computing times

Intel® Core™ i7-4600 CPU @ 2.10 GHz (Turbo Boost 2.70 GHz), 12 GB RAM (my laptop)

- Analytical calculation
 - < 1 s
- Construction of the topological matrices
 - 75 s
- Solving the system using ode23t (Matlab)
 - 642 s
- COMSOL 5.2a (using PDE)
 - 320 s with linear elements
 - 1896 s with quadratic elements

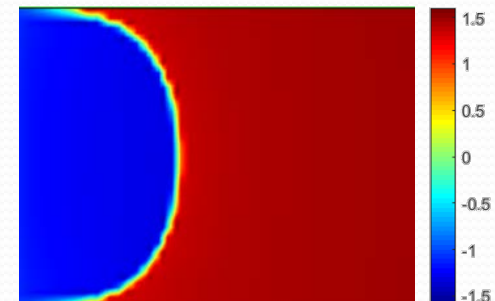
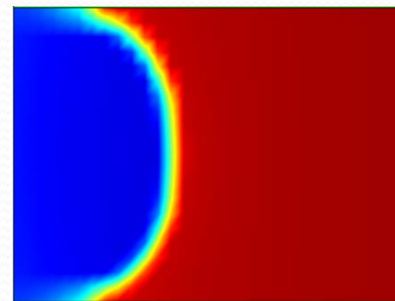
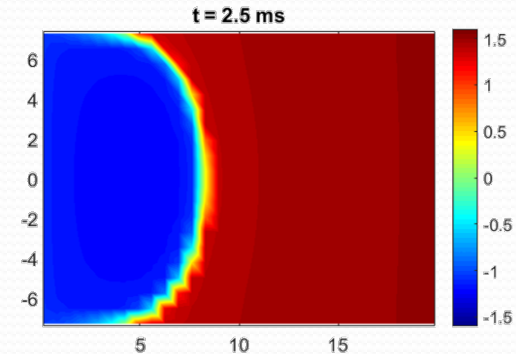

Future work

- Improve matrix conditioning
 - filtering, cut-off...
- Symbolic expression of the coefficients
 - $a'_n, b'_n, a''_n, b''_n, a'''_n, b'''_n$ and a^{IV}_n
- Coupling with thermal equation
 - using finite difference method
- Adaptive mesh refinement
 - with the current density edge
- 3D problems (multiple bulks, magnetic lens...)
 - e.g. with “3D Simulation using the Fast Fourier Transform” from Leonid Prigozhin (<https://arxiv.org/abs/1803.01346>)

The logo features a stylized circular graphic on the left, composed of concentric, overlapping semi-circles in shades of blue, green, and red, resembling a cross-section of a superconductor or a magnetic field distribution. To the right of this graphic, the text "HTS₂₀₁₈ MODELLING" is written in a bold, blue, sans-serif font.

HTS₂₀₁₈ MODELLING

6th International Workshop on
Numerical Modelling
of High Temperature Superconductors

26 - 29 June 2018
Caparica - Portugal

Thank you for your attention!



Dr Kévin Berger
Group of Research in Electrical Engineering of Nancy
University of Lorraine - France

