



HAL
open science

Development of a miniature, fully integrated, multipoint initiation system: CASSIS

Jean-Laurent Pouchaïret, Andres Belisario, Andréa Nicollet, Dominique Medus, Carole Rossi

► To cite this version:

Jean-Laurent Pouchaïret, Andres Belisario, Andréa Nicollet, Dominique Medus, Carole Rossi. Development of a miniature, fully integrated, multipoint initiation system: CASSIS. International Pyrotechnics Society Seminar (IPSUSA 2018), Jul 2018, Fort Collins, United States. 5p. hal-01745515

HAL Id: hal-01745515

<https://hal.science/hal-01745515v1>

Submitted on 19 Jul 2018

HAL is a multi-disciplinary open access archive for the deposit and dissemination of scientific research documents, whether they are published or not. The documents may come from teaching and research institutions in France or abroad, or from public or private research centers.

L'archive ouverte pluridisciplinaire **HAL**, est destinée au dépôt et à la diffusion de documents scientifiques de niveau recherche, publiés ou non, émanant des établissements d'enseignement et de recherche français ou étrangers, des laboratoires publics ou privés.

Development of a miniature, fully integrated, multipoint initiation system: CASSIS

Jean-Laurent Pouchairet^{a,b*}, Andres Belisario^a, Andrea Nicollet^a, Dominique Medus^b, Carole Rossi^a

^a LAAS-CNRS, University of Toulouse, 7 Avenue du colonel Roche, 31077 Toulouse, France

^b ETIENNE LACROIX, Route de Gaudies, 09270 Mazeres, France

ABSTRACT

In the midst of a growing need for standardisation and adaptability in pyrotechnic systems, we hereby present a safe pyrotechnical infrared (IR) flare electronically controllable through an embedded miniature initiation system. The countermeasure consists of three distinct blocks: (1) a controllable pyrotechnical ejection block, made of three independently addressable small-scale ejectors integrated in a one-piece molded interconnected device, (2) a terminal stage comprising a structured IR pyrotechnical loaf coupled with a micro-initiation stage integrating low-energy on-chip addressable nanothermite-based initiators, and (3) a connected, autonomous, STANAG 4187 compliant, electronic sensors, arming and firing block.

INTRODUCTION

The combustion of pyrotechnic compositions is widely used to produce a variety of terminal functions, from thrust to light emission, for applications ranging from aerospace to entertainment. Over the 20th century, the developments in modern chemistry allowed their formulations to improve, leading to wider ranges of energetic densities, sensitivities or combustion temperatures. Essentially, pyrotechnic compositions became more efficient in fulfilling highly specific tasks.

Simultaneously, in order to diversify the functions pyrotechnic systems could perform - to make them controllable, safer and more reliable - they started integrating electronics. Due to the size and integration complexity of electronic components within pyrotechnic systems, this evolution has been limited to large devices, such as warheads.

In the next future, we anticipate that the progress made in micro & nanotechnologies will enable the integration of *intelligence* to centimeter-scale and smaller pyrotechnical systems. In particular, to design new, miniature *smart* systems, pyrotechnic engineers will be able to rely on addressable micro initiators.

In the specific case of flares, *smart* flares, i.e. integrating decision and action capacities, will need to be able to adapt their pyrotechnical effect to efficiently protect different vehicles and deceive various threats.

The present paper details the work realised the past three years in developing a smart, miniature (1''1''8'') IR flare composed of three main functional blocks which are mechanically and electronically interconnected (See Figure 1) : (1) a controllable pyrotechnical ejection block, made of three independently addressable small-scale ejectors, (2) a terminal stage comprising a structured IR pyrotechnical loaf coupled with a low energy and addressable nanothermite-based ignition stage, and (3) a connected, autonomous, STANAG 4187 compliant, electronic sensors, arming and firing block.

In what follows, we present the concepts, prototypes and validation results for each one of our three functional blocs, highlighting the technological innovations as well as the presizing models used.

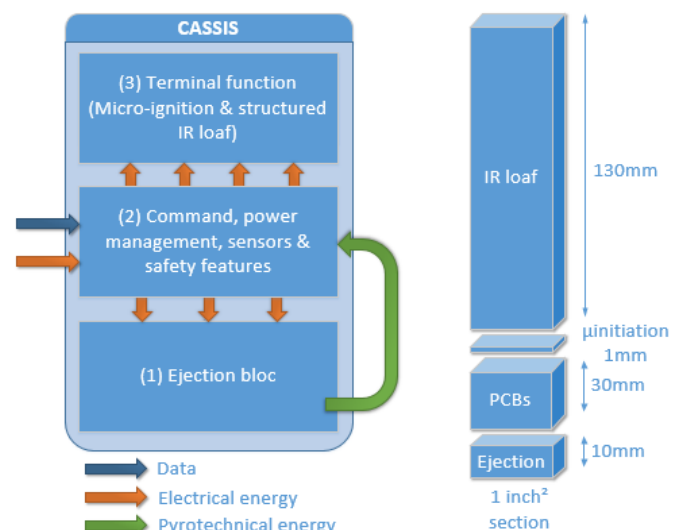

Figure 1. CASSIS – Internal block diagram (left) and corresponding dimensions (right)

CONCEPTION, MODELING AND VALIDATION OF THE EJECTION BLOC

In order to increase the relevance of IR flares in modern warfare, our first objective was to control their tube ejection speed: Since flares are mortar-effect propelled rounds, controlling their ejection speed could allow a single munition to mimic the trajectory of different launching vehicles, or to position itself on the line of sight of different threats.

To this end, we proposed and designed a mortar ejector concept integrating multiple independent ejection charges, the number of charges ignited determining the ejection speed, and relying on *LDS plastronic* technology [1], which allows to metalize 3D plastic parts (see Figure 2.). For demonstration purposes, we chose to restrict our scope of study to three identical charges.

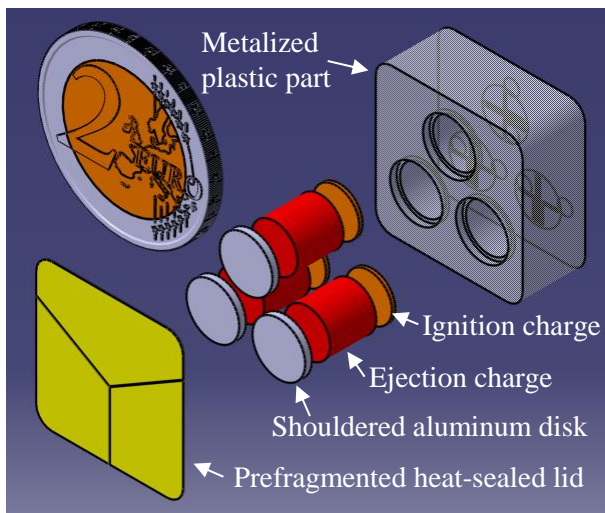

Figure 2. CASSIS – Triple *plastronic* ejector concept

We implemented a STANAG 4367-based lumped parameter internal ballistics model to size the ejection bloc. We conducted a response surface methodology study [2] to extract the conception parameters (combustion & expansion chamber volumes, cartridge stopper & ejector lid unsealing pressures) corresponding to minimal ejection charges for given ejection speeds.

We manufactured 15 prototypes, starting with molding 3 cm^3 plastic parts in which we bored cylindrical chambers. We used a laser beam to activate selected surfaces. We then dipped the parts in metal-oxide baths, metalize hot wires on the bottom of each chamber and communication tracks on the sides of the parts (see Figure 3).



Figure 3. CASSIS – Metalized plastic part prototype

In each chamber, we deposited water-suspended zirconium-potassium perchlorate, acting as an ignition charge, and, after air-drying, added grains of bore-potassium nitrate, acting as an ejection charge. We finally closed each chamber with a shouldered aluminum disk, before hot-sealing a prefragmented aluminized polymer lid on top of the plastic piece, to ensure air – and hot gases – tightness.

Compared to existing copper and glass ejectors, with soldered nichrome hot-wires, *plastronic* ejectors allow for reduced interfacial and assembly complexity. In particular, *plastronic* enables the interfacing of several combustion chambers with electronics in small volumes, therefore allowing for controlled ejection in $1''1''$ flares.

Triple *plastronic* ejector prototypes, were validated, in open air, in closed bomb and in representative firings. They are fully functional, but exhibit higher initiation delays than existing nichrome hot wire based devices (11.2 ms against 5 ms for $5\text{A}/1\Omega$). This could easily improved by reducing the section of the hot wire.

Conception, modeling and validation of the terminal function bloc

Our second objective was to control the IR signal emitted by the combustion of a pyrotechnic loaf, so that a single flare could emulate the IR signature of various vehicles, seen from various angles.

In order to do so, we designed a micro multipoint initiation stage concept, and coupled it to a structured pyrotechnical loaf. More precisely, we coupled addressable $5 \times 2.2\text{ mm}$ on-chip nanothermite-based initiators [3] with initiation composition filled grooves on the sides of a metal-

polymer pyrotechnical loaf whose surfaces were coated with inert epoxy-based resin (see Figure 4.). By inerting the surfaces of the loaf and igniting it sequentially or partially on millimeter-scale ignition points, we meant to ensure the electronically controlled generation of independent combustion fronts, and thus to control the corresponding IR effect. Once again, to restrict the scope of our study, we chose to integrate four initiators, coupled to four grooves, one on each side of a parallelepiped loaf.

To simulate the effect of sequential IR loaf ignition on its combustion, we proposed and implemented a multi-compositional 3D Fast-Marching [4] & Level-Set [5] based solver for combustion (see Figure 4.).

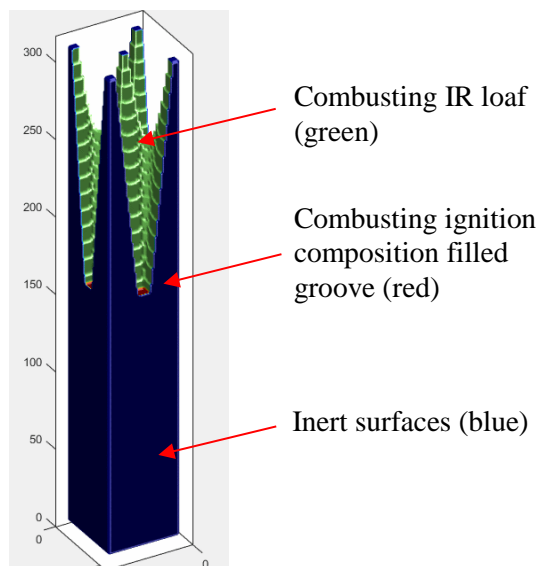

Figure 4. CASSIS – Terminal function concept & model mid combustion – Combustion speed ratio between grooves and loaf of 10:1

We theoretically validated that we should be able to make the rising speed of the IR signal vary from a factor one to four, its duration from a factor one to two and its maximum from a factor one to two, depending on the initiation sequence.

We experimentally validated the ignition of two common initiation compositions on open air (see figure 5). The chips ignite reliably at 0.7 ms for 1 A. The compositions ignite 10 to 300 ms later, depending on their sensitiveness. The ignition delays are equivalent to those observed on existing flares, where hot, pressured gases ignite the initiation compositions.

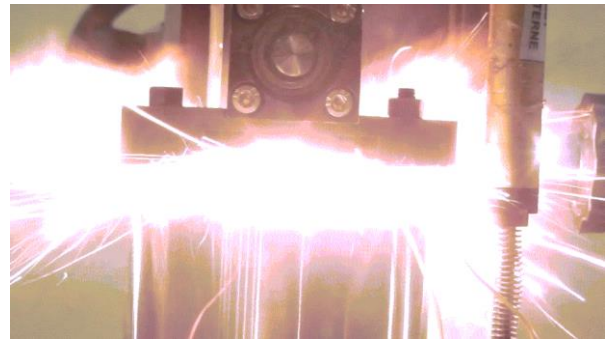

Figure 5. Cassis – Magnesium/Teflon/Viton initiation composition ignited by an on-chip micro-initiator.

Lastly, we experimentally demonstrated the successful sequential generation of four combustion fronts on assembled munitions, on semi-inert loaves loaded with the same compositions (see Figure 6.).



Figure 6. Cassis – Micro-ignition stage & semi-inert pyrotechnical loaf prototype

Until now, the size and energy consumption of existing initiators limited their integration in miniature electro-pyrotechnic systems. Using MEMS nanothermite initiators, no more than 8 mm³ and consuming less than 3 mj to activate, we can integrate a large number of initiators in the same cartridge, allowing to finely tune its terminal effect.

CONCEPTION, MODELING AND VALIDATION OF ELECTRONICS & SAFETY FEATURES

To control the micro initiation stage after ejection and ensure its safety, our smart flare concept integrates its own electronic module. In detail, it can self-test, controls the arming of the flare, the

ignition of the ejectors and the loaf, the detection of ejection through sensors, the communication with the launcher, and manages on-board energy. It spreads over five PCBs.

Regarding safety features, no normative context for intelligent flares has been defined at the moment. We arbitrarily chose to respect the STANAG 4187, destined to warheads, to prove that, given our dimensions constraints, we could comply with any given security requirements.

Our final prototype integrates within less than 25 cm³ a 0.47F SG supercapacitor from Panasonic to store energy, a PIC microcontroller assuring control/command and communication on a CAN bus, and micro-current sources from LinearTech to ignite reproducibly the MEMS initiators. It also integrates a 6050 IMU from InvenSense and a VCNL4040 IR emitter/receptor from Vishay to detect nominal ejection and to trigger arming (see Figure 7.).

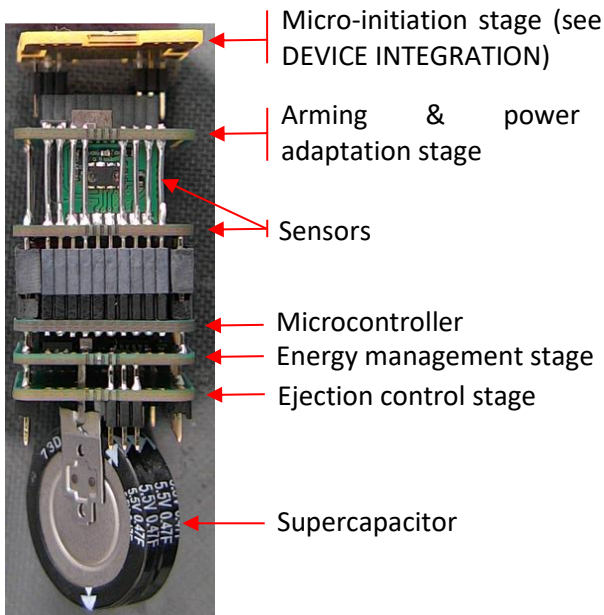

Figure 7. CASSIS – Electronics prototype

We validated the self-test, charge, discharge, arming and ignition routines on tabletop lab experiments.

We developed a mechanical security, compatible with the micro-initiation stage, which rotates all of the electronic and ejection blocs, and validated it on representative 3D printed pieces. It has yet to be further integrated (see Figure 8.).

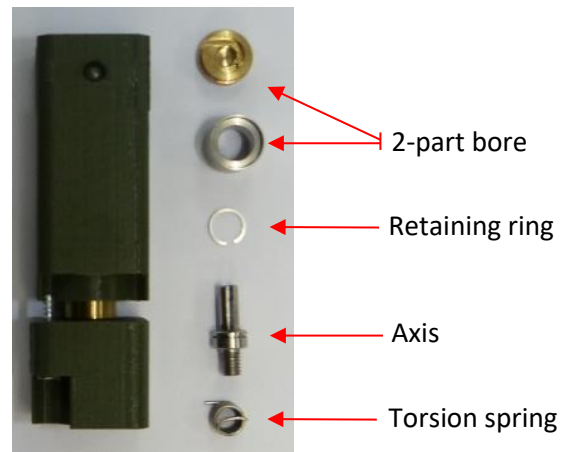

Figure 8. CASSIS – Mechanical safety prototype

DEVICE INTEGRATION

Not to overshadow the advantages offered by the aforementioned technological blocks, we paid careful attention to their interfaces and their integration.

First, in order to ensure backward launcher compatibility, we chose to have energy and data come through the bottom of the cartridge, where the ejection block lies. This implied that conductive tracks had to cross the ejection block before reaching the electronics (see Figure 1.). To foster miniaturization, integration and reliability, we chose to use plastronics to metalize four tracks upon the ejection block, two for CAN communication and two for power transfer.

Second, concerning the MEMS initiators, by nature of PVD deposition, the pads and the thermite nanolayers are on the same side of the chip. Until now, they were interfaced using wire bonding or a trail of conductive adhesive. To handle harsher climatic and mechanic conditions, and to improve integration with electronics, we soldered the chips on PCBs with holes before encapsulating them (see Figure 9.)

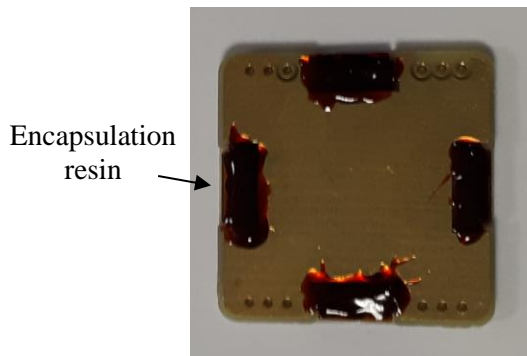
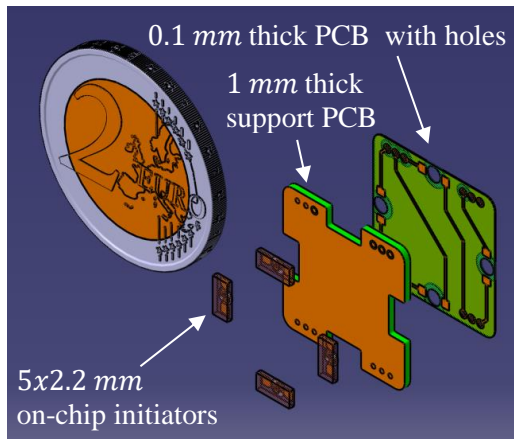

Figure 9. CASSIS – Micro-initiation stage

Lastly, as for the interconnections between the PCBs, we used standard pin headers for their reliability and relatively small size. Note that on Figure 7. We also used bigger, unpluggable male/female headers for debugging purposes.

SUMMARY

We demonstrated the feasibility of a controllable, autonomous, safe & *smart* 1"1"8" IR flare. Within this framework, we developed innovative technological bricks enabling control over the flare ejection velocity and IR effect, using innovative multipoint concepts. More specifically, we developed a plastronic-based triple ejector and a micro-initiation stage powered by a supercapacitor to ignite the IR loaf after the ejection. Using novel initiators and integration techniques was essential to meet ambitious miniaturization and functionalization requirements.

In addition, we developed and validated a miniature, STANAG 4187 compatible electronic module, and the corresponding labview HMI for further use and characterization.

Lastly, beyond technological prototyping, we developed internal ballistics and combustion modelling tools, to be used in future studies.

REFERENCES

- [1] H. Wißbrock, "A New Addition to MID Technologies: Laser Direct Structuring of Plastics," *Kunststoffe Plast Eur.*, vol. 92, no. 11, 2002.
- [2] G. E. P. Box and N. R. Draper, *Response Surfaces, Mixtures, and Ridge Analyses*. Hoboken, NJ, USA: John Wiley & Sons, Inc., 2007.
- [3] A. Nicollet *et al.*, "Investigation of Al/CuO multilayered thermite ignition," *J. Appl. Phys.*, vol. 121, p. 034503, Jan. 2017.
- [4] J. A. Sethian, "A fast marching level set method for monotonically advancing fronts.," *Proc. Natl. Acad. Sci.*, vol. 93, no. 4, pp. 1591–1595, Feb. 1996.
- [5] B. Després and F. Lagoutière, "Contact discontinuity capturing schemes for linear advection and compressible gas dynamics," *J Sci Comput*, vol. 16, pp. 16–479, 2002.