



HAL
open science

Three-dimensional Catalan numbers and product-coproduct prographs

Nicolas Borie

► **To cite this version:**

Nicolas Borie. Three-dimensional Catalan numbers and product-coproduct prographs. FPSAC 2017 The 29th international conference on Formal Power Series and Algebraic Combinatorics, Jul 2017, London, United Kingdom. <hal-01743972>

HAL Id: hal-01743972

<https://hal.science/hal-01743972v1>

Submitted on 26 Mar 2018

HAL is a multi-disciplinary open access archive for the deposit and dissemination of scientific research documents, whether they are published or not. The documents may come from teaching and research institutions in France or abroad, or from public or private research centers.

L'archive ouverte pluridisciplinaire **HAL**, est destinée au dépôt et à la diffusion de documents scientifiques de niveau recherche, publiés ou non, émanant des établissements d'enseignement et de recherche français ou étrangers, des laboratoires publics ou privés.



HAL Authorization

Three-dimensional Catalan numbers and product-coproduct prographs

Nicolas Borie

Université Paris-Est, LIGM (UMR 8049), UPEM, CNRS, ENPC, ESIEE, F-77454, Marne-la-Vallée, France

Abstract. We present the new combinatorial class of product-coproduct prographs which are planar assemblies of two types of operators: products having two inputs and a single output and coproducts having a single input and two outputs. We show that such graphs are enumerated by the 3-dimensional Catalan numbers. We present some combinatorial bijections positioning product-coproduct prographs as key objects to probe families of objects enumerated by the 3-dimensional Catalan numbers.

Keywords: Catalan numbers, Prographs, Bijections, Young tableaux, Up-down permutations, Weighted Dyck paths.

1 Introduction

This story begins with computer explorations. Recall that planar rooted binary trees are planar structures freely generated by a formal operator having one output (a single father per node) and two inputs (left and right children); this single operator can be viewed as a non-associative product. Now, if we add a non-coassociative coproduct with a single input and two outputs, what will be the set of planar structures built from these two formal operators? To bound this problem, we restrict the enumeration to structures having globally a single input and a single output, thus each enumerated element will contain as many products as coproducts.

Such an element is called a *prograph* with one input and one output.

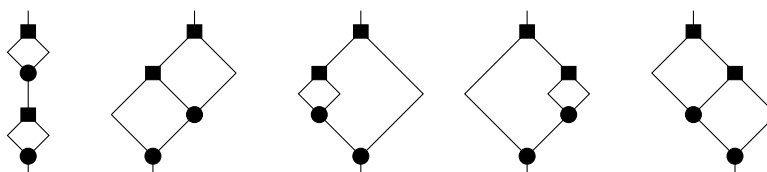

Figure 1: The five prographs with two coproducts, two products, and having a single input and a single output.

We implemented a Sage [2] program enumerating prographs with n products and n coproducts and the first values were 1, 1, 5, 42, 462, 6006, 87516. This is the beginning of Sequence A005789 of the OEIS [8], the 3-dimensional Catalan numbers. **Figure 1** displays the 5 prographs containing two coproducts (circles) and two products (squares). We will see how one can show that prographs containing n products and coproducts are counted by the n^{th} 3-dimensional Catalan numbers. Moreover, we will show that prographs are relevant structures on which a lot of combinatorics can be expressed.

In this paper, we present four combinatorial classes enumerated by the 3-dimensional Catalan numbers and we show how their combinatorics are related to product-coproduct prographs. In the following section, we recall the definitions and some properties of 3-dimensional Catalan numbers, standard Young tableaux with three rows and product-coproduct prographs. In **Section 3**, we present a well-chosen labeling of edges of prographs which can be extended to an isomorphism of Hopf algebras. **Section 4** presents up-down permutations of even size that avoid the pattern (1234). Trying to establish another combinatorial bijection with prographs, we also present in the same section a bijection between permutations avoiding (123) and binary trees (to the best of our knowledge, this bijection is not present in the literature). Finally, in **Section 5**, we show that a labeling of operators of prographs gives another Hopf isomorphism with weighted Dyck paths having some constraints; such paths are also Laguerre histories. This will allow us to build a partial combinatorial bijection between prographs and up-down permutations of even size that avoid the pattern (1234).

2 Preliminaries

Definition 2.1. For n a non-negative integer, the n^{th} 3-dimensional Catalan number counts the number of paths from $(0,0,0)$ to (n,n,n) using steps $(+1,0,0)$, $(0,+1,0)$ and $(0,0,+1)$ such that each point (x,y,z) on the path satisfies $x \geq y \geq z$.

It is obvious that the n^{th} 3-dimensional Catalan number also counts the number of standard tableaux of shape (n,n,n) : from a 3-dimensional path, read from left to right, assign a number from 1 to $3n$ to each step and fill the tableau by inserting labels of step $(+1,0,0)$ on the first row, $(0,+1,0)$ on the second row and $(0,0,+1)$ on the third row. The following example uses the French convention for tableaux.

$$\begin{array}{cccccccc}
 (0,0,0) & \rightarrow & (1,0,0) & \rightarrow & (1,1,0) & \rightarrow & (2,1,0) & \rightarrow & (2,1,1) & \rightarrow & (2,2,1) & \rightarrow & (2,2,2) & \begin{array}{|c|c|} \hline 4 & 6 \\ \hline 2 & 5 \\ \hline 1 & 3 \\ \hline \end{array} \\
 + (1,0,0) & & + (0,1,0) & & + (1,0,0) & & + (0,0,1) & & + (0,1,0) & & + (0,0,1) & & & (2.1) \\
 1 & & 2 & & 3 & & 4 & & 5 & & 6 & & &
 \end{array}$$

We denote by $ST_{\langle n^3 \rangle}$ the set of standard Young tableaux of shape (n,n,n) . The hook-length formula for standard tableaux gives the following nice expression.

Proposition 2.2. *The n^{th} 3-dimensional Catalan number $C_n^{(3)}$ is given by:*

$$|ST_{\langle n^3 \rangle}| = \frac{2 \cdot (3n)!}{n! \cdot (n+1)! \cdot (n+2)!}. \quad (2.2)$$

Although it is complicated to describe in general, the Schützenberger involution of rectangular standard Young tableaux can be obtained with an easy algorithm.

Proposition 2.3 (See [9, 7] for details). *The Schützenberger involution S has a simple description on rectangular standard Young tableaux: it consists in reversing the alphabet $\{1, 2, \dots, n\}$ and rotating the tableaux by 180° .*

Formalized by category theory [6], PROs are often viewed as the natural generalization of operads. These are still planar assemblies of formal operators, but now, formal operators have not necessarily a single output. The product over objects remains grafting, however objects are not trees anymore but graphs.

Free PROs over a finite set of generators constitute a nice example of PRO to apprehend this object. Given a finite set of operators G , the free PRO generated by G is the set of all finite planar graphs (called *prographs*) freely built using elements in G (each operator can appear several times). As “free” means also formal, a generator inside G can just be described by its number of inputs and outputs.

Definition 2.4. *A product-coproduct prograph is a connected directed graph having a single input and a single output and composed with two types of nodes: coproduct nodes having a single input and two outputs and product nodes having two inputs and a single output.*

As each coproduct introduces a new output and each product suppresses an output, a product-coproduct prograph must contain as many products as coproducts. For n a non-negative integer, we will denote by $PC(n)$ the set of product coproduct prographs containing n coproducts and n products.

Let V be a formal module, let $\Delta : V \rightarrow V \otimes V$ be a coproduct and $\cdot : V \otimes V \rightarrow V$ a product. Encoding the operator \blacktriangledown having a single entry and two outputs with Δ and encoding \blacktriangleleft with the product \cdot , we can associate an algebraic expression with each prograph. The associated expression models a map from V to V and is a composition of layers which are mainly tensor products of some Δ , \cdot and the identity map Id . Without any operator, the only product-coproduct prograph is the unique empty prograph. Doing nothing (or do not change anything) corresponds to the map Id .

There is a single prograph with one coproduct and one product: $\cdot \circ \Delta$.

With two coproducts and two products, we get the five following expressions associated with the five prographs of [Figure 1](#) from left to right:

$$\begin{aligned} \cdot \circ \Delta \circ \cdot \circ \Delta, & \quad \cdot \circ (\cdot \otimes Id) \circ (Id \otimes \Delta) \circ \Delta, & \quad \cdot \circ (\cdot \otimes Id) \circ (\Delta \otimes Id) \circ \Delta, \\ \cdot \circ (Id \otimes \cdot) \circ (Id \otimes \Delta) \circ \Delta, & \quad \cdot \circ (Id \otimes \cdot) \circ (\Delta \otimes Id) \circ \Delta. \end{aligned} \quad (2.3)$$

Definition 2.5. Rotating by 180° naturally defines an involution S on prographs which we will call the Schützenberger involution.

We will see in [Proposition 3.2](#) that it is equivalent to the classical Schützenberger involution, hence the name.

The example of [Figure 2](#) is a little bigger one with seven layers on the graph, and thus, the expression describing the product coproduct prograph has seven blocks of operators.

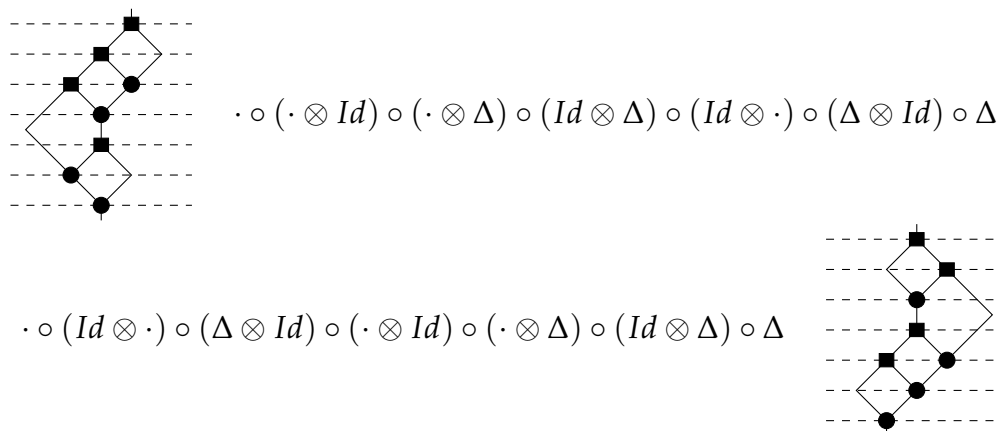

Figure 2: A prograph, its image by the Schützenberger involution and their algebraic expressions.

Reading the expression from left to right (respectively from right to left) corresponds to scanning the prograph from top to bottom (respectively from bottom to top). On the algebraic expression, the Schützenberger involution consists in switching coproducts Δ and products \cdot , and reversing the obtained expression.

As our product-coproduct prographs have a single input and a single output, we can assemble prographs by stacking them: the output of the first one grafted with the input of the second one. This operation defines a product making the disjoint union $PC := \bigcup_{n \in \mathbb{N}} PC(n)$ a monoid. The algebra of this monoid, coupled with the proper coproduct, turns out to be a Hopf algebra.

3 Labeling edges of product-coproduct prographs

A well-chosen labeling of the edges of prographs gives a first bijection, which strongly motivated our investigations on these objects.

Theorem 3.1. The set $PC(n)$ of product-coproduct prographs of size n has as cardinality the n^{th} 3-dimensional Catalan number.

Proof. We build a bijection le (labeling edges)

$$le : \bigcup_{n \in \mathbb{N}} PC(n) \rightarrow \bigcup_{n \in \mathbb{N}} ST_{\langle n^3 \rangle}$$

and its inverse using a depth-left first search numbering of wires on prographs (See **Figure 3**). The first row of the tableau will contain the labels of the inputs of coproducts, the second row will contain the left inputs of products, and the third row will contains right inputs. \square

Proposition 3.2. *The bijection le preserves the Schützenberger involution. That is, we have:*

$$S(p) = le^{-1}(S(le(p))).$$

Proof. The depth-left first labeling forms a covering path from bottom to top of the prograph (with indices from 1 to $3n$). On the rotated version, we take the same path in its reverse way, labeling with i instead $3n - i$. \square

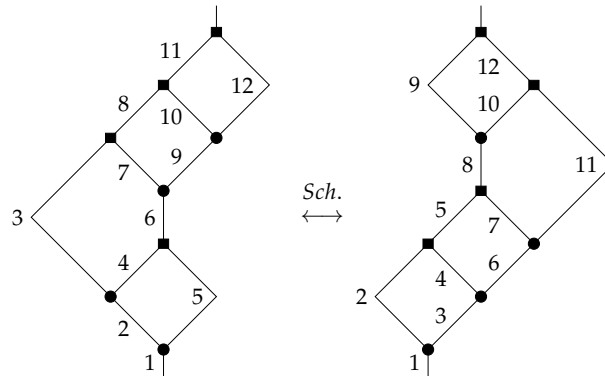

Figure 3: Labeling of the edges of a prograph and its rotated version.

The filling of Young tableaux of prographs of **Figure 3** and the Schützenberger involution give

$$\begin{array}{|c|c|c|c|} \hline 5 & 7 & 10 & 12 \\ \hline 3 & 4 & 8 & 11 \\ \hline 1 & 2 & 6 & 9 \\ \hline \end{array}
 \begin{array}{l} \text{reverse} \\ \text{alphabet} \\ \rightarrow \end{array}
 \begin{array}{|c|c|c|c|} \hline 8 & 6 & 3 & 1 \\ \hline 10 & 9 & 5 & 2 \\ \hline 12 & 11 & 7 & 4 \\ \hline \end{array}
 \begin{array}{l} \text{rotation} \\ \text{by } 180^\circ \\ \rightarrow \end{array}
 \begin{array}{|c|c|c|c|} \hline 4 & 7 & 11 & 12 \\ \hline 2 & 5 & 9 & 10 \\ \hline 1 & 3 & 6 & 8 \\ \hline \end{array} . \quad (3.1)$$

The shifted concatenation product \bullet gives a monoid structure over three-row standard Young tableaux. For instance,

$$\begin{array}{|c|c|c|} \hline 5 & 8 & 9 \\ \hline 3 & 4 & 7 \\ \hline 1 & 2 & 6 \\ \hline \end{array}
 \bullet
 \begin{array}{|c|c|} \hline 5 & 6 \\ \hline 2 & 4 \\ \hline 1 & 3 \\ \hline \end{array}
 =
 \begin{array}{|c|c|c|c|c|} \hline 5 & 8 & 9 & 14 & 15 \\ \hline 3 & 4 & 7 & 11 & 13 \\ \hline 1 & 2 & 6 & 10 & 12 \\ \hline \end{array} . \quad (3.2)$$

Proposition 3.3. *For \mathbb{K} a field, the bijection le extended by linearity on the monoid algebra $\mathbb{K}[\bigcup_{n \in \mathbb{N}} PC(n)]$ with values inside the monoid algebra $\mathbb{K}[\bigcup_{n \in \mathbb{N}} ST_{\langle n^3 \rangle}]$ becomes an isomorphism of graded Hopf algebras.*

4 Up-down permutations of $2n$ avoiding (1234)

An up-down permutation of $2n$ avoiding (1234) is a permutation of size $2n$ whose descents set is $\{2, 4, 6, \dots\}$ with no four letters that form an increasing subsequence. We denote by $A_{2n}(1234)$ the set formed by all these permutations.

Here are the 42 up-down permutations of size 6 avoiding (1234):

$$A_6(1234) = \left\{ \begin{array}{l} 563412, 562413, 562314, 561423, 561324, 463512, 462513, \\ 462315, 461523, 461325, 453612, 452613, 452316, 451623, \\ 451326, 364512, 362514, 362415, 361524, 361425, 354612, \\ 352614, 352416, 351624, 351426, 342615, 341625, 264513, \\ 263514, 261534, 261435, 254613, 253614, 251634, 251436, \\ 243615, 241635, 164523, 163524, 154623, 153624, 143625 \end{array} \right\}. \quad (4.1)$$

Lewis proved that the n^{th} 3-dimensional Catalan numbers count the cardinality of $A_{2n}(1234)$ and gives in [4, 5] two bijections between up-down permutations of $2n$ avoiding (1234) and standard Young tableaux of shape (n, n, n) . However, using these two bijections, we did not manage to prove that up-down permutations of $2n$ avoiding (1234) deploy the same combinatorics as standard Young tableaux or prographs. At first glance, these results appear to us mainly as counting results.

On permutations, we also have the classical Schützenberger involution (and we will once more denote it by S) which consists in reversing the alphabet, then reversing the reading direction. For example, $S(631278594) = 615238974$. As the Schützenberger involution preserves appearance and avoidance of patterns, S stabilizes the set of up-down permutations of $2n$ avoiding (1234).

Definition 4.1. *We define a shifted concatenation product \bullet on $\bigcup_{n \in \mathbb{N}} A_{2n}(1234)$ as*

$$\begin{array}{ccc} \bigcup_{n \in \mathbb{N}} A_{2n}(1234) & \otimes & \bigcup_{n \in \mathbb{N}} A_{2n}(1234) & \longrightarrow & \bigcup_{n \in \mathbb{N}} A_{2n}(1234) \\ \left(\sigma \right) & , & \left(\tau \right) & \longmapsto & \left(\text{shift}_{\text{length}(\sigma)}(\tau) \right) \cdot \sigma \end{array} \quad (4.2)$$

Here are some examples:

$$\begin{aligned} 12 \bullet 12 &= 3412, \\ 2143 \bullet 1324 &= 57682143, \\ 12 \bullet^n &= (2n-1)(2n)(2n-3)(2n-2) \cdots 563412. \end{aligned} \quad (4.3)$$

Not only having the same cardinality, we think that up-down permutations avoiding (1234) present the same combinatorics as prographs. This is formulated in the following conjecture.

Conjecture 4.2. *There exists a bijection between up-down permutations of $2n$ avoiding (1234) and prographs of $PC(n)$ preserving the Schützenberger involution that can be extended to an isomorphism of Hopf algebras.*

For σ an up-down permutation of $2n$ avoiding (1234), we will denote by $Peaks(\sigma)$ the subsequence of values at even positions and $Vals(\sigma)$ the subsequence of values at odd positions inside σ .

Proposition 4.3. *For n a non-negative integer and σ a permutation of size $2n$, σ is an up-down permutation of $2n$ avoiding (1234) if and only if the following four conditions are verified:*

- *the sequence $Peaks(\sigma)$ avoids (123), and*
- *the sequence $Vals(\sigma)$ avoids (123), and*
- *each value of $Peaks(\sigma)$ lower than a valley k appears to the right of k in σ , and*
- *if a valley k has a lower valley to its left, all peak values greater than k to its right must be ordered in σ decreasingly.*

Proof. By exhaustion of all possible positions of values that would form a 1234 pattern. □

Proposition 4.3 gathers conditions not very handy for describing up-down permutations of $2n$ avoiding (1234). However, since permutations avoiding (123) are counted by (classical) Catalan numbers and thus, are in bijection with binary trees, this proposition presents the remaining conditions we will need to build special product-coproduct prographs from a pair of binary trees (the second being reversed over the first one).

Let us now build a bijection between binary trees and permutations avoiding (123) compatible with the depth-left labeling algorithm. Let σ be a permutation of size $n - 1$ avoiding (123). The possible positions of a new value n to be inserted in σ such that it still avoids (123) are constrained. Let τ the maximal prefix of σ whose values are decreasing. If σ begins by a rise, τ contains only the first value of σ . If σ is entirely decreasing, then $\tau = \sigma$. The possible positions to insert n in σ are before τ , just after τ or inside τ . By inserting n farther, we would get a new permutation $\tau\sigma_1n\sigma_2$ where $\tau\sigma_1\sigma_2 = \sigma$ and $\sigma_1 \neq \epsilon$. Such a permutation would contain for sure a pattern (123) where the smallest value can be in τ , the middle one in σ_1 and the value n for the greatest one. At each insertion of the largest value, the number of values after the first rise (or zero if the permutation is entirely decreasing) is a non-decreasing statistic bounded by the size of the permutation minus one. This gives a way to identify a permutation avoiding

1 (0)	①	21 (0,0)		321 (0,0,0)	
3241 (0,0,0,2)		53241 (0,0,0,2,2)		532641 (0,0,0,2,2,3)	
5732641 (0,0,0,2,2,3,6)		58732641 (0,0,0,2,2,3,6,7)		958732641 (0,0,0,2,2,3,6,7,7)	

Figure 4: Insertion algorithms for permutations avoiding (123), non-decreasing parking functions and binary trees labeled by depth-left first traversal.

(123) with a non-decreasing parking function (we mean here a non-decreasing function from $\{1, \dots, n\}$ to $\{0, \dots, n-1\}$ such that $f(i) \leq i-1$).

On the other side, when one labels a planar tree (drawn from bottom to top) from the root with a depth-left first algorithm, at each insertion (or new label), the number of insertion positions left free on the left is non-decreasing and bounded by the number of nodes, and therefore, forms a non-decreasing parking function. The construction of the tree associated with the permutation 958732641 is presented [Figure 4](#).

[Figure 5](#) presents our bijection between the 14 permutations of size 4 avoiding (123) and the 14 binary trees having 4 nodes.

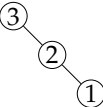
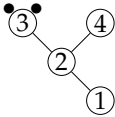
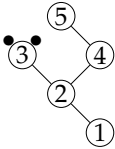
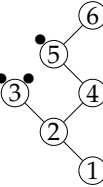
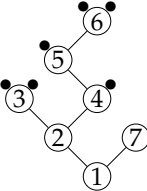
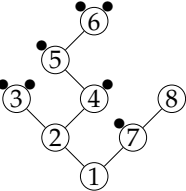
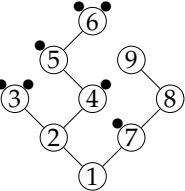
5 Labeling boxes of product-coproduct prographs

After having labeled the edges of prographs and recovered the three-row standard Young tableaux, it seems natural to investigate what we obtain when we label operators (boxes in the prographs). For n a non-negative integer, a prograph of $PC(n)$ contains n coproducts and n products, therefore, the labels will run from 1 up to $2n$. We will still use depth-left first algorithm to label operators of prographs since it preserves the Schützenberger involution.

[Figure 6](#) displays the labeling of operators for a prograph having 4 products and





4321	(0,0,0,0)		3214	(0,0,0,1)		4213	(0,0,1,1)	
4312	(0,1,1,1)		3241	(0,0,0,2)		2143	(0,0,1,2)	
3142	(0,1,1,2)		4231	(0,0,2,2)		4132	(0,1,2,2)	
3421	(0,0,0,3)		2413	(0,0,1,3)		3412	(0,1,1,3)	
2431	(0,0,2,3)		1432	(0,1,2,3)				

Figure 5: The 14 permutations of size 4 avoiding (123), their corresponding non-decreasing parking functions and binary trees.

coproducts, and its reverse.

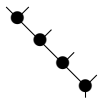
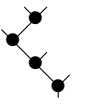
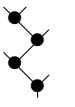
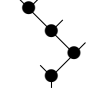
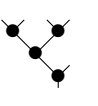
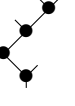
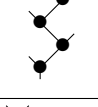
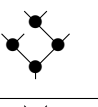
Proposition 5.1. *After having labeled product-coproduct prographs with the depth-left first algorithm, we can associate a step $(1, 1)$ with values labeling coproducts and a step $(1, -1)$ with values labeling products. With such substitutions, the word $123 \dots (2n)$ becomes a Dyck path.*

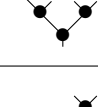
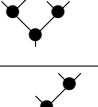
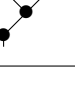
Proof. The current height of the path is the number of active outputs minus one as the prograph is partially filled. Therefore the path remains over the horizontal axis. A primitive prograph (in the sense of an Hopf algebra element) is a prograph whose associated Dyck path returns to the horizontal axis only at the end. \square

Definition 5.2. *Let n be a non-negative integer, we define a map dw from prographs $PC(n)$ to weighted Dyck paths of length $2n$. We scan the prograph with depth-left first search labeling the operator from 1 to $2n$ and starting a Dyck path at $(0, 0)$ and reading the operator labeled by i we build the weighted Dyck path with the following rules.*

- *If i labels a coproduct, we count the number d of open outputs left free to the left of the grafting position of coproduct i . We add a step $(1, 1)$ at the end of the Dyck path and we label this step with the integer d .*
- *If i labels a product, we count the number e of open outputs left free to the right of the grafting position of product i (right from the right input of product labeled by i). We add a step $(1, -1)$ at the end of the Dyck path and we label this step with the integer e .*

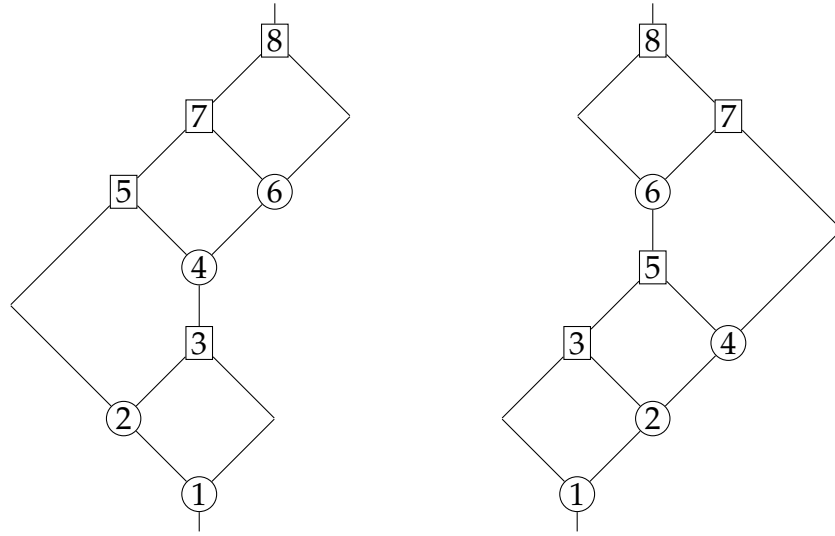

Figure 6: Labeling the operators of a prograph and its rotation.

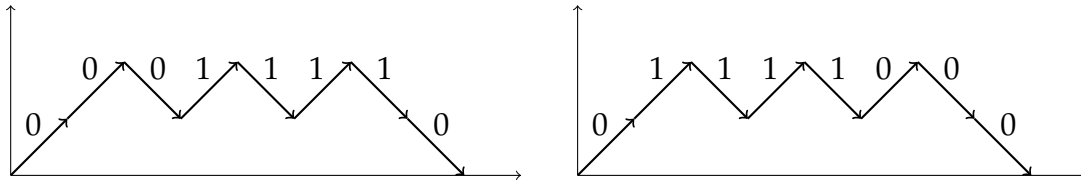

Figure 7: Weighted Dyck paths associated with the prographs of **Figure 6**.

Proposition 5.3. *The map dw is a bijection from $PC(n)$ to weighted Dyck paths of length $2n$ whose weight satisfies the following assertions:*

- *All weights of step $(1, 1)$ are non-negative integers smaller than or equal to the starting height.*
- *All weights of step $(1, -1)$ are non-negative integer smaller than or equal to the ending height.*
- *Weight are non decreasing on successive rises.*
- *Weight are non increasing on successive descents.*
- *On peaks of height h where d is the weight of a step $(1, 1)$ just followed by a descent $(1, -1)$ labeled by e , we have: $e + d \leq h$.*
- *On valleys at height h where e is the weight of a step $(1, -1)$ just followed by a rise $(1, 1)$ labeled by d , we have: $d + e \geq h$.*

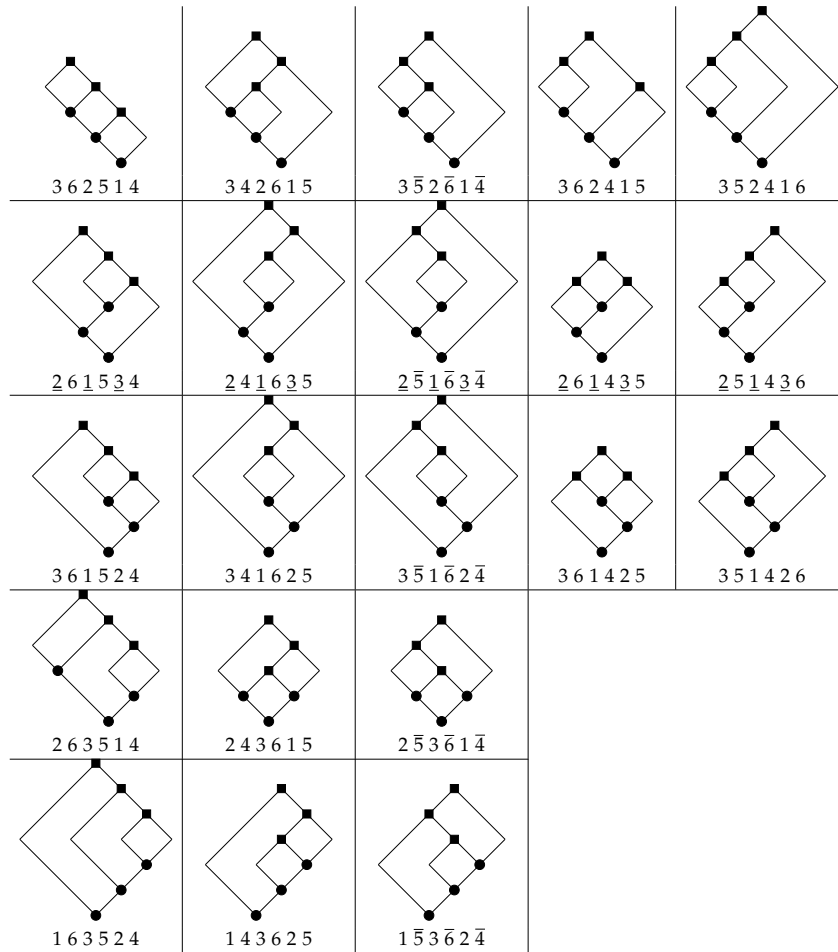

Figure 8: The 21 prographs associated with their up-down permutations of size 6 avoiding (1234) such that coproducts are labeled by 1, 2 and 3 and products are labeled by 4, 5 and 6 (eq. $Vals(\sigma) = \{1, 2, 3\}$ and $Peaks(\sigma) = \{4, 5, 6\}$ on permutations).

Since our weighted Dyck paths in Proposition 5.3 are Laguerre histories, we try in a first approach a customization of the Françon-Viennot bijection [3] to obtain up-down permutations. All the variants we tested give up-down permutations which do not necessarily avoid (1234), therefore we need more to solve Conjecture 4.2.

Nevertheless, we have a bijection for prographs of $PC(n)$ such that $Vals = \{1, 2, \dots, n\}$ and $Peaks = \{n + 1, n + 2, \dots, 2n\}$ by using twice the bijection displayed in Figure 4 and Proposition 4.3 applied with these special conditions. Figure 8 presents this bijection in size 3.

We are currently working on primitive prographs whose associated weighted Dyck paths contain more than one peak. For all partitions of $\{1, 2, \dots, 2n\}$ into two sets V and P , computer exploration shows that the number of up-down permutations having for

valleys V and peaks P is equal to the number of prographs whose labels of coproducts are V and labels of products are P . Therefore, we hope to extend our bijection on product-coproduct prographs making this new combinatorial class central for the study of objects counted by the 3-dimensional Catalan numbers.

Acknowledgements

The author thanks Samuele Giraudo for useful discussions and comments. His experience with operads and PROs theories were important to advise the author. This research was driven by computer exploration using the open-source mathematical software Sage [2] and its algebraic combinatorics features developed by the Sage-Combinat community [1].

References

- [1] The Sage-Combinat Community. “Sage-Combinat: enhancing Sage as a toolbox for computer exploration in algebraic combinatorics”. 2008. [URL](#).
- [2] The Sage Developers. *Sage Mathematics Software (Version 6.4)*. 2014. [URL](#).
- [3] J. Françon and G. Viennot. “Permutations selon leurs pics, creux, doubles montées et double descentes, nombres d’Euler et nombres de Genocchi”. *Discrete Math.* **28** (1979), pp. 21–35. [DOI](#).
- [4] J. B. Lewis. “Pattern avoidance in alternating permutations and tableaux (extended abstract)”. *22nd International Conference on Formal Power Series and Algebraic Combinatorics*. DMTCS Proceedings. 2010, pp. 391–402. [URL](#).
- [5] J. B. Lewis. “Generating trees and pattern avoidance in alternating permutations”. *Electron. J. Combin.* **19.1** (2012), Art. #P21. [URL](#).
- [6] S. Mac Lane. “Categorical algebra”. *Bull. Amer. Math. Soc.* **71** (1965), pp. 40–106. [DOI](#).
- [7] S. Pon and Q. Wang. “Promotion and evacuation on standard Young tableaux of rectangle and staircase shape”. *Electron. J. Combin.* **18.1** (2011), Art. #P18. [URL](#).
- [8] N. J. A. Sloane. “The On-Line Encyclopedia of Integer Sequences”. *Notices Amer. Math. Soc.* **50** (2003), pp. 912–915. [URL](#).
- [9] R. P. Stanley. “Promotion and evacuation”. *Electron. J. Combin.* **16.2** (2009), Art. #R9. [URL](#).