

Some modelling results on flexible pavements obtained with the help of Viscoroute Software

A. Chabot
LCPC

Division Matériaux et Structures de Chaussées
www.lcpc.fr/msc
Nantes - France

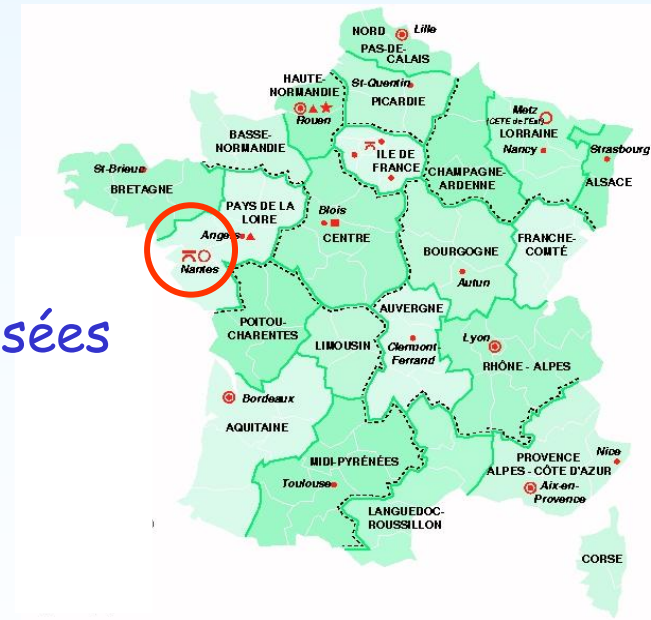

Outlines - Questions

➤ General considerations

- ✓ European and French worries in relation to loading topics
- ✓ French design method
- ✓ Some needs to improve the French method
- ✓ Actual (2006-2009) LCPC research programs

➤ For this workshop

- ✓ ViscoRoute contribution
- ✓ Informations we are interesting to get

➤ Conclusions

European norm: 40T max; 11.5T max/axle

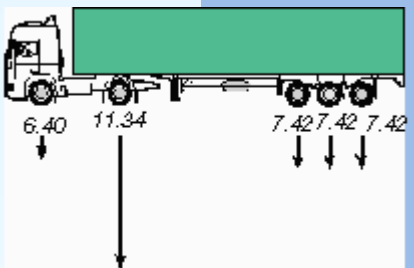

European norm and possible modifications

- 44T max (may be more?) instead of 40T for France
- 11.5T max/axle instead of 13T max for France

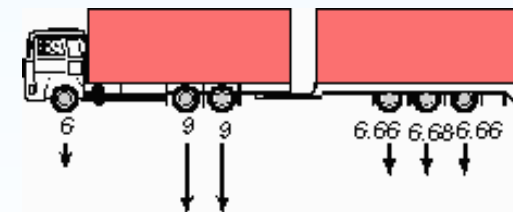
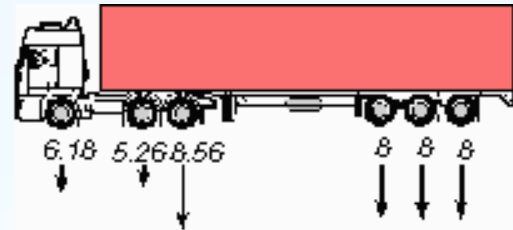
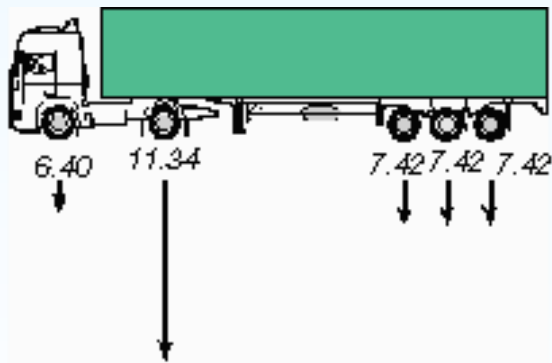

-> multi axles problems

Twin wheels or wide base tire?

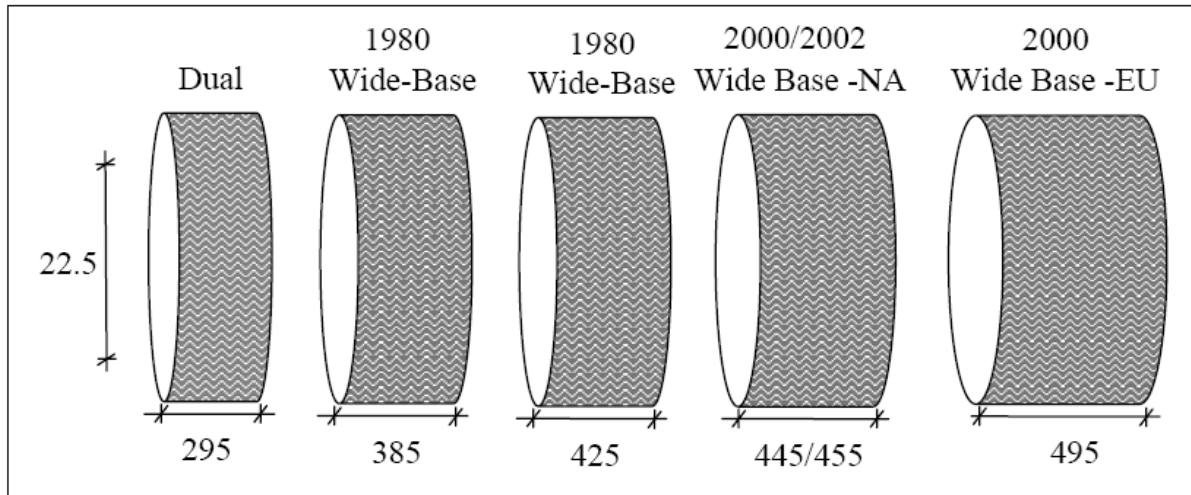

(Al Qadi et al.,2004)

NA: Designed for North America, EU: Designed for the European Union

Figure 3-1. Evolution of Wide Base Tires

AIRBUS experimentation (LCPC/STBA)



TYPICAL SIGNALS RECORDED IN THE PAVEMENT UNDER THE VEHICLE

STRAIN
Microstrain

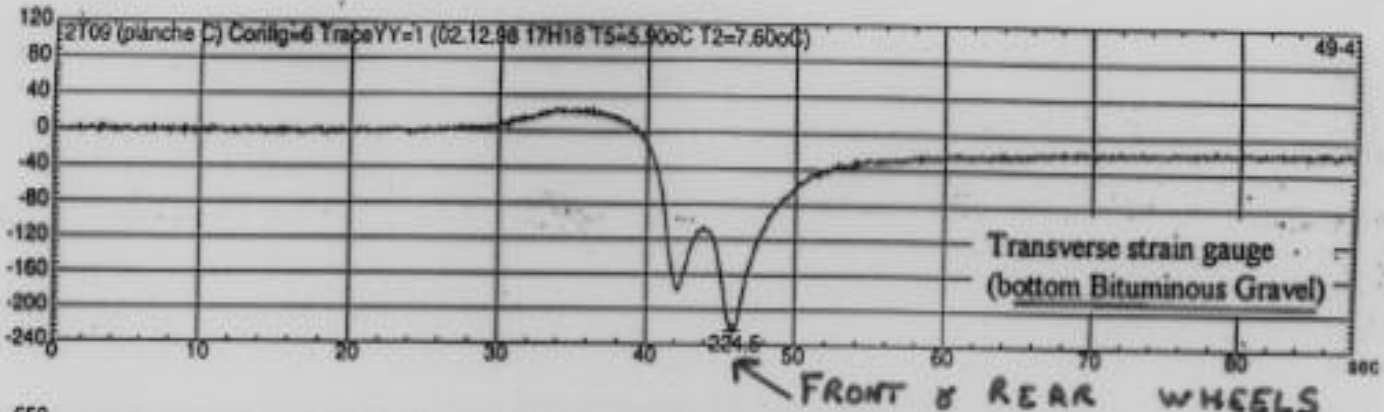
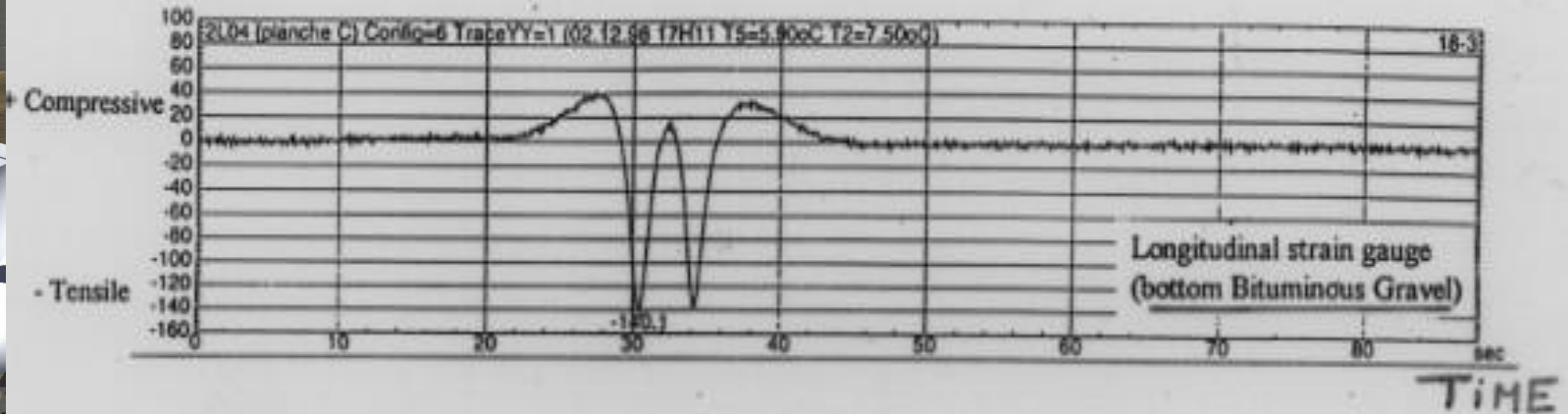

ϵ_{xx}

ϵ_{yy}

Aeronautic applications

(PEP souple 1999) (Lohf, 2005)

Section C

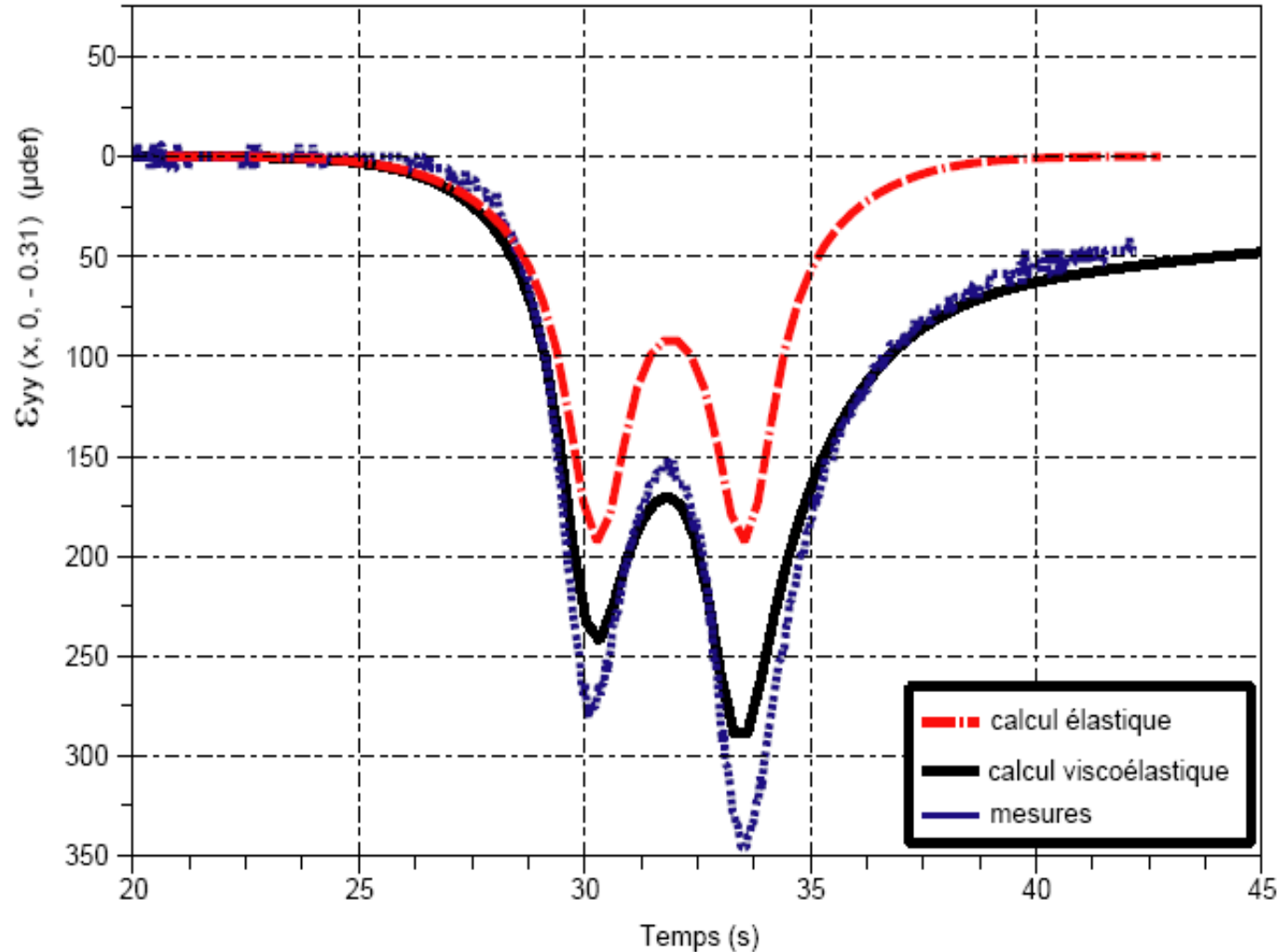
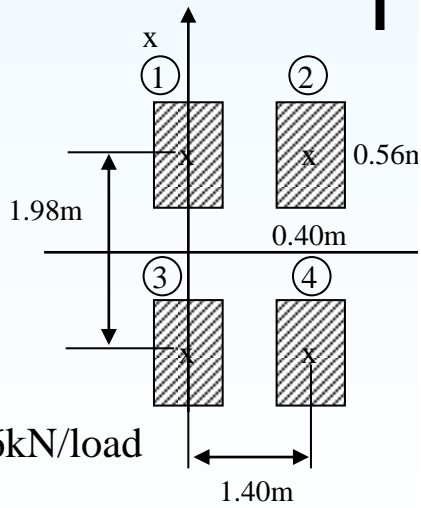
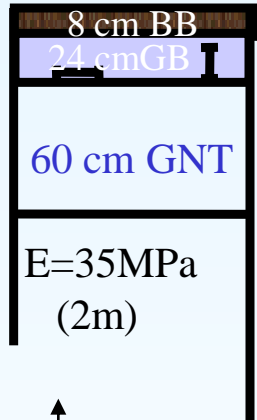

Outlines - Questions

- General considerations
 - ✓ European and French worries in relation to loading topics
 - ✓ French design method
 - ✓ Some needs to improve the French method
 - ✓ Actual (2006-2009) LCPC research programs

- For this workshop
 - ✓ ViscoRoute contribution
 - ✓ Informations we are interesting to get

- Conclusions

French design method for asphalt pavements (SETRA-LCPC, 1994)

- Based on Burmister modeling (1947)
 - ✓ Multi-layered modeling
 - ✓ Circular uniform loading
 - > 2D axisymetrical modeling, superimpose loading assumptions

 - ✓ Elastic material behavior
 - > Time and temperature / frequencies assumptions

French design method for asphalt pavements (SETRA-LCPC, 1994)

$$\varepsilon_{t,adm} \leq \varepsilon_6 \times \left(\frac{NE}{10^6} \right)^b \times kc \times kr \times ks \times kd$$

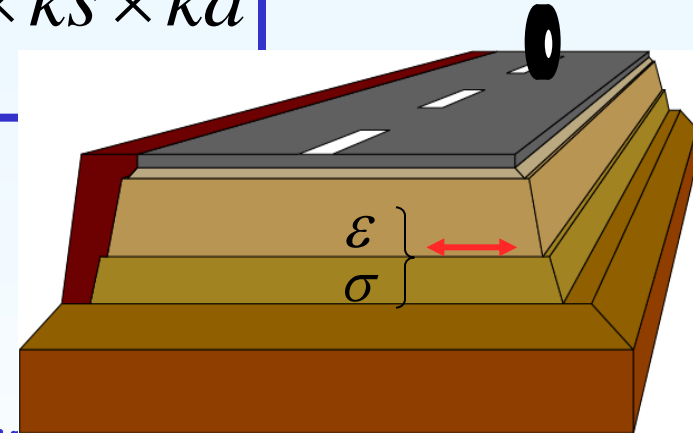

NE: number of equivalent ref. axles (France -> twin wheels 130kN) (norme NF 98-082)

b: fatigue slope

ki: factors (uncertainties: traffic risk, structure type, thickness layers, ...)

The French design method OK



Relative good predictions for design problems

Outlines - Questions

- General considerations
 - ✓ European and French worries in relation to loading topics
 - ✓ French design method
 - ✓ Some needs to improve the French method
 - ✓ Actual (2006-2009) LCPC research programs

- For this workshop
 - ✓ ViscoRoute contribution
 - ✓ Informations we are interesting to get

- Conclusions

For diagnostic problems ->Some pavement needs

1. Crack discontinuities modeling for cement concrete structure
2. Viscoelastic behavior of asphalt materials for flexible pavement
3. No-linearity behavior of sub-base and subgrade layers
4. Better modeling of multi-loadings and tire-pavement contact
5. ...

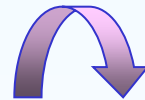

- LCPC research programs (2006-2009):
 - Up to date French Design method (P. Hornych)
 - Fundamental Modelings (A. Chabot, <http://or.lcpc.fr/fondephy>)

The needs

**For engineers A fast tool needs
to be used
(with semi-analytical solutions)**

➤ **TODAY:**

Crack discontinuities modeling for cement concrete structure

- Viscoelastic behavior of asphalt materials for flexible pavements
- No-linearity behavior of sub-base layers
- Better modeling of multi-loadings and tire-pavement contact

Software ViscoRoute

(Duhamel et al., BLPC2005)
(Chabot et al., ICAP2006)

**A. Chabot, P. Tamagny, *D. Duhamel
D. Poché, A. Lohf, T. Nguyen, Senti A.**

**Division Matériaux et Structures de Chaussées
LCPC - Centre de Nantes - France**

*** Laboratoire Analyse des matériaux et Identification
ENPC - Marne la Vallée - France**

Complex modulus measurement

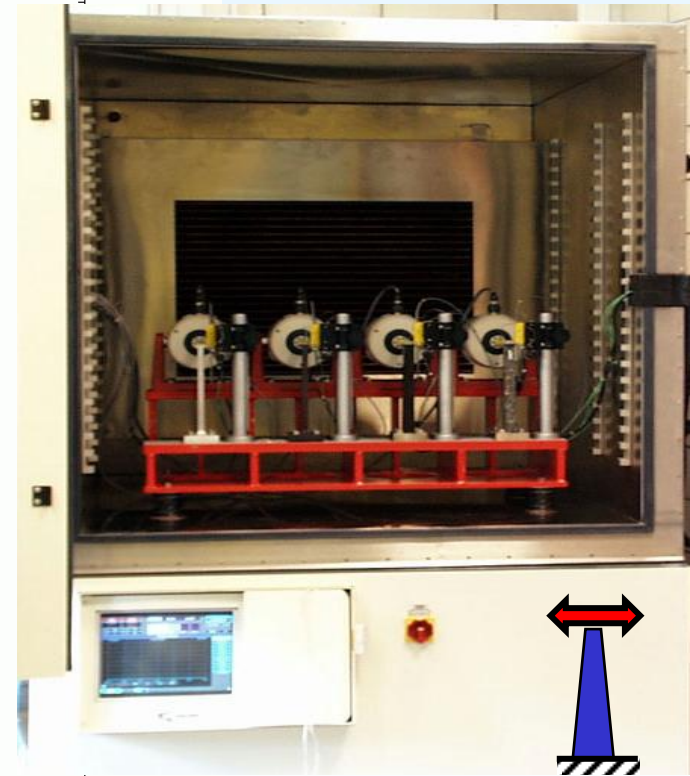
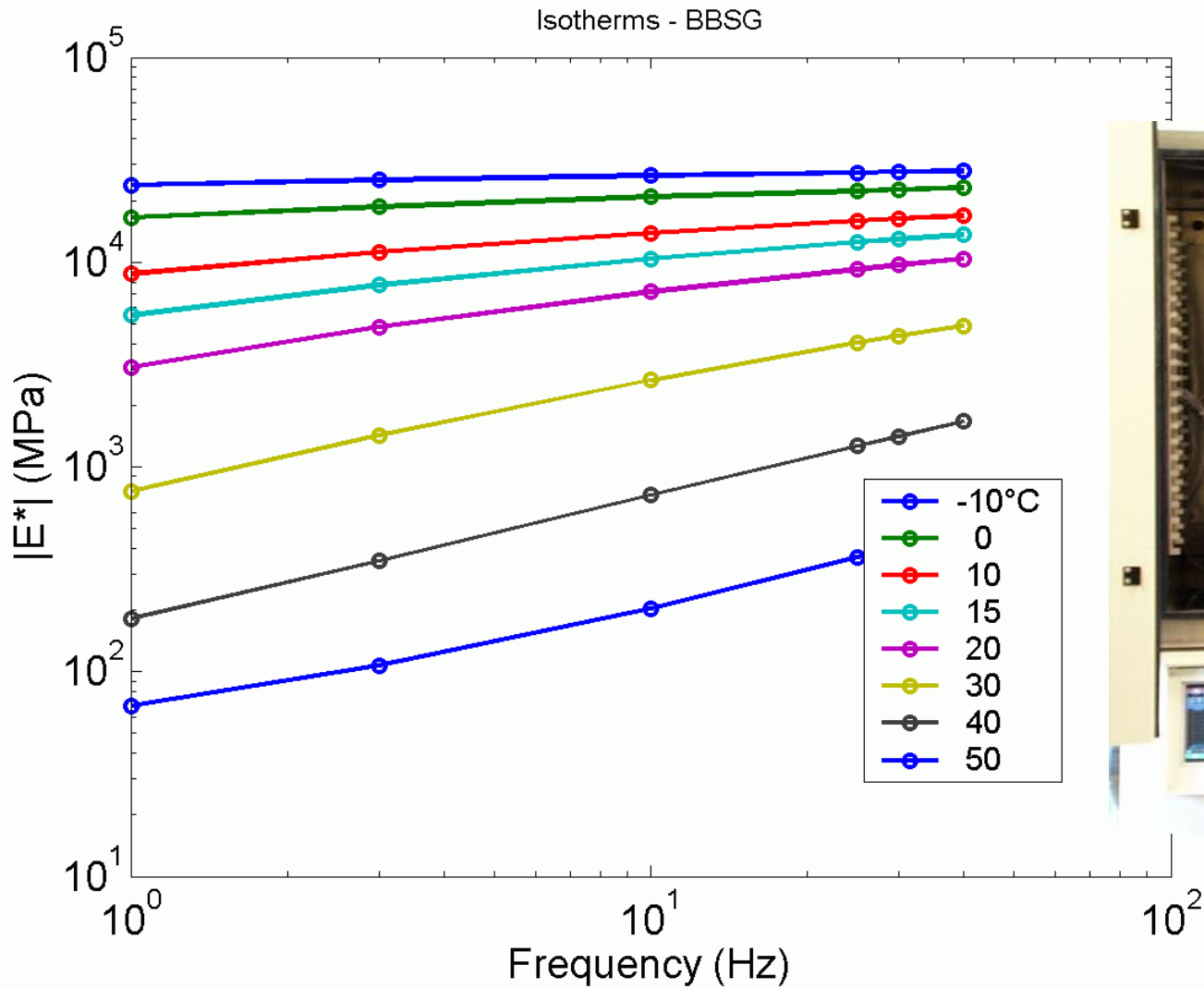

1. Huet-Sayegh modeling (1965)

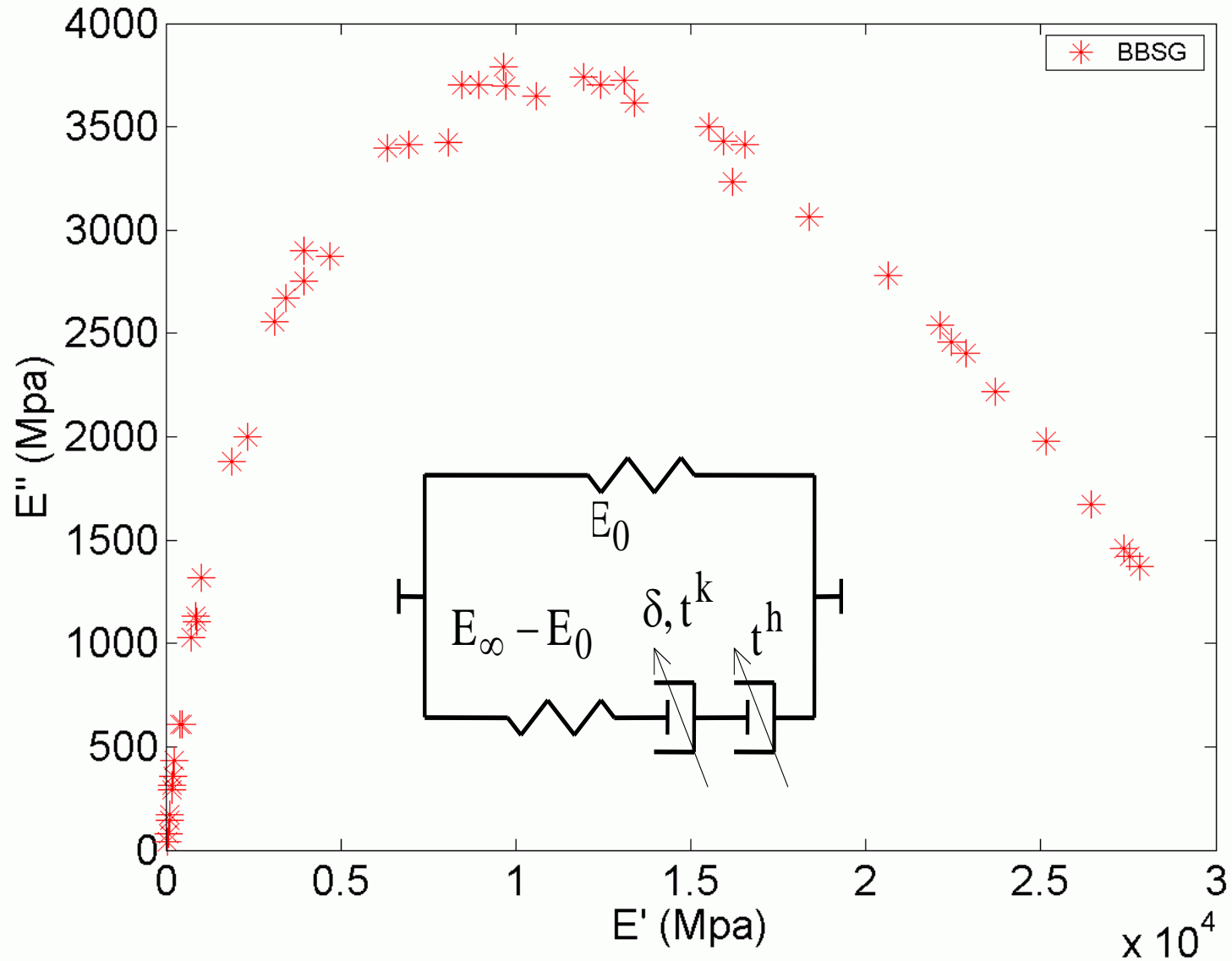

1. Huet-Sayegh modeling (1965)

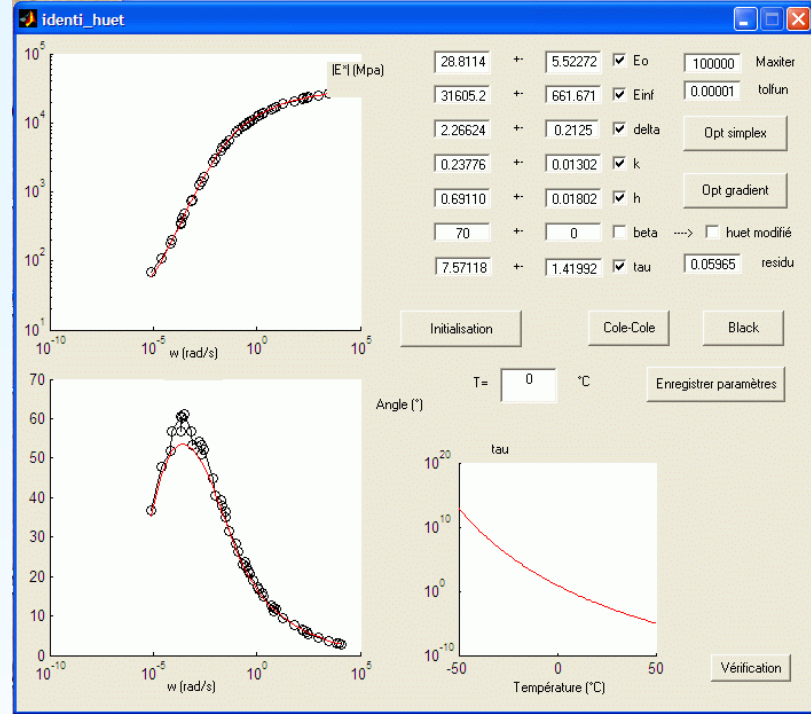
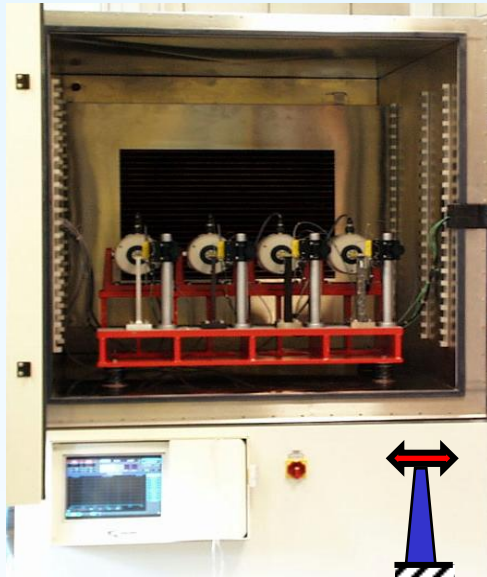

Viscoanalyse Software (Chailleux, 2006)

<http://www.lcpc.fr/fr/produits/viscoanalyse/index.dml>

(1 > h > k > 0)

$$E^*(\omega, \theta) = E_0 + \frac{E_\infty - E_0}{1 + \delta (j\omega\tau(\theta))^{-k} + (j\omega\tau(\theta))^{-h}}$$

$$\tau(\theta) = \exp(A_0 + A_1\theta + A_2\theta^2)$$

(Huet 1963), (Huet, *Mechanics and Materials*, 31, 1999),

(Sayegh, 1965)

1. And/Or ... ViscoMatData

- Project 2007:

Data base for complexe modulus behavior of bitumen, asphalt and other viscoelastic materials coefficient (Huet, Huet-Sayegh, prony series,... s) and fatigue- damage parameters

- Internet and intranet base

- To follow...

2. Structural mechanical modelling

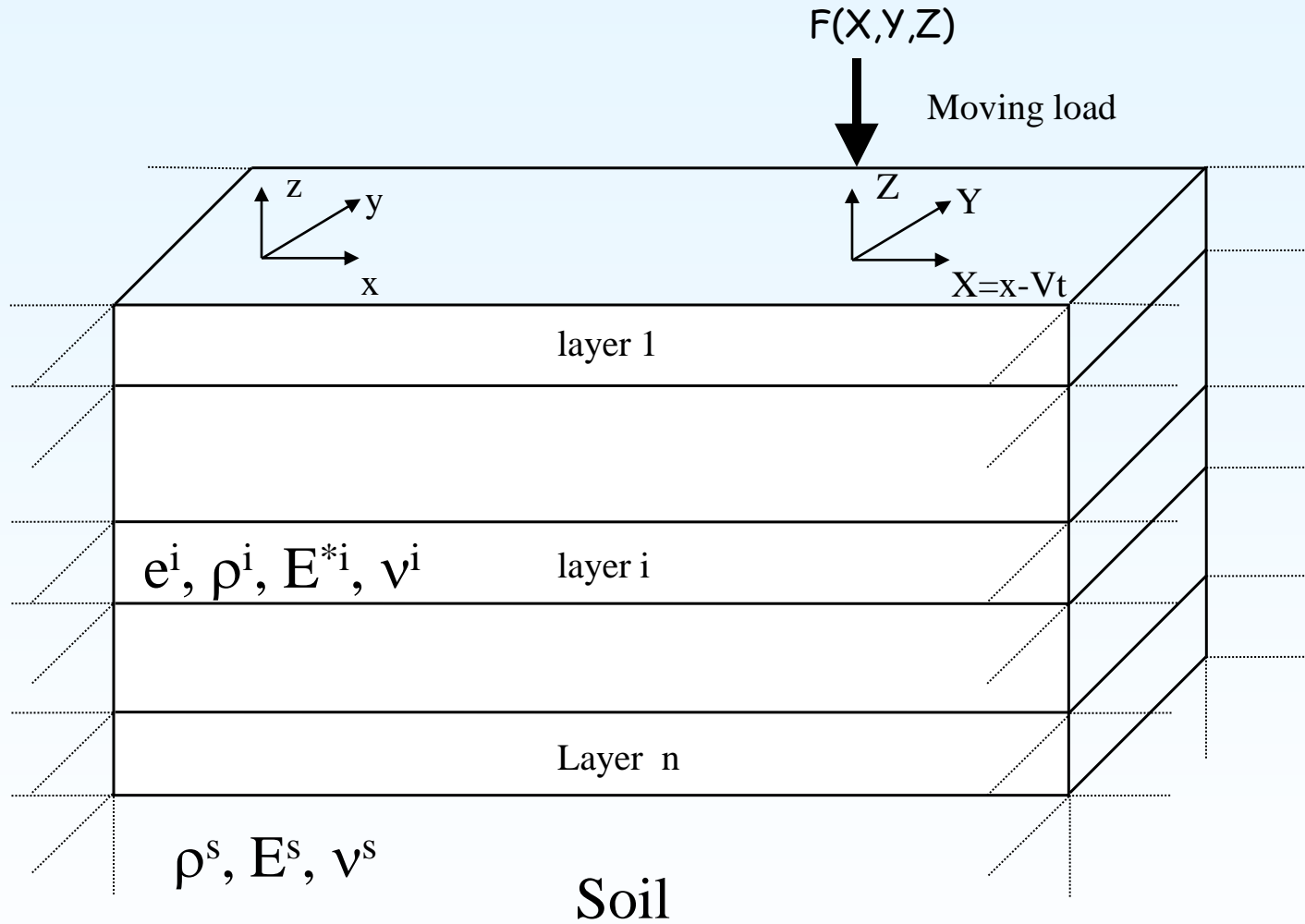

Method (Nguyen, 2002)

The Time dependance problem can be solve with:

- Change of variables

$$(x, y, z) \rightarrow (X - Vt, Y, Z)$$

- Use of double Fast Fourier Transform

$$(X - Vt, Y, Z) \rightarrow (p, q, Z)$$



Analytical Elastic problem

$$A_i \frac{\partial^2 \hat{\hat{u}}(p, q, Z)}{\partial Z^2} + jB_i \frac{\partial \hat{\hat{u}}(p, q, Z)}{\partial Z} - C_i \hat{\hat{u}}(p, q, Z) = 0$$

Viscoroute kernel (Duhamel et al., BLPC2005)



- Solutions in Fourier(p, q, Z) frame: 6 complex constants

$$\hat{\tilde{u}}_1(p, q, Z) = p\beta_{1i}^- e^{-\kappa_p Z} + \kappa_s \beta_{3i}^- e^{-\kappa_s Z} + p\beta_{1i}^+ e^{\kappa_p Z} - \kappa_s \beta_{3i}^+ e^{\kappa_s Z}$$

....

- Solutions in real (X, Y, Z) frame:

$$f(X, Y, Z) = \frac{1}{4\pi^2} \int_{-\infty}^{+\infty} \int_{-\infty}^{+\infty} \hat{f}(p, q, Z) e^{i(pX + qY)} dp dq$$



Use of double Inverse Fourier transform method



Définition de la structure de base

Ajouter une couche Supprimer une couche

N°	Z (m)	Epais. (m)	Mod. El (MPa)	Coef. de Poisson	Mas. Vol. (kg/m3)	Type de matériau	Type de couche	Type de liaison	Mod ES (MPa)	Tempé. (°C)	Coef. "k" loi H-S	Coef. "h" loi H-S	Coef. "d" loi H-S	Coef. "A0"	Coef. "A1"	Coef. "A2"
N° 1	0.000	0.085	34000	0.25	1000	autre	Viscoélastique		70	11.4	0.22	0.65	2.8	1.94	-0.373	0.00191
N° 2	0.085	0.43	130	0.35	1000	autre	Elastique	Collée	0	15	0	0	0	0	0	0
N° 3	0.515	infini	50	0.35	1000	autre	Elastique	Collée	0	0	0	0	0	0	0	0



Laboratoire Central des Ponts et Chaussées



Paramètres de calcul

Structure en cours: Z:\2004.blpc\interface\ISSCE.str

Chargement en cours: Z:\2004.blpc\interface\ISSCE.cha

Coordonnées du vecteur force en Newton

Fx: 0.00000 Fy: 0.00000 Fz: 32500.0000 Vitesse de la charge en m/s: 18.83333

Niveaux d'observation

Nombre: 2 N° de la côte: Côte N° 2 Côte d'obs. (m): 0.08 Sortie: uz (m)

VISCOROUTE - [Tracer en plan]

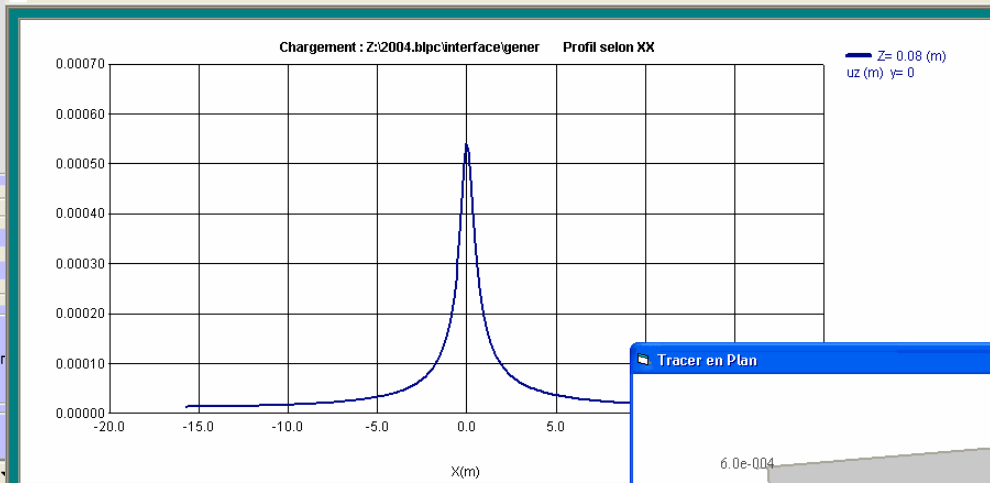

Affichage Graphique

Type d'échelle des abscisses: Automatique Type d'échelle des ordonnées: Automatique

Min (m): -1 Max (m): 1 Min: -1 Max: 1

Choix du tracer: Tracer en plan Profil selon XX Profil selon YY

Pt d'observation: 0.08 uz (m)

Sauvegarder le dessin

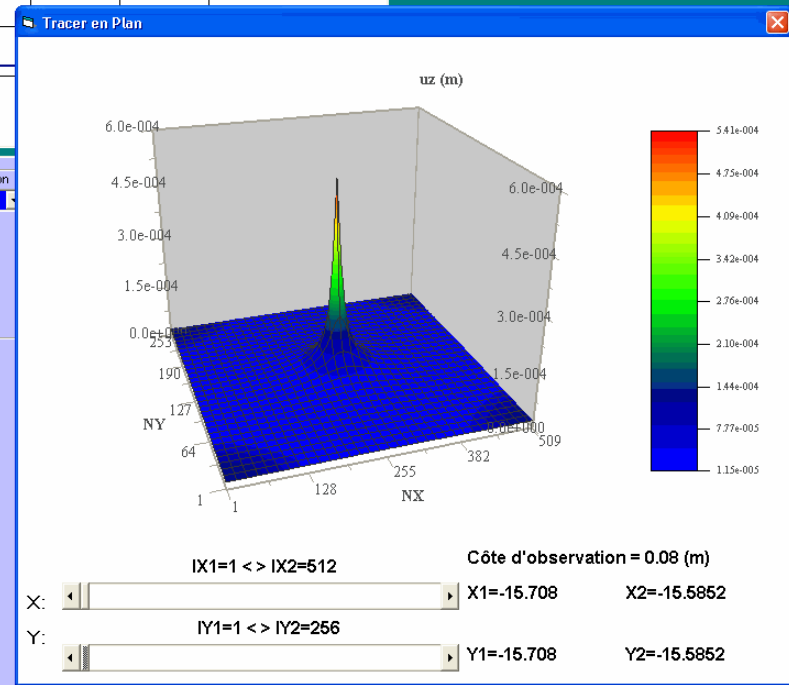

Viscoroute-v1:

(Duhamel D., Chabot A., Tamagny P., Harfouche L., BLPC 2005)

Comparison Applications

Validations

(Duhamel et al., BLPC 2005)
(Chabot et al., ICAP 2006)

1. Calculus: ALIZE, CVCR (3D FEM)
(Heck et al., 1999)
2. Experimental datas (fatigue tests)



Manège de fatigue
of LCPC-Centre de
Nantes



Viscoroute Post-treatment development

(Senti, 2007)

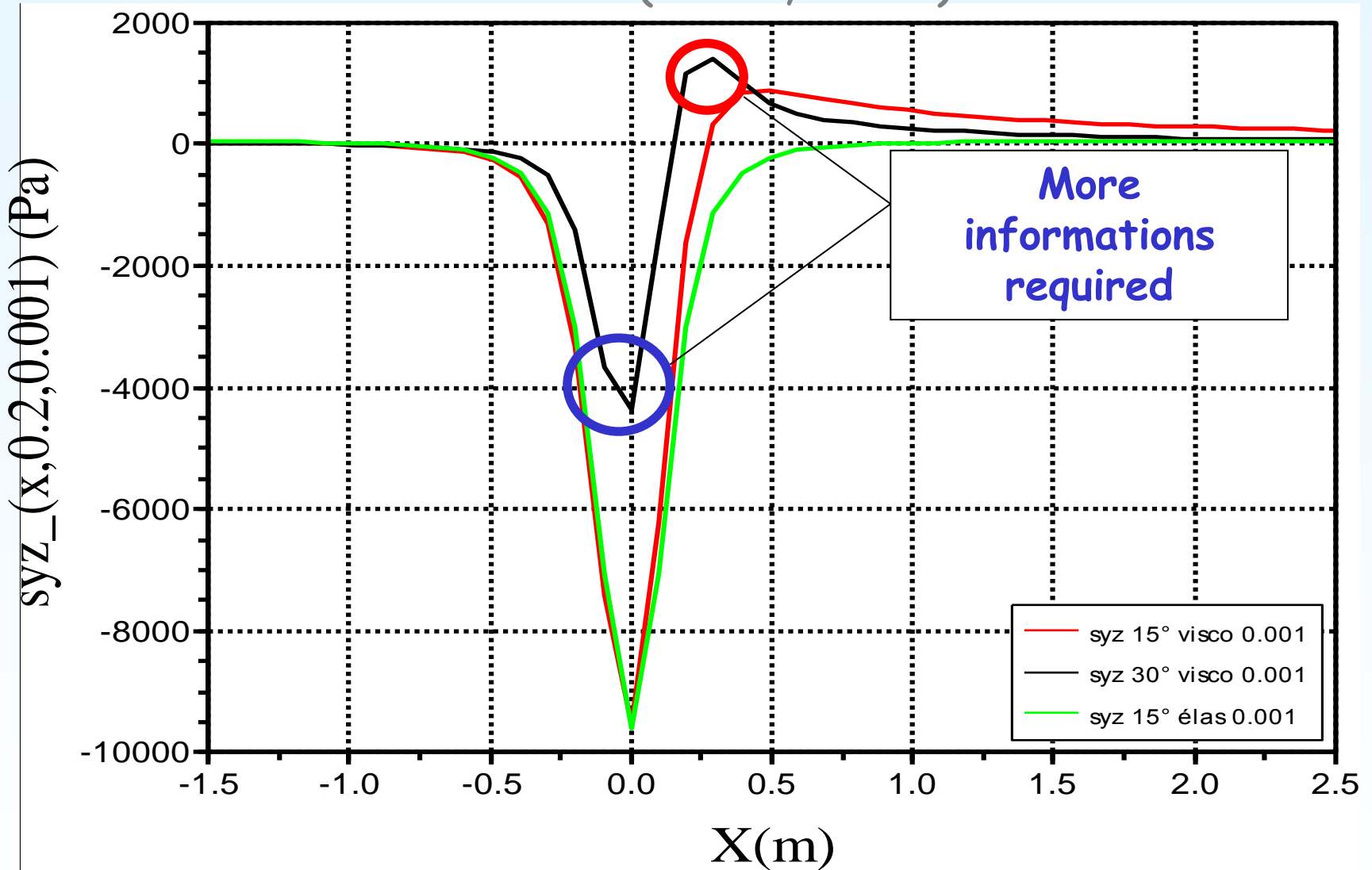

Use of Shannon theorem

(Scilab post-treatment - Senti, 2007)

- If $f(t)$ finite,
- If $f(t)$ is zero on its edge then

$$f(t) = \sum_{n=-\infty}^{+\infty} f(na) \frac{\sin \frac{\pi}{a} (t - na)}{\frac{\pi}{a} (t - na)}$$

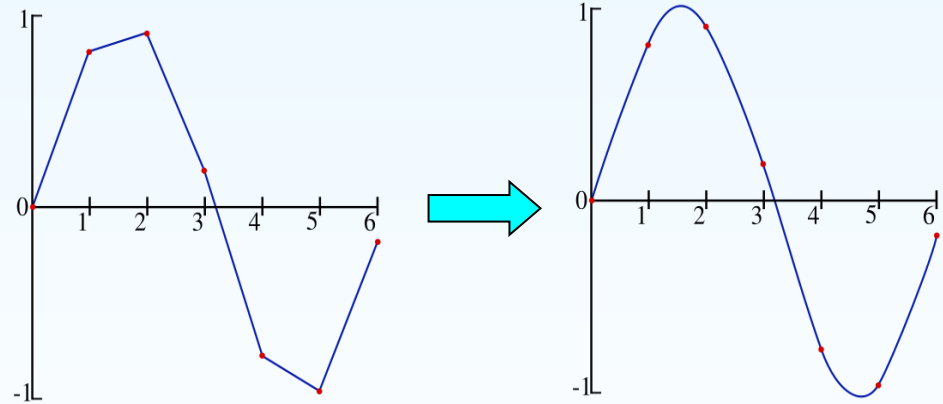

✓ The signal is perfectly rebuilt

Comparison with Veroad results (Nilsson et al., RMPD2002) (Senti, 2007)

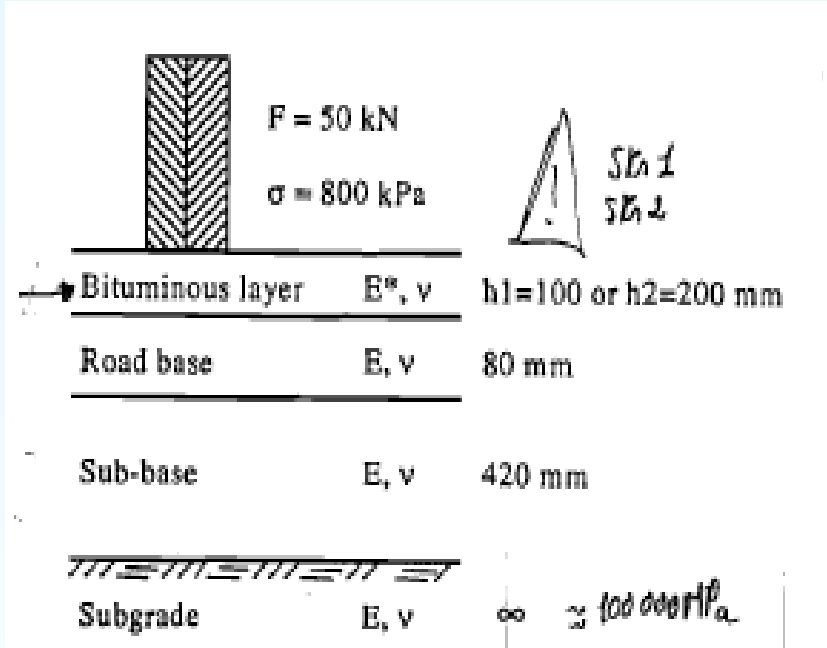

E_u	E_0	δ	k	h	a	b	c
33000	43	2,55	0,269	0,75	-0.86135	-0.37499	0.004534

Layer	Winter (< 0°C)	Thaw (~ 0°C)	Summer (20°C)	Autumn (10°C)
Road Base	1000	300	450	450
Sub-Base	450	450	450	450
Subgrade	1000	35	100	100

Loading area

- Veroad : $R=140\text{mm}=0.14 \text{ m}$ - $S=\pi \cdot R^2=0.0616 \text{ m}^2$
- Viscoroute-v1: $2a=2b=0.24814 \text{ m}$

**Maximum Structure 2 strains
 (z=0.2m) depending on speed
 and temperature (Senti, 2007)**

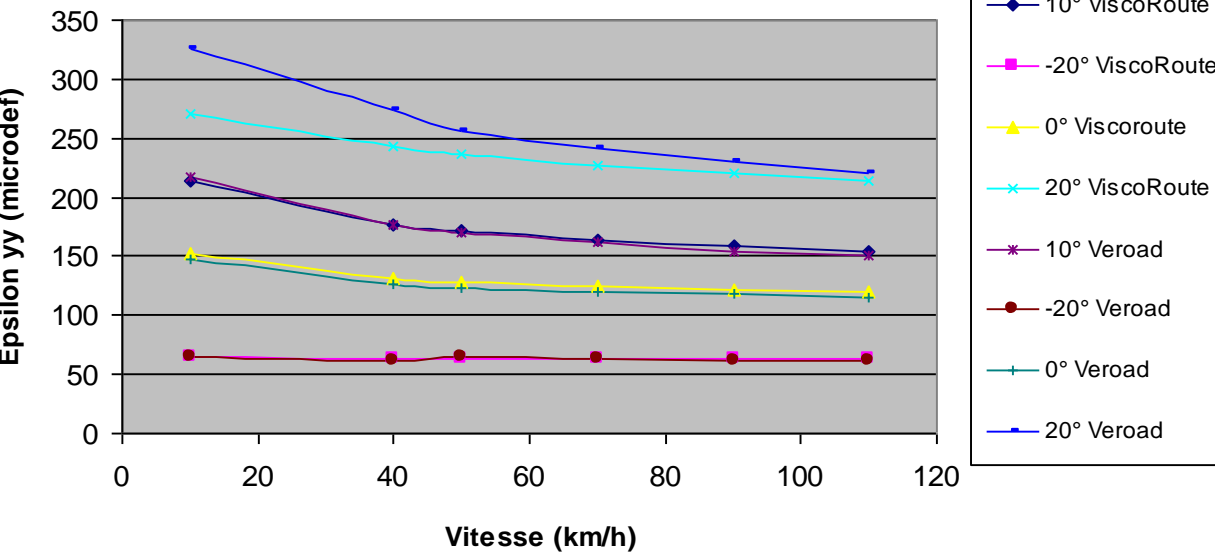
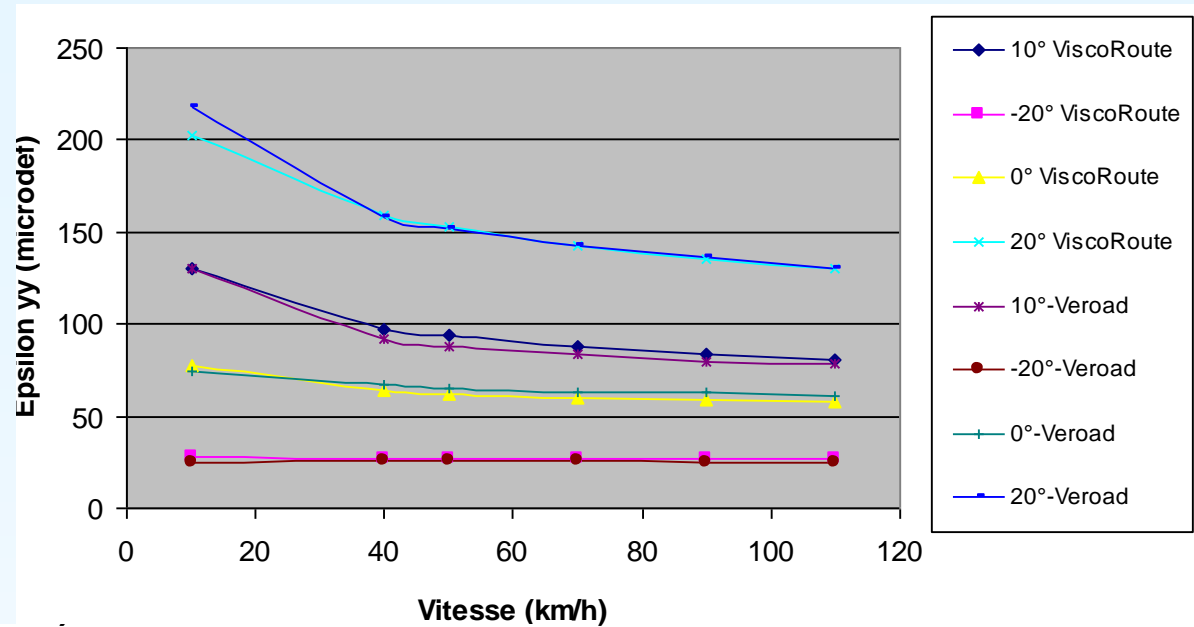

**Maximum Structure 1 strains
 (z=0.1m) depending on speed and
 temperature (Senti, 2007)**

Top - down cracking (Tamagny et al., CP2004)

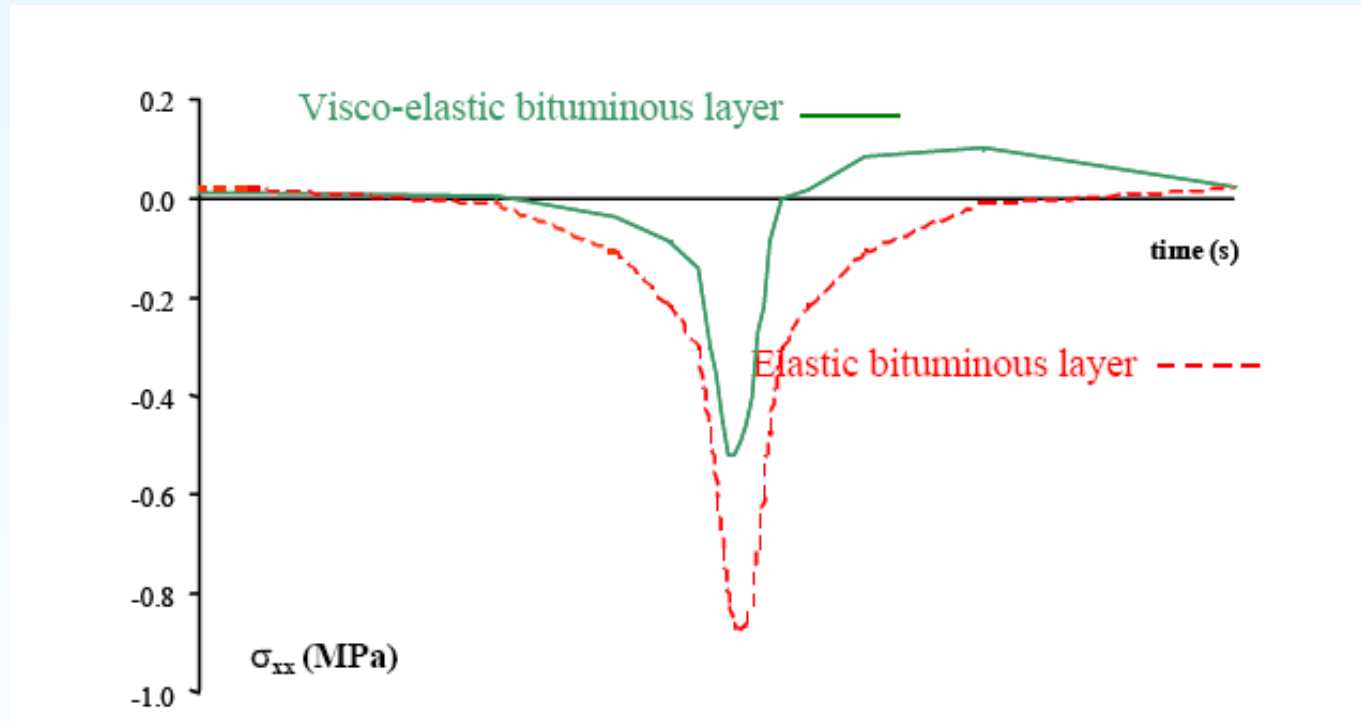

3D viscoelastic calculus with CVCR- César FEM code
(Heck et al, 1998)

Study of viscoelastic effects on the top of the pavement (Senti, 2007)

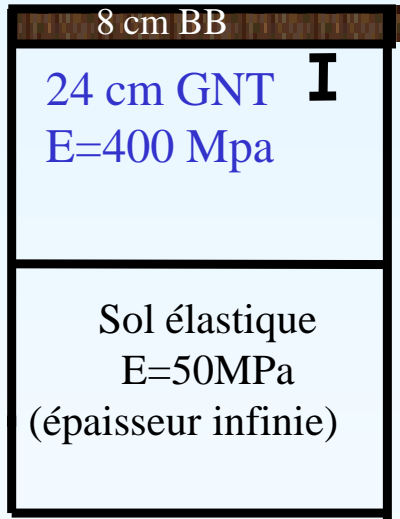

Epaisseur de la couche (m)	0.08
E_{∞}	35 000
E_0	70
δ	2.9
h	0.62
k	0.19
ν	0.35
Température, θ (°C)	15
A_0	1.377
A_1	-0.35698
A_2	0.001743

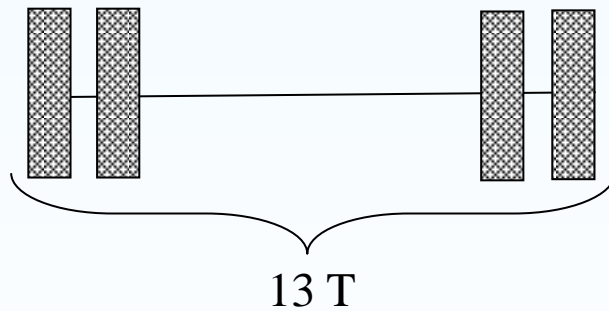

→ dual tire = 6,5 T

→ single = 3,25 T = 0,662 MPa → single = 32500 N

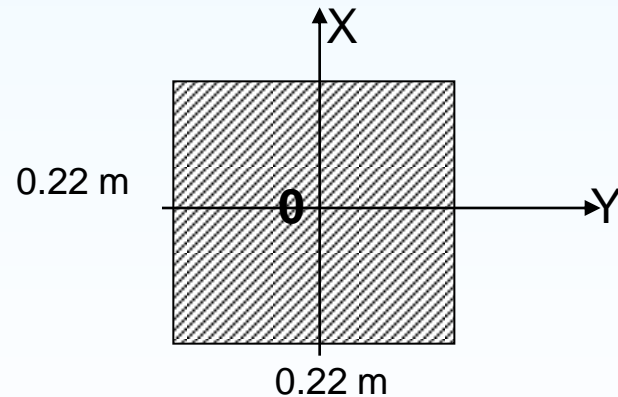

Study of viscoelastic effects on the top of the pavement (Senti, 2007)

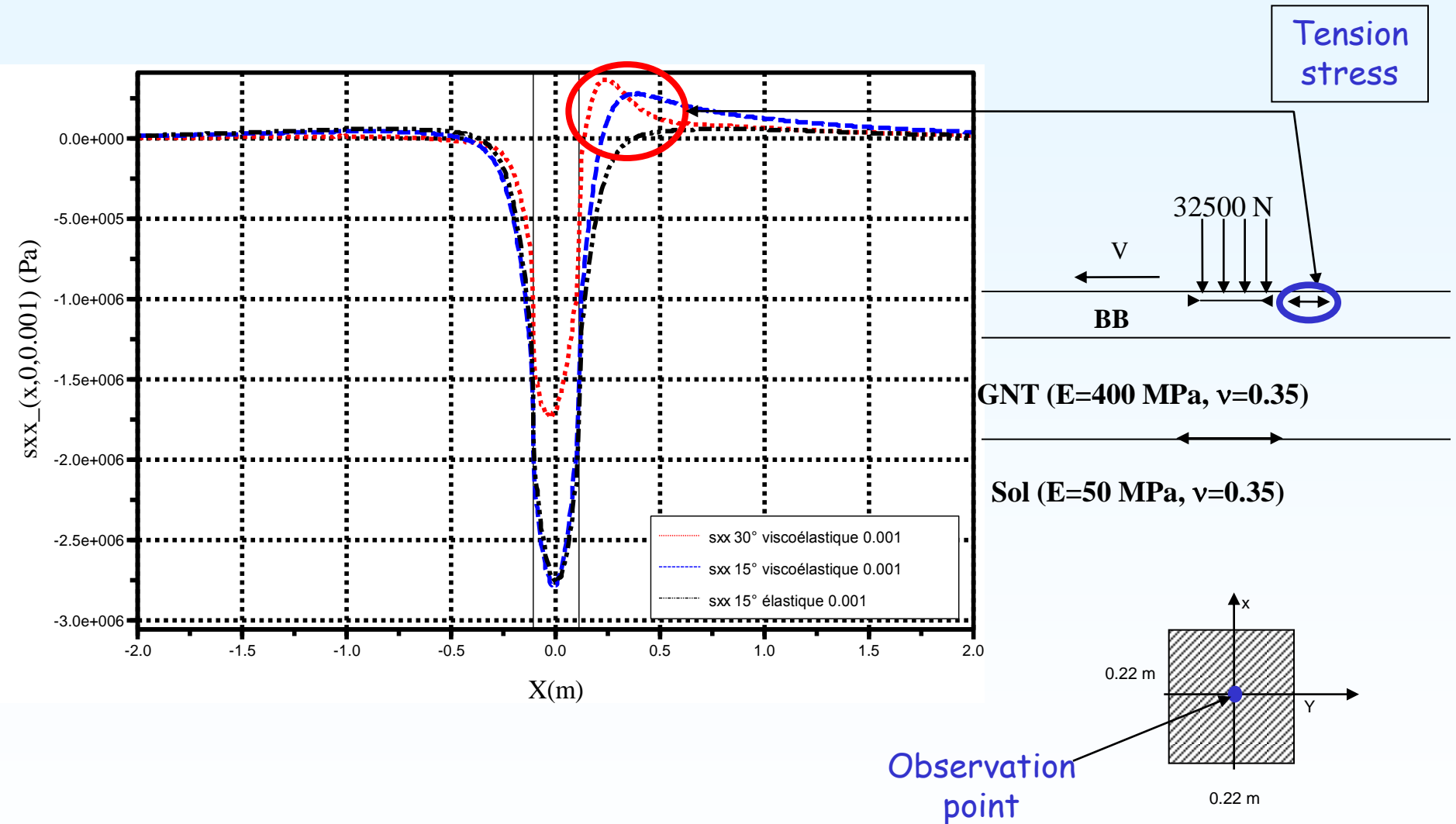

Study of viscoelastic effects on the top of the pavement (Senti, 2007)

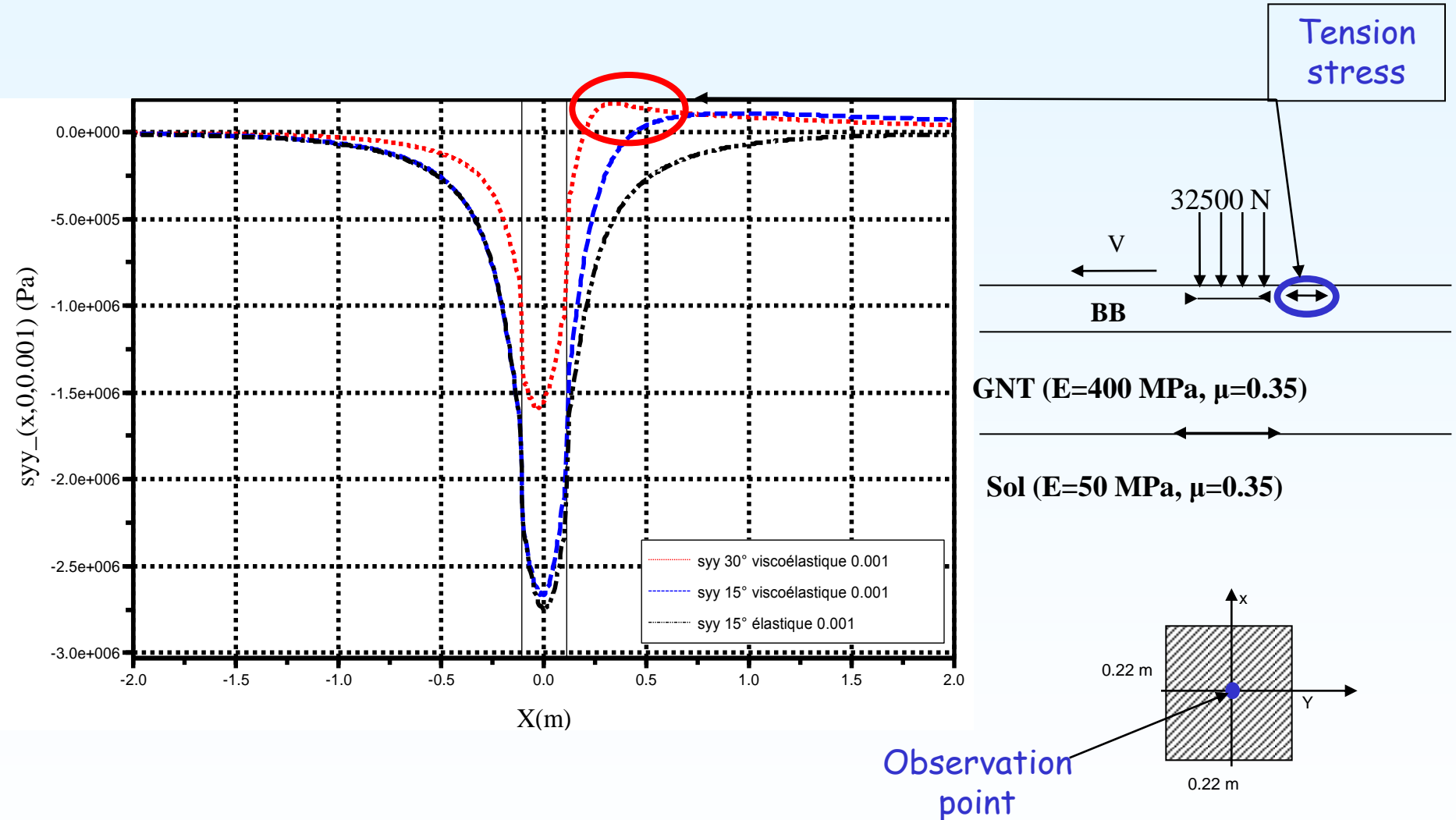

Study of viscoelastic effects on the top of the pavement (Senti, 2007)

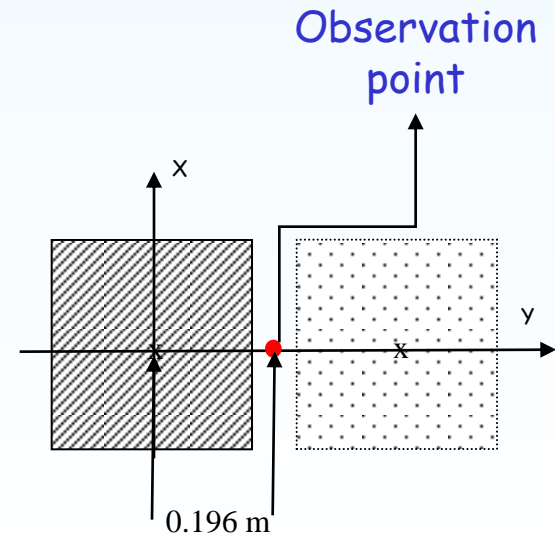
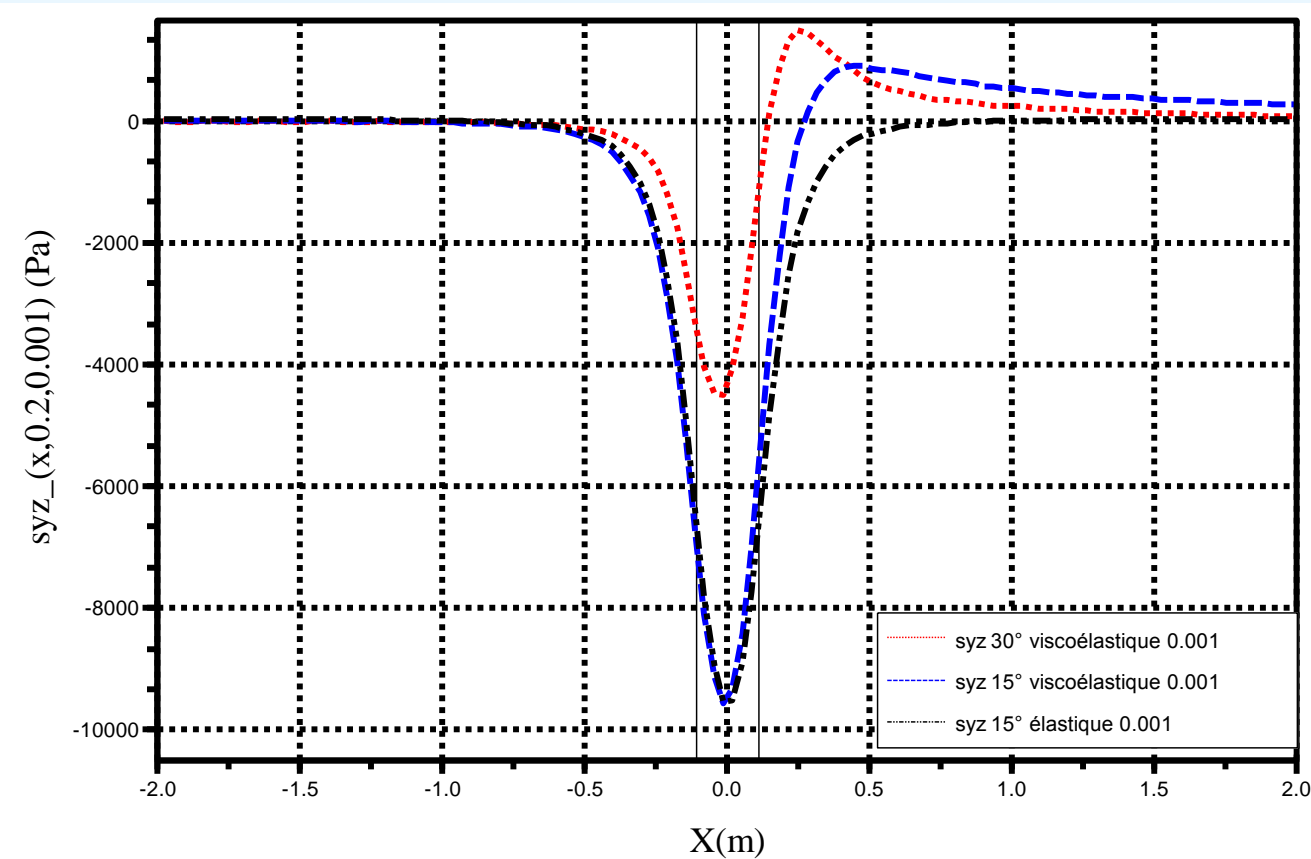

Outlines - Questions

- General considerations
 - ✓ European and French worries in relation to loading topics
 - ✓ French design method
 - ✓ Some needs to improve the French method
 - ✓ Actual (2006-2009) LCPC research programs

- For this workshop
 - ✓ ViscoRoute contribution
 - ✓ Informations we are interesting to get

- Conclusions

Prospects - Interest 1

- Introduction of no-uniforme loading coming from:
 - ✓ The literature (De Beers et al., 1997, ICAP2006),
 - ✓ Experimental data (LCPC research program 2006-2009)

(Hamlat et al., 2006)

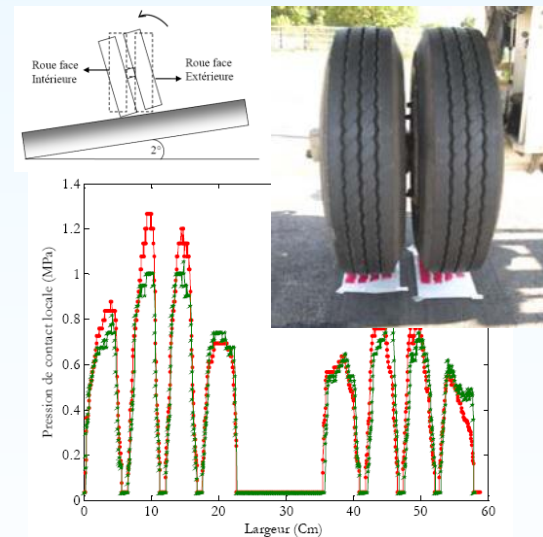

- ✓ That group?

Prospects - Interest 2

- Comparison with other results coming from 3D-Move (Siddharthan et al., 1998), 3D Abaqus FEM (Al Qadi et al., 2004)

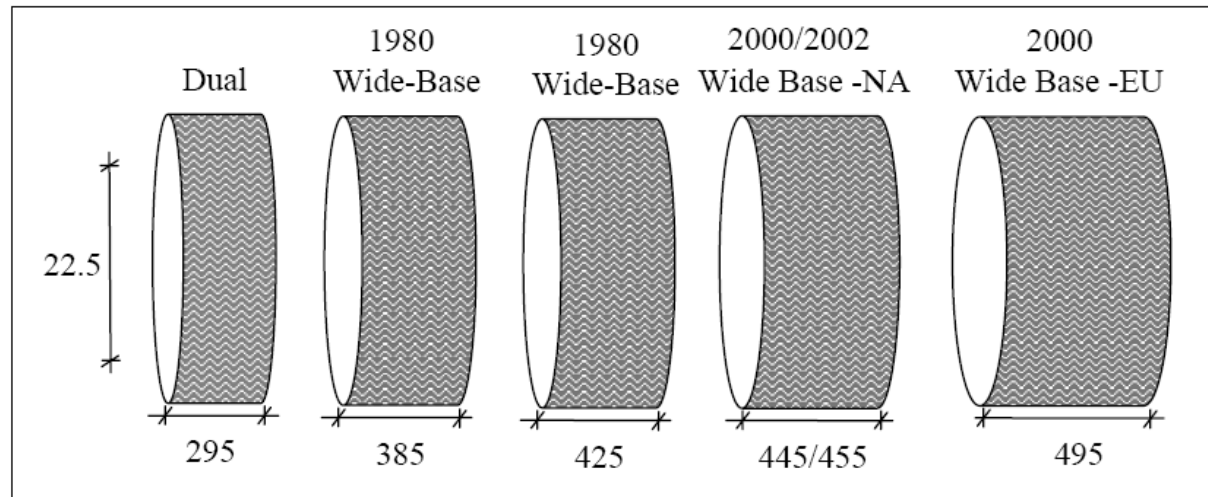

NA: Designed for North America, EU: Designed for the European Union

Figure 3-1. Evolution of Wide Base Tires

(Al Qadi et al., 2004)

Interest 3: Data analyse of old Load configurations ALT



LCPC manege tests

- 1997 - Michelin test data on dual-tire comparison with wide base-tire
 - April 1999 - COST 334
 - Juillet-septembre 1999 - rutting test TVM (Trans Val de Marne) - Michelin tires- tramway - ringB -
- > wide base tire equivalent to dual tire?

Examples of tests



Fatigue experiment on
asphalt pavement



Rutting experiment on
asphalt pavement (ultra
canalized urban traffic)

Outlines - Questions

- General considerations
 - ✓ European and French worries in relation to loading topics
 - ✓ French design method
 - ✓ Some needs to improve the French method
 - ✓ Actual (2006-2009) LCPC research programs

- For this workshop
 - ✓ ViscoRoute contribution
 - ✓ Informations we are interesting to get

- Conclusions

Conclusions

Free downloading on www.lcpc.fr/fr/produits/

- **ViscoAnalyse- V1 Software** (Chailleux et al., RMPD 2006)
- **ViscoRoute -V1 software** (Duhamel et al., BLPC2005)
 - ✓ 3D modeling
 - ✓ 1 rectangular uniform loading - (vertical and shear forces)
 - ✓ Bonding layers
 - ✓ Elastic and huet-Sayegh viscoelastic behavior
 - ✓ Fast, Applications (design: $F \Leftrightarrow V$, $T^{\circ}C$, exp., consumption calculus, ...)
 - ✓ available at the end of 2007

-> coming soon ViscoMatdata

Prospects

- Validations for viscoroute-V2 (O. Chupin)
 - ✓ Elliptical and rectangular loading + multi loading effects
 - ✓ Non uniforme loading introduction
- Viscoroute-V3 - 2008 (O. Chupin)
 - ✓ Debonding between layers
- non linearity of the soil?...
 - > 3D FEM Cesar-LCPC -> ORNI
 - > LCPC research program (<http://or.lcpc.fr/fondephy>)

Thanks for your attention

