



HAL
open science

Comparisons of the performance of $\delta^{13}\text{C}$ and $\delta^{18}\text{O}$ of *F. sylvatica*, *P. sylvestris* and *Q. petraea* in the record of past climate variations

Valérie Daux, Alice Michelot-Antalik, Aliénor Lavergne, Monique Pierre, Michel Stievenard, Nathalie Bréda, Claire Damesin

► To cite this version:

Valérie Daux, Alice Michelot-Antalik, Aliénor Lavergne, Monique Pierre, Michel Stievenard, et al.. Comparisons of the performance of $\delta^{13}\text{C}$ and $\delta^{18}\text{O}$ of *F. sylvatica*, *P. sylvestris* and *Q. petraea* in the record of past climate variations. *Journal of Geophysical Research: Biogeosciences*, 2018, 123 (4), 10.1002/2017JG004203 . hal-01739286

HAL Id: hal-01739286

<https://hal.science/hal-01739286v1>

Submitted on 20 Mar 2018

HAL is a multi-disciplinary open access archive for the deposit and dissemination of scientific research documents, whether they are published or not. The documents may come from teaching and research institutions in France or abroad, or from public or private research centers.

L'archive ouverte pluridisciplinaire **HAL**, est destinée au dépôt et à la diffusion de documents scientifiques de niveau recherche, publiés ou non, émanant des établissements d'enseignement et de recherche français ou étrangers, des laboratoires publics ou privés.

Comparisons of the performance of $\delta^{13}\text{C}$ and $\delta^{18}\text{O}$ of *F. sylvatica*, *P. sylvestris* and *Q. petraea* in the record of past climate variations

V. Daux¹, A. Michelot-Antalik², A. Lavergne^{1,†}, M. Pierre¹, M. Stievenard¹, N. Bréda^{3,4}, C. Damesin⁵

¹LSCE, UMR 8212 CEA/CNRS/UVSQ, Gif-sur-Yvette, F-91191

²UMR 1121 Agronomie & Environnement Nancy-Colmar, INRA/Université de Lorraine, Vandoeuvre-les-Nancy, F-54518

³INRA, UMR 1137 Ecologie et Ecophysiologie Forestières, Champenoux, F-54280

⁴Université de Lorraine, UMR 1137 Ecologie et Ecophysiologie Forestières, Vandoeuvre-les-Nancy, F-54500

⁵Laboratoire d'Écologie, Systématique et Évolution, UMR 8079, Université Paris-Sud, Orsay, France

† Current address: Department of Life Science, Imperial College London, Ascot, UK

Corresponding author: Valérie Daux (valerie.daux@lsce.ipsl.fr)

Key Points:

- Carbon and oxygen chronologies in *F. sylvatica*, *P. sylvestris* and *Q. petraea* are consistent and strongly correlated with air moisture (VPD) and temperature.
- A large number of trees (11, on average) is needed to develop robust isotope-based paleoclimate reconstructions.
- Reconstructions in temperate Europe should concentrate on oxygen isotopic composition.

This article has been accepted for publication and undergone full peer review but has not been through the copyediting, typesetting, pagination and proofreading process which may lead to differences between this version and the Version of Record. Please cite this article as doi: 10.1002/2017JG004203

© 2018 American Geophysical Union. All rights reserved.

Daux, V., Michelot-Antalik, A., Lavergne, A., Pierre, M., Stievenard, M., Bréda, N., Damesin, C. (2018). Comparisons of the performance of ^{13}C and ^{18}O of *F. sylvatica*, *P. sylvestris* and *Q. petraea* in the record of past climate variations. *Journal of Geophysical Research: Biogeosciences*. . DOI : 10.1002/2017JG004203

Biogeosciences . . DOI : 10.1002/2017JG004203

Abstract

Climate reconstructions in temperate Europe have been widely based on oak species.

However, other co-occurring species, largely distributed in Europe, may be used for

recording climate variability. In this paper, we documented the inter-trees and inter-species

variations over 1960-2007 of oxygen and carbon isotopic compositions in ring cellulose of *F.*

sylvatica, *P. sylvestris* and *Q. petraea* co-occurring in the Fontainebleau forest (France). Our

results indicated that large levels of series replication (11 trees on average) were required to

generate isotopic mean series representative of the populations. We calculated mean isotopic

ratios in pine higher than in the deciduous species, and hypothesized that these contrasts

resulted from differences in stomatal conductance, phenology and canopy structure, and, for

oxygen, also in water uptake depth and isotopic exchange rate. We found that $\delta^{18}\text{O}$ and $\delta^{13}\text{C}$

chronologies were significantly correlated to one another in the three species and responded

primarily to air moisture and T_{max} , which indicated that stomatal conductance was an

important driver of changes in both types of records. We determined that the correlations

were strong with the May to July climate variables in *F. sylvatica*, and with the July and

August ones in *Q. petraea* and *P. sylvestris*. We showed that the oxygen records were

systematically more coherent than those of carbon. This study demonstrated that $\delta^{18}\text{O}$, and to

a lesser extent $\delta^{13}\text{C}$, from the three different species are reliable proxies for reconstructing

past hydroclimatic variations in Europe.

1. Introduction

When they are datable and responsive to climate variations, tree ring chronologies are very useful proxies for reconstructing past climate variations. Trees able to provide the most sensitive ring-width chronologies are found at the distribution limit of forest ecosystems, where their growth is constrained by one factor (typically temperature or precipitation; e.g. Schweingruber, 1988). These conditions are found at high latitudes, in mountainous areas or in arid and semi-arid areas. As a result, local to hemispheric temperature reconstructions based on ring-width are weighted towards high latitudes and elevations. Climate studies based on tree-rings isotopic chronologies have frequently been conducted in the same environments as those relying on ring width. For instance in Europe, of the eighteen pluri-centennial climate reconstructions based on tree ring isotopes, six were built from trees located beyond the Arctic Circle (Gagen et al., 2011, 2011; Hiltunen et al., 2009; Loader et al., 2013a; Young et al., 2010) and six from trees living above 800 m of elevation (Esper et al., 2010; Hafner et al., 2014; Kress et al., 2010; Lipp et al., 1991; Reynolds-Henne et al., 2007). Only six are located in temperate locations at low elevation (<800m) in Austria (Haupt et al., 2011), Scotland (Loader et al., 2008), England (Rinne et al., 2013) and France (Etien et al., 2008; Labuhn et al., 2016; Masson-Delmotte et al., 2005). Yet, as already noted by Cernusak and English (2015), there is a strong potential for producing stable isotope chronologies responsive to climate throughout the geographical distributions of forests. The frequent location of isotopic studies at the edge of the trees' distribution may be motivated by the need to find old individuals. Indeed, long-lived trees growing slowly are more likely to occur at the environmental margin of their species range where management is absent (e.g. Black et al., 2008; Larson, 2001). Therefore, the probability to find old trees may be larger in stressful non-managed sites than in the optimal habitat with heavy management.

The studies performed in Europe in temperate areas at low altitude have all been conducted on pedunculate and sessile oak (*Quercus robur* and *Quercus petraea*). Both oaks are long-lived trees (up to 600 years), widespread from southern Scandinavia to the northern part of the Iberian Peninsula (between ca. 40° and 60° N; Fig. 1; Di Filippo et al., 2015; Eaton et al., 2016). For centuries, their woods have been used for timber-framed building. Because timber rotation periods in managed oak forests are about 130-160 years, living individuals older than 200 years are uncommon. Consequently, except for the dendro-isotopic records produced by Loader et al. (2008), which are based only on old living individuals, the long European series were developed by stacking living woods and beams from historical structures. For dendroclimatic studies, living trees are selected according to criteria (about status, micro-environment, etc; Schweingruber et al., 1990) which application ensures certain homogeneity of the sampling. When dealing with historical, archaeological or sub-fossil woods, these criteria cannot be applied and the sampling may therefore be less homogeneous and include trees grown in a larger range of environmental conditions.

In this study, we explored the potential of two tree species, a broad-leaved one, European beech (*Fagus sylvatica*) and a coniferous species, Scots pine (*Pinus sylvestris*), in comparison with the more widely used oak (*Quercus petraea*), for producing isotope-based climate reconstructions in European temperate areas. These two species were investigated because: 1) they are largely distributed over Europe, from Sicily to southern Norway for *Fagus sylvatica*, and all the way across Eurasia for *Pinus sylvestris* (Fig.1; Houston et al., 2016), 2) they have been diversely managed and used for centuries, and historical samples exist which could be used to extend chronologies built from living trees. Sessile oak, European beech and Scots pine are co-occurring species in the Fontainebleau forest (South Paris, France), growing on monospecific stands close to one another, in the same climatic area. We exploited this opportunity to document inter-trees and inter-species variability of

oxygen and carbon isotopic compositions in beeches, pines and sessile oaks growing together. The stands of the forest exhibit a variety of types and available water capacities (AWC). We hypothesized that the response of oxygen and carbon isotope compositions of trees to climate variations may differ according to the AWC of the soil on which they grow (a lower AWC being more likely to generate drought stress inducing in turn stomatal closure and a consequential increase of $\delta^{18}\text{O}$ and $\delta^{13}\text{C}$ in tree-rings). Therefore, for each species, we sampled 2 stands with soils of different types and of the most contrasted possible AWC in order to approach the diversity of tree-environments that may be included when sampling historical woods. From our results, we inferred the proper sample size to generate isotopic mean series representative of the population for each species. We then tested the performance of $\delta^{13}\text{C}$ and $\delta^{18}\text{O}$ in the three species as climate recorders by studying the differences and coherences between ring isotopic chronologies over 1960-2007 and the responses of the isotopic signals to several climatic variables.

2. Materials and methods

2.1. Sampling site

The experimental site covers a 170 km² area, 60 km southeast of Paris, France (longitude 2.40°E, latitude 48.25°N, elevation 40-100 m; Fig. 1). The bedrock is composed of the Oligocene Fontainebleau sand unit, covered from place to place by sandstone and limestone. The soil texture is dominated by sand mixed with loam and clay. Fontainebleau has a typical attenuated oceanic climate with a regular year-round distribution of precipitation (between 48 and 65 mm/month). Over 1960-2007, the annual total precipitation was 754 mm and the mean annual temperature 10.9°C.

The studied forest, which is managed by the French National Forest Office (ONF), is composed mainly of sessile oaks (*Quercus petraea* (Matt.) Liebl.), European beeches (*Fagus sylvatica* L.) and Scots pines (*Pinus sylvestris* L.). Three monospecific stands per species, located in the southern part of the forest, were chosen and sampled in April 2008 (Fig. 1; Tab. 1). They were selected for contrast in soil type and hence fine roots distribution and actual water capacity in order to represent the variability observed in the forest. In each stand, 8 dominant healthy trees were cored at breast height. The trees were chosen mature to minimize possible age effects on the isotopic composition. The growth response of the three species to climatic variations and soil water deficits was presented in Michelot et al. (2012a). Two stands per species were chosen for the isotopic analyses, leading to a total of 16 trees analysed per species.

2.2. Analytical procedure

Tree-ring widths were measured using a digitising tablet connected to a micro-computer and the tree-ring program SAISIE. Details of the procedure can be found in Michelot et al. (2012a). Ring cutting was done using a scalpel under binocular magnifier. For *Q. petraea*, early and latewood were separated, and only the latewood, which is mainly built with the current year photosynthates, was processed further. Early and latewood were not separated in *F. sylvatica* and *P. sylvestris* samples. For *F. sylvatica*, which is a diffuse-porous species, these two parts were not distinguishable. For *P. sylvestris*, the latewood widths were too narrow to provide sufficient cellulose in the latewood alone. In the Fontainebleau forest, during the 2009 growing season, *F. sylvatica* radial growth began just after budburst and did not depend on stem non-structural carbohydrates but on leaf photosynthesis, while *Q. petraea* growth started prior to photoassimilates synthesis. *P. sylvestris*, whose needles are photosynthetically active in winter, used essentially newly formed assimilates from the start of the radial growth (Michelot et al., 2012b). We hypothesized that these specific dynamic

uses of non-structural carbohydrates have been stable over the studied period. Therefore, the celluloses extracted from *Q. petraea* late wood and *F. sylvatica* and *P. sylvestris* total wood were built very likely mainly with current year photosynthates.

For the last 14 years of the sampling period (1994-2007), each single tree was analysed, while for the 1960-1993 interval, the annual shavings of the 8 trees of a given stand were pooled. Samples were milled with a 0.08 mm sieve to ensure their homogeneity.

Isotopic analyses were performed on α -cellulose extracted from wood according to the SOXHLET method elaborated by Green (1963) and modified by Leavitt and Danzer (1993). The analyses were corrected using an internal laboratory reference of cellulose (Whatmann® CC31), which had been inter-compared by the European laboratories involved in the ISONET European project (-25.54‰ for $\delta^{13}\text{C}$ and $+31.85\text{‰}$ for $\delta^{18}\text{O}$; Boettger et al., 2007).

The $\delta^{18}\text{O}$ values were determined by pyrolysis of the α -cellulose to CO with a TC/EA coupled with a Finnigan MAT252 mass spectrometer (at LSCE, Gif/Yvette, France). The measurements of $\delta^{13}\text{C}$ were performed by combusting the α -cellulose to CO₂ in a Carlo Erba 1500 elemental analyser (CE Instruments, Milan, Italy), interfaced to an optima IRMS (Micromass Ltd., Manchester, UK) (at IBP, Gif/Yvette, France). The analytical errors (lower than $\pm 0.10\text{‰}$ for $\delta^{13}\text{C}$ and $\pm 0.25\text{‰}$ for $\delta^{18}\text{O}$) were monitored constantly by measurements of reference material after every 5th sample and replicates (2-4 times) analyses of individual cellulose samples.

Due to the rise of ^{13}C -depleted atmospheric CO₂ induced by fossil fuel burning and deforestation since industrialization (the Suess effect; Keeling, 1979), the $\delta^{13}\text{C}$ ratio of atmospheric CO₂ has decreased of around 1.1‰ over the 1960-2007. We took into account latitudinal and seasonal fluctuations of $\delta^{13}\text{C}$ in atmospheric CO₂ to obtain a correction suitable for the Northern Hemisphere mid-latitude growing season (Masson-Delmotte et al.,

2005; M. Leuenberger calibration data, EU project ISONET) and produced corrected $\delta^{13}\text{C}$ record ($\delta^{13}\text{C}_{\text{cor}}$ hereafter).

2.3. Inter-tree and inter-species comparisons

All the calculations performed in this paper were done using the *R* environment or the Excel-program. The coherence of the isotopic records within each species was evaluated using the mean value of the standard deviations (\overline{SD}), and the mean Pearson coefficient (\overline{R}) of the pairwise correlations between the individual isotopic series over 1994-2007.

To determine the level of replication required to yield representative mean isotopic signals, the Expressed Population Signals (EPS) and the mean confidence intervals (CI) were determined.

EPS were calculated as follows (Wigley et al., 1984) :

$$\text{EPS} = \overline{R} / (\overline{R} + (1 - \overline{R}) / N) \quad (1)$$

where *N* is the number of single series. As the average of single series is thought to reasonably portray the true chronology when EPS is superior to 0.85 (Wigley et al., 1984), we determined the level of replication for which EPS is over this threshold ($N_{\text{EPS}>0.85}$ in Tab. 2).

To assign uncertainty estimates associated to a level of replication *n* ($3 \leq n \leq 13$), we performed the following calculations (Fig. 2): we drew 100 subsamples of *n* single ring measurements without replacement, for each of the 14 years of the 1994-2007 interval. The random draw thus produced 1400 subsamples. We computed the confidence interval around the mean (mean \pm CI) for each subsample following equation (2):

$$\text{CI} = [t \times \text{SD} / (n^{0.5})] \quad (2)$$

where *t* is the two tailed Students' *t*-value, at 90% or 95% confidence.

We then calculated the average of the confidence intervals ($\overline{\text{CI}}$). The whole calculation was repeated for each *n* and for each species.

This method was inspired from Loader et al. (2013b) but differed from it by the sampling strategy. Indeed, in Loader et al. (2013b)'s study, the uncertainties in the means were determined using isotopic measurements performed on a large number of trees (100) on a single year. Here, they are estimated from a more limited number of trees (16) but over several years (14). Our approach took into account a larger range of climatic conditions but probably a smaller variety of tree environments (soil depth, nature, etc). Loader et al. (2013b) calculated the mean value and CI of a population of 1000 randomly sampled single ring measurements, at different levels of replication. Here, as the sampling covered several years, with different climatic conditions reflected by a variety of isotopic compositions, this approach could not be applied. While Loader et al. (2013b) calculated the actual CI of a population of subsamples, we calculated the mean value of the theoretical CI of each subsample (90 and 95% CI, with t-distribution multiplier). Therefore, our results are not fully comparable. The levels of replication necessary to get $CI < 0.5\%$ are reported in Tab. 2.

For the 1994-2007 period, stand and species chronologies were obtained by averaging individual records. Over 1960-1993, the stand chronologies were prolonged using pooled samples, and the species chronologies were produced by averaging stand chronologies.

According to the results of the Shapiro-Wilks tests, no significant departure from normality (at least at the 5% threshold) was found for any of these resulting stand and species chronologies. The mean levels of the chronologies over 1960-2007 were compared to one another by applying F-tests of equality of variances and Student's t-test on the mean.

We considered that extreme values of the isotopic records were at least ± 1.6 SD from the mean (~10% of the data).

2.4. Climate data

Correlation functions of specific tree-ring $\delta^{18}\text{O}$ and $\delta^{13}\text{C}$ chronologies were computed with monthly minimum, maximum and mean temperature (T_{\min} , T_{\max} , T_{mean}), mean relative humidity (RH), global radiation (GR), potential evapotranspiration (computed Turc, PET) and precipitation (P) using monthly-averaged daily data recorded by Météo-France at the Melun-Villaroche (30 km north of Fontainebleau) and Fontainebleau (for precipitation) stations over the 1960-2007 period. Correlations with climate variables averaged over two to six consecutive months were also calculated. Meteorological extreme values were identified in the same way as the isotopic ones.

Vapour pressure deficit (VPD) was calculated following:
$$\text{VPD (kPa)} = e_s \times \left(1 - \frac{\text{RH}}{100}\right)$$

(3)

with e_s , the vapour pressure saturation as follows (Tetens, 1930):

$$e_s = \left[0.611 \times e^{17.27 \times T / (237.3 + T)}\right] \quad (4)$$

T_{\max} was used for the calculation of VPD.

3. Results

Although the two stands selected for each species had different soils and AWC, the stand chronologies of each species showed similar distributions, variances and means (Fig. 3; Tab. S1). These inter-stands similarities suggest that the differences in soil types and AWC were not key factors influencing the isotopic compositions within a species, at least in the limited range of variations which does exist in the Fontainebleau forest. Distinctions at stand levels not being relevant here, we chose to document comparisons and correlations between individuals and between species.

3.1. Intra-species variabilities

Over 1994-2007, the specific mean levels of the carbon and oxygen isotopic compositions ranged from -23.41 to -22.58 ‰ and from 31.04 to 32.61‰ respectively (Tab. 2; Fig. 3). The associated standard deviations ranged from 0.59 to 0.94 and from 0.52 to 0.71, the larger ones being obtained for carbon in *F. sylvatica* and for oxygen in *P. sylvestris*. The mean pairwise correlation coefficients ranged from 0.28 to 0.67. They were systematically larger for the $\delta^{18}\text{O}$ than for the $\delta^{13}\text{C}_{\text{cor}}$ series. For both carbon and oxygen, the larger \bar{R} values were obtained in *Q. petraea*. According to the calculation of $N_{0.85}$, the minimum number of trees needed for developing a representative chronology ranges from 3 to 6 trees for $\delta^{18}\text{O}$ and from 5 to 14 trees for $\delta^{13}\text{C}$. Even larger numbers of trees were needed in order to satisfy the requirement of $\text{CI} < 0.5\%$ (e.g. more than 11 trees for $\delta^{13}\text{C}$ for *F. sylvatica*, and up to 10 for $\delta^{18}\text{O}$ for *P. sylvestris*; Tab. 2; Fig. 4).

3.2. Inter-species comparisons

For both $\delta^{18}\text{O}$ and $\delta^{13}\text{C}_{\text{cor}}$, no difference of variances between species were observed (F-test; $p > 0.1$; Tab. 3), except between *Q. petraea* and *P. sylvestris* $\delta^{18}\text{O}$ ($p < 0.001$). The difference of means were significant (t-test; $p < 0.001$), except the one of *Q. petraea* and *P. sylvestris* $\delta^{13}\text{C}_{\text{cor}}$ ($p = 0.068$). The inter-species difference of mean values was larger for $\delta^{18}\text{O}$ than for $\delta^{13}\text{C}_{\text{cor}}$ (Tab. 3 and Fig. 5).

The specific chronologies showed common features. The three $\delta^{18}\text{O}$ chronologies exhibited step increases in the late 1980s. The $\delta^{13}\text{C}$ series slightly trended up from 1960 to the mid -1970s and down from the late 1980s - early 1990s to 2007. They depicted consistent inter-annual variations, which were reflected in the strength of their pairwise correlations ($R_{\text{species}} > 0.54$). The strongest correlations were observed between the $\delta^{13}\text{C}_{\text{cor}}$ of *P. sylvestris* and *F. sylvatica* and between the $\delta^{18}\text{O}$ of *Q. petraea* and *F. sylvatica*. The inter-annual

variations of $\delta^{18}\text{O}$ were more similar between species than those of $\delta^{13}\text{C}_{\text{cor}}$ (higher R_{species}). In each species, the $\delta^{13}\text{C}_{\text{cor}}$ and $\delta^{18}\text{O}$ series were positively and significantly correlated to one another (Fig. 3). The strength of the correlation decreased from 0.70 in *F. sylvatica* to 0.60 in *P. sylvestris* and 0.43 in *Q. petraea* ($p < 0.001$).

3.3. Correlations with meteorological variables

Negative correlations were found between oxygen and carbon isotopic variables and P of June for *F. sylvatica* and of August for *P. sylvestris* (Fig. 6; Tab. S2). Positive and in many cases significant relationships were evidenced between tree ring $\delta^{13}\text{C}_{\text{cor}}$ series and July (for *Q. petraea* and *F. sylvatica*) or August (for *P. sylvestris*) GR, VPD, T_{max} and PET. For all species, tree ring $\delta^{18}\text{O}$ were positively correlated with VPD and T_{max} from May to August and negatively with P and RH of the same months, but the correlations were not all significant.

For $\delta^{13}\text{C}_{\text{cor}}$, The strongest correlations were found with the temperature averaged over July-August for *Q. petraea* (T_{maxJA} ; $R = 0.52$; $p < 0.001$), and the precipitation of June-August for *F. sylvatica* and *P. sylvestris* (P_{JJA} ; $R = -0.68$ and -0.71 , resp.; $p < 0.001$). For $\delta^{18}\text{O}$, they were evidenced with the VPD averaged over July-August for *Q. petraea* and *P. sylvestris* (VPD_{JA} ; $R = 0.61$ in both cases; $p < 0.001$) and over June-August for *F. sylvatica* (VPD_{JJA} ; $R = 0.74$; $p < 0.001$). Using these strongly correlated records, we investigated if the meteorological extremes had produced isotopic extremes (Fig. 5). The years with meteorological extremes were : 1976, 1990 and 2003 for T_{maxJA} , VPD_{JA} and VPD_{JJA} (high), 1965 and 1983 for T_{maxJA} (respectively high and low), 1964 and 1976 (low) and 1960, 1981, 1987, 1997 and 2001 (high) for P_{JJA} . In phase with the meteorological extremes, the carbon and oxygen isotopic chronologies exhibited extremely high values in 1976 (three species), in 1987 (*P. sylvestris* and *F. sylvatica* $\delta^{18}\text{O}$) and in 1990 (*F. sylvatica* and *P. sylvestris*). The extremely high value of rain in 1960 and of temperature in 1983 were echoed by low and high extremes

respectively in the oak $\delta^{13}\text{C}$. While the values of T_{\max} and VPD were extremely high in 2003, neither the carbon, nor the oxygen isotopic ratios of any of the three species were extreme.

4. Discussion

4.1. How many trees are necessary for developing robust paleoclimate reconstructions?

The results presented above suggest that a reliable mean isotopic value could be established when a rather large number of trees was sampled (11 trees on average; 7 for $\delta^{18}\text{O}$ in *Q. petraea* to more than 13 for $\delta^{13}\text{C}$ in *F. sylvatica*). In paleoclimate studies, due to the cost and time needed for processing samples, a more restricted number of trees is generally used for constructing isotopic chronologies. Indeed, based on the $\text{EPS} > 0.85$ criterion, a number of 4 trees has often been considered satisfactory to develop representative isotope records (e.g. Holzkämper et al., 2008; Leavitt & Long, 1984; McCarroll & Pawellek., 1998; Rebetez, et al., 2003). It was, for instance, the standard in the European Union-funded ‘ISONET’ project as reflected in some of the resulting publications (e.g. Hiltunen et al., 2009; Masson-Delmotte et al., 2005; Reynolds-Henne et al., 2007; Rinne et al., 2013; Treydte et al., 2007). However, as stressed for instance by McCarroll and Pawellek (1998), Daux et al. (2011) and Loader et al. (2013b), the EPS metric of replication is based only on the strength of the correlations between trees. Even when the correlation is strong enough for the EPS to be superior to 0.85, the level of replication may be too low to capture a site mean isotopic signal. As long chronologies are usually produced by joining different cohorts, a robust low-frequency signal can be obtained only if reliable mean isotopic values with acceptable CI are established for each year of the record. Therefore, both EPS and CI metrics should be considered to define the minimum number of trees needed. For *P. sylvestris*, Loader et al. (2013b) calculated that the CI around the mean (at 95%) can be expected to be $\pm 0.68\%$ for both carbon and oxygen isotopes for a sample size of 10. Here, we obtain CI

values that were somewhat smaller (0.42‰ and 0.50‰) for the same number of trees. Due to the different methodologies (i.e. sampling of several years/single year) our calculations are not fully comparable but both agree with the conclusion that higher levels of replication than those frequently adopted using only EPS metric must be considered if a representative regional signal is to be attained and used to reconstruct paleoclimates.

For *F. sylvatica* and *Q. petraea*, a smaller number of trees was necessary to produce a reliable mean isotope series for oxygen than for carbon, which was reflected by the smaller dispersion around the mean for $\delta^{18}\text{O}$ (e.g. $N_{95\text{CI}<0.5}$, Tab. 2). Regarding the interannual coherence for the three species, the $\delta^{18}\text{O}$ chronologies were more consistent with each other than the $\delta^{13}\text{C}_{\text{cor}}$ ones (see e.g. $N_{\text{EPS}>0.85}$, Tab. 2).

A review of the literature allowed the compilation of 36 pairs of EPS of oxygen and carbon isotopic compositions chronologies ($\text{EPS}_{\delta^{18}\text{O}}$ and $\text{EPS}_{\delta^{13}\text{C}}$; Tab. S3; Fig. S4) from various tree species (mainly coniferous) grown in various environments. $\text{EPS}_{\delta^{18}\text{O}}$ was superior to $\text{EPS}_{\delta^{13}\text{C}}$ in 70% of the cases. In other words, the oxygen isotopic series were more mutually consistent than the carbon ones in most cases, although this result must be considered with caution because of the small size of the database. The oxygen isotopic composition of tree-ring cellulose records the isotopic composition of the source-water of the tree and integrates the response of stomatal conductance to atmospheric water deficit. It is therefore controlled by the source composition and by the VPD (e.g. Barbour et al., 2005; Gessler et al., 2013). The strong relations between the VPD of the growing season and $\delta^{18}\text{O}$ we evidenced for the three species illustrate well these statements. In comparison, $\delta^{13}\text{C}$ records the balance between the stomatal conductance and the photosynthetic rate (e.g. Farquhar et al., 1982). It is thus also partly controlled by VPD through stomatal conductance, and, in addition, by environmental factors like site fertility and light availabilities which influence carboxylation rates and photosynthesis (e.g. Leavitt & Long, 1986; Weitner et al.,

2007). The larger inter-tree variability of the $\delta^{13}\text{C}$ compared to $\delta^{18}\text{O}$, which is observed here and in most studies, very likely reflects the greater sensitivity of carbon discrimination to the microenvironment of the trees. Significant correlations between ring width, which is a spatially-explicit process (e.g. Das, 2012; Aakala et al., 2013), and ring $\delta^{13}\text{C}$ of oaks at inter- (Ponton et al., 2001) and intra-annual scales (Michelot et al., 2011) support the hypothesis of $\delta^{13}\text{C}$ being influenced by competition for resources and individual environmental factors. In particular, the access to light which strongly affects carbon isotopic discrimination (Brienen et al., 2017), may be uneven, even if we have selected dominant trees. Moreover, as proposed by Weitner et al. (2007), microsites variations in soil pH do exist, which may be partly responsible for inter-tree variability in $\delta^{13}\text{C}$. At the sites where the inter-trees consistency of $\delta^{13}\text{C}$ is higher than the one of $\delta^{18}\text{O}$ (30% of the cases; Sup. Mat. S1), trees may have access to different water sources and the supply of water from the surface and from deeper layers may have varied in time and space. This hypothesis cannot be verified in the frame of this study.

Of the three species, *Q. petraea* had the more homogenous population regarding $\delta^{18}\text{O}$ and $\delta^{13}\text{C}$ (taking into account both EPS and CI), whereas the two stands had the most contrasted AWC and leaf area index (LAI; Tab. 1). The reason of this higher homogeneity may lie in the fact that only the cellulose of the late wood was analysed in *Q. petraea*.

4.2. What are the differences and similarities of the isotopic records of *Q. petraea*, *F. sylvatica* and *P. sylvestris*?

Contrary to our expectations, the populations of the two stands of each species, which have grown on soils of different AWC, could not be distinguished by their oxygen and carbon compositions. Possible effects of soil humidity on the isotopic compositions of rings have been hypothesized in other contexts. For instance, in South-Western France, a difference of soil thickness and thus of total water capacity, was invoked for explaining a 0.8‰ difference between two *Quercus* stands (Labuhn et al., 2014). Another example was provided from oaks

from two hydrologically different neighbouring alpine sites (a wet one in a flood plain and a drier one on a ridge) whose $\delta^{18}\text{O}$ and $\delta^{13}\text{C}$ exhibited inter-site offsets of 0.6‰ and 1.1‰ respectively [Danis et al., 2006]. Our results suggest that, at Fontainebleau, the inter-stand differences of AWC were too small for being differentiating factors within a species.

The isotopic signatures of the three species sampled in the Fontainebleau forest were rather coherent with one another ($R_{\text{species}} > 0.54$ for carbon and > 0.74 for oxygen; Tab.3).

Hemming et al. (1988) who studied the $\delta^{13}\text{C}$ of *Q. robur*, *F. sylvatica* and *P. sylvestris* at a site in central England and Saurer et al. (2008) who analysed the variations of both carbon and oxygen isotopes of these and other species over a large area of Switzerland, observed a similar inter-species coherence. In contrast, Reynolds-Henne et al. (2009) found low correlations between the $\delta^{18}\text{O}$ series of oaks, beeches and pines growing at a single location and concluded that local or tree-specific factors influenced $\delta^{18}\text{O}$. However, the small number of trees (2 per species) in this study may be responsible for the lack of inter-species consistency.

Although they varied in a coherent way with time, the isotopic records of the three studied species showed different mean levels. The mean $\delta^{18}\text{O}$ of *P. sylvestris* cellulose was 1‰ higher than the one of *F. sylvatica*, which was 0.6‰ higher than the one of *Q. petraea*. Reynolds-Henne et al. (2009) measured differences about 50% larger (1.5‰ between *P. sylvestris* and *F. sylvatica* and 1‰ between the latter and *Q. robur*). Szczepanek et al. (2006) obtained intermediary results, with a difference between *Q. robur* and *P. sylvestris* of 2.1 ‰. In our study, the offsets in mean $\delta^{13}\text{C}_{\text{cor}}$ levels between species were moderate (over 1960-2007: 0.47‰, $p < 0.001$, between *P. sylvestris* and *F. sylvatica* and 0.23‰, not significant, between *P. sylvestris* and *Q. petraea*, the differences being twice larger over 1994-2007). These results are in contrast with those of Hemming et al. (1998) and Szczepanek et al. (2006) who reported 2 to 2.5‰ difference between the cellulose $\delta^{13}\text{C}$ of *P. sylvestris* on one

hand, and *Q. robur* and *F. sylvatica* on the other hand. According to Ponton et al. (2001), $\delta^{13}\text{C}$ in *Q. robur* is about 1‰ lower than in *Q. petraea* when growing in mixed stands. Therefore, the difference between *Q. petraea* and *P. sylvestris* is expected to be smaller than the one between *Q. robur* and *P. sylvestris*, which is more consistent with our observations, although the differences in mean levels that we calculated are still smaller. So, we cannot fully reconcile our $\delta^{18}\text{O}$ and $\delta^{13}\text{C}$ results with those published previously. It can be noted, however, that we analysed 16 trees per species, while Hemming et al. (1998) and Reynolds-Henne et al. (2009) analysed 2 trees/species and Szczepanek et al. (2006), 4 trees/species. The mean values we obtained are thus more robust and more representative of population means. Using our data, we calculated the ranges of mean $\delta^{13}\text{C}$ and $\delta^{18}\text{O}$ values per species for replications of 2 to 13 trees (100 draws with replacements; Fig. 4). As expected, for both $\delta^{13}\text{C}$ and $\delta^{18}\text{O}$, the ranges of mean values were larger when the replications were lower. The maximum possible differences between the mean values of *Q. petraea* and *P. sylvestris*, for replications of 2 to 4, were about 2‰. This calculation confirms that inter-species isotopic differences as large as those obtained in previous studies can be due to a low replication. Moreover, it is worth noting that the ranges of variations of the mean ratios of *Q. petraea*, *F. sylvatica* and *P. sylvestris* largely overlapped (Fig. 4). Thus, the differences between the mean ratios of series with low levels of replication could even be opposite to the differences between the mean ratios of the populations. For instance, for a replication inferior to 10, the mean $\delta^{13}\text{C}$ calculated for oak could be higher than the one calculated for pine. Within the context of the preceding discussion, these results re-emphasize the importance of an adequate sampling replication prior to drawing conclusions about population means.

The higher values of $\delta^{13}\text{C}_{\text{cor}}$ and $\delta^{18}\text{O}$ in *P. sylvestris* compared to the deciduous species may reflect specific differences in stomatal conductance, canopy structure and phenology, and for $\delta^{18}\text{O}$, also differences in water uptake depth and post-photosynthetic oxygen exchanges.

- *P. sylvestris*, as a gymnosperm, has higher intrinsic water use efficiency (iWUE, i.e. the ratio of photosynthetic carbon uptake (A) to stomatal conductance (g_s); e.g. Leonardi et al. 2012) than the two deciduous trees. In accordance with this general rule, in this study, the mean values of iWUE of *P. sylvestris*, *F. sylvatica* and *Q. petraea* are equal to 99.5, 97.2 and 92.5 $\mu\text{mol CO}_2\cdot\text{mol}^{-1}\text{H}_2\text{O}$ respectively (iWUE calculation performed as in Lavergne et al., 2017). A larger iWUE can result from either reduced g_s or increased A (Scheidegger et al., 2000). As conifers usually have lower A than broadleaved (Reich et al., 1995; Lusk et al., 2003), the inter-species offsets of $\delta^{13}\text{C}$ are more likely due to differences in g_s . A reduced g_s , which promotes evaporative isotopic enrichment (Grams et al., 2007; Scheidegger et al., 2000), is also consistent with pine having the higher $\delta^{18}\text{O}$.

- The canopy surface of *P. sylvestris*, measured by the leaf area index (LAI), was smaller than those of the two other species (on average: 3.8 versus 5.8; Tab. 1), which implies that *P. sylvestris* have intercepted less incident rainfall than the deciduous, allowing more rain to reach the soil at each rain event. However, *P. sylvestris* as an evergreen conifer maintains interception losses throughout the year, including in winter, when water infiltration in soil is higher. Therefore, the proportion of annual rainfall lost by interception for the pine stand may have been superior to the one for deciduous. It was the case in the study conducted by Calder et al. (2003) who reported 25 to 45% of loss by interception in pine stands compared with 10-25% in oak stands. A lower LAI also induces a higher evaporation of soil water (Granier et al., 1999; Baldocchi and Ryu, 2011). The combination of less water flowing to the groundwater and more evaporation induces decreased soil moisture, which may lead to

an increased water stress, which, in turn, can induce a reduced stomatal conductance (e.g. Tuzet et al., 2003) yielding increased $\delta^{18}\text{O}$ and $\delta^{13}\text{C}$ in carbohydrates. Therefore, a possible cause for the difference of oxygen and carbon isotopic levels between *P. sylvestris* and the deciduous species may lie in their canopy structure.

At Fontainebleau, in 2009, the growing season was longer for *P. sylvestris* than for the two deciduous species; it started earlier and ended later. In particular, it extended over the whole August month, a period when transpiration may have been important, while *F. sylvatica* and *Q. petraea* had stopped growing by mid and early August respectively (Michelot et al., 2012b). As increasing evaporative demand increases ^{18}O enrichment in organic matter (Farquhar et al., 2007), the cellulose formed in *P. sylvestris* at the end of the growing season may have been more enriched and this effect may have contributed to the higher $\delta^{18}\text{O}$ in the whole ring of this species. Intra-ring $\delta^{13}\text{C}$ measurements were conducted in oaks, beeches and pines of the Fontainebleau forest in 2009 (Michelot, 2011). They revealed an increase of the cellulose $\delta^{13}\text{C}$ of ~ 2.5 ‰ from April to July-August in *P. sylvestris*, while such a trend was less marked or absent in *F. sylvatica* and *Q. petraea*. Such a ^{13}C enrichment of the cellulose formed at the end of the growing season can have driven the value of the whole ring cellulose of pine upwards. Year 2009 was a rather dry year (147 mm over June-August) and the growing season was shorter than it usually is (Michelot et al., 2011). Therefore, to confirm the hypothesis of a phenological effect on the carbon and oxygen isotopic compositions of the rings, a several-year phenological monitoring accompanied by intra-ring isotopic analyses would be necessary.

Oak, and to a lesser extent beech, are supposed to use deeper sources of water than pine (Leuschner et al., 2001). Indeed, when water availability decreases, these species (and oak more than beech) may be able to use water from deeper soil layers by increasing their root-to-shoot ratio and fine root production (Osonubi & Davies, 1981; van Hees, 1997). As

evaporation at the soil surface cause ^{18}O -enrichment of the water decreasing exponentially along the upper meter or so (Allison & Hughes, 1983; Darling, 2004; Darling & Bath, 1988; Hsieh et al., 1998), access to deeper water may induce lower cellulose $\delta^{18}\text{O}$ in *Q. petraea* and *F. sylvatica* than in the more superficially rooted *P. sylvestris*. Such a depth difference in source water between oak (*Q. aquifolioides*) and pine (*P. tabulaeformis*) was evidenced, for instance, by Duan et al. (2008). At the sites sampled in our study, the fine root depth depended more on soil type than on tree species, with larger inter-stand than inter-species contrasts (Tab. 1), which *a priori* does not support the hypothesis of a root depth effect. However, the distribution of water uptake may not be a function of root distribution only and the three species may not have the same ability to tap water at different levels. Indeed, the decreasing strength of the correlation between $\delta^{18}\text{O}$ and $\delta^{13}\text{C}$ from *F. sylvatica* and *P. sylvestris* to *Q. petraea*, which cannot be explained by a decreasing g_s (see paragraph on iWUE), may reflect an enhanced ability of the oak species to switch its depth of water uptake to soil levels with higher water potential. Such increased variability in source water could induce $\delta^{18}\text{O}$ variations in tree-ring decoupled from the effect of evaporative fractionation mediated by g_s , and therefore decoupled from the variations of $\delta^{13}\text{C}$. To sum up, different mean depth of water uptake and contrasted ability to switch from a source water level to another may explain some of the inter-species isotopic differences (in mean level and strength of the $\delta^{18}\text{O}$ - $\delta^{13}\text{C}$ correlation) noted in this study. However, these assumptions cannot be tested with our data.

Finally, the fraction of oxygen exchange between carbohydrates and water at the site of cellulose synthesis may vary from a species to another (e.g. Sternberg and Ellsworth, 2011). A lower fraction induces a higher $\delta^{18}\text{O}$ in cellulose and relatively small changes in the exchange rate have a significant impact on the isotopic composition (e.g. 10% change induced 1.9‰ variation in the $\delta^{18}\text{O}$ of some cellulose according to Keel et al., 2016).

Song et al. (2014) and Li et al. (2014) both suggested that the ^{18}O enrichment of pine species compared to oak species (*Pinus rigida* versus *Quercus velutina* and *Quercus prinus* and *Pinus densiflora* versus *Quercus serrate* and *Quercus variabilis*) could reveal a lower fraction of oxygen exchange. Such a variable proportion of isotopic exchange may also have contributed, in part, to the inter-specific differences of mean isotopic levels observed here.

4.3. Which environmental and climatic variables are recorded in the tree-ring $\delta^{18}\text{O}$ and $\delta^{13}\text{C}$ of the three species?

The responses to climate of the three species were shown to be coherent and valuable. However, slight specific differences and a mismatch between climatic extremes and isotopic series in 2003 were evidenced. In this section, the causes of the differences and mismatch are investigated. Then the performance of tree-ring variables (width, $\delta^{13}\text{C}$ or $\delta^{18}\text{O}$) as climate proxies are discussed.

The strongest correlations between isotopic records and climate variables occurred during summer months, likely underlining the importance of the growing period (May-August). The strength of the response to climate nevertheless differed from one species to another and some of the observed dissimilarities may be explained, at least partly, by phenology. For instance, significant correlations with August climate variables were observed mainly for *P. sylvestris*, which, as already mentioned, has the longest growing season extending until September. This result is in accordance with Michelot et al. (2012a)'s, who evidenced the influence of the climate in August on *P. sylvestris* growth at Fontainebleau. Strong correlations with June variables were observed for *F. sylvatica* series, probably because the maximum growth rate of this species occurred during this month (Michelot et al., 2012a). For *Q. petraea*, only latewood, which begins to form during late June, was analysed: this may explain that the correlations of the isotopic chronologies with May and June climate records were not significant.

The comparison of the isotopic and meteorological extremes revealed some inconsistency. The extremely high values of summer VPD in 1976, 1990 and 2003, should have induced extremely high $\delta^{13}\text{C}$ and $\delta^{18}\text{O}$ in tree-rings. Such extremes were measured in the rings formed in 1976 and 1990 actually, but not in those produced in 2003. An important difference between the two former years and the latter lies in the distribution of precipitation. Indeed, the precipitation cumulated from previous October to August was low at Fontainebleau in 1976 and 1990 (357 mm and 455mm respectively), while it was 700 mm in 2003. Therefore, the soil water was very likely less critically low in summer 2003 than during the summers of the other two years. While we have identified a meteorological extreme with no isotopic counterpart, we did not evidenced isotopic extremes not related to extreme meteorological values (exceeding at least 1.5 SD).

In agreement with a control of $\delta^{13}\text{C}$ and $\delta^{18}\text{O}$ by June-August meteorological conditions, the tree growth of the three species was shown to be sensitive mainly to the precipitation of the current growing season (Michelot et al., 2012a). The correlations of the isotopic chronologies with precipitation records were stronger for *Q. petraea* and *P. sylvestris*, and a little weaker for *F. sylvatica*, than those involving tree-ring width (TRW; $R=0.57$, $p<0.05$ with P_{May} and P_{July} ; Michelot et al., 2012a). In addition, for the three species while TRW showed weak or insignificant relations with temperature, summer temperature has strongly influenced both isotopes. These findings showed that stable isotopes are better climate proxies than TRW at the Fontainebleau sites. They are in line with Loader et al. (2008)'s and Young et al. (2012)'s conclusions about the usefulness of isotopes in temperate and maritime areas where the development of robust paleoclimate reconstructions from TRW is challenging.

Of the three species, *F. sylvatica* showed the strongest correlations with climate variables. Regarding growth, it is also widely reported as the most sensitive to climatic conditions (Michelot et al., 2012a; Weemstra et al., 2013). This responsive species has therefore a strong potential for reconstructing past variations of air moisture and temperature using either stable isotopes, or ring width series. However, the larger homogeneity of *Q. petraea* population in terms of ring isotopic composition if confirmed in further studies, and the more widespread use of *Q. petraea* as timber wood gives an asset to this species for reconstructing the past variations of these variables on periods exceeding two or three centuries.

The strong correlations between oxygen and carbon isotopic records of *Q. petraea*, *F. sylvatica* and *P. sylvestris* and summer temperature and air moisture (VPD, RH, PET) indicated that all these climate variables are potential targets for long-term reconstructions. While VPD plays a critical role in controlling ecosystem fluxes of water and carbon (Novick et al., 2016; Sulman et al., 2016), its long-term changes have not been documented (to our knowledge only one reconstruction by Liu et al., 2017). Our results thus open the door to new VPD-based environmental reconstructions in temperate areas.

5. Conclusion

The study of the oxygen and carbon isotopic compositions of the ring cellulose of *Q. petraea*, *F. sylvatica* and *P. sylvestris* demonstrated that large samples of trees (11 in average) are required to obtain representative regional signals, to produce reliable mean $\delta^{13}\text{C}$ and $\delta^{18}\text{O}$ values for inter-site and inter-species comparisons, and to develop robust paleoclimate reconstructions. For both carbon and oxygen isotopes, the standard value of 4 trees is too low. Only if a unique and continuous cohort of trees with strongly correlated isotopic signals is used (high EPS), might such a low sample depth be satisfactory.

In the Fontainebleau forest, the isotopic chronologies of the three co-occurring species showed different mean levels, although they varied in a coherent way with time. The $\delta^{13}\text{C}$ and $\delta^{18}\text{O}$ were higher in the gymnosperm than in the deciduous angiosperms. A lower stomatal conductance, a higher rainfall loss and a longer growing season may be responsible for the inter-species isotopic differences. A lower rate of isotopic exchanges with xylem water, may also concur to the higher $\delta^{18}\text{O}$ in *P. sylvestris*. The oxygen and carbon isotopic records were significantly correlated to one another in the three species and responded to air moisture (VPD, RH, PET) and T_{max} . These findings suggest that stomatal conductance is an important driver of change for both isotopic ratios. The responses of the three species to climate showed some differences, which may be partly ascribed to their specific phenological patterns. Combining the information obtained from the isotopic composition of different species may be a way to document past climatic variations at the intra-seasonal scale. The oxygen isotopic records were systematically more coherent to one another than those of carbon (at the inter-individual and inter-species scale), which may encourage using $\delta^{18}\text{O}$ rather than $\delta^{13}\text{C}$ for future reconstructions. The three studied species have a good potential to achieve this aim.

Acknowledgments, Samples, and Data

The authors are grateful to the Office National des Forêts (FR) for facilitating the experimental work in the Fontainebleau forest and to Météo-France for providing the climatic data from the Melun-Villaroche (30 km north of Fontainebleau) and Fontainebleau (for precipitation) meteorological stations. They thank F. Gérémia for core sampling and dendrochronological expertise, and N. Etien for technical assistance in sample processing.

This research received support from the AFOCLIM project of the GIS ‘Climat-Environnement-Société’ program (FR). The oxygen and carbon isotopic chronologies of *Q. petraea*, *F. sylvatica* and *P. sylvestris* measured in the frame of this project can be retrieved

at:

<https://files.lsce.ipsl.fr/public.php?service=files&t=9146179ec889dcd80c5d01db3d1b7e68>.

The valuable comments by two anonymous referees greatly contributed to improve the paper.

References

Aakala, T., Fraver, S., D'Amato, A.W., Palik, B.J. (2013) Influence of competition and age on tree growth in structurally complex old-growth forests in northern Minnesota, USA. *For. Ecol. Manag.* 308, 128-135. doi: 10.1016/j.foreco.2013.07.057

Allison, G. B., & Hughes, M. W. (1983). The use of natural tracers as indicators of soil-water movement in a temperate semi-arid region. *J. Hydrol.*, 60, 157–173.
doi:10.1016/0022-1694(83)90019-7

Baldochi, D. D., Ryu, Y. (2011) A synthesis of forest evaporation fluxes - from days to years - as measured by Eddy covariance. In: D.F. Levia et al. (Eds), *Forest Hydrology and Biogeochemistry: Synthesis of past research and future directions*, *Ecol. Stud.* 216, pp 101-116. doi: 10.1007/978-94-007-1363-5_5

Barbour, M. M., Cernusak, L. A., & Farguhar, G. D. (2005). Factors affecting the oxygen isotope ratio of plant organic material. In L. B. Flanagan, J. R. Ehleringer, & D. E. Pataki (Eds.), *Stable Isotopes and Biosphere-Atmosphere Interactions: Processes and Biological Controls* (pp. 9–28). Amsterdam: Elsevier.

Black, B. A., Colbert, J. J., & Pederson, N. (2008). Relationships between radial growth rates and lifespan within North American tree species. *Ecosci.*, 15(3), 349–357.
doi:10.2980/15-3-3149

Boettger, T., Haupt, M., Knöller, K., Weise, S. M., Waterhouse, J. S., Rinne, et al.. (2007). Wood cellulose preparation methods and mass spectrometric analyses of $\delta^{13}\text{C}$, $\delta^{18}\text{O}$, and nonexchangeable $\delta^2\text{H}$ values in cellulose, sugar, and starch: An interlaboratory comparison. *Anal. Chem.*, 79(12), 4603–4612. doi:10.1021/ac0700023

Brienen, R.J.W., Gloor, E., Clerici, S., Newton, R., Arppe, L., Boom, AM et al.

(2017) Tree height strongly affects estimates of water-use efficiency responses to climate and CO₂ using isotopes, *Nature comm.*, 8, 288. doi:10.1038/s41467-017-00225-z

Briffa, K. R. (1984). Tree climate relationships and dendroclimatological reconstructions in the British Isles. University of East Anglia, Norwich, UK.

Calder, I.R., Reid, I., Nisbet, T.R., Green, J.C. (2003) Impacts of lowland forests in England on water resources: application of the hydrological Land Use change model. *Water Resour. Res.* 39(11), 1319. doi: 10.1029/2003WR002042.

Cernusak, L. A. & English, N. B. (2015). Beyond tree-ring widths: stable isotopes sharpen the focus on climate responses of temperate forest trees. *Tree Physiol.*, 35(1), 1–3. doi:10.1093/treephys/tpu115

Darling, W. G. (2004). Hydrological factors in the interpretation of stable isotopic proxy data present and past : a European perspective. *Quat. Sci. Rev.*, 23, 743–770. doi: 10.1016/j.quascirev.2003.06.016

Darling, W. G., & Bath, A. H. (1988). A stable isotope study of recharge processes in the English Chalk. *Journal of Hydrology*, 101, 31–46. doi:10.1016/0022-1694(88)90026-1

Das, A. (2012) The effect of size and competition on rate in old-growth coniferous forests. *Can. J. For. Res.* 42, 1983-1995. doi:10.1139/x2012-142

Daux, V., Edouard, J. L., Masson-Delmotte, V., Stievenard, M., Hoffmann, G., Pierre, M., Mestre, O., Danis, P. A., & Guibal, F. (2011). Can climate variations be inferred from tree-ring variables and stable isotopes from *Larix Decidua*? juvenile effects, budmoth outbreaks, and divergence issue. *Earth Planet. Sci. Lett.* 309, 221–233. doi: 10.1016/j.epsl.2011.07.003

Di Filippo, A., Pederson, N., Baliva, M., Brunetti, M., Dinella, A., Kitamura, K., Knapp, H.D., Shirone, B., Piovesan, G. (2015) The longevity of broadleaf deciduous trees in

Northern Hemisphere temperate forests: insights from tree-ring series. *Front. Ecol. Evol.* 3, 46. doi:10.3389/fevo.2015.00046

Duan, D.-Y., Ouyang, H., Song, M.-H., Hu, Q.-W. (2008) Water sources of dominant species in three alpine ecosystems on the Tibetan Plateau, China. *J. Integr. Plant. Biol.* 50(3), 257-264. doi: 10.1111/j.1744-7909.2007.00633.x.

Eaton, E., Caudullo, G., Oliveira, S., de Rigo, D. (2016). *Quercus robur* and *Quercus petraea* in Europe: distribution, habitat, usage and threats. In J. San-Miguel-Ayanz, D. de Rigo, G. Caudullo, T. Houston Durrant, & A. Mauri (Eds.), *European Atlas of Forest Tree Species*, 160-163. doi:10.2788/038466

Esper, J., Frank, D. C., Battipaglia, G., Büntgen, U., Holert, C., Treydte, K., et al.. (2010). Low frequency noise in $\delta^{13}\text{C}$ and $\delta^{18}\text{O}$ tree ring data: A case study of *Pinus uncinata* in the Spanish Pyrenees. *Glob. Biogeochem. Cycles*, 24(2), 1–11. doi:10.1029/2010GB003772

Etien, N., Daux, V., Masson-Delmotte, V., Mestre, O., Stievenard, M., Guillemin et al. (2008). Summer maximum temperature in northern France over the past century: instrumental data versus multiple proxies (tree-ring isotopes, grape harvest dates and forest fires). *Clim. Change*, 94(3–4), 429–456. doi: 0.1007/s10584-008-9516-8

Farquhar, G. D., O'Leary, M. H., & Berry, J. A. (1982). On the relationship between carbon isotope discrimination and intercellular carbon dioxide concentration in leaves. *Austral. J. Pant Physiol.*, 9, 121–137. doi: 10.1104/pp.106.093278

Farquhar, G. D., Cernusak, L.A., Barnes, B. (2007) Heavy water fractionation during transpiration. *Plant Physiol.* 143, 11-18. doi: 10.1104/pp.106.093278

Gagen, M., McCarroll, D., Jalkanen, R., Loader, N. J., Robertson, I., & Young, G. H. F. (2012). A rapid method for the production of robust millennial length stable isotope tree

ring series for climate reconstruction. *Glob. Planet. Change*, 82–83, 96–103.

doi:10.1016/j.gloplacha.2011.11.006

Gagen, M., Zorita, E., McCarroll, D., Young, G. H. F., Grudd, H., et al. (2011). Cloud response to summer temperatures in Fennoscandia over the last thousand years. *Geophys. Res. Lett.*, 38(5), 1–5. doi:10.1029/2010GL046216

Gessler, A., Brandes, E., Keitel, C., Boda, S., Kayler, Z. E., Granier, et al. (2013). The oxygen isotope enrichment of leaf-exported assimilates—does it always reflect lamina leaf water enrichment? *New Phytol.*, 200(1), 144–57. doi:10.1111/nph.12359

Grams, T., Kozovits, A. R., Häberle, K. H., Matyssek, R., & Dawson, T. E. (2007). Combining $\delta^{13}\text{C}$ and $\delta^{18}\text{O}$ analyses to unravel competition, CO_2 and O_3 effects on the physiological performance of different-aged trees. *Plant, Cell Env.*, 30(8), 1023–1034. doi:10.1111/j.1365-3040.2007.01696.x

Granier, A., Bréda, N., Biron, P., & Villetle, S. (1999). A lumped water balance model to evaluate duration and intensity of drought constraints in forest stands. *Ecol. Modelling*, 116(2–3), 269–283. doi: 10.1016/S0304-3800(98)00205-1

Granier, A., Loustau, D., & Bréda, N. (2000). A generic model of forest canopy conductance dependent on climate, soil water availability and leaf area index. *Ann. Sci. Forest.*, 57, 755–765. doi:10.1051/forest:2000158

Granier, A., Reichstein, M., Bréda, N., Janssens, I. A., Falge, E., Ciais, P., et al. (2007). Evidence for soil water control on carbon and water dynamics in European forests during the extremely dry year: 2003. *Agricult. Forest Meteorol.*, 143(1–2), 123–145. doi:10.1016/j.agrformet.2006.12.004

Green, J. (1963). Carboxymethyl cellulose. In R. Whistler (Ed.), *Methods in carbohydrate chemistry*, vol III. Academic, New York.

Hafner, P., McCarroll, D., Robertson, I., Loader, N. J., Gagen, M., Young, et al. (2014). A 520 year record of summer sunshine for the eastern European Alps based on stable carbon isotopes in larch tree rings. *Clim. Dyn.*, 43(3–4), 971–980. doi:10.1007/s00382-013-1864-z

Haupt, M., Weigl, M., Grabner, M., & Boettger, T. (2011). A 400-year reconstruction of July relative air humidity for the Vienna region (eastern Austria) based on carbon and oxygen stable isotope ratios in tree-ring latewood cellulose of oaks (*Quercus petraea* Matt. Liebl.). *Clim. Change*, (105), 243–262. doi:10.1007/s10584-010-9862-1

Hemming, D. L., Switsur, V. R., Waterhouse, J. S., Heaton, T. H. E., & Carter, A. H. C. (1998). Climate variation and the stable carbon isotope composition of tree ring cellulose: An intercomparison of *Quercus robur*, *Fagus sylvatica* and *Pinus silvestris*. *Tellus B, Chem. Phys. Meteorol.*, 50(1), 25–33. doi:10.1034/j.1600-0889.1998.00002.x

Hilasvuori, E., Berninger, F., Sonninen, E., Tuomenvirta, H., & Jungner, H. (2009). Stability of climate signal in carbon and oxygen isotope records and ring width from Scots pine (*Pinus sylvestris* L.) in Finland. *J. Quat. Sci.*, 24(5), 469–480. doi:10.1002/jqs.1260

Holzkaemper, S., Kuhry, P., & Kultti, S. (2008). Stable isotopes in tree rings as proxies for winter precipitation changes in the Russian Arctic over the past 150 years. *Geochronometria*, 32, 37–46. doi:10.2478/v10003-008-0025-6

Houston Durrant, T., Rigo, D. de, & Caudullo, G. (2016). *Fagus sylvatica* and other beeches in Europe: distribution, habitat, usage and threats. *European Atlas of Forest Tree Species*, 94–95. doi:10.2788/038466

Houston Durrant, T., Rigo, D. de, & Caudullo, G. (2016). *Pinus pinaster* in Europe: distribution, habitat, usage and threats. In *European Atlas of Forest Tree Species*, 126–127. doi:10.2788/038466

Hsieh, J. C. C., Chadwick, O. A., Kelly, E. F., & Savin, S. M. (1998). Oxygen isotopic composition of soil water: quantifying evaporation and transpiration. *Geoderma*, 82, 269–293.

Keel, S.G., Joos, F., Spahni, R., Saurer, M., Weigt, R.B., Klesse, S. (2016) Simulating oxygen isotope ratios in tree ring cellulose using a dynamic global vegetation model. *Biogeosci.* 13, 3869-3886. doi:10.5194/bg-13-3869-2016

Keeling, C. D. (1979). The Suess effect: 13 Carbon- 14 Carbon interrelations. *Environment International*, 2(4), 229–300. doi: 10.1016/0160-4120(79)90005-9

Kress, A., Saurer, M., Siegwolf, R. T. W., Frank, D. C., Esper, J., & Bugmann, H. (2010). A 350-year drought reconstruction from Alpine tree ring stable isotopes. *Glob. Biogeochem. Cycles*, 24, 1–16. doi:10.1029/2009GB003613

Labuhn, I., Daux, V., Pierre, M., Stievenard, M., Girardclos, O., Feron, A., Genty, D., Masson-Delmotte, V., & Mestre, O. (2014) Tree age, site and climate controls on tree-ring cellulose $\delta^{18}\text{O}$: A case study on oak trees from south-western France. *Dendrochronologia* 32, 78-89.

Labuhn, I., Daux, V., Girardclos, O., Stievenard, M., Pierre, M., & Masson-Delmotte, V. (2016). French summer droughts since 1326 CE: a reconstruction based on tree ring cellulose $\delta^{18}\text{O}$. *Clim. Past.* 12, 1101-1117. doi:10.5194/cpd-12-1101-2016

Larson, D. W. (2001). The paradox of great longevity in a short-lived tree species. *Experimental Gerontology*, 36(4–6), 651–673. doi: 10.1016/S0531-5565(00)00233-3

Lavergne, A., Daux, V., Pierre, M., Stievenard, M., Srur, A.M., Villalba, R. (2017) Past summer temperatures inferred from dendrochronological records of *Fitzroya cupressoides* on the eastern slope of the Northern Patagonian Andes. *J. Geophys. Res. Biogeosci.* In press, doi: 10.1002/2017JG003989.

Leavitt, S. W., & Danzer, S. R. (1993). Method for Batch Processing Small Wood Samples to Holocellulose for Stable-Carbon Isotope Analysis. *Anal. Chem.*, 65, 87–89. doi:10.1021/ac00049a017

Leavitt, S. W., & Long, A. (1984). Sampling strategy for stable carbon isotope analysis of tree rings in pine. *Nature*, 311(5982), 145–147. doi:10.1038/311145a0

Leavitt, S. W., & Long, A. (1986). Stable-carbon isotope variability in tree foliage and wood. *Ecology*, 67, 1002–1010. doi: 10.2307/1939823

Leonardi, S., Gentilesca, T., Guerrieri, R., Ripullone, F., Magnani, F., Mencuccini, M., Noije, T.W., Borghetti, M. (2012) Assessing the effects of nitrogen deposition and climate on carbon isotope discrimination and intrinsic water-use efficiency of angiosperms and conifer trees under rising CO₂ conditions. *Glob. Change Biol.*,8, 2925-2844. doi: 10.1111/j.1365-2486.2012.02757.x

Leuschner, C., Hertel, D., Coners, H., & Büttner, V. (2001). Root competition between beech and oak: a hypothesis. *Oecologia*, 126(2), 276–284. doi:10.1007/s004420000507

Li, Z., Nakatsuka, T., Sano, M. (2015) Tree-ring cellulose $\delta^{18}\text{O}$ variability in pine and oak and its potential to reconstruct precipitation and relative humidity in central Japan. *Geochem. J.* 49, 125-137. doi: 10.2343/geochemj.2.0336

Lipp, J., Trimborn, P., Fritz, P., Moser, H., Becker, B., & Frenzel, B. (1991). Stable isotopes in tree ring cellulose and climate change. *Tellus B*, 43, 322–330. doi:10.1034/j.1600-0889.1991.t01-2-00005.x

Loader, N., J., Santillo, P. M., Woodman-Ralph, J. P., Rolfe, J. E., Hall, M. A., Gagen, et al. (2008). Multiple stable isotopes from oak trees in southwestern Scotland and the potential for stable isotope dendroclimatology in maritime climatic regions. *Chem. Geol.*, 252(1–2), 62–71. doi:10.1016/j.chemgeo.2008.01.006

Loader, N. J., Young, G. H. F., Grudd, H., & McCarroll, D. (2013). Stable carbon isotopes from Torneträsk, northern Sweden provide a millennial length reconstruction of summer sunshine and its relationship to Arctic circulation. *Quat. Sci. Rev.*, 62, 97–113.

doi:10.1016/j.quascirev.2012.11.014

Loader, N., Young, G., McCarroll, D., & Wilson, R. (2013). Quantifying uncertainty in isotope dendroclimatology. *Holocene*, 23(9), 1221–1226. doi:10.1177/0959683613486945

Masson-Delmotte, V., Raffalli-Delcerce, G., Danis, P. A., Yiou, P., Stievenard, M., Guibal, F., et al. (2005). Changes in European precipitation seasonality and in drought frequencies revealed by a four-century-long tree-ring isotopic record from Brittany, western France. *Clim. Dyn.*, 24(1), 57–69. doi:10.1007/s00382-004-0458-1

McCarroll, D., & Pawellek, F. (1998). Stable carbon isotope ratios of latewood cellulose in *Pinus sylvestris* from northern Finland: Variability and signal-strength. *Holocene*, 8, 675–684. doi : 10.1191/095968301680223477

Michelot (2011) Croissance et $\delta^{13}\text{C}$ des cernes de trois essences forestières tempérées (*Fagus sylvatica*, *Quercus petraea* et *Pinus sylvestris*) face aux variations climatiques à l'échelle interannuelle et saisonnière. PhD thesis, Univ. Paris Sud, pp202.

<https://www.theses.fr/154674303>

Michelot, A., Eglin, T., Dufrêne, E., Lelarge-Trouverie, C., & Damesin, C. (2011). Comparison of seasonal variations in water-use efficiency calculated from the carbon isotope composition of tree rings and flux data in a temperate forest. *Plant, Cell & Envir.*, 34, 230–244. doi:10.1093/treephys/tps052

Michelot, A., Bréda, N., Damesin, C., & Dufrêne, E. (2012a). Differing growth responses to climatic variations and soil water deficits of *Fagus sylvatica*, *Quercus petraea* and *Pinus sylvestris* in a temperate forest. *Forest Ecol. Manag.*, 265, 161–171.

doi:10.1016/j.foreco.2011.10.024

Michelot, A., Simard, S., Rathberger, C., Dufrêne, E., Damesin, C. (2012b)

Comparing the intra-annual wood formation of three European species (*Fagus sylvatica*, *Quercus petraea* and *Pinus sylvestris*) as related to leaf phenology and non-structural carbohydrate dynamics. *Tree Physiol.* 32, 1033-1043.

Novick, K.A., Ficklin, D.L., Story, P.C., Williams, C.A., Bohrer, G., et al. (2016) The increasing importance of atmospheric demand for ecosystem water and carbon fluxes. *Nature Clim. change* 6(11),1023-1027. doi:10.1038/nclimate3114

Osonubi, O., & Davies, W. J. (1981). Root growth and water relations of oak and birch seedlings. *Oecologia*, 51, 343–350. doi: 10.1007/BF00540904.

Packham, J. R., Thomas, P. A., Atkinson, M. D., & Degen, T. (2012). Biological Flora of the British Isles: *Fagus sylvatica*. *J. Ecol.*, 100(6), 1557–1608. doi:10.1111/j.1365-2745.2012.02017.x

Penman, H. L. (1948). Natural evaporation from open water, bare soil, and grass. *Proc. Royal Soc.*, A193(1032), 120–145. doi: 10.1098/ rspa.1948.0037

Ponton, S., Dupouey, J., Bréda, N., Feuillat, F., Bodénès, C., & Dreyer, E. (2001). Carbon isotope discrimination and wood anatomy variations in mixed stands of *Quercus robur* and *Quercus petraea*. *Plant, Cell & Environment*, 24, 861–868. doi:10.1046/j.0016-8025.2001.00733.x

Rebetez, M., Saurer, M., & Cherubini, P. (2003). To what extent can oxygen isotopes in tree rings and precipitation be used to reconstruct past atmospheric temperature? A case study. *Clim. Change*, 61, 237–248. doi: 10.1023/ A:1026369000246

Reich, P.B., Kloeppel, B.D., Ellsworth, D.S., Walters, M.B. (1995) Different photosynthesis-nitrogen relations in deciduous hardwood and evergreen coniferous tree species. *Oecologia* 104, 24-30. doi: 10.1007/BF00365558.

Reynolds-Henne, C. E., Saurer, M., & Siegwolf, R. T. W. (2009). Temperature versus species-specific influences on the stable oxygen isotope ratio of tree rings. *Trees*, 23(4), 801–811. doi:10.1007/s00468-009-0321-4

Reynolds-Henne, C. E., Siegwolf, R. T. W., Treydte, K. S., Esper, J., Henne, S., & Saurer, M. (2007). Temporal stability of climate-isotope relationships in tree rings of oak and pine (Ticino, Switzerland). *Global Biogeochem. Cycles*, 21(4), 1–12. doi:10.1029/2007gb002945

Rinne, K. T. K., Loader, N. J. N., Switsur, V. R., & Waterhouse, J. S. (2013). 400-year May–August precipitation reconstruction for Southern England using oxygen isotopes in tree rings. *Quat. Sci. Rev.s*, 60, 13–25. doi:10.1016/j.quascirev.2012.10.048

Roden, J. S., & Farquhar, G. D. (2012). A controlled test of the dual-isotope approach for the interpretation of stable carbon and oxygen isotope ratio variation in tree rings. *Tree Physiol.*, 32(4), 490–503. doi:10.1093/treephys/tps019

Roden, J., & Siegwolf, R. (2013). Is the dual-isotope conceptual model fully operational? *Tree Physiol.*, 32(10), 1179–1182. doi:10.1093/treephys/tps099

Saurer, M., Cherubini, P., Reynolds-Henne, C. E., Treydte, K. S., Anderson, W. T., & Siegwolf, R. T. W. (2008). An investigation of the common signal in tree ring stable isotope chronologies at temperate sites. *J. Geophys. Res.*, 113(G40435), 1–11. doi:10.1029/2008jg000689

Scheidegger, Y., Saurer, M., Bahn, M., & Siegwolf, R. (2000). Linking stable oxygen and carbon isotopes with stomatal conductance and photosynthetic capacity: a conceptual model. *Oecologia*, 125, 350–357. doi: 0.1007/s004420000466

Schweingruber, F. H. (1988). *Tree rings: basics and applications of dendrochronology*. Dordrecht: Kluwer Academic Press.

Schweingruber, F.H., Kairiukstis, L., Shiyatov, S. (1990). Sample selection. In: Methods of dendrochronology. Eds: E.R., Cook and L.A. Kairiukstis. Kluwer Academic Publishers. 23-96.

Song, X., Clark, K. S., & Helliker, B. R. (2014). Interpreting species-specific variation in tree-ring oxygen isotope ratios among three temperate forest trees. *Plant, Cell & Environ.*, 37, 2169–2182. doi:10.1111/pce.12317

Sternberg, L. , Ellsworth, P.F.V. (2011). Divergent biochemical fractionation, not convergent temperature, explains cellulose oxygen isotope enrichment across latitudes. *Plos One* 6(11): e28040. doi:10.1371/journal.pone.0028040

Sturm, K., Hoffmann, G., Langmann, B., & Stichler, W. (2005). Simulation of $\delta^{18}\text{O}$ in precipitation by the regional circulation model REMO iso. *Hydrol. Process.*, 19(17), 3425–3444. doi:10.1002/hyp.5979

Sulman, B., Roman, D.T., Yi, K., Wang, L., Philips, R.P., Novick, K.A. (2016) High atmospheric demand for water can limit forest carbon uptake and transpiration as severely as dry soil. *Geophys. Res. Lett.* 43, 9686-9695. doi:10.1002/2016GL069416

Szczepanek, M., Pazdur, A., Pawelczyk, S., Bottger, T., Haupt, M., et al. (2006). Hydrogen, carbon and oxygen isotopes in pine and oak tree rings from Southern Poland as climatic indicators in years 1900-2003. *Geochronometria*, 25, 67–76.

Tetens, O. (1930). Über einige meteorologische Begriffe. *Z. Geophys.*, 6, 297–309.

Treydte, K., Frank, D., Esper, J., Andreu, L., Bednarz, Z., et al. (2007). Signal strength and climate calibration of a European tree-ring isotope network. *Geophys. Res. Lett.*, 34(24), 2–7. doi:10.1029/2007GL031106

Hees, A. F. M. van (1997). Growth and morphology of pedunculate oak (*Quercus robur* L) and beech (*Fagus sylvatica* L) seedlings in relation to shading and drought. *Annales Sci. Forest.*, 54, 9–18. doi: 10.1051/forest:19970102

Weemstra, M., Eilmann, B., Sass-Klaassen, U.G.W., Sterck, F.J., 2013. Summer droughts limit tree growth across 10 temperate species on a productive forest site. *Forest Ecol. Manag.*, 306, 142-149. doi: 0.1016/j.foreco.2013.06.007

Weitner, A., Dupouey, J. L., Lefèvre, Y., Bréda, N., Badeau, V., et al. (2007). Roles of soil chemistry and water availability in site-related $\delta^{13}\text{C}$ variations in French beech forests. *Tree Physiol.*, 27, 1043–1051. doi: 10.1093/treephys/27.7.1043

Wigley, T. M. L., Briffa, K. R., & Jones, P. D. (1984). On the average value of correlated time series, with applications in dendroclimatology and hydrometeorology. *J. Applied Meteorol. Climatol.*, 23, 201–213. Doi:10.1175/1520-0450(1984)023%3C0201:OTAVOC%3E2.0.CO;2

Young, G. H. F., Mccarroll, D., Loader, N. J., & Kirchhefer, A. J. (2010). A 500-year record of summer near ground solar radiation from tree-ring stable carbon isotopes. *Holocene*. doi:10.1177/0959683609351902.

Young, G.H.F., Bale, R.J., Loader, N., McCarroll, D., Nayling, N., Vousden, N. (2012) Central England temperature since AD 1850: the potential of stable carbon isotope in British oak trees to reconstruct past summer temperatures. *J. Quat. Sci.* 27(6), 606-614. doi: 10.1002/jqs.2554.

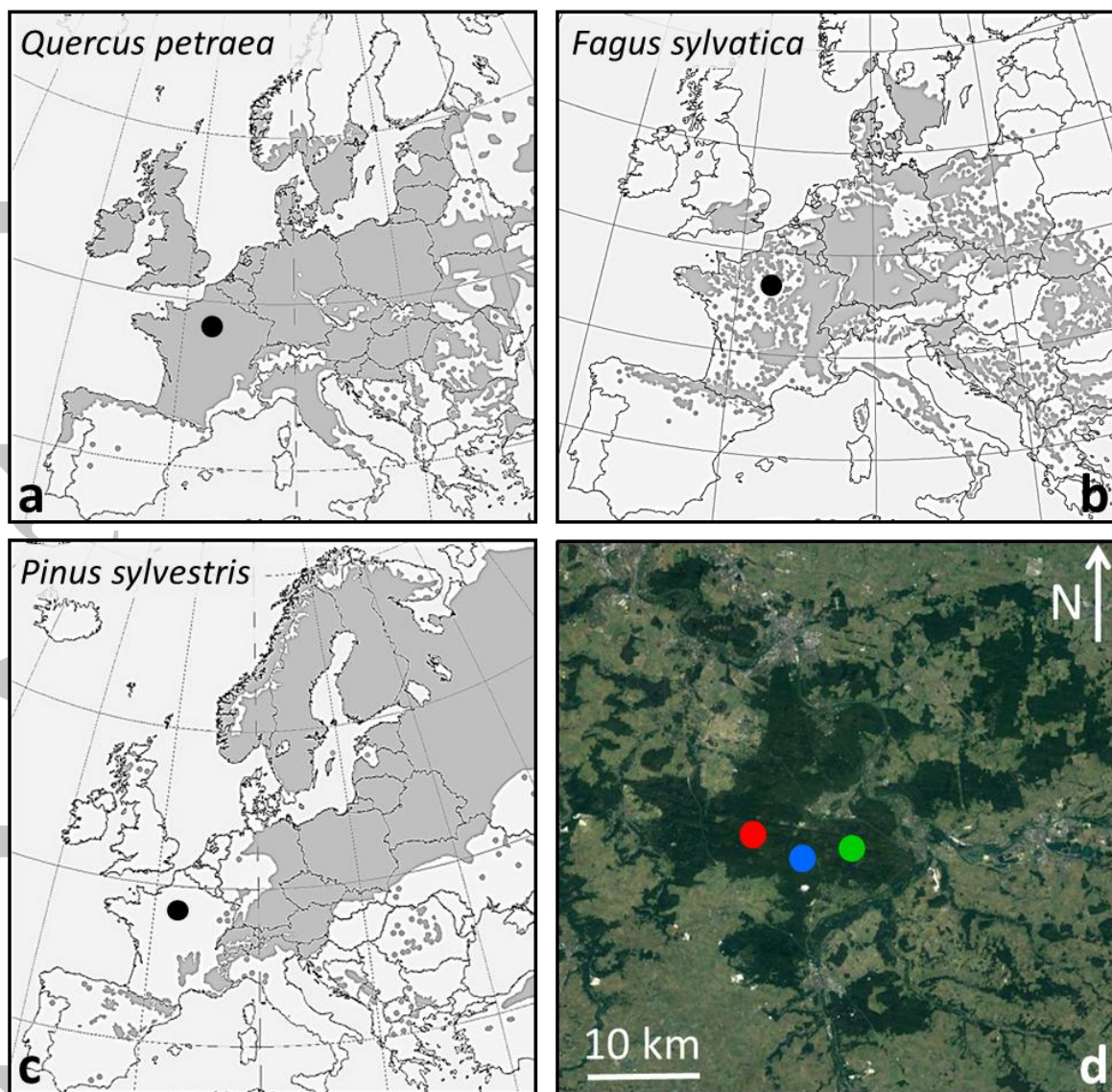
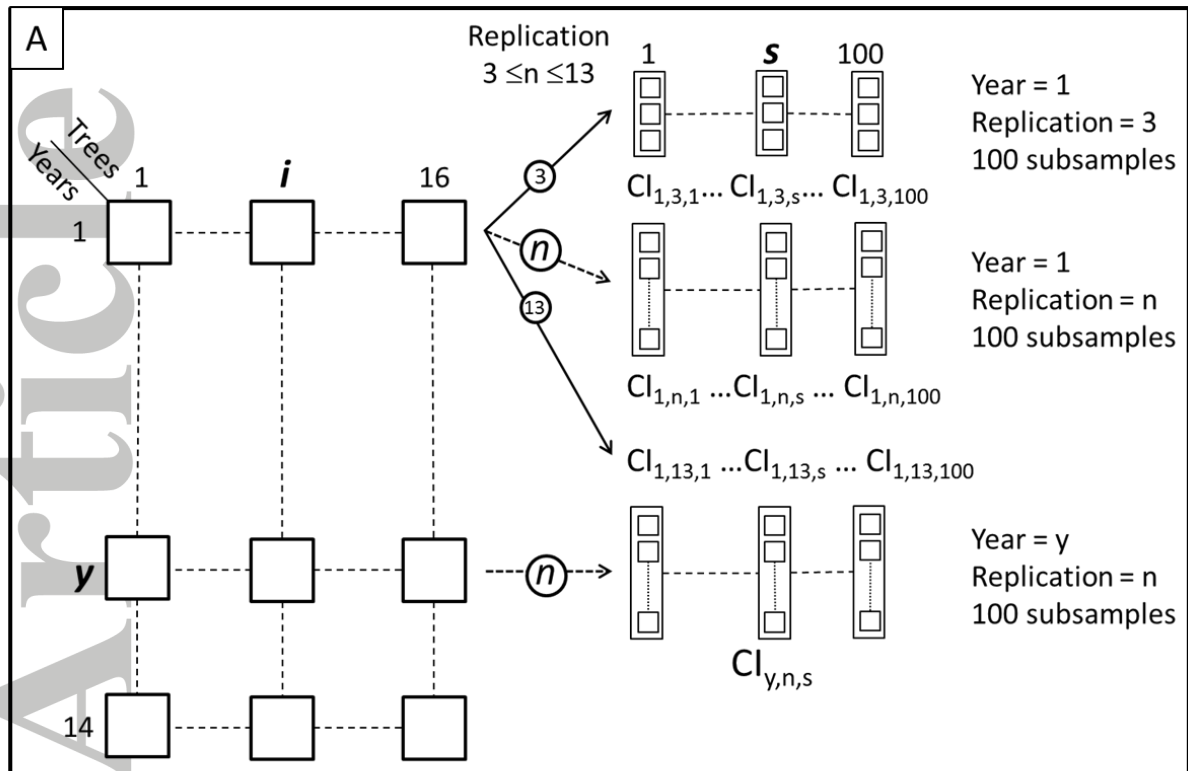

Figure 1: Natural distribution of a) *Quercus petraea*, b) *Fagus sylvatica* and c) *Pinus sylvestris* in Europe (from <http://www.euforgen.org/distribution-maps/>) and location of the study site (black point); d) Sampling sites in Fontainebleau forest (Red: *Quercus petraea*, blue: *Fagus sylvatica* and green: *Pinus sylvestris*).



B

$$\overline{CI}_n = \left[\sum_{y=1}^{14} \sum_{s=1}^{100} CI_{y,n,s} \right] / 1400$$

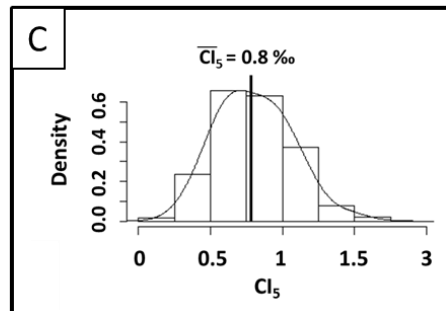

Figure 2: A) Schematic representation of the algorithm for the calculation of the average confidence intervals (\overline{CI}). B) Equation of \overline{CI} for a level of replication n . C) Example of the distribution of the 1400 CI generated from $\delta^{13}C$ in *Q. petraea* for a level of replication $n=5$. The average value is: $\overline{CI} = 0.8\%$. The calculations were conducted over the period 1994-2007.

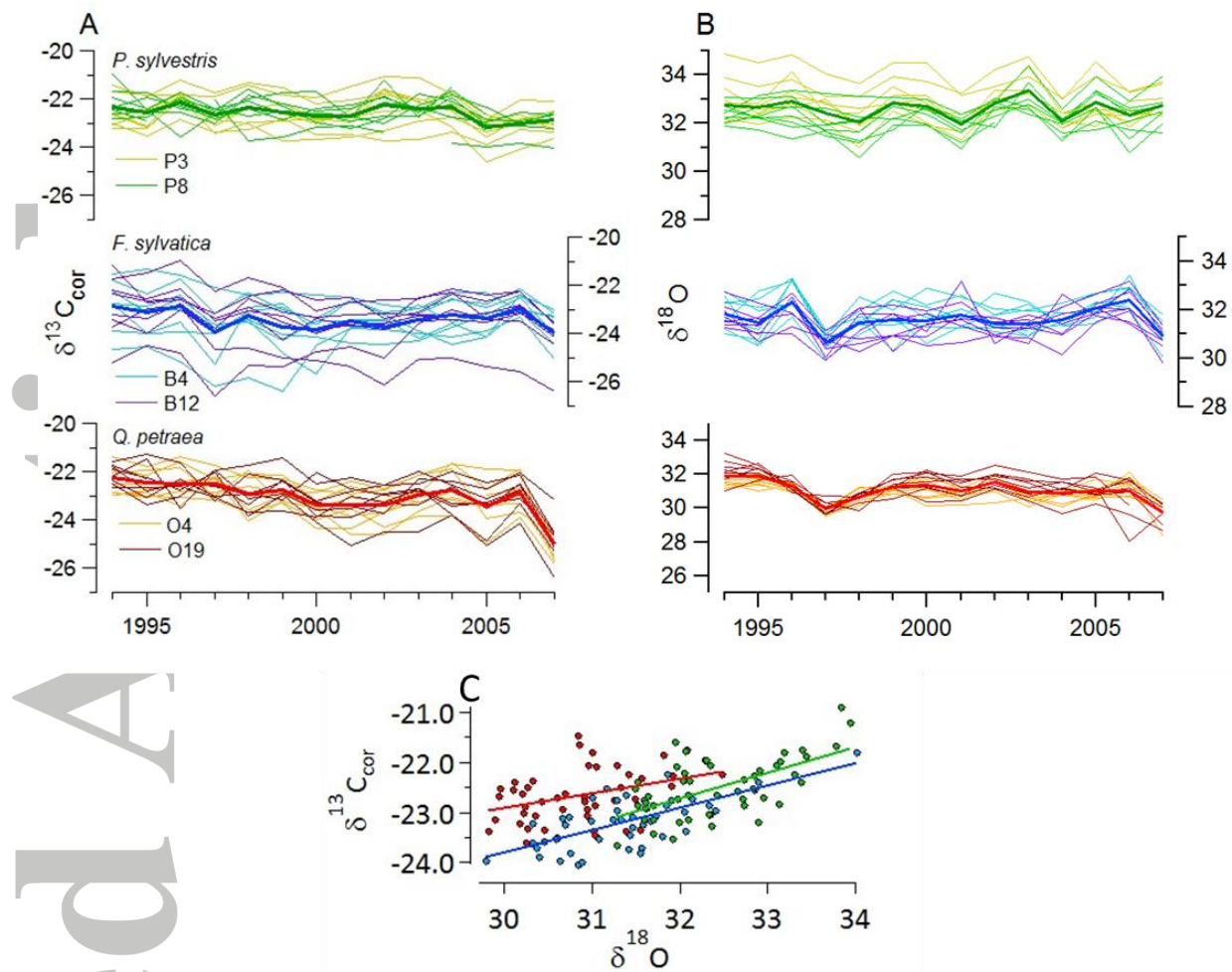

Figure 3: (A) and (B): $\delta^{13}C_{cor}$ and $\delta^{18}O$ chronologies of *Q. petraea* (cellulose of latewood), *F. sylvatica* and *P. sylvestris* (cellulose of total wood) over 1994-2007. Fine lines: individual chronologies (16 trees/species from 2 stands; 1 colour per stand); bold lines: mean chronologies for each species. C: Correlation diagrams of the carbon and oxygen mean isotopic chronologies of *Q. petraea* (red), *F. sylvatica* (blue) and *P. sylvestris* (green). The respective correlation coefficients are $R = 0.43, 0.70$ and $0.60, p < 0.05$.

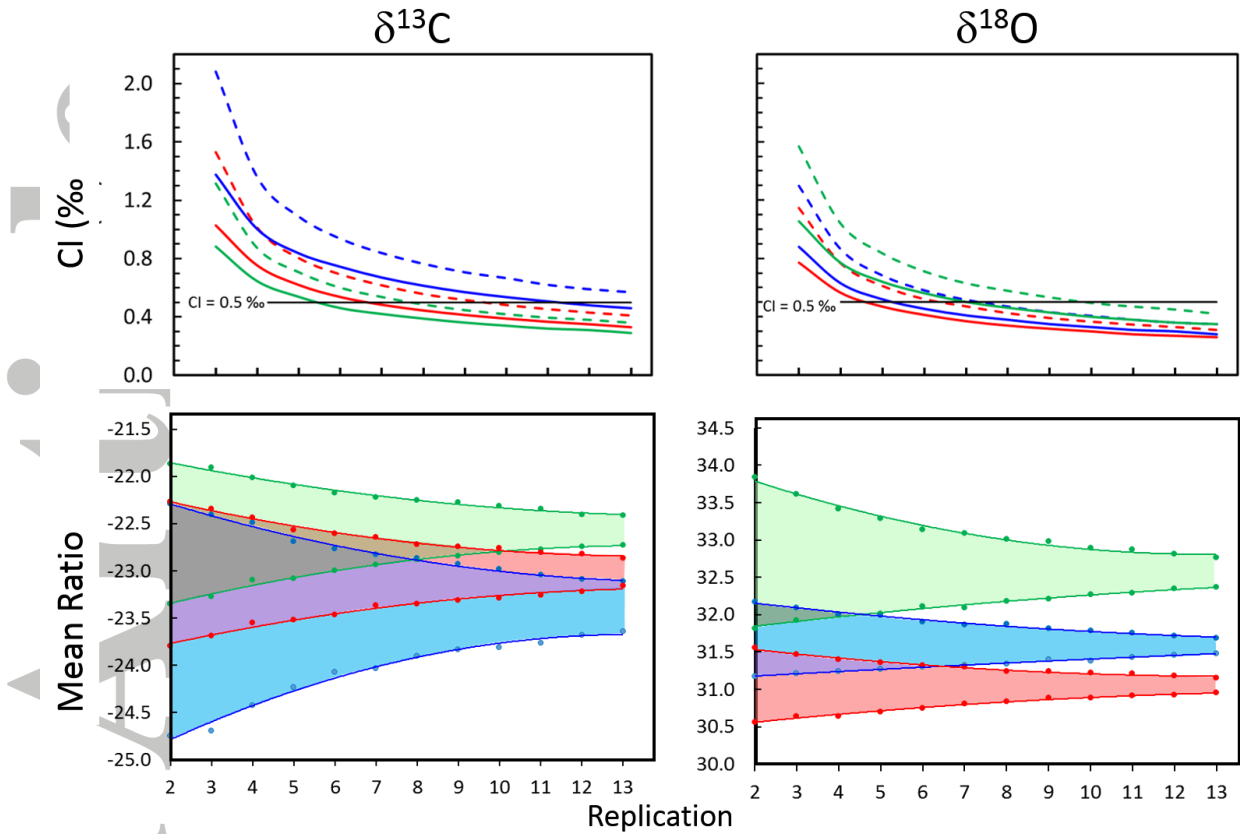

Figure 4: Estimates of the mean values of the CI at confidence levels of 90% and 95% (solid and dotted lines resp., top panel) and ranges of possible mean ratios (bottom panel) for $\delta^{13}\text{C}_{\text{cor}}$ (left column) and $\delta^{18}\text{O}$ (right column) of *Q. petraea* (red), *F. sylvatica* (blue) and *P. sylvestris* (green). The black horizontal lines in the top panels correspond to CI = 0.5‰. The individual chronologies spanning 1994-2007 were used for the calculations.

Accepted

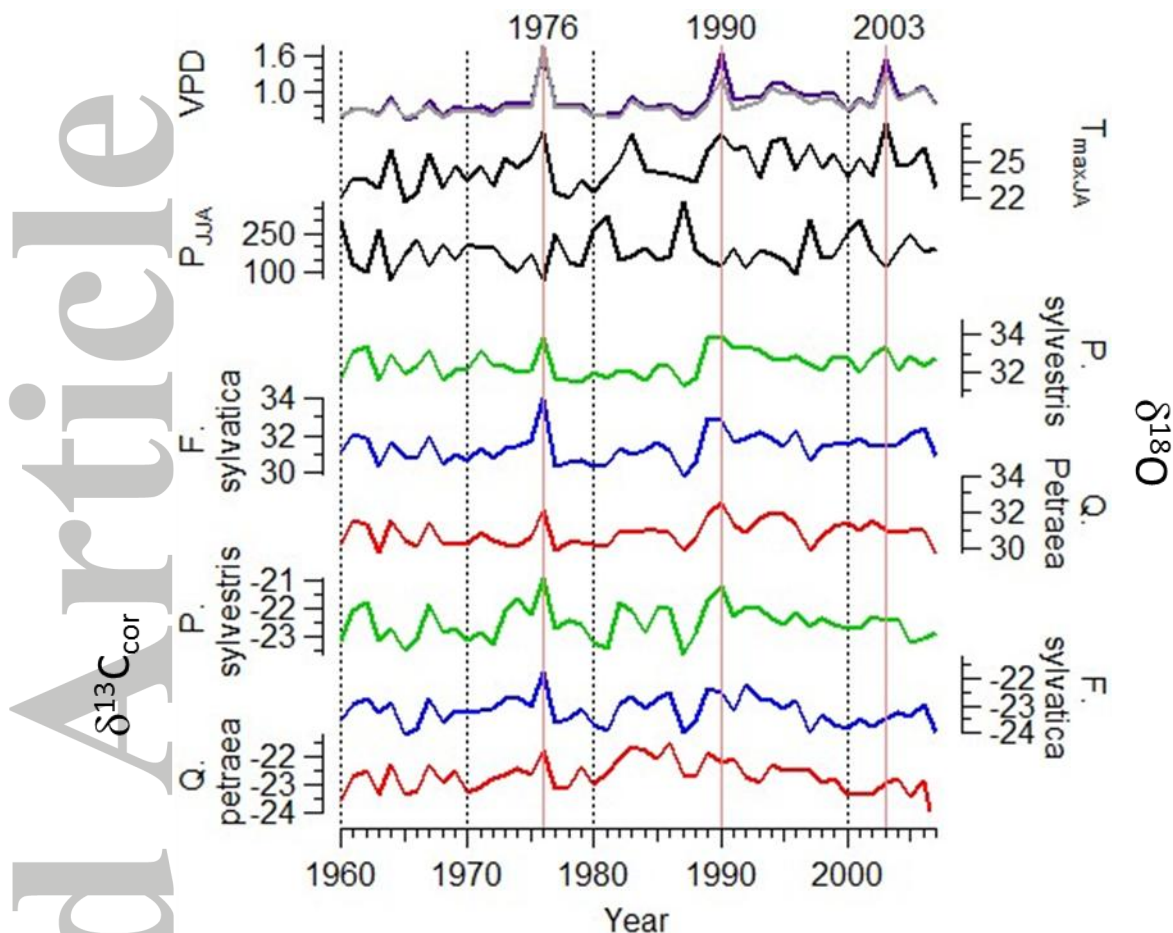

Figure 5: Mean $\delta^{13}\text{C}_{\text{cor}}$ and $\delta^{18}\text{O}$ chronologies of *Q. petraea* (red), *F. sylvatica* (blue) and *P. sylvestris* (green) from Fontainebleau forest, precipitation over June-August (in mm), maximum temperature averaged over July-August (T_{maxJA} in $^{\circ}\text{C}$), vapour pressure deficit (VPD in kPa) averaged over July-August (purple) or June-August (grey) over the years 1960 to 2007. Years 1976, 1990 and 2003, which have experienced extremely high summer temperature and VPD are shown by vertical red lines. Extremely low precipitation was also registered in 1976 and 1990.

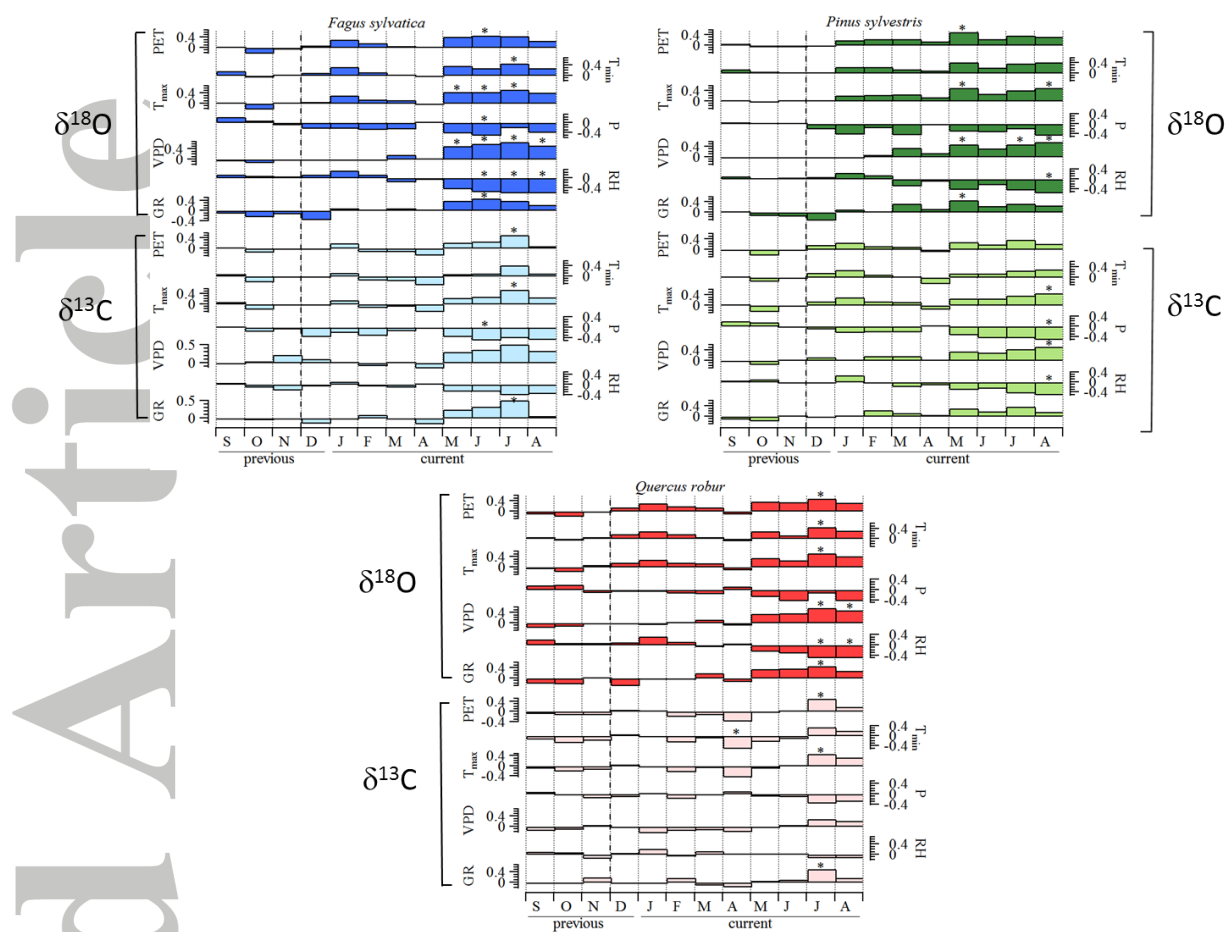

Figure 6: Correlations between species $\delta^{18}\text{O}$ (in ‰; bright colours) and $\delta^{13}\text{C}$ (in ‰; pale colours) chronologies and monthly local climate variables for the 1960-2007 period. Correlations correspond to a 12 months window from September of the previous year to August of the current year. Stars denote correlations significant at 99% confidence interval. GR: Global radiation (in $\text{MJ}\cdot\text{m}^{-2}\cdot\text{day}^{-1}$); RH: relative humidity (in %); VPD: vapour pressure deficit (in kPa); P: precipitation (in mm); T_{\max} , T_{\min} : maximum and minimum temperature (in $^{\circ}\text{C}$).

Table 1: Stand characteristics

Stand	Species	AWC ^a (mm)	Rooting depth (cm)	LAI ^b	Soil type	Age ^c (Years)
O4	<i>Q. petraea</i>	115	120	6.5	Haplic Albeluvisol	151
O19	<i>Q. petraea</i>	180	180	5.5	Endostagnic Luvisol	199
B4	<i>F. sylvatica</i>	141	165	5.6	Entic Podzol to Ludisol	114
B12	<i>F. sylvatica</i>	101	107	5.5	Haplic Albeluvisol	92
P3	<i>P. sylvestris</i>	118	160	3.7	Albic Podzol	68
P8	<i>P. sylvestris</i>	100	140	3.8	Ortsteinic Albic Podzol	84

^aAWC: soil available water capacity. ^bLAI: Leaf area index during 1994-2000. ^cMean age of the dominant trees in 2008 (measured at breast height); from Barbaroux (2002) and Michelot et al. (2012a).

Table 2: Coherence of the individual $\delta^{13}\text{C}_{\text{cor}}$ and $\delta^{18}\text{O}$ isotopic series over 1994-2007.

Species	$\delta^{13}\text{C}_{\text{cor}}$					$\delta^{18}\text{O}$				
	\bar{M}^a	\overline{SD}^b	\bar{R}^c	N _{EPS>0.85^d}	N _{95CI<0.5^e}	\bar{M}^a	\overline{SD}^b	\bar{R}^c	N _{EPS>0.85^d}	N _{95CI<0.5^e}
<i>Q. petraea</i>	-23.04	0.67	0.56	5	10	31.04	0.52	0.67	3	7
<i>F. Sylvatica</i>	-23.41	0.94	0.31	13	>13	31.60	0.57	0.49	6	8
<i>P. sylvestris</i>	-22.58	0.59	0.28	14	8	32.61	0.71	0.48	6	10

^aMean value of the individual series (16 trees/species). ^bMean value of the yearly standard deviations of the series. ^cMean value of the Pearson coefficients of the inter-individual correlations. ^dLevel of replication for EPS \geq 0.85. ^eLevel of replication for 95% CI < 0.5%.

Table 3: Pairwise comparisons of the mean levels and variability of $\delta^{13}\text{C}_{\text{cor}}$ and $\delta^{18}\text{O}$ over the whole period (1960-2007).

		<i>Q. petraea</i> <i>/F. sylvatica</i>	<i>F. sylvatica</i> <i>/P. sylvestris</i>	<i>Q. petraea</i> <i>/P. sylvestris</i>
$\delta^{13}\text{C}_{\text{cor}}$	F-test ^a	0.157	0.215	0.859
	t-test ^b	< 0.001	< 0.001	0.068
	R _{species} ^c	0.65	0.78	0.54
$\delta^{18}\text{O}$	F-test ^a	0.26	0.41	< 0.001
	t-test ^b	< 0.001	0.001	< 0.001
	R _{species} ^c	0.82	0.79	0.74

^ap-value of Fisher's F-test. ^bp-value of Student's t-test. ^cInter-species Pearson correlation coefficient (p-value < 0.001).

Accepted Article

Version postprint