

Diffraction Removal in an Image-based BRDF Measurement Setup

Antoine LUCAT, Ramon HEGEDUS and Romain PACANOWSKI

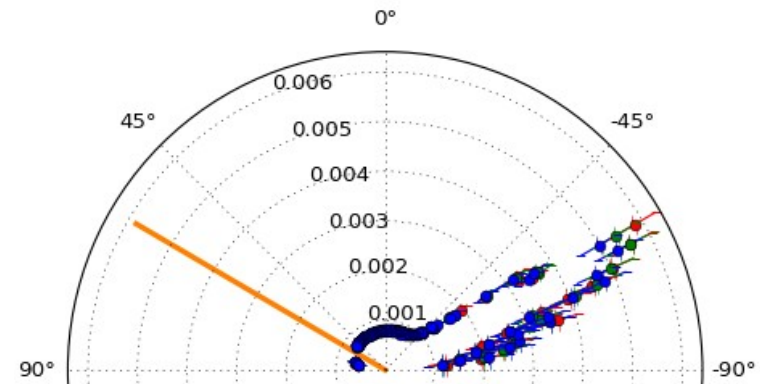

Measuring the Appearance of Materials

Understanding & Predicting **light interaction** on surfaces

- Study of Matter-Light interaction
- Realistic rendering
- Material design

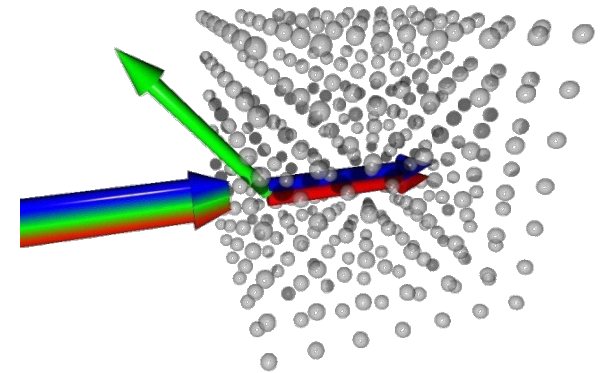

Measuring the Appearance of Materials

Understanding & Predicting **light interaction** on surfaces

- Study of Matter-Light interaction
- Realistic rendering
- Material design

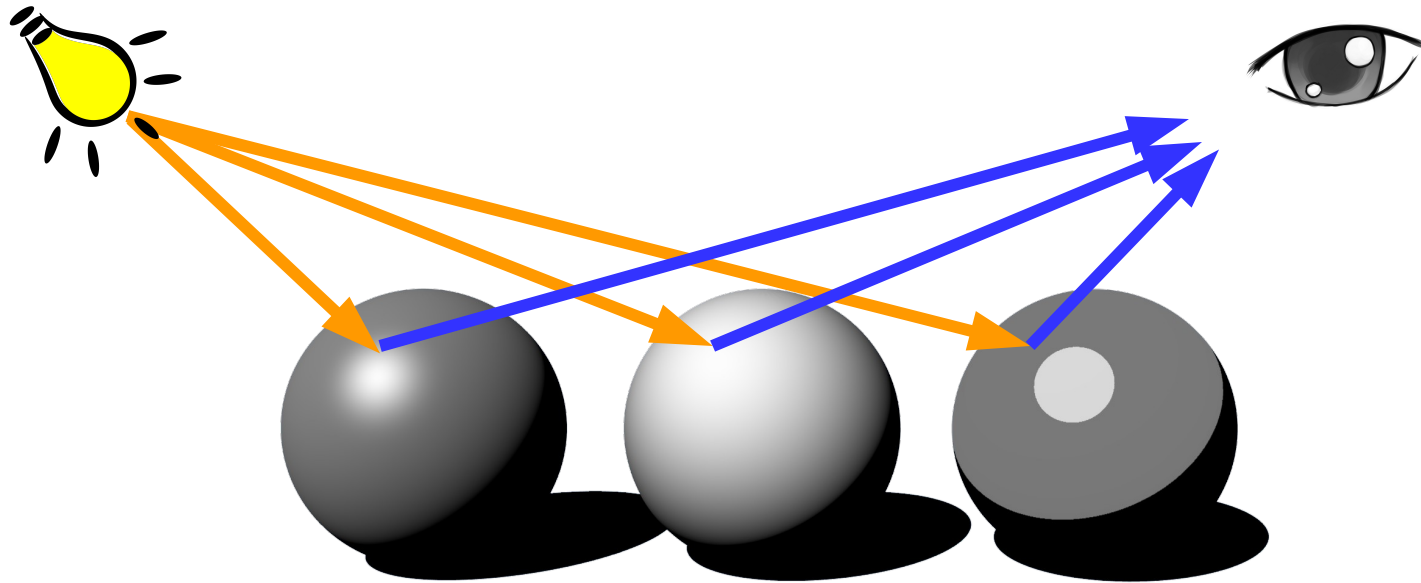

How materials **scatter light** ?

Fundamental Radiometric Quantity

The Bidirectional Reflectance Distribution Function (BRDF) :

$$BRDF(\omega_i, \omega_o) \propto \frac{\Phi_{\omega_o}}{(\pi \cdot \omega_i) \Phi_{\omega_i}}$$

A Quantitative Qualification

Computer Graphics



Photograph



CG image

Image-space comparison

Optics & Metrology

Used for light transport simulations

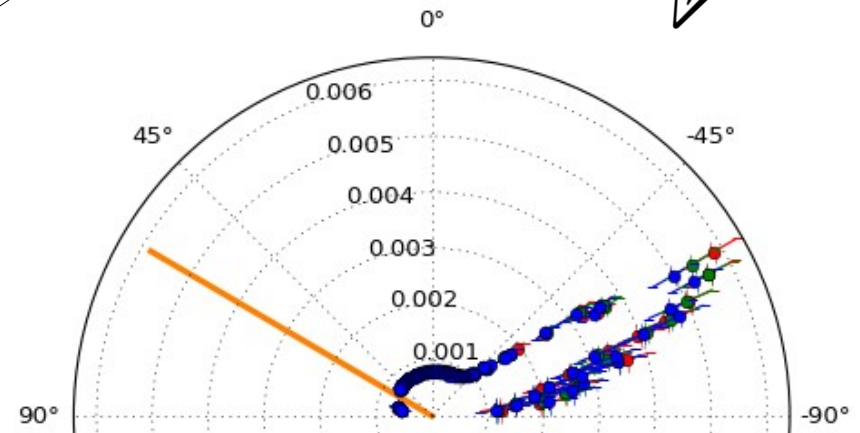

Measurement Uncertainties

Image-based Measurement Setup

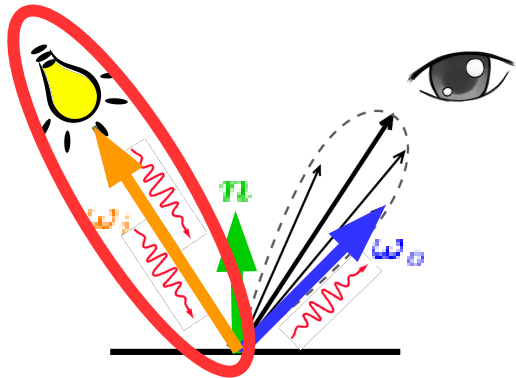
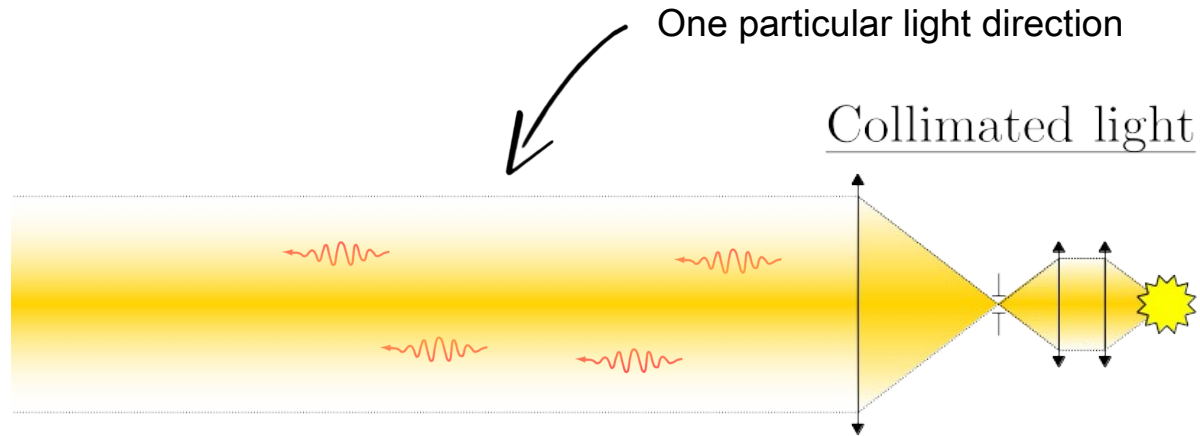

Inspired by
[Matusik03]
[Marchner98]

Image-based Measurement Setup

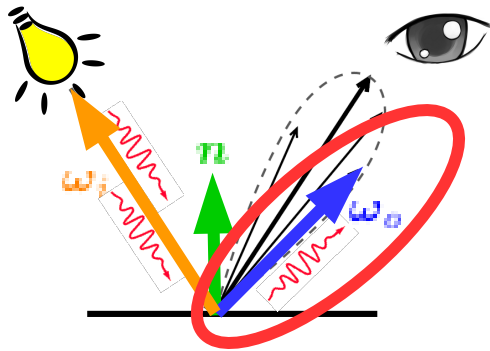
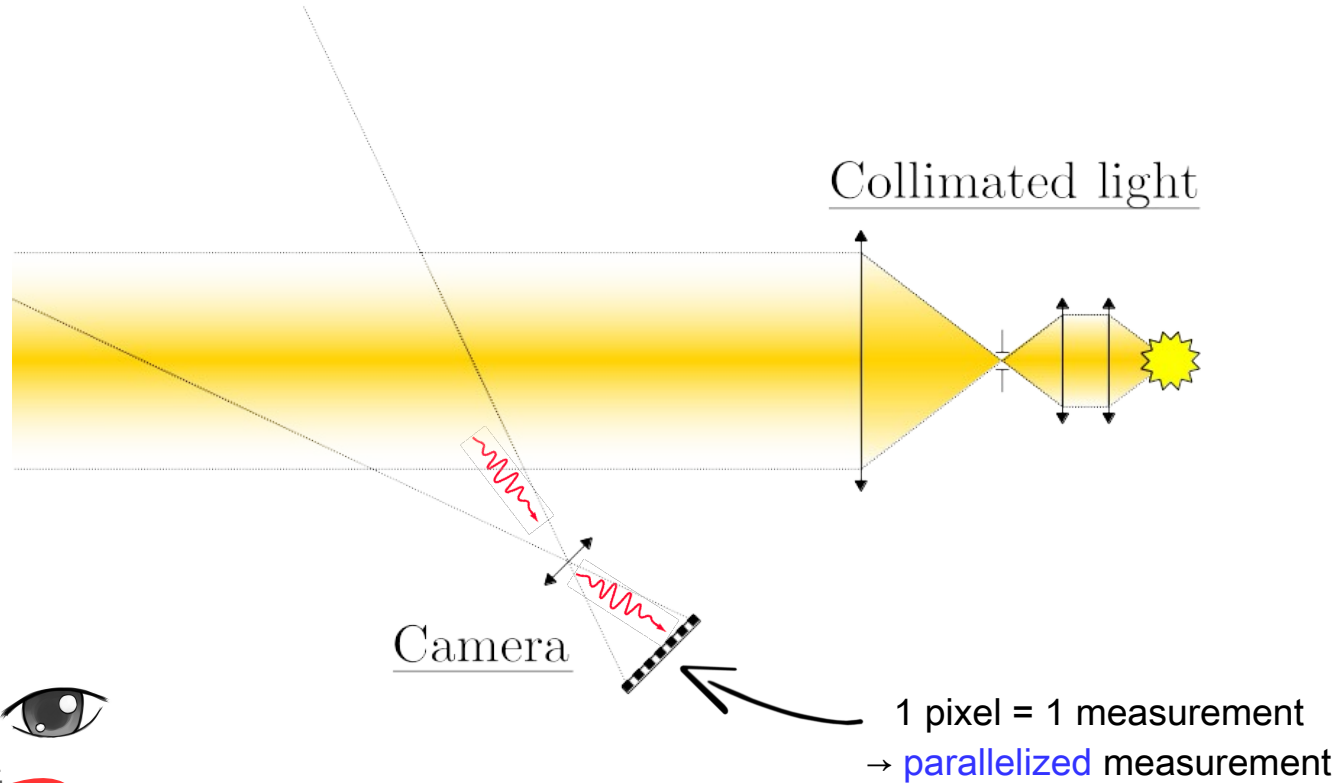

Inspired by
[Matusik03]
[Marchner98]

Image-based Measurement Setup

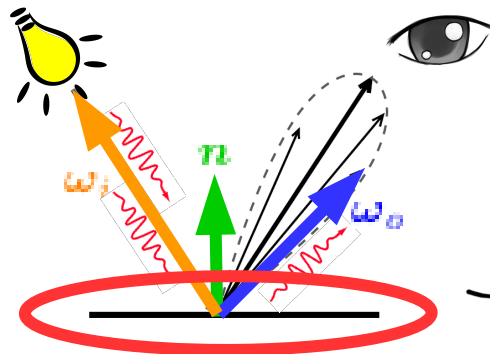
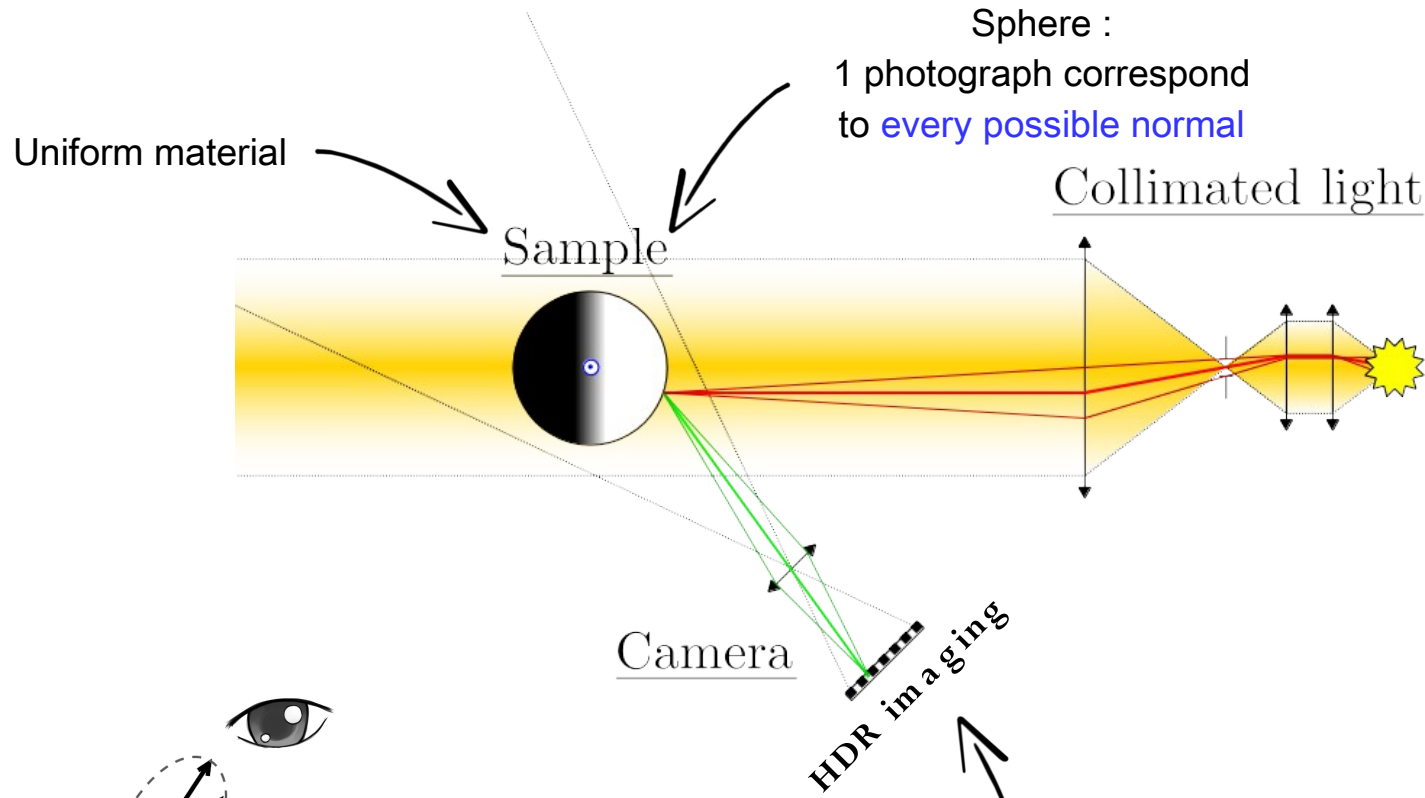

Inspired by
[Matusik03]
[Marchner98]

Image-based Measurement Setup

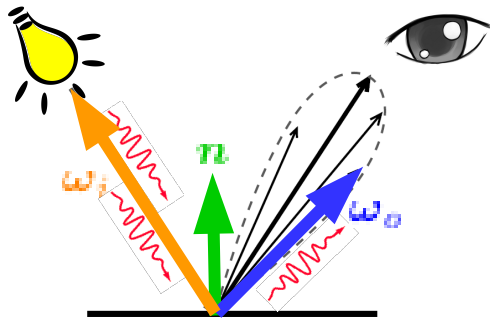
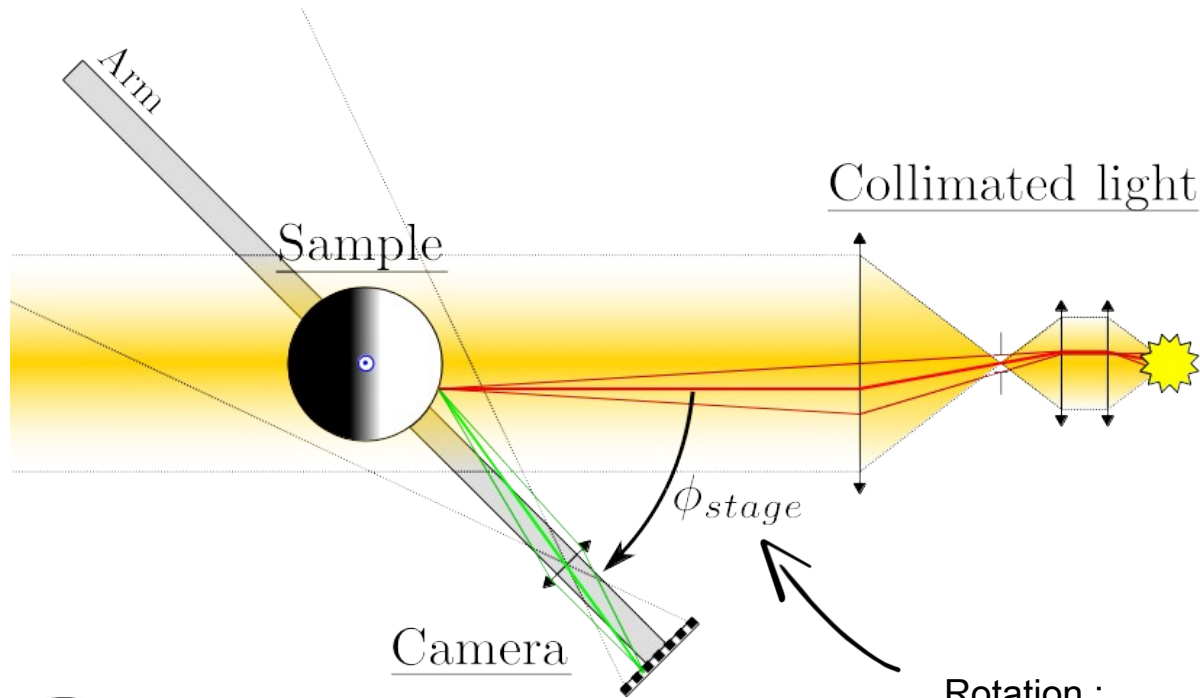

Rotation :
Covers every light-view configurations

Inspired by
[Matusik03]
[Marchner98]

Image-based Measurement Setup

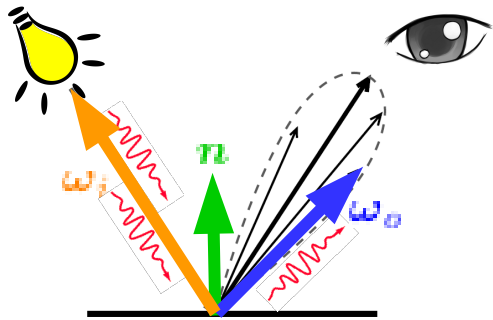
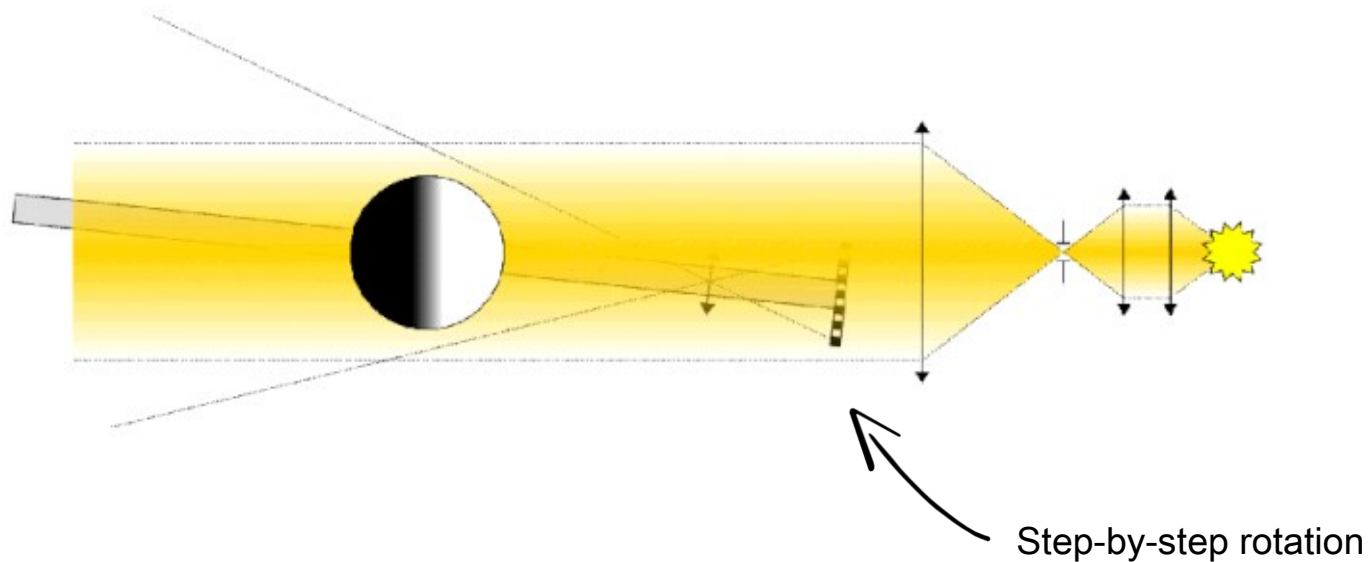

→ 3 degrees of freedom ←
Isotropic BRDF measurement

Inspired by
[Matusik03]
[Marchner98]

Measurement Process

1 - Calibration

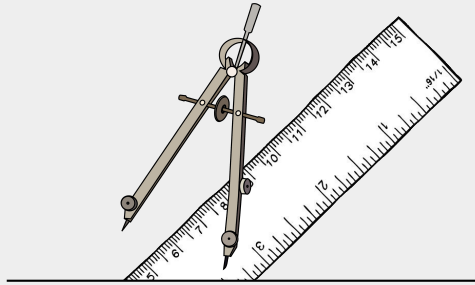

Camera

Measurement Process

1 - Calibration

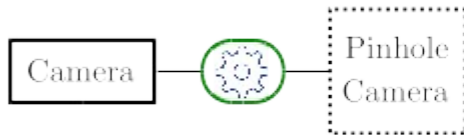
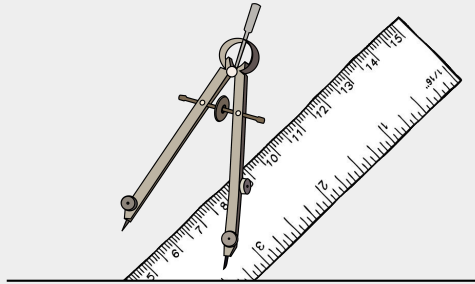

Measurement Process

1 - Calibration

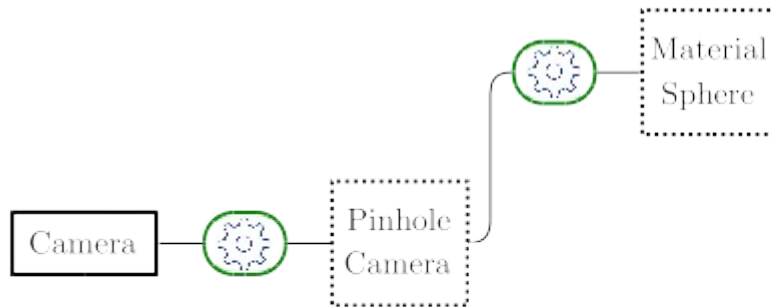
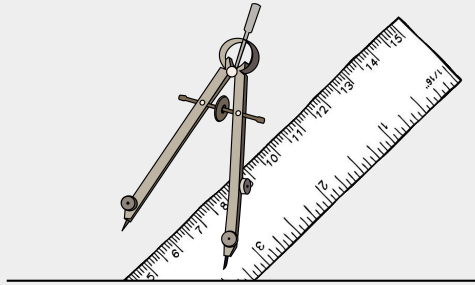

Measurement Process

1 - Calibration

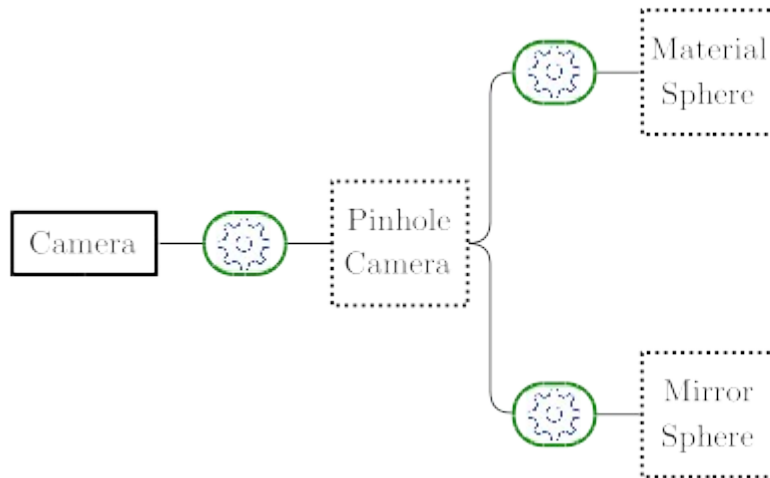
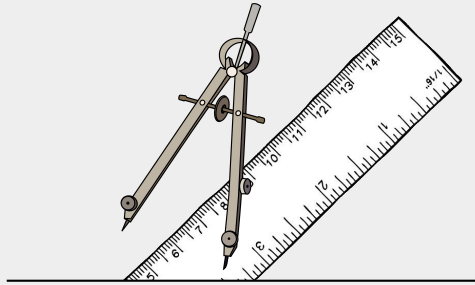

Measurement Process

1 - Calibration

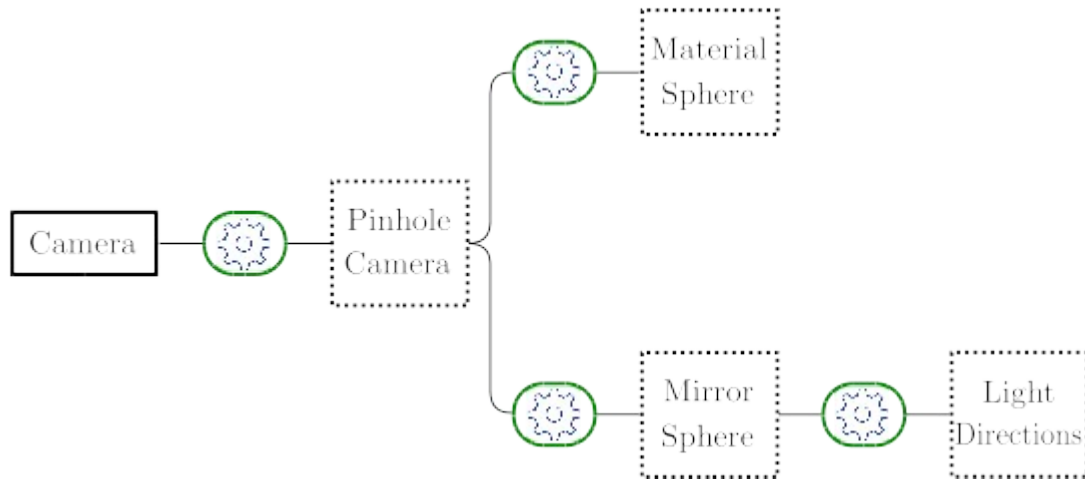
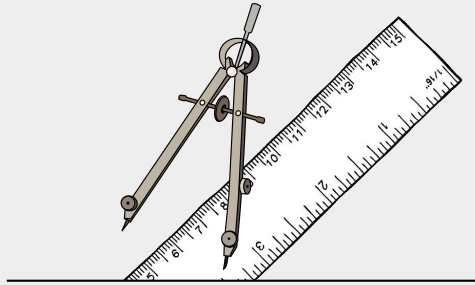

Measurement Process

1 - Calibration

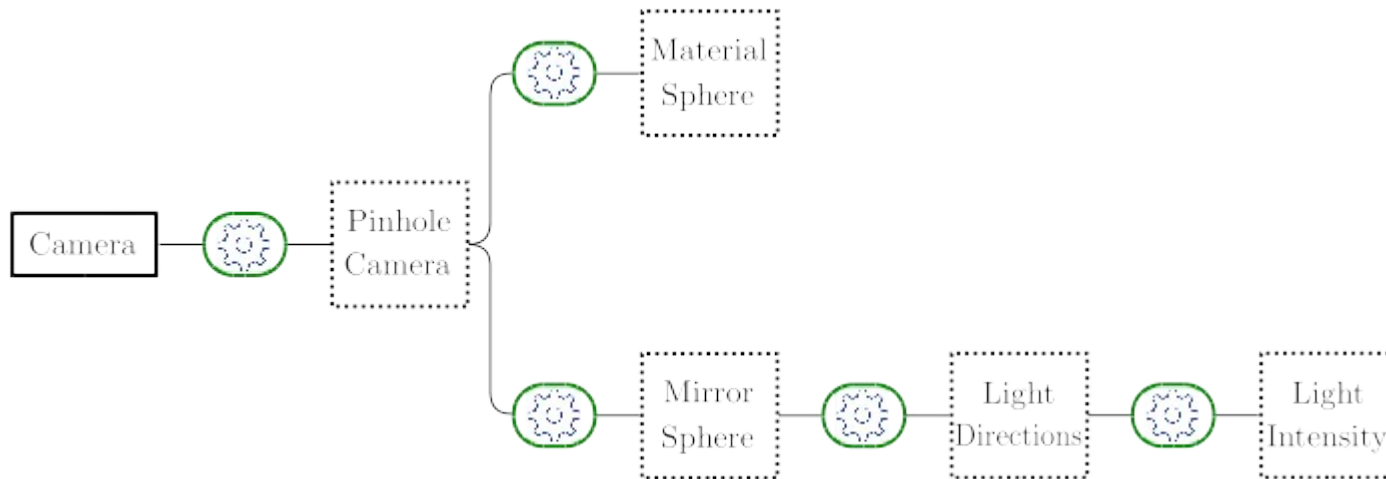
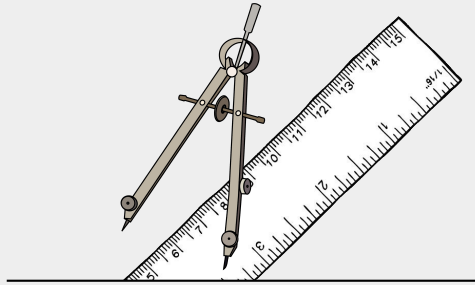

Measurement Process

1 - Calibration

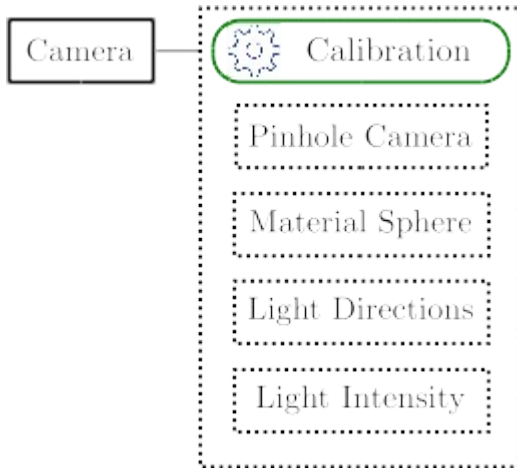
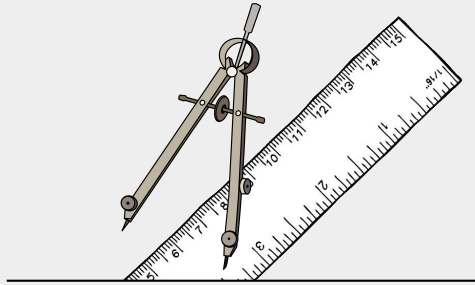

Measurement Process

1 - Calibration

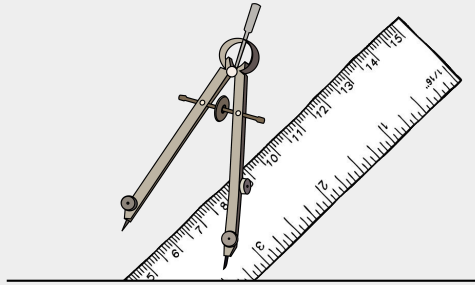

2 - Raytracing

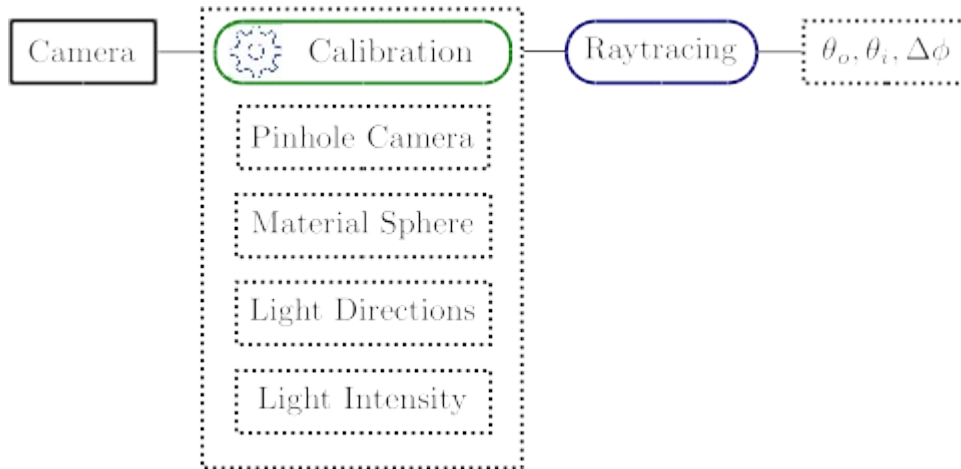
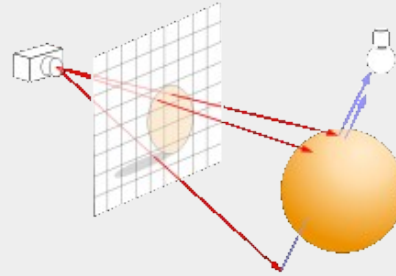

BRDF configuration
for each pixel

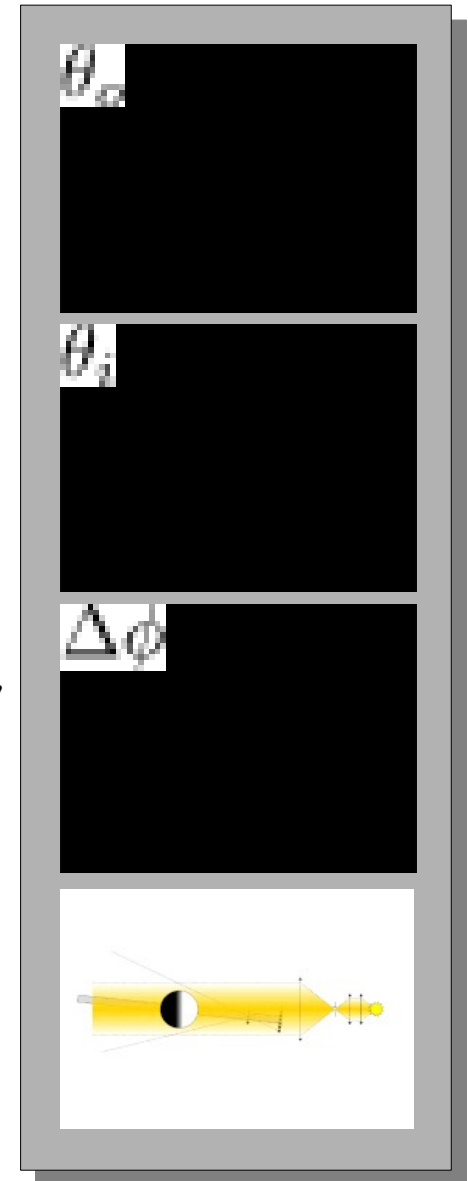

Measurement Process

1 - Calibration

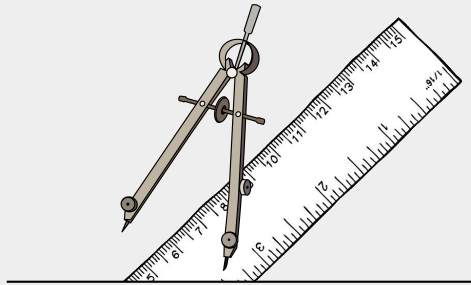

2 - Raytracing

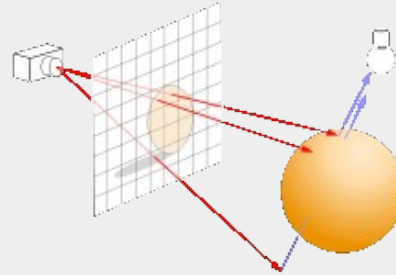

3 - Capture

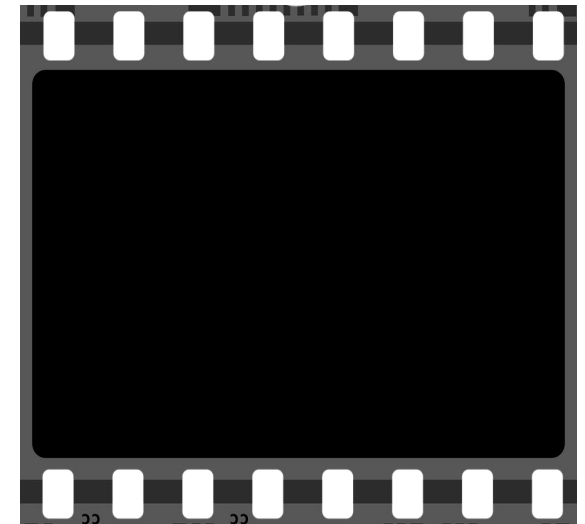
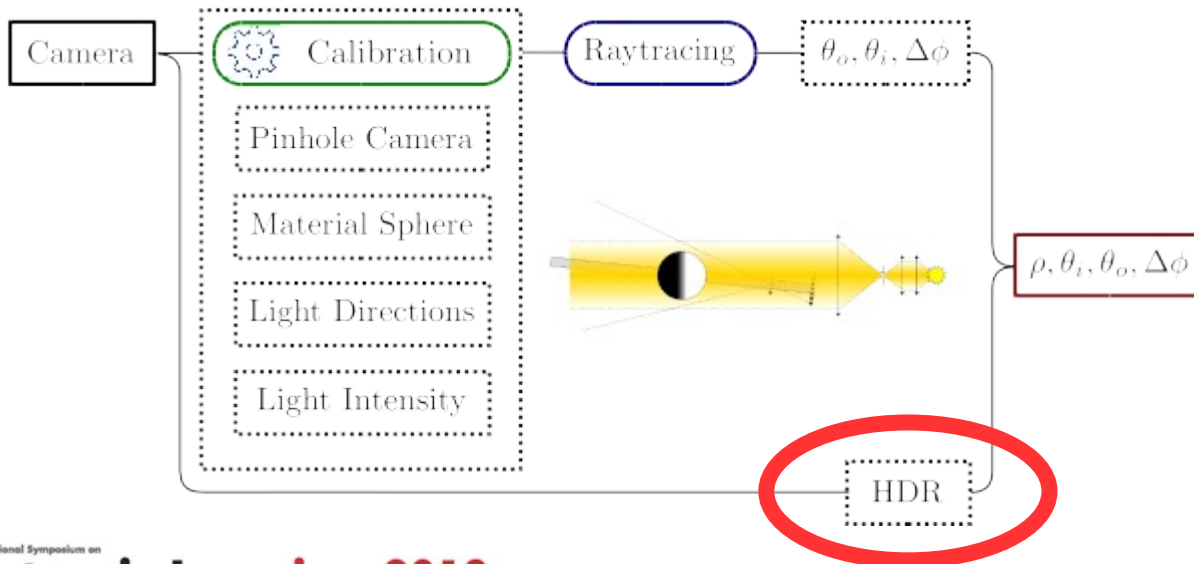
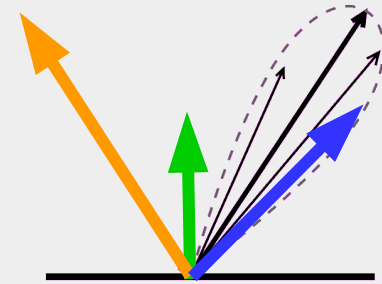

Practical Issues

- Material **uniformity** ✘

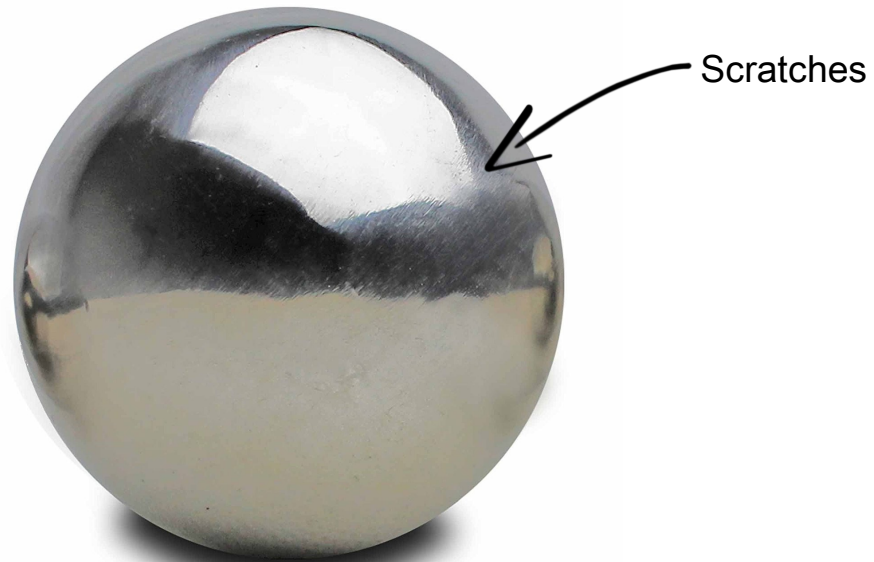

Practical Issues

- Material **uniformity** ✘
- **Incoherent** light ✔

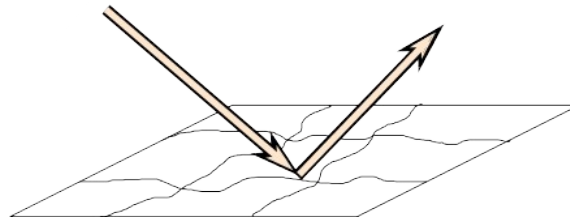
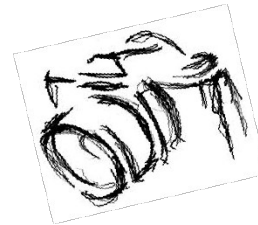
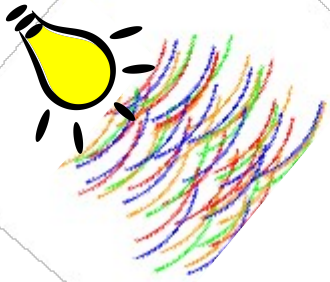

Practical Issues

- Material **uniformity** ✘
- **Incoherent** light ✘

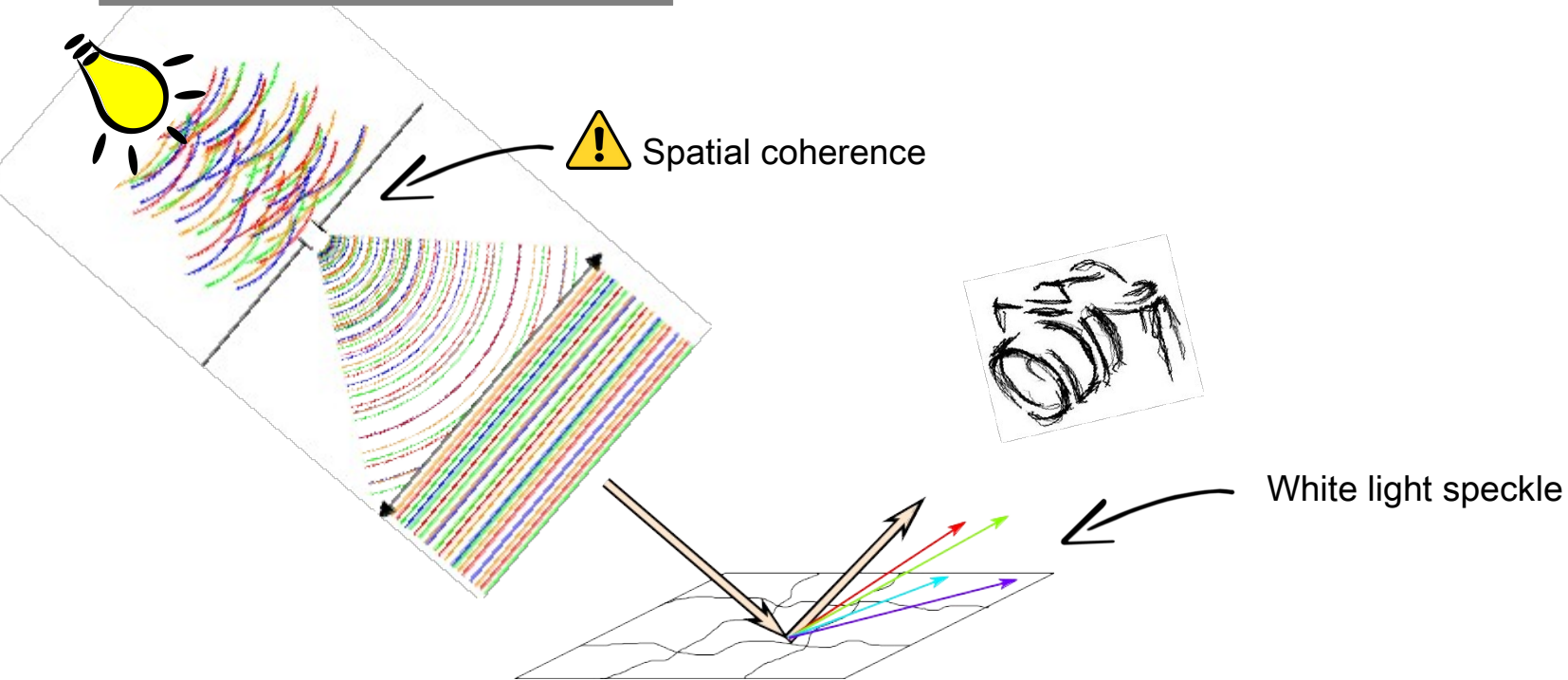

Practical Issues

- Material **uniformity** ✘
- **Incoherent** light ✘

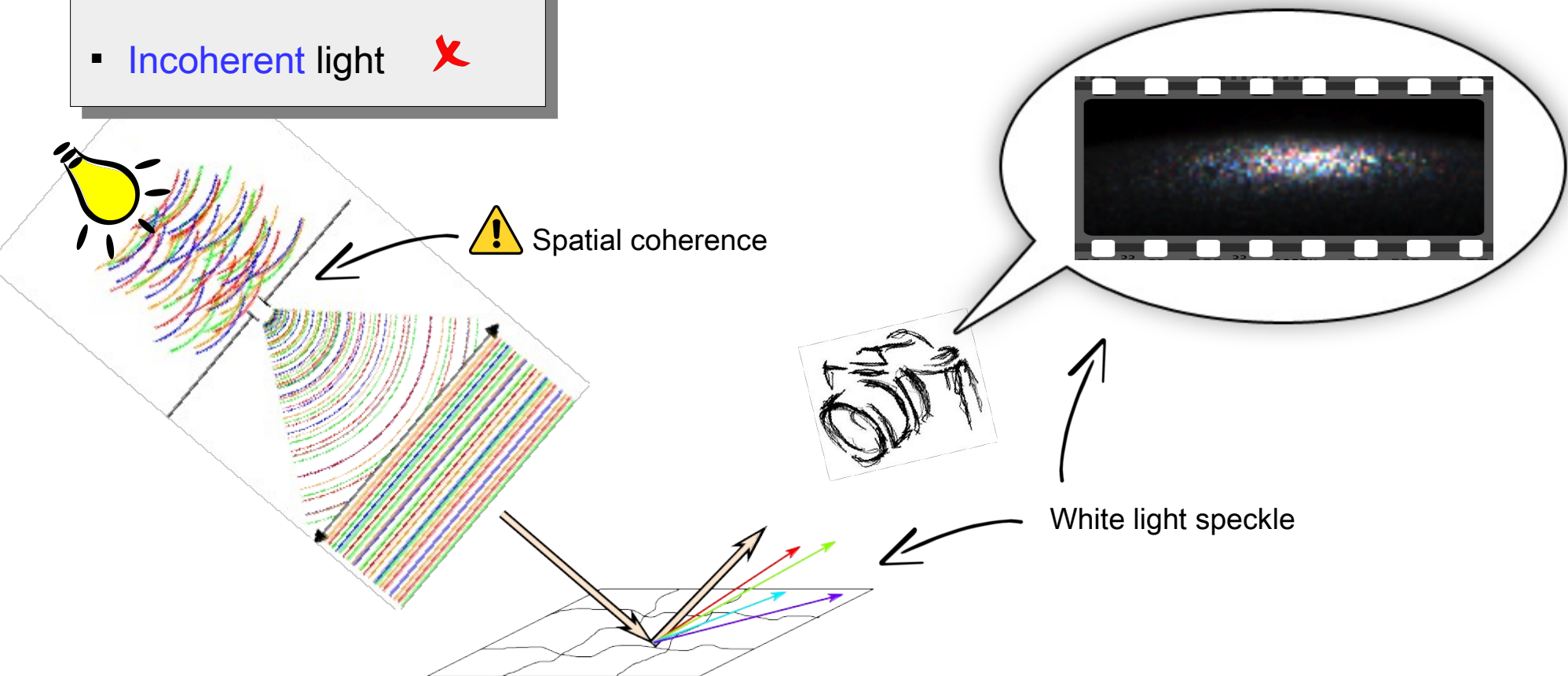

Practical Issues : our Solution

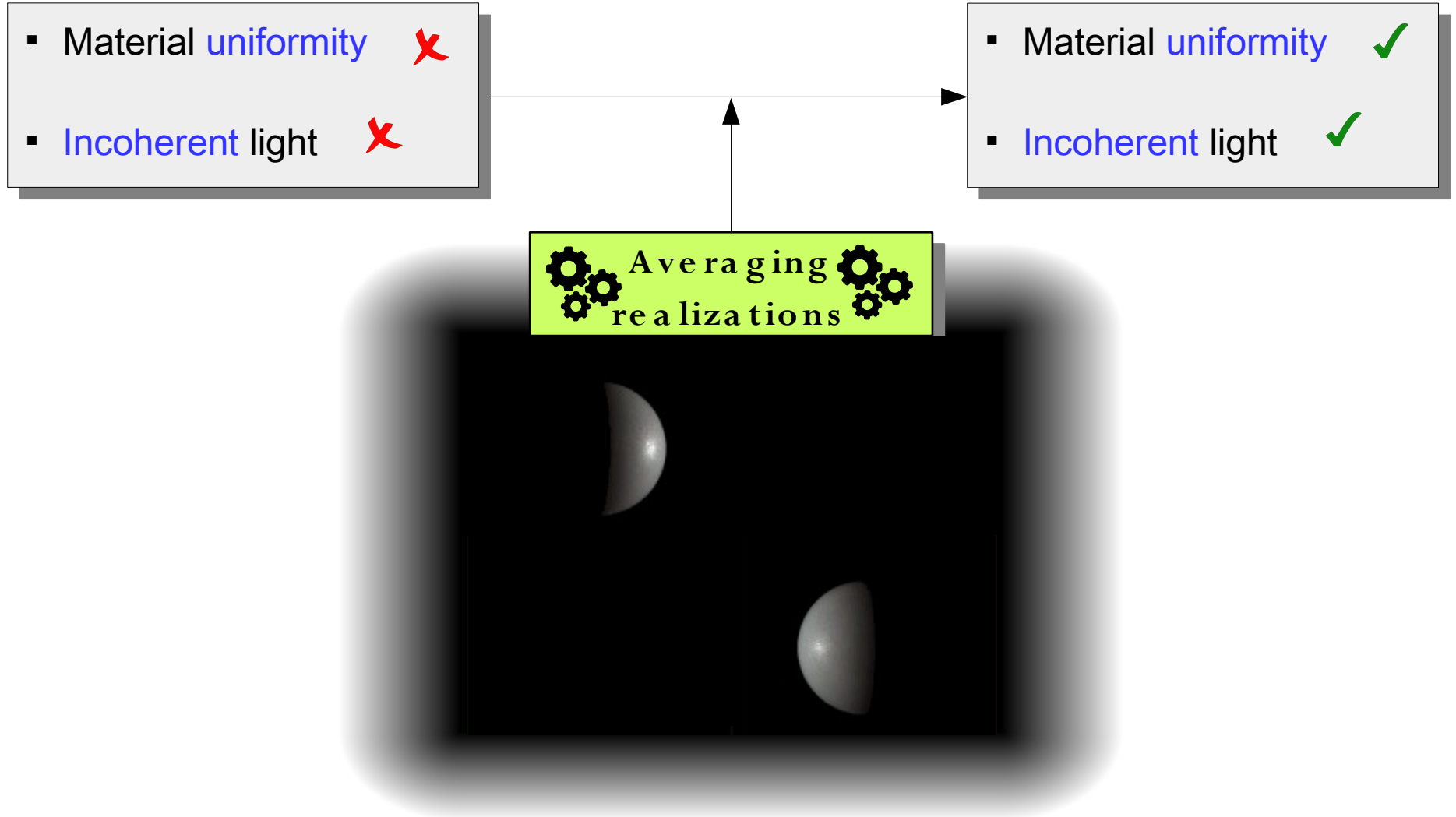

Error Propagation

+ = Uncertainty source

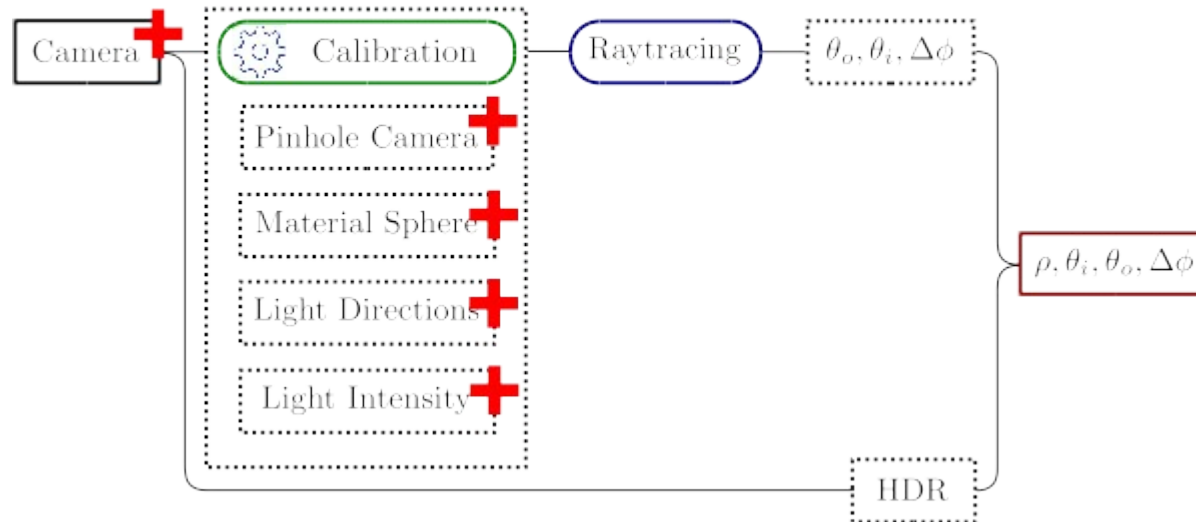

Error Propagation

+ = Uncertainty source **→** = Uncertainty propagation

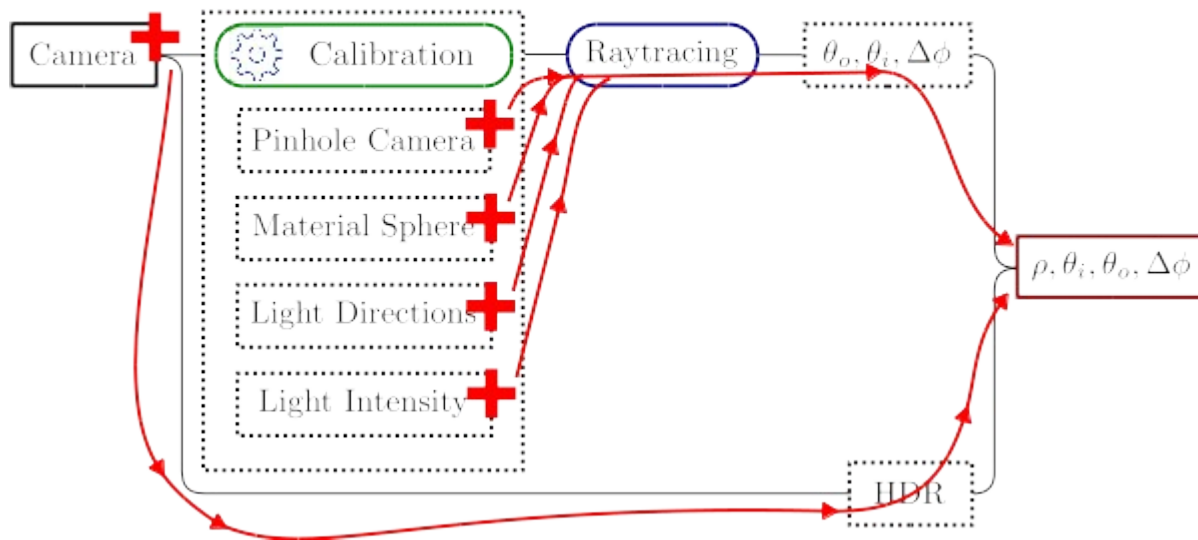

Propagation

$$\text{Error} = \sqrt{\sum_i \left(\frac{\partial f}{\partial x_i}\right)^2 \text{Error}_{x_i}^2}$$

Multiple uncorrelated noise
→ No correlations
[Farrance 12]

Diffraction : an Image Space Bias

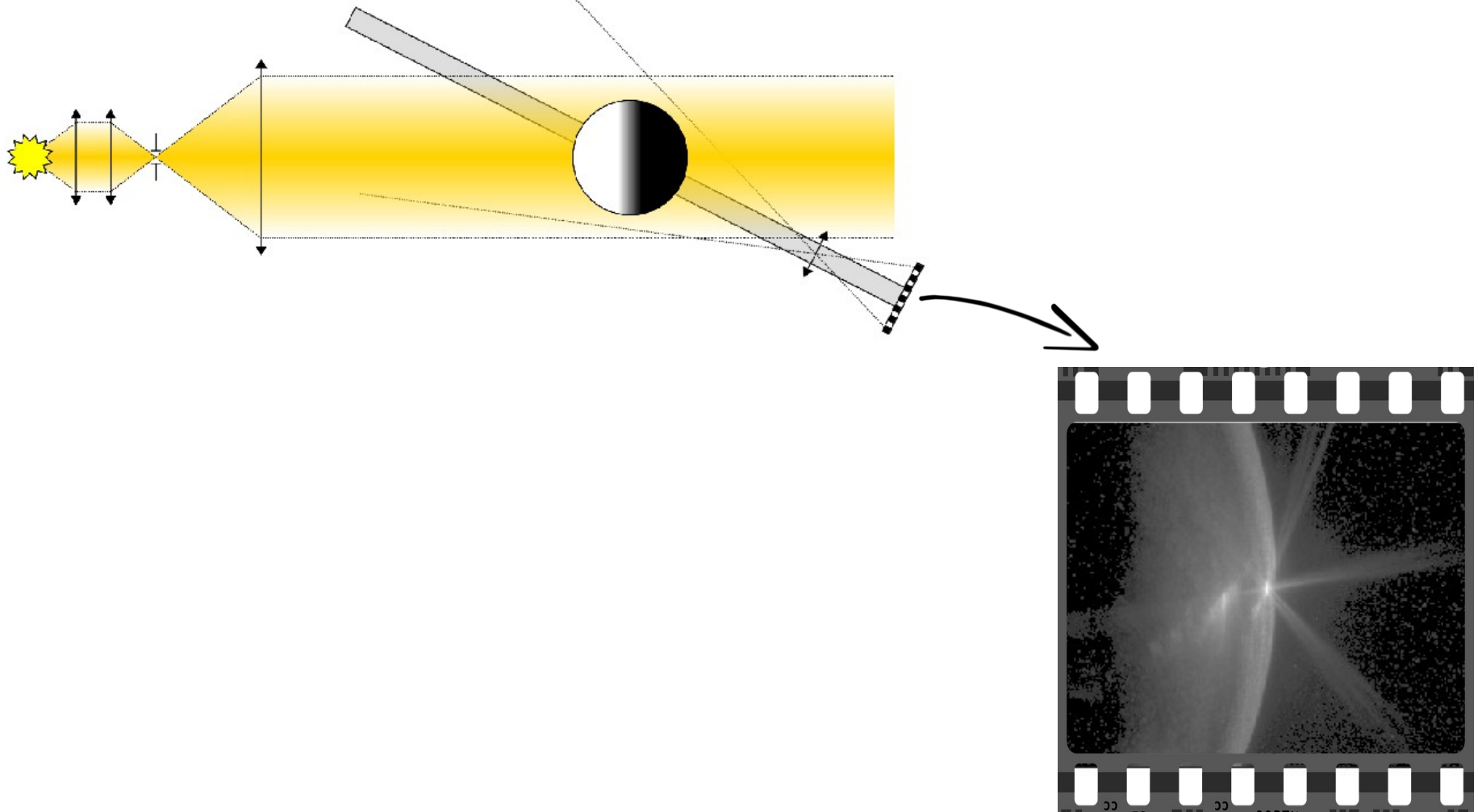

Photograph

Diffraction : an Image Space Bias

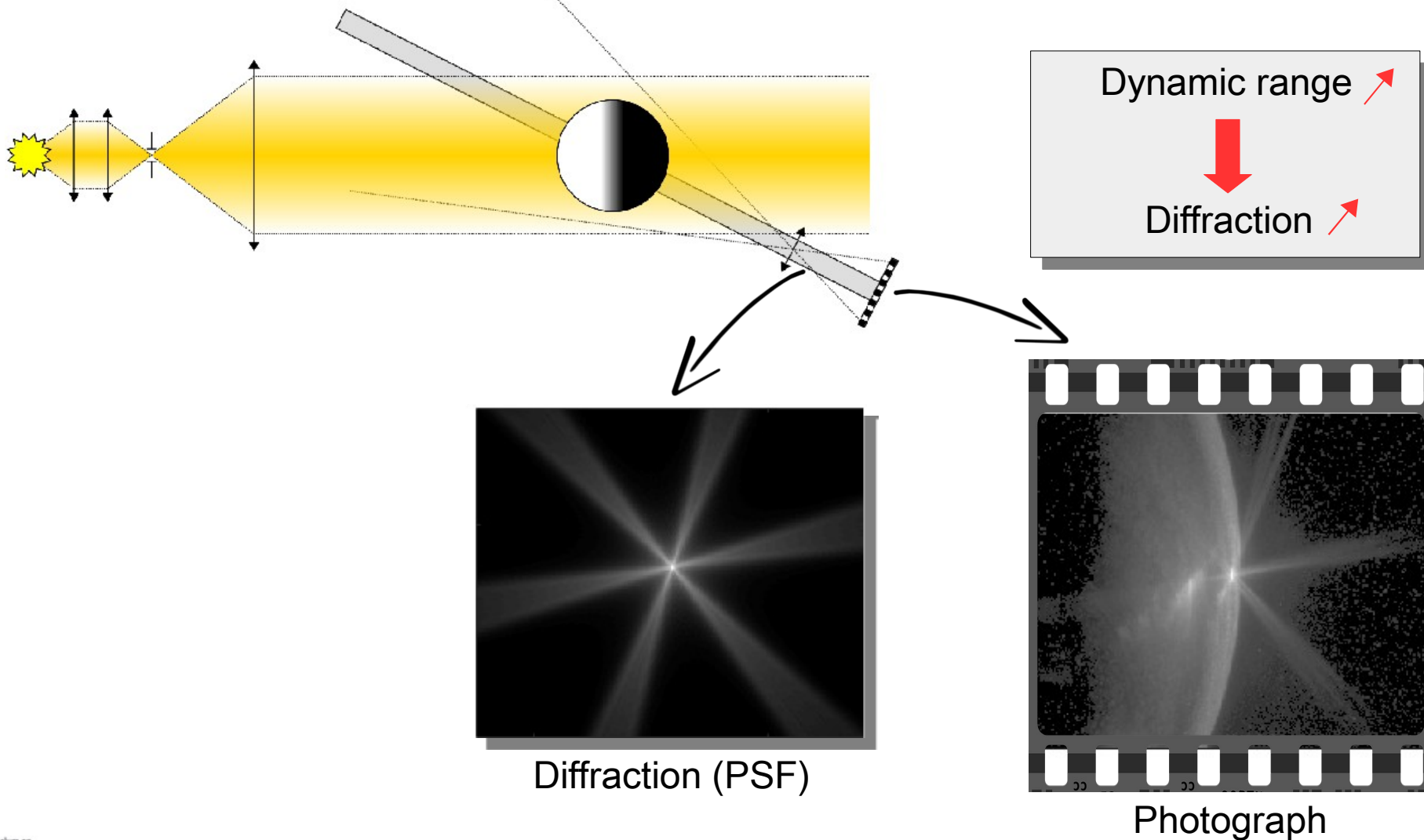

Diffraction : an Image Space Bias

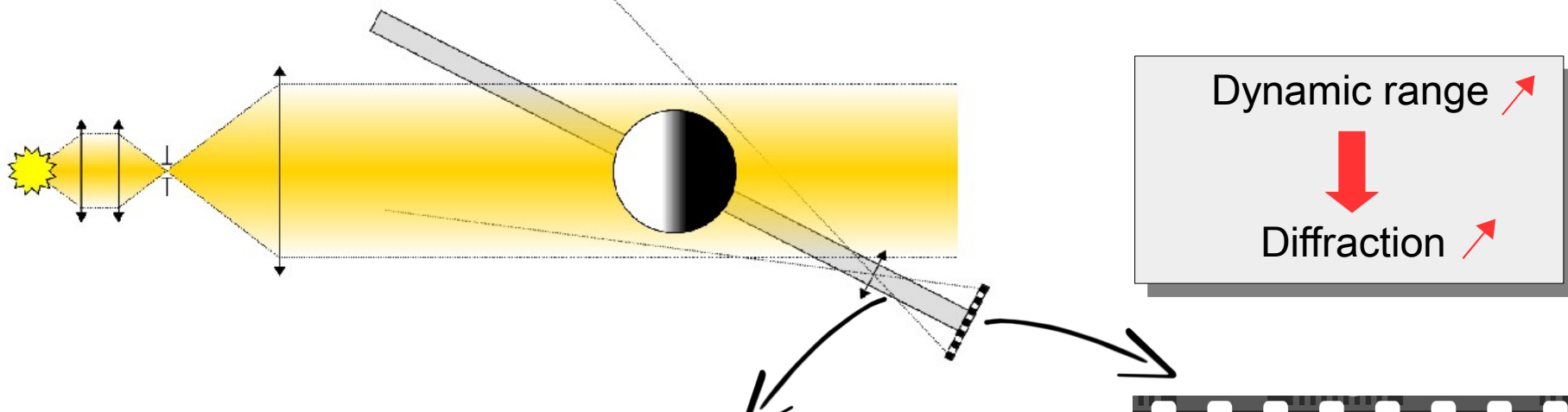

Ideal image

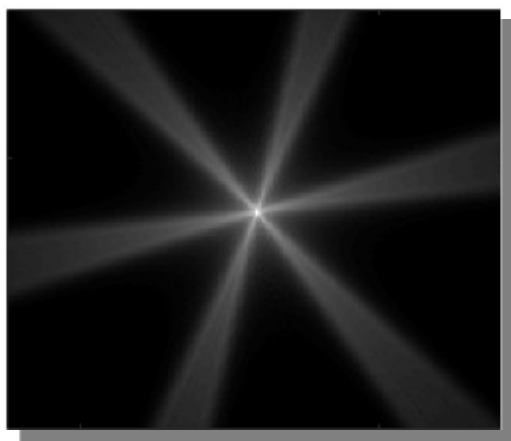
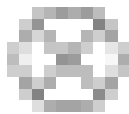

Diffraction (PSF)

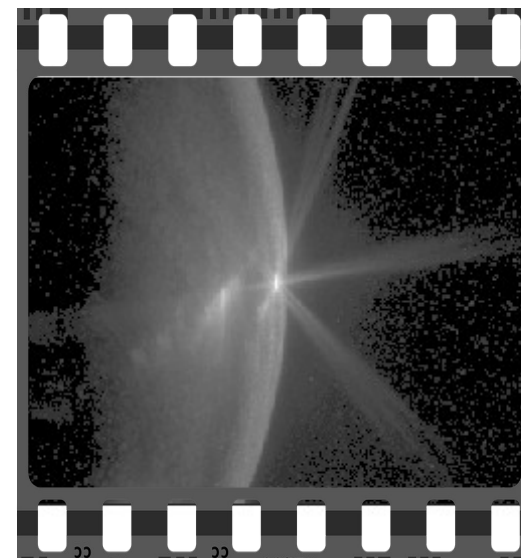

Photograph

Diffraction : an Image Space Bias

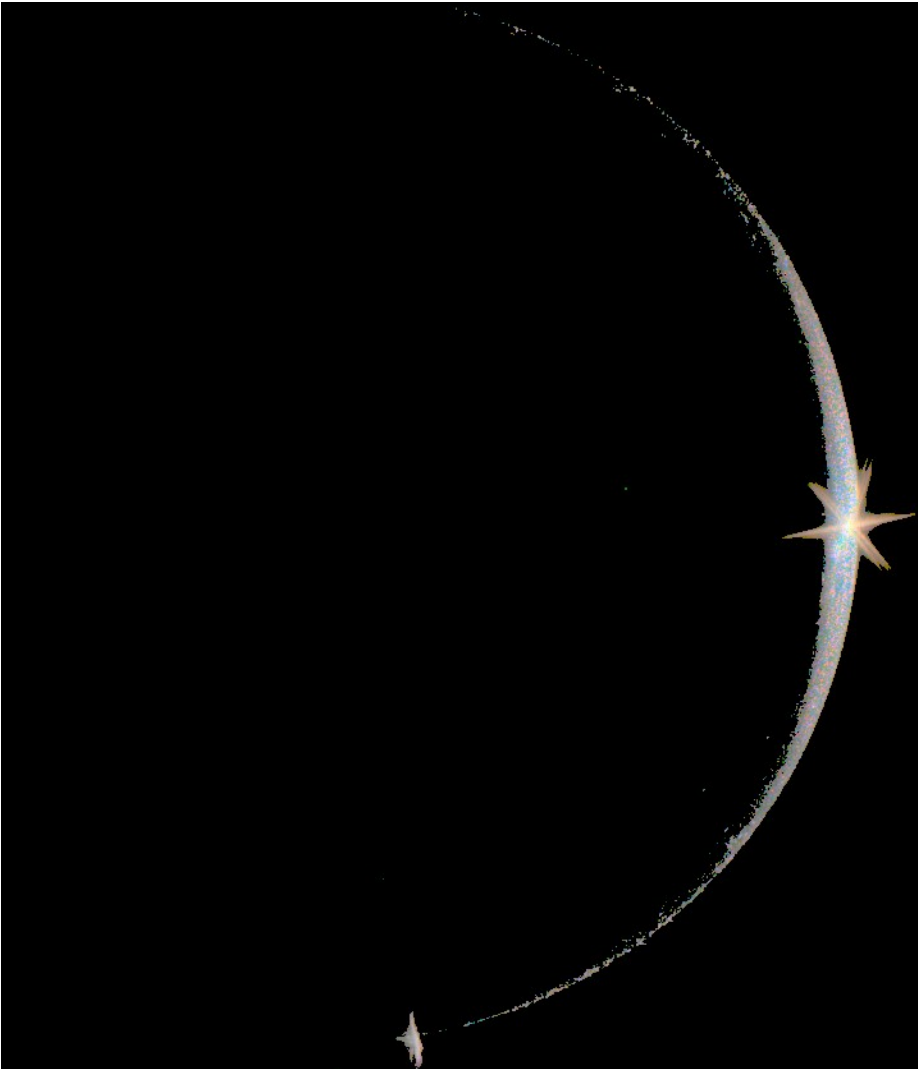

✘ Unreliable measurement

✘ Deconvolutions → loose track of uncertainties

Diffraction Removal Algorithm

Measurement by the setup :

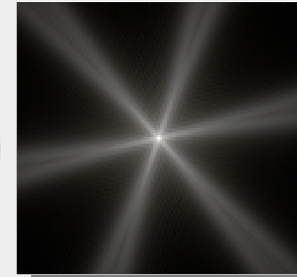

Diffraction Removal Algorithm

Measurement by the setup :

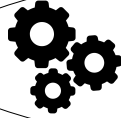
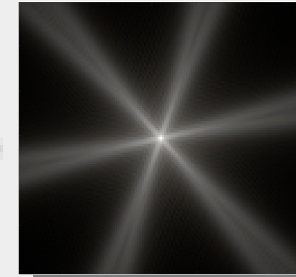

Find & Remove pixels
affected by diffraction *[Lucat17]*

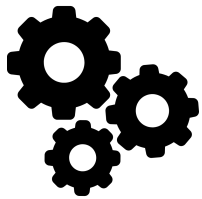

Diffraction Removal Algorithm

[Lucat17]



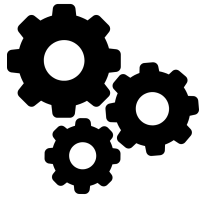

[Lucat17]

Diffraction Removal Algorithm

Main principle:

« If a *pixel* is *not modified* during our simulated diffraction, it was also *not* the case during the physical *diffraction* »



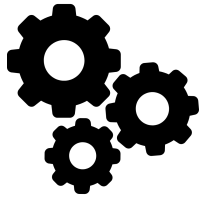

[Lucat17]

Diffraction Removal Algorithm

Main principle:
 « If a pixel is not modified during the physical simulation, it was also not the case during the physical simulation »

Not always true



Residual diffraction kernel

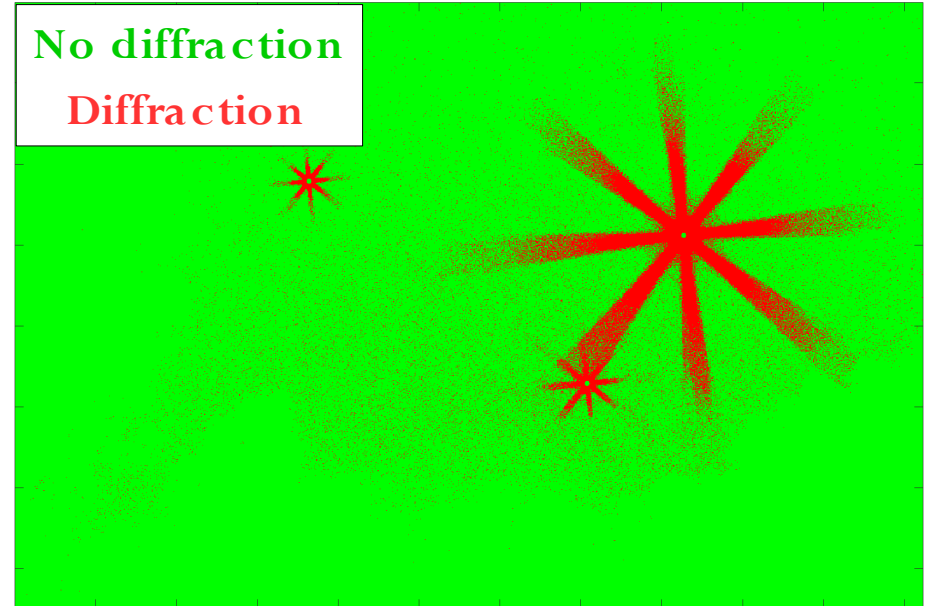

Diffraction Removal Algorithm

Measurement by the setup :

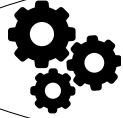
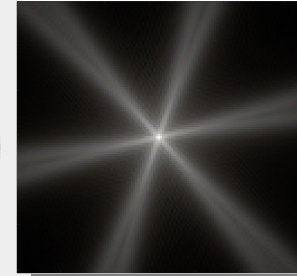

Find & Remove pixels
affected by diffraction [Lucat17]

Measurement by a « virtual » setup :

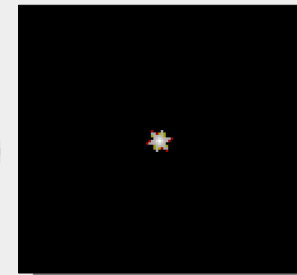

Diffraction Removal Algorithm

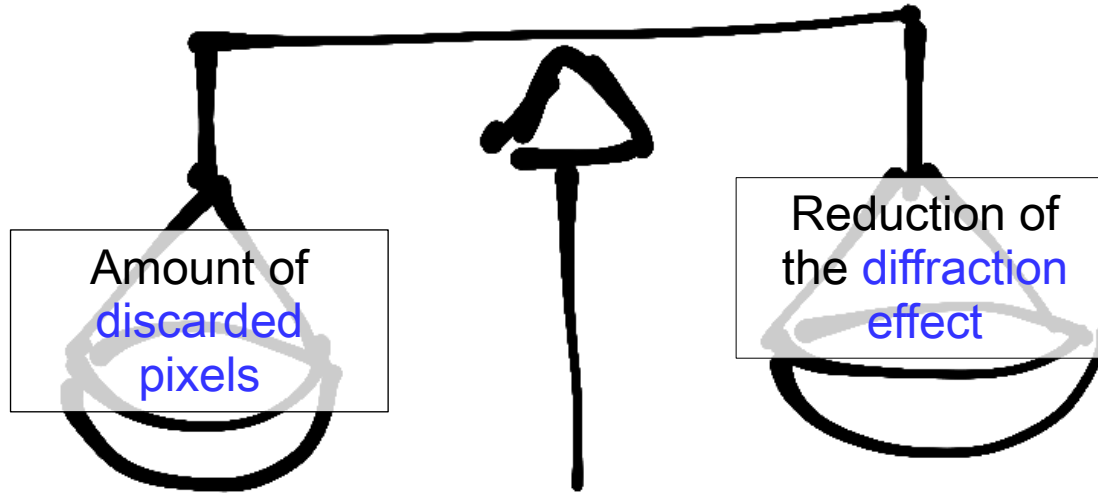

Measurement by a « virtual » setup :

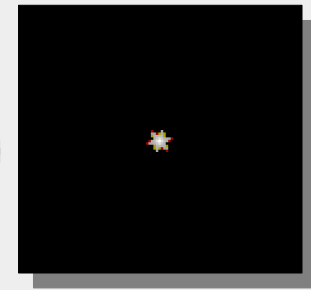

Pixel Remaining in Measurements

- ✓ More reliable measurement
- ✓ Keep track of uncertainties

Star-burst removal

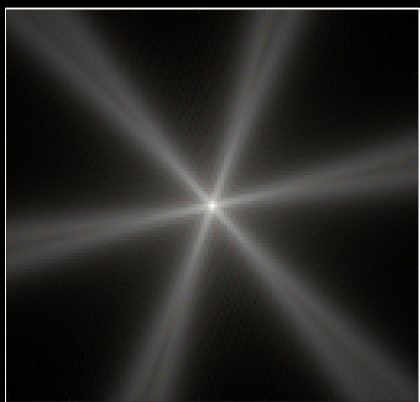

Diffraction
kernel



Residual
kernel

Results

Discarded Pixels Location

Camera acquisition

Discarded pixels

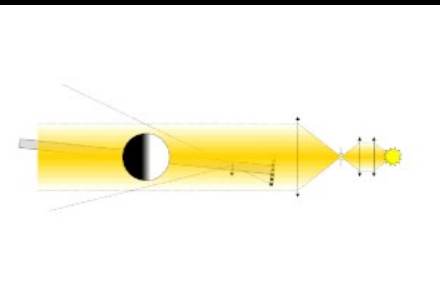

Discarded around **high image contrast** areas
Centers of highlights conserved

Results

Specularity & Configuration Loss

Grazing incidence

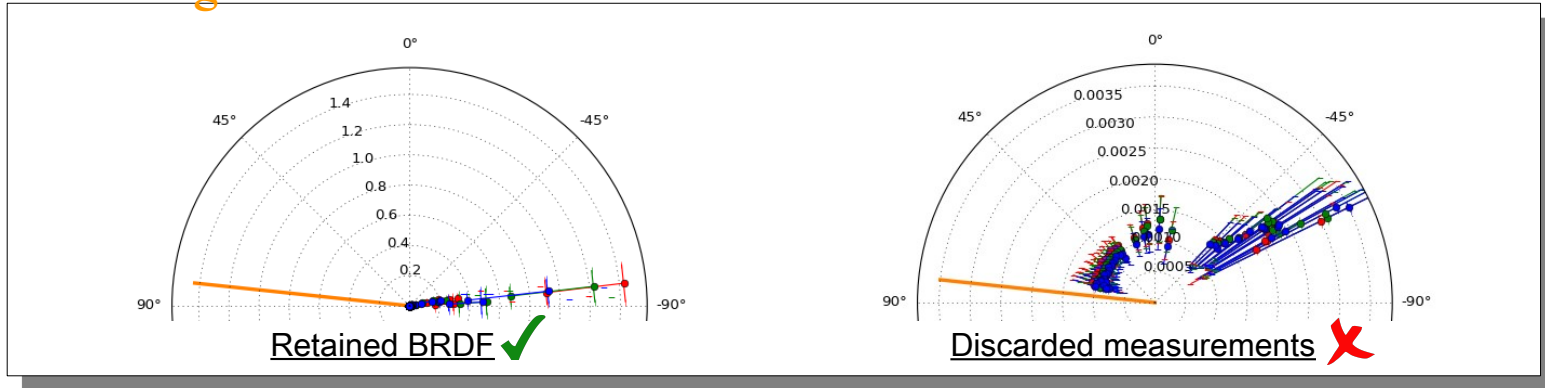

Specular peak

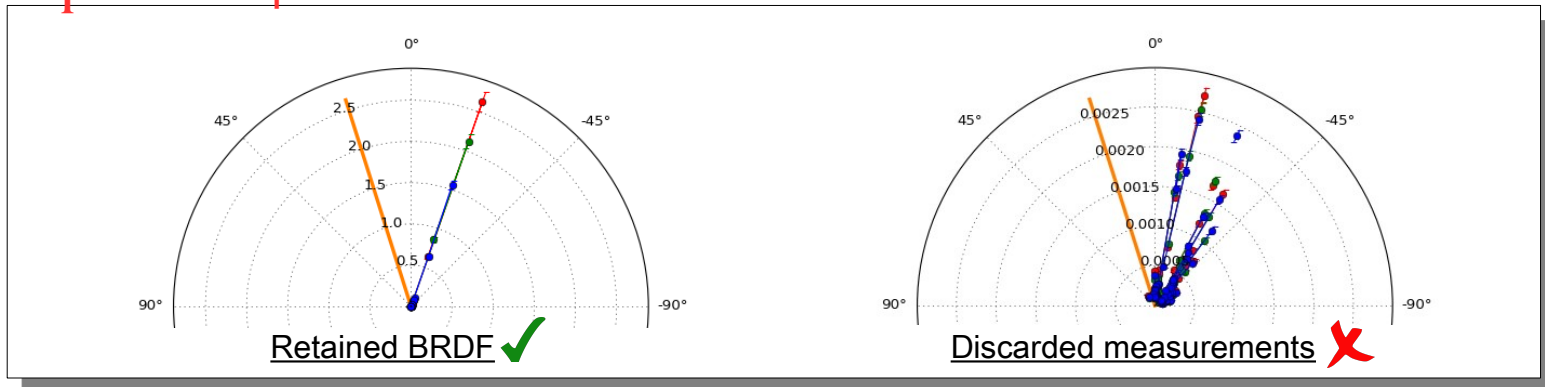

Results

Specularity & Configuration Loss

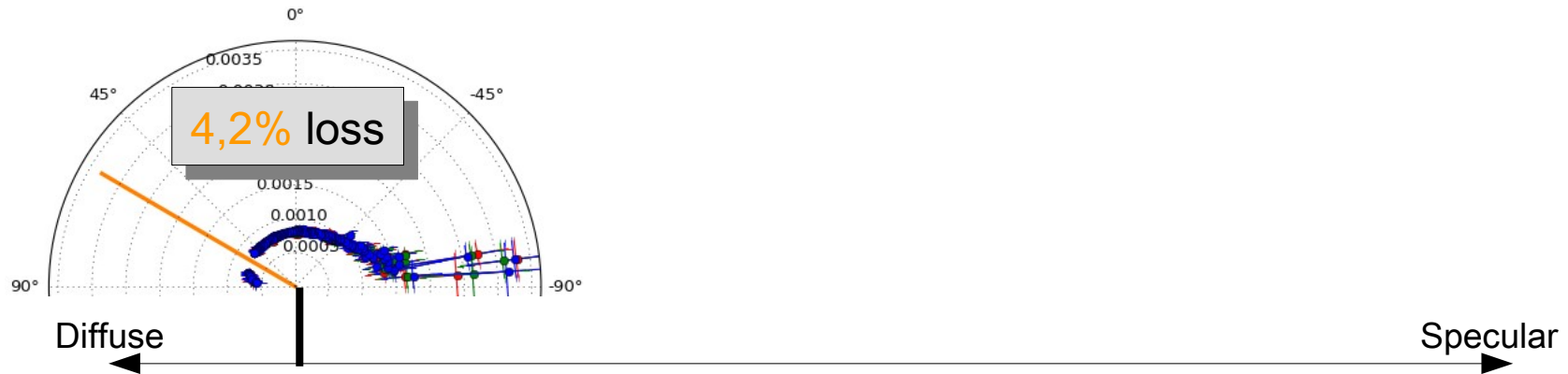

Results

Specularity & Configuration Loss

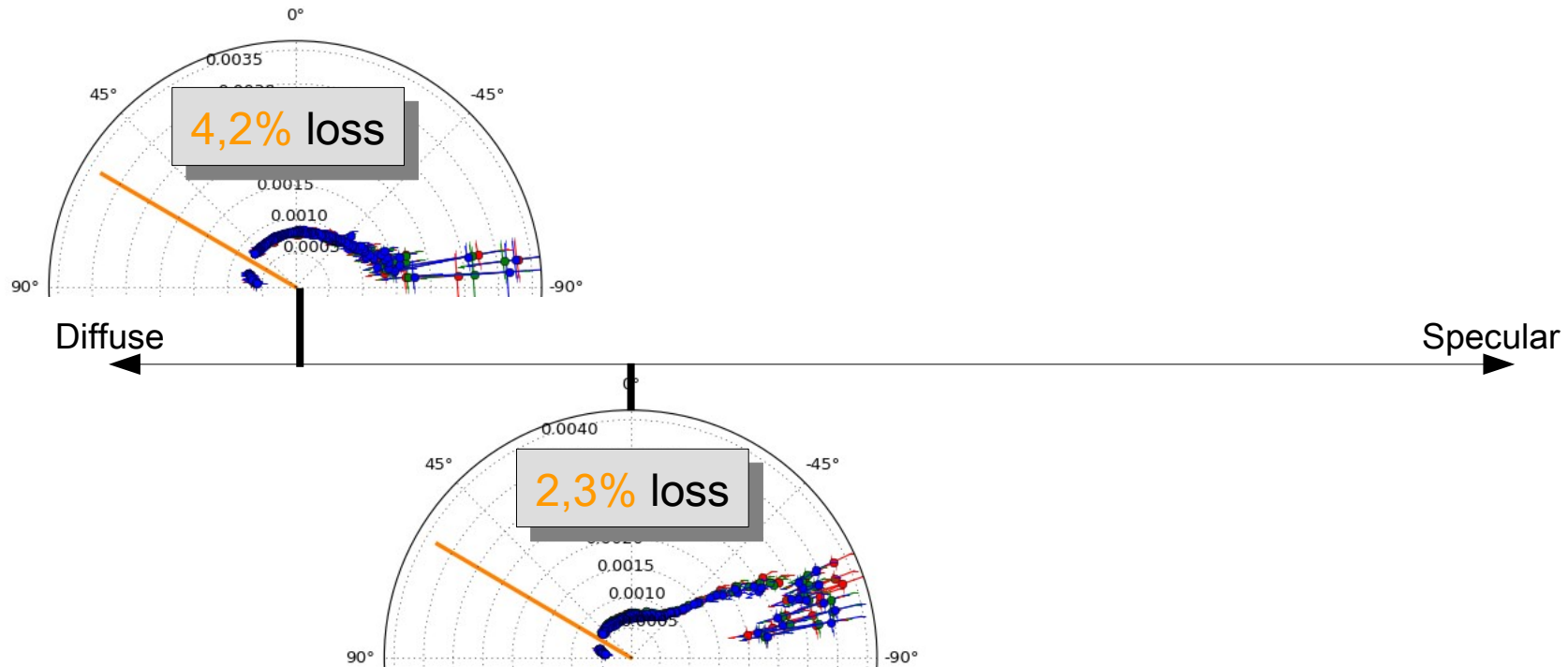

Results

Specularity & Configuration Loss

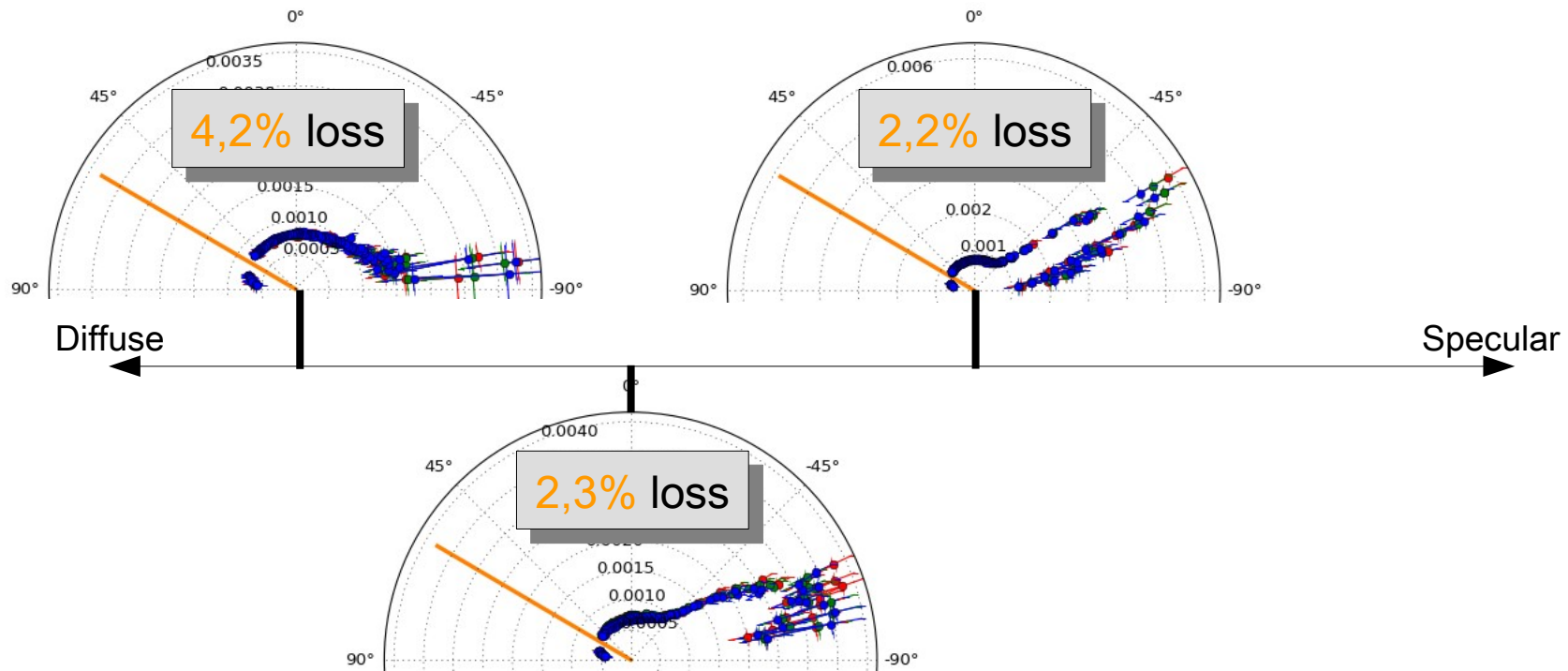

Results

Specularity & Configuration Loss

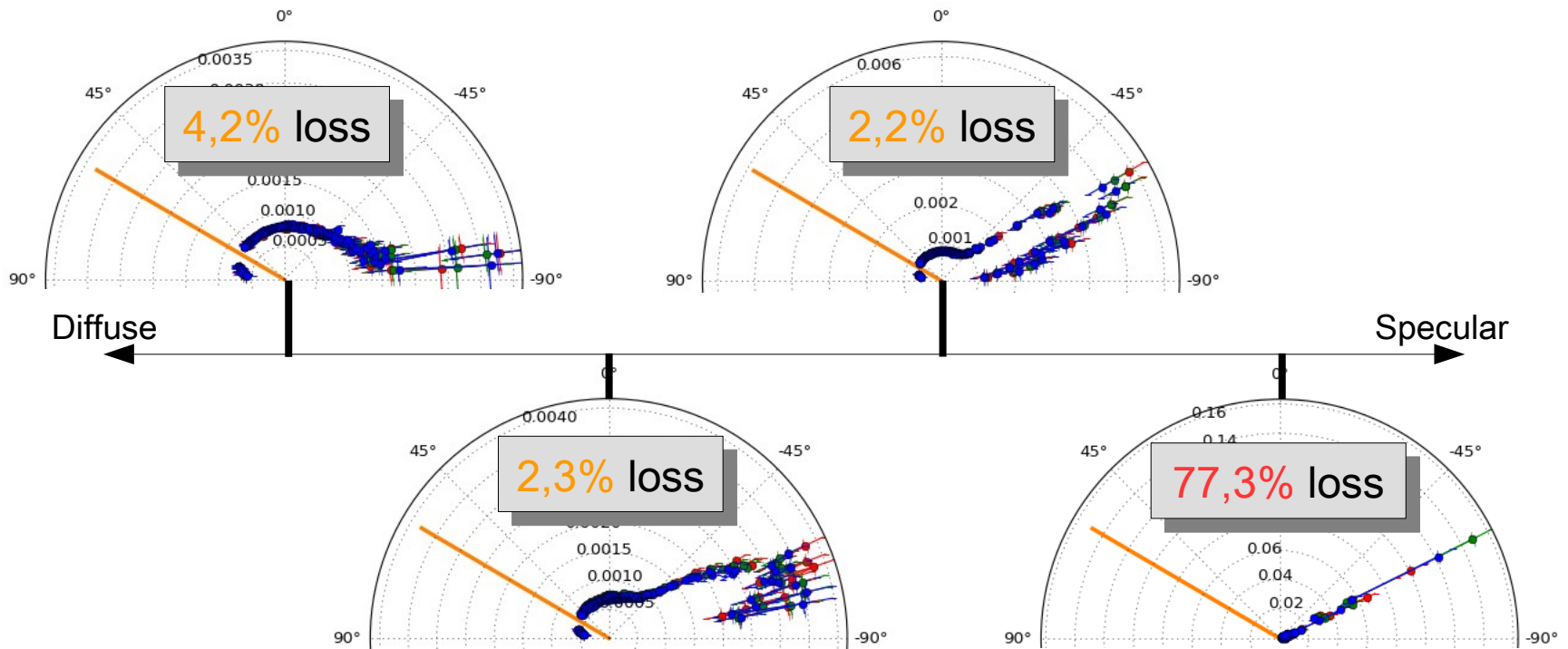

Results

Specularity & Configuration Loss

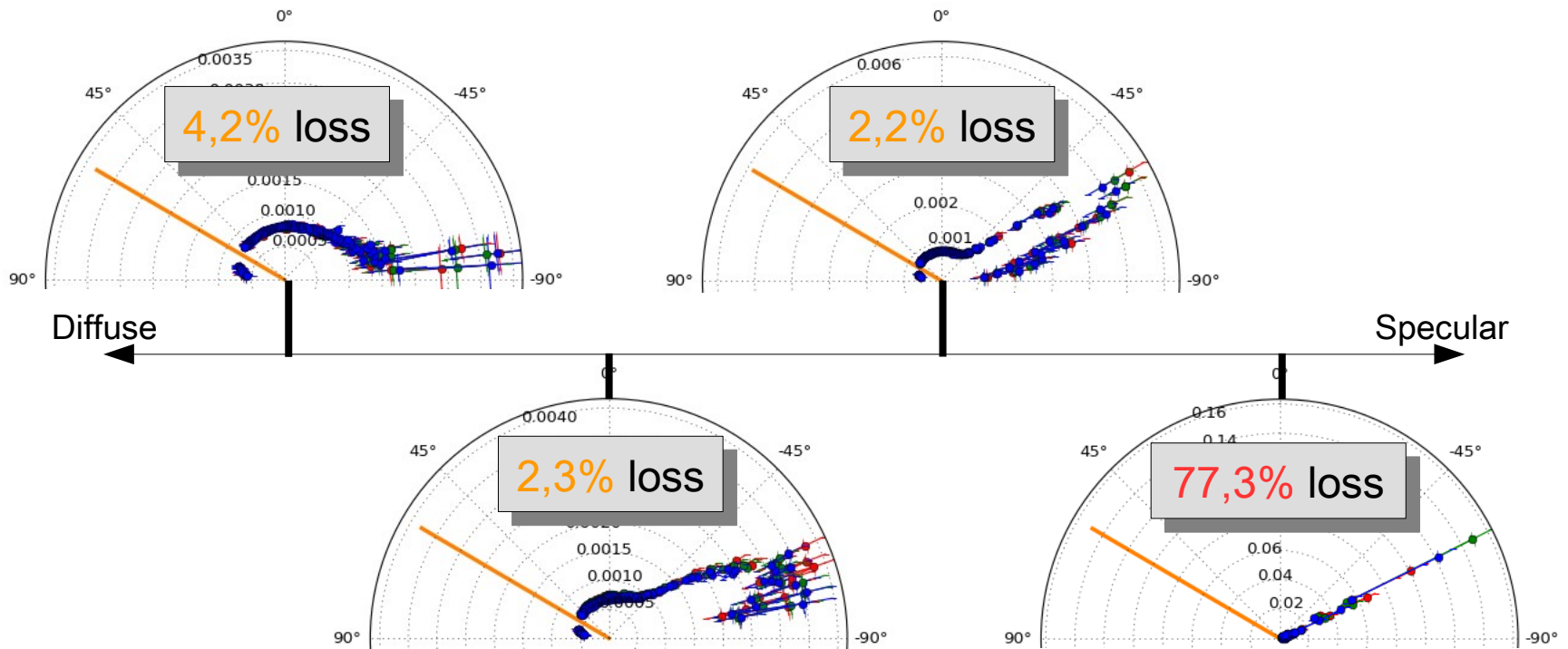

Grazing incidence → for each measurement

Specular peak → If peak smaller than the diffraction kernel

Dealing with a Measurement

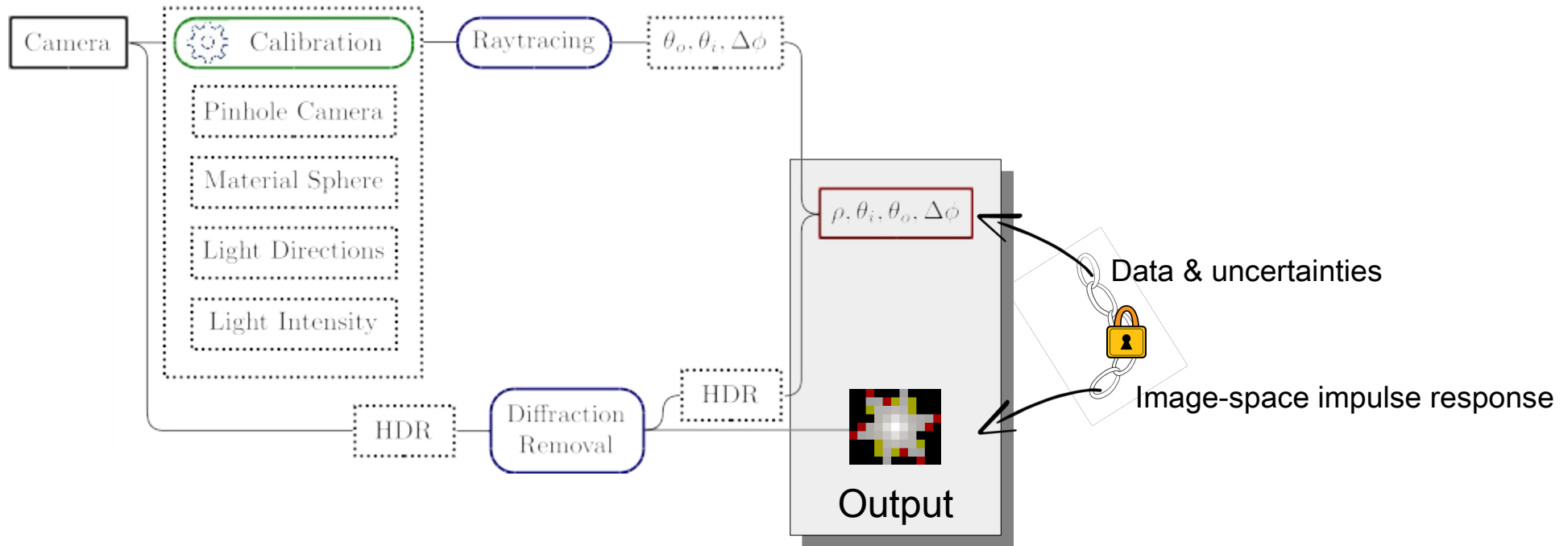

Data & Setup are **connected** (especially for specular materials)

Future Work

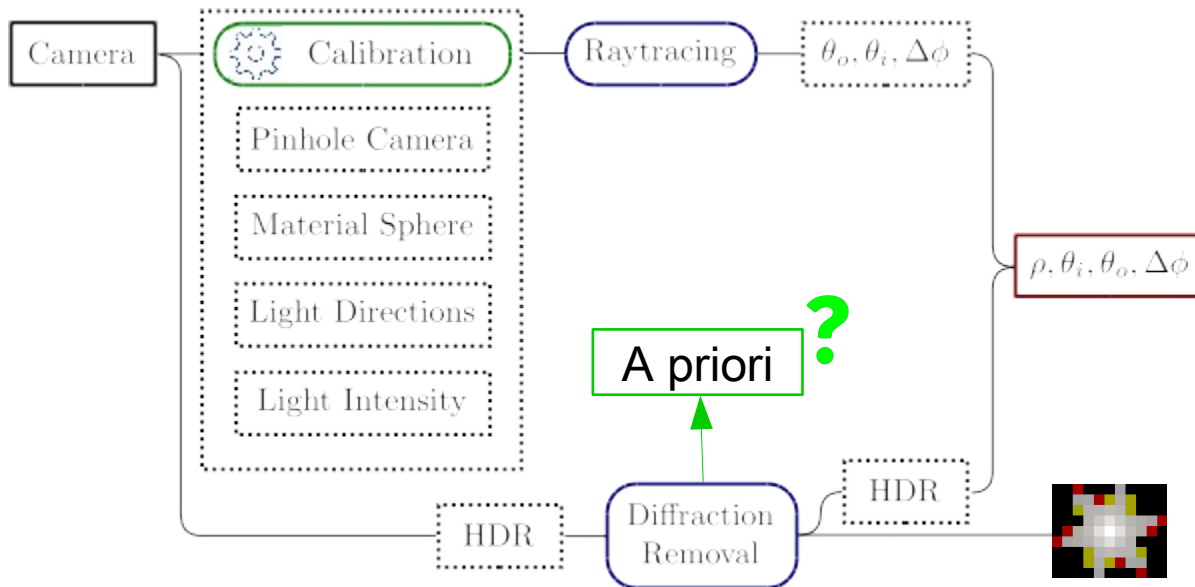

? Exploiting discarded configurations → give a priori

Advantages

- Good for fitting and modelling of BRDFs ✓

Future Work

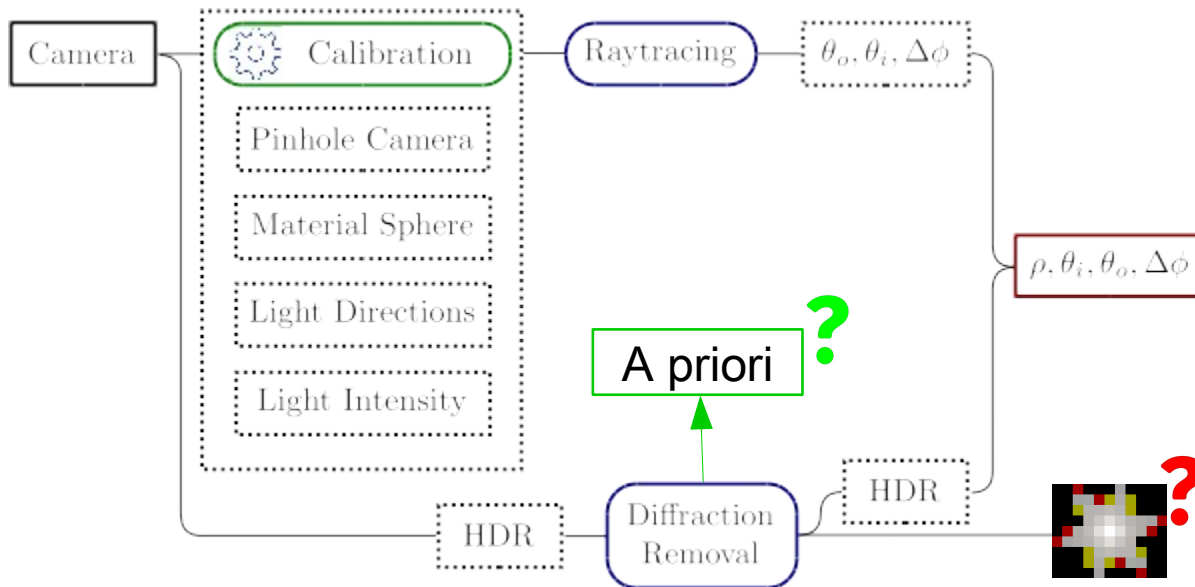

? Exploiting discarded configurations → give a priori

? Image-space kernel → BRDF-space kernel

Advantages

- Good for fitting ✓
- Measurement / Setup separation ✓
- Easier use of the data ✓

Future Work

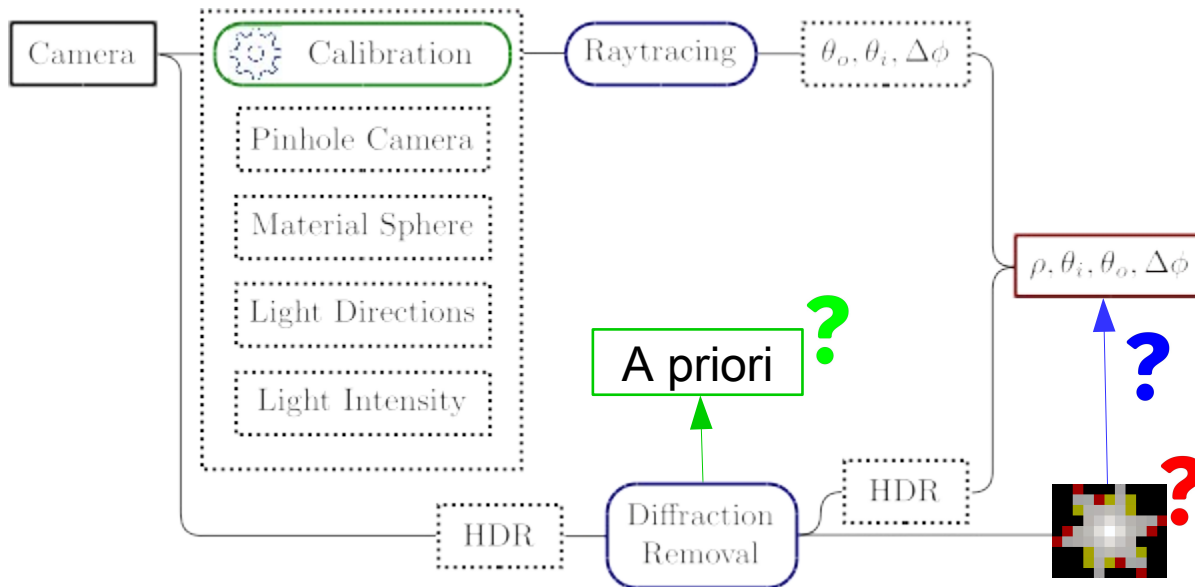

? Exploiting discarded configurations → give a priori

? Image-space kernel → BRDF-space kernel

? Insert the kernel into uncertainties

Advantages

- Good for fitting ✓✓
- Measurement / Setup separation ✓
- Easier use of the data ✓✓

Conclusion

BRDF measurement setup **capabilities are limited by diffraction** far beyond the common Rayleigh criterion

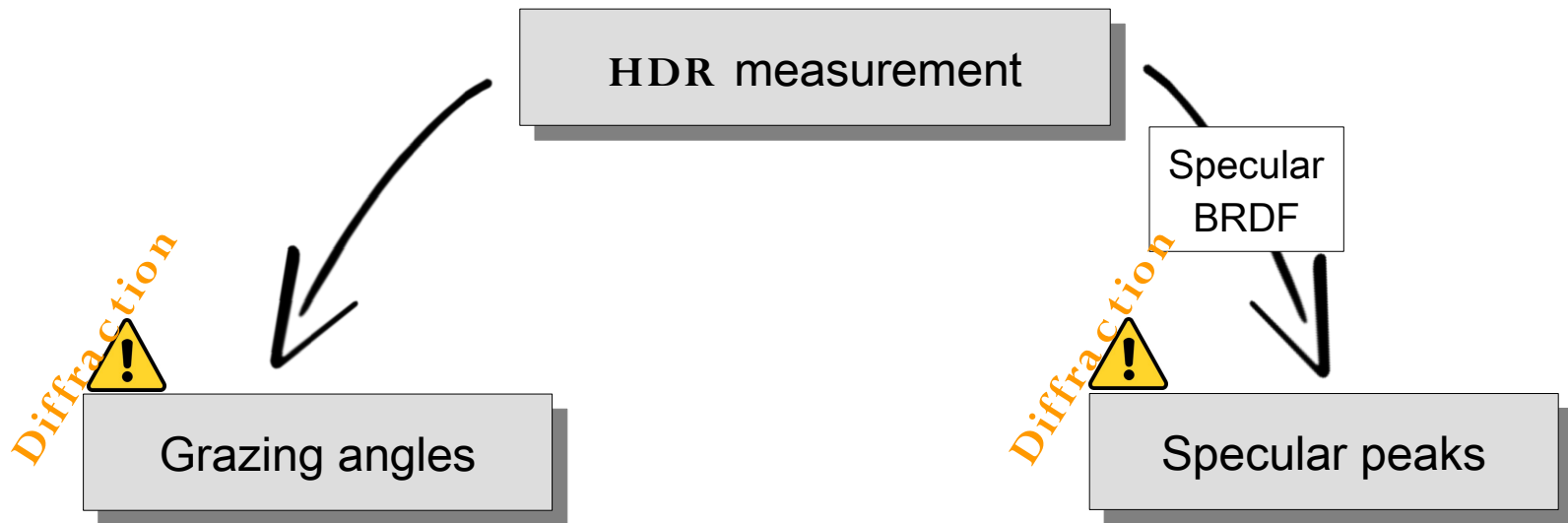
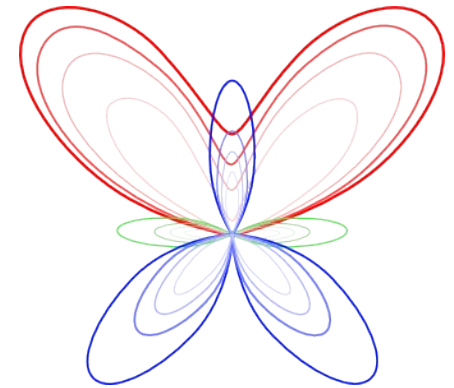

Image-based setups are **not suited for these** material **configurations**

Thank you for your attention

Data will be released on ALTA:
<http://alta.gforge.inria.fr/data.html>



References

- [Matusik03]
Matusik W., Pfister H., Brand M., McMillan L. : Efficient isotropic BRDF measurement. In Proc. EGWR '03 (2003), pp. 241-247.
- [Marschner98]
Marschner S.R., Westin S.H., Lafortune E.P.F., Torrance K.E., Greenberg D.P. : Image-Based BRDF Measurement Including Human Skin. In Proc. of 10th Eurographics Workshop on Rendering, p.139-152, June 1999.
- [Lucat17]
Lucat A., Hegedus., and Pacanowski R. : Diffraction Effects Detection for HDR Image-Based Measurements. Opt. Express 25, 27146-27164 (2017).
- [Farrance12]
Farrance I., Frenkel R. : Uncertainty of Measurement: A Review of the Rules for Calculating Uncertainty Components through Functional Relationships. The Clinical Biochemist Reviews, 2012;33(2):49-75.

Correlations

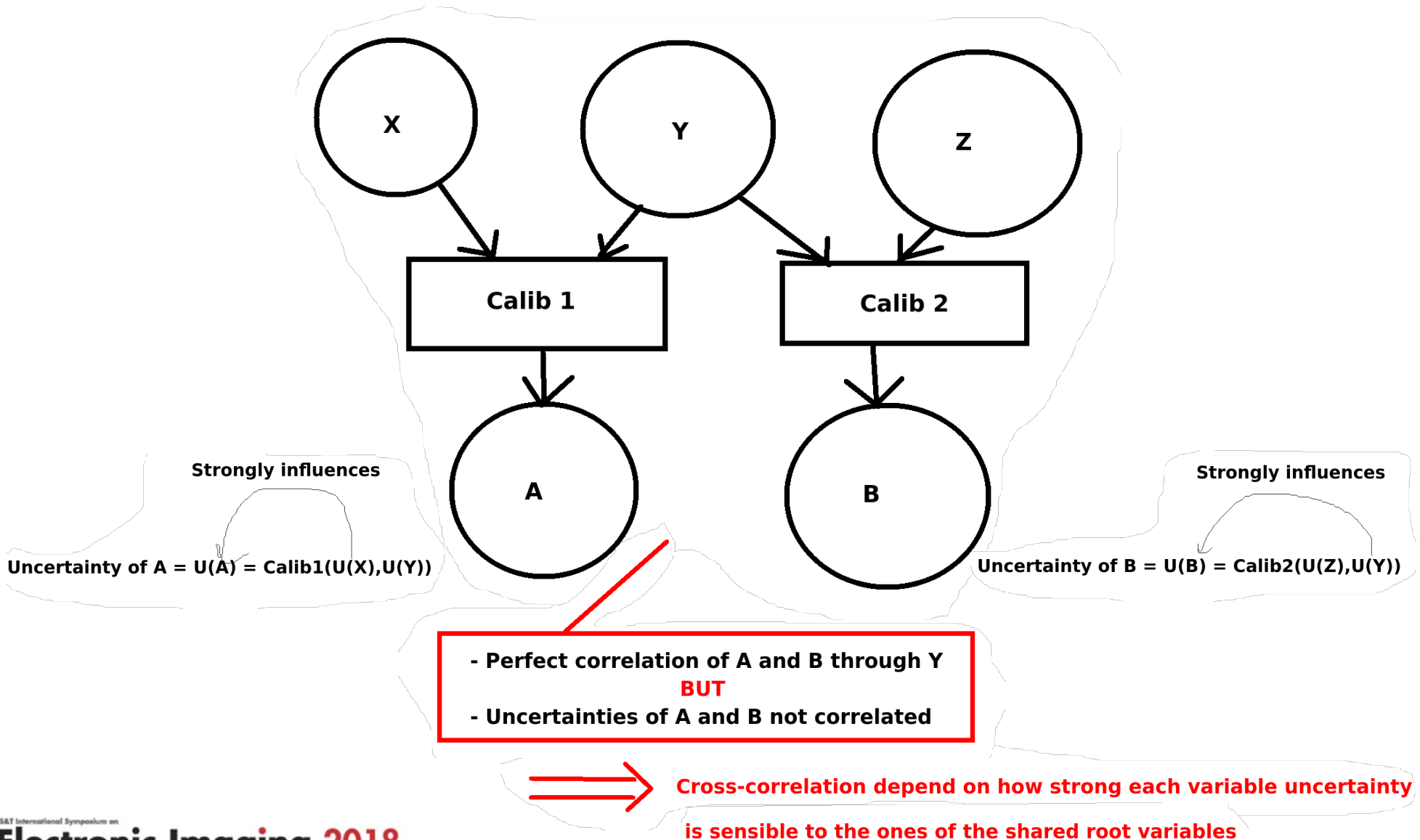

Correlations

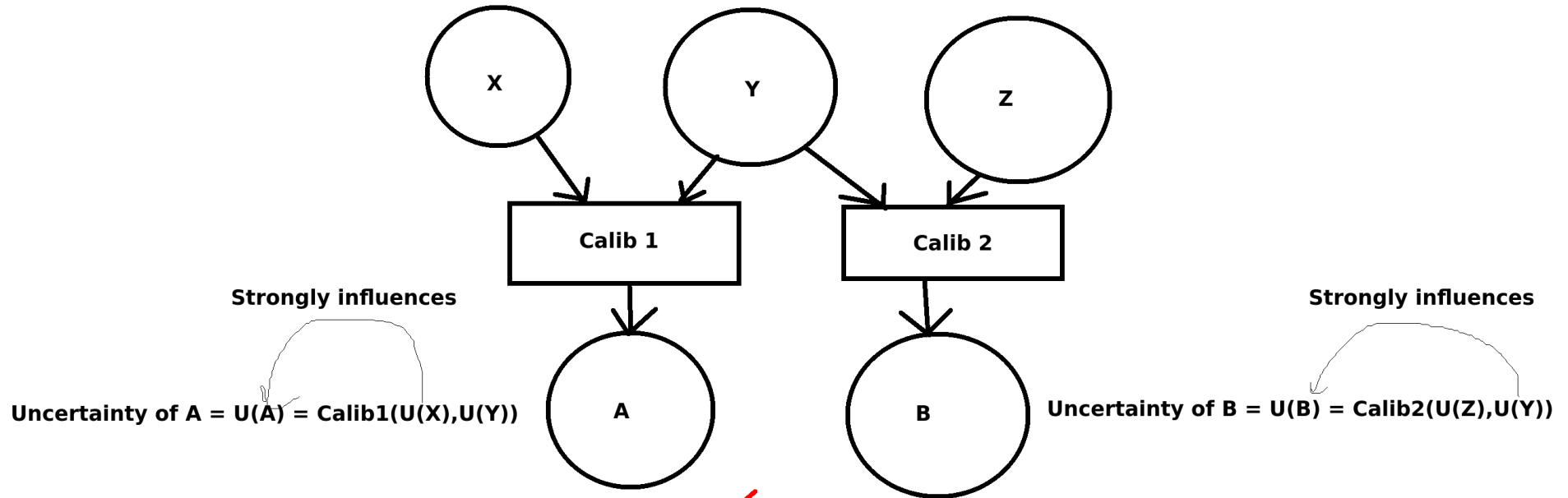

- Perfect correlation of A and B through Y
- BUT**
- Uncertainties of A and B not correlated



Cross-correlation depend on how strong each variable uncertainty is sensible to the ones of the shared root variables