



HAL
open science

Space Debris Removal using a Tether: A Model

Pedro Velez, Tala Atie, Daniel Alazard, Christelle Cumer

► **To cite this version:**

Pedro Velez, Tala Atie, Daniel Alazard, Christelle Cumer. Space Debris Removal using a Tether: A Model. IFAC World Congress 2017, Jul 2017, Toulouse, France. pp. 7247-7252, 10.1016/j.ifacol.2017.08.1373 . hal-01738167

HAL Id: hal-01738167

<https://hal.science/hal-01738167>

Submitted on 20 Mar 2018

HAL is a multi-disciplinary open access archive for the deposit and dissemination of scientific research documents, whether they are published or not. The documents may come from teaching and research institutions in France or abroad, or from public or private research centers.

L'archive ouverte pluridisciplinaire **HAL**, est destinée au dépôt et à la diffusion de documents scientifiques de niveau recherche, publiés ou non, émanant des établissements d'enseignement et de recherche français ou étrangers, des laboratoires publics ou privés.



Open Archive Toulouse Archive Ouverte (OATAO)

OATAO is an open access repository that collects the work of some Toulouse researchers and makes it freely available over the web where possible.

This is an author's version published in: <https://oatao.univ-toulouse.fr/19592>

Official URL : <http://dx.doi.org/10.1016/j.ifacol.2017.08.1373>

To cite this version :

Velez, Pedro and Atie, Tala and Alazard, Daniel and Cumer, Christelle Space Debris Removal using a Tether: A Model. (2017) In: IFAC World Congress 2017, 9 July 2017 - 14 July 2017 (Toulouse, France).

Any correspondence concerning this service should be sent to the repository administrator:

tech-oatao@listes-diff.inp-toulouse.fr

Space Debris Removal using a Tether: A Model

Pedro Velez*, Tala Atie**, Daniel Alazard***,
Christelle Cumer****

* MSc. Student, ISAE-SUPAERO, 10 Avenue Edouard Belin, 31055
Toulouse, France (e-mail: pedro.garcia@isae.fr)

** MSc. Student, ISAE-SUPAERO (e-mail: tala.atie@isae.fr)

*** Professor, ISAE-SUPAERO (e-mail: alazard@isae.fr)

**** Research Scientist, ONERA, 2 Avenue Edouard Belin, 31055
Toulouse, France (e-mail: christelle.cumer@onera.fr)

Abstract: Focused on the removal of space debris, this paper studies the modeling of a target satellite connected to a chaser satellite by a tether. All dynamic couplings between the flexible and rigid modes of the satellites are accounted for. The tether attached to both satellites is modeled as a massless spring when stretched and non-existent when compressed. The objective of this work is to model the behaviour of the three bodies: chaser, tether, and target in the orbital reference frame for arbitrary initial conditions of the target satellite. Simulations of the whole system including the chaser Attitude and Orbit Control System (AOCS) are performed to evaluate its ability to damp the debris tumbling motion and to tow the debris.

Keywords: Satellite, Space, Debris, Tether, Modeling, Attitude, Control.

NOMENCLATURE

G_c	: Center of mass of the chaser satellite.
G_t	: Center of mass of the target satellite.
P_c	: Tether connection point with the chaser.
P_t	: Tether connection point with the target.
\mathcal{R}_{G_c}	: Body reference frame attached to the chaser satellite, with origin at point G_c .
\mathcal{R}_{G_t}	: Body reference frame attached to the target satellite, with origin at point G_t .
\mathcal{R}_O	: Orbital reference frame, with origin at point O .
I_n	: Identity matrix of dimension $n \times n$.
$0_{n \times m}$: Null matrix of dimension $n \times m$.
s	: Laplace variable.
$\left. \frac{d\mathbf{X}}{dt} \right _{\mathcal{R}}$: Time-derivation of vector \mathbf{X} in frame \mathcal{R} .
$[\cdot]_{\mathcal{R}}$: Matrix or vector projected in frame \mathcal{R} .
$\mathbf{a}_A, \mathbf{V}_A$: inertial acceleration and velocity of point A.
τ_{AB}	: Kinematic model between the point A and the point B.

$$\tau_{AB} = \begin{bmatrix} I_3 & (*\mathbf{AB}) \\ 0_{3 \times 3} & I_3 \end{bmatrix}$$

$(*\mathbf{AB})$: Antisymmetric matrix associated to \mathbf{AB} .
If $\mathbf{AB} = [x, y, z]_{\mathcal{R}}^T$, then

$$(*\mathbf{AB}) = \begin{bmatrix} 0 & -z & y \\ z & 0 & -x \\ -y & x & 0 \end{bmatrix}_{\mathcal{R}}$$

1. INTRODUCTION

In order to maintain a future for satellite activity, it is imperative to preserve space environment of Earth. As more debris have been accumulating in space from dysfunctional satellites and pieces of destroyed satellites, functioning satellites have become endangered by the threat of collision imposed by the debris clouds (Johnson, 2010). This was the case in 2009 when an active American satellite (Iridium) collided with a dysfunctional Russian military satellite (Ansdell, 2010). Thus has risen the need to remove debris from the vicinity of Earth. Among many studies, methods and developments in that field, one way to deal with this problem is through a chaser towing the debris with a tether into re-entry (Fig. 1). The focus of this paper is to model the system of two satellites connected by a tether as accurately as possible. This work can be compared to the past work of (Jasper et al., 2012), who considered chaser and target as point masses, and of (Aslanov and Yudinsev, 2015), who modeled the chaser as a rigid point mass. Their models are a special case of the model of this paper which takes into account any kind of flexible modes. Furthermore, the connection point between the chaser (respectively target) and the tether is not located at the center of mass of the satellites, and will thus create couplings between the translational and rotational motions. This requires modeling the tether's motion at the tether's tips.

A toolbox to model the linear behavior of the couplings between the rigid and flexible modes of a satellite was established in (Alazard et al., 2008). It takes as input a vector of applied forces and torques and gives as output the translational and rotational accelerations of the satellite. This paper adopts that model for the satellites. The

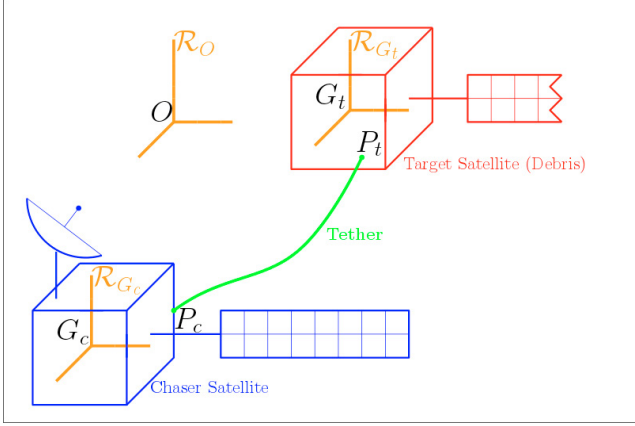

Fig. 1. Chaser and target satellites connected by a tether

tether is modeled as an elastic, when stretched. It then combines the dynamics of the three bodies to determine the behavior of the entire system in response to an applied force or torque at the chaser. The paper models the linear behaviour of each flexible satellite since the non-linear terms are negligible for small satellite angular velocity. However, it accounts the non-linear coriolis and centrifugal terms in the double integration of the acceleration at the connection points of the tether and satellites. This gives the true attitude of the satellites and the exact motion of points P_c and P_t at the tips of the tether. Three frames of reference are needed to correctly model this system:

- two body reference frames: \mathcal{R}_{G_c} and \mathcal{R}_{G_t} , the first one attached to the chaser, the other one to the target. Their origins are the centers of mass of the hubs (G_c and G_t) of the corresponding satellites.
- one orbital reference frame: \mathcal{R}_O , in relation to which all other body frames, positions and velocities will be defined. This reference frame is assumed to be inertial in this study.

In the sequel, subscripts c and t will be omitted for general formulae, which are valid for both satellites.

2. MODELING

2.1 Satellite Dynamics Toolbox (SDT)

In order to model the connected system the satellite models are obtained by the Satellite Dynamics Toolbox. This toolbox is explained in (Alazard et al., 2008) and can be found in (Alazard and Cumer, 2014). The SDT assumes the satellite to be formed of 2 kinds of components: a rigid body (the hub), and flexible (or rigid) appendages (could be 1 or more or even none). The satellite dynamics results in the couplings of flexible modes coming from the appendage(s) and rigid modes coming from the hub. From geometrical and mechanical data of the satellite, the toolbox gives a minimal state-space representation of the overall dynamic model at the center of mass G and projected in the body frame. The 6x1 input vector of this model is composed by external forces and torques (wrench vector) $[\mathbf{F}_{ext}^T \mathbf{T}_{ext,G}^T]_{\mathcal{R}_G}^T$ and the 6x1 output vector is composed by the linear and angular accelerations (derivative of the twist vector) $[\mathbf{a}_G^T \dot{\boldsymbol{\omega}}^T]_{\mathcal{R}_G}^T$:

$$\begin{bmatrix} \mathbf{a}_G \\ \dot{\boldsymbol{\omega}} \end{bmatrix}_{\mathcal{R}_G} = [\mathbf{D}_G^{sat}]^{-1}(s) \begin{bmatrix} \mathbf{F}_{ext} \\ \mathbf{T}_{ext,G} \end{bmatrix}_{\mathcal{R}_G} \quad (1)$$

Although very practical and easy to use, one must remember that the SDT only provides a linear model.

Frame Transformation: The target body frame (\mathcal{R}_{G_t}) and the chaser body frame (\mathcal{R}_{G_c}) are required since the SDT uses inputs and outputs in these frames, while the orbital frame (\mathcal{R}_O) will be used as a global reference in order to compare the positions and obtain the dynamics of the tether. The frame transformations are the usual Euler angles transformations 3-2-1, using the attitude angles ϕ , θ and ψ of each satellite. $\mathbf{T}_{\mathcal{R}_O \rightarrow \mathcal{R}_G}$ denotes the frame transformation from the orbital frame to the body frame.

Translation of the Model: In (Alazard et al., 2008) it was demonstrated that the linear dynamics model of the whole system can be modeled by the feedbacks of the direct dynamic models of each appendage on the inverse dynamic model of the hub. The whole model can then be built using substructuring techniques and is appropriated for parametric sensitivity analysis (Guy et al., 2014). A multi-body modeling approach was chosen and, therefore, in order to add the dynamics of several parts together, they all need to be modeled at the same point. Thus the

kinematic model $\tau_{PG} = \begin{bmatrix} I_3 & (*PG) \\ 0 & I_3 \end{bmatrix}$ allows the dynamic model to be translated from point G (or any other point) to P in the same reference frame. It neglects all non-linear terms. Since the tether applies a force on each satellite at its connection point (P) and yet each satellite is modeled at the center of mass of the hub (G), τ_{PG} is used to transport the wrench applied by the tether at point P to point G :

$$\begin{bmatrix} \mathbf{F}_{ext} \\ \mathbf{T}_{ext,G} \end{bmatrix} = \tau_{PG}^T \begin{bmatrix} \mathbf{F}_{ext} \\ \mathbf{T}_{ext,P} \end{bmatrix} \quad (2)$$

In the SDT, τ_{PG} is also used to transport the acceleration twist from G to P :

$$\begin{bmatrix} \mathbf{a}_P \\ \dot{\boldsymbol{\omega}} \end{bmatrix} = \tau_{PG} \begin{bmatrix} \mathbf{a}_G \\ \dot{\boldsymbol{\omega}} \end{bmatrix} \quad (3)$$

but non-linear terms in the computation of accelerations are neglected.

2.2 Connection of Satellites

Tether Model: As the model is about studying the interaction between the two satellites, it is crucial to conveniently model the tether connecting them and its dynamics. The tether is cylindrical and treated as a massless spring when it is extended and as non-existent otherwise. It applies a symmetrical force on each extremity, being each one connected to one of the satellites. The orientation of the two forces is along $\mathbf{P}_c\mathbf{P}_t$ and these forces have opposite senses. The force delivered by the tether on the target is:

$$\begin{cases} \mathbf{F}_{tether} = -k(|\mathbf{P}_c\mathbf{P}_t| - l_0) \frac{\mathbf{P}_c\mathbf{P}_t}{|\mathbf{P}_c\mathbf{P}_t|}, & \text{if } |\mathbf{P}_c\mathbf{P}_t| > l_0 \\ \mathbf{F}_{tether} = 0, & \text{if } |\mathbf{P}_c\mathbf{P}_t| \leq l_0 \end{cases} \quad (4)$$

where l_0 is the natural length of the tether. The parameters influencing k will be the natural length (l_0), the area

(A)/diameter (d) of the cross section and the Young Modulus (E) of the material of the tether. The choice of the material and geometry of the tether is crucial because:

- There is a maximum force that the tether could take without breaking or losing its elasticity.
- As the control inputs of the two connected satellites are only located on the chaser, the tether must be conceived in order to transmit as quickly as possible the desired outputs on the target satellite.
- The dynamics of the tether creates vibrations on the system. The interaction of the stiffness with the flexible modes of the satellites and its effects must be assessed.

Inertial position and velocity of point P_c (resp. P_t): As mentioned in the introduction, the tether model requires the exact motions of points P_c and P_t . Equation (3) is no more valid. From the inertial acceleration twist at point G_c (resp. G_t) projected in frame \mathcal{R}_{G_c} (resp. \mathcal{R}_{G_t}), provided by the SDT, the objective is to develop a general procedure (a generic "block") to obtain :

- $[OP_c]_{\mathcal{R}_O}$ and $[OP_t]_{\mathcal{R}_O}$, required by the tether model,
- $[OG_c]_{\mathcal{R}_O}$ and $[OG_t]_{\mathcal{R}_O}$, required to monitor the satellites motion,
- $[V_{P_c}]_{\mathcal{R}_O}$, $[V_{G_c}]_{\mathcal{R}_O}$, $[V_{P_t}]_{\mathcal{R}_O}$, $[V_{G_t}]_{\mathcal{R}_O}$,
- p , q and r , the three components of the angular velocity vector of each satellite (expressed in each satellite frame) and the attitude angles ϕ , θ and ψ of each satellite,
- and $\mathbf{T}_{\mathcal{R}_O \rightarrow \mathcal{R}_G}$.

This block is depicted in Fig. 2 and is based on the following kinematic equations:

$$\mathbf{a}_G = \left. \frac{d\mathbf{V}_G}{dt} \right|_{\mathcal{R}_O} = \left. \frac{d\mathbf{V}_G}{dt} \right|_{\mathcal{R}_G} + \boldsymbol{\omega} \times \mathbf{V}_G \quad (5)$$

$$[\mathbf{V}_G]_{\mathcal{R}_G} = \int \left[\left. \frac{d\mathbf{V}_G}{dt} \right|_{\mathcal{R}_G} \right]_{\mathcal{R}_G} dt \quad (6)$$

$$\mathbf{V}_P = \mathbf{V}_G + \boldsymbol{\omega} \times \mathbf{G}P \quad (7)$$

$$\mathbf{V}_P = \left. \frac{dOP}{dt} \right|_{\mathcal{R}_O} = \left. \frac{dOP}{dt} \right|_{\mathcal{R}_G} + \boldsymbol{\omega} \times OP \quad (8)$$

$$[OP]_{\mathcal{R}_G} = \int \left[\left. \frac{dOP}{dt} \right|_{\mathcal{R}_G} \right]_{\mathcal{R}_G} dt \quad (9)$$

$$[OP]_{\mathcal{R}_O} = \mathbf{T}_{\mathcal{R}_O \rightarrow \mathcal{R}_G}^T [OP]_{\mathcal{R}_G} \quad (10)$$

$$\begin{bmatrix} \dot{\phi} \\ \dot{\theta} \\ \dot{\psi} \end{bmatrix} = \underbrace{\begin{bmatrix} 1 & \sin \phi \tan \theta & \cos \phi \tan \theta \\ 0 & \cos \phi & -\sin \phi \\ 0 & \sin \phi / \cos \theta & \cos \phi / \cos \theta \end{bmatrix}}_{\mathbf{f}(\phi, \theta, \psi)} \begin{bmatrix} p \\ q \\ r \end{bmatrix} \quad (11)$$

Overview of the Connected Model: A complete scheme of the model used to represent the two satellites connected by a tether is presented in Fig. 3. In a nutshell, the flow of the model consists of (see corresponding numbers in Fig. 3):

1. Transforming the tether force from the orbital frame (\mathcal{R}_O) to the satellite body frame (\mathcal{R}_{G_c} or \mathcal{R}_{G_t}).

$$\begin{bmatrix} \mathbf{F}^{\text{tether}} \\ \mathbf{0}_{3 \times 1} \end{bmatrix}_{\mathcal{R}_G} = T_{\mathcal{R}_O \rightarrow \mathcal{R}_G} \begin{bmatrix} \mathbf{F}^{\text{tether}} \\ \mathbf{0}_{3 \times 1} \end{bmatrix}_{\mathcal{R}_O}$$

2. Translating the system from point P (connection with tether) to point G (center of mass of the platform) in using (2).

3. For the chaser, adding the external force \mathbf{F}_{th}^c and torque \mathbf{T}_{rw, G_c}^c , due to the attitude and orbit control system : thruster (th) and reaction wheels (rw).

4. Computing with the Satellite Dynamics Toolbox the acceleration vector due to the forces applied to each satellite (in the body frame) (see (1)).

5. Integrating the accelerations to obtain the position and attitude of each satellite (as explained in the previous section).

6. Using the position of points P of the two satellites, compute the difference between the position of the two connection points in order to compute the distance between them.

$$[P_c P_t]_{\mathcal{R}_O} = [OP_t]_{\mathcal{R}_O} - [OP_c]_{\mathcal{R}_O}$$

7. Computing the force the tether applies (if stretched) - see (4).

8. Using the force computed (see (4)) as input for the target and its symmetrical as input for the chaser and looping to step 1.

3. CLOSED-LOOP SIMULATION

3.1 Chaser Attitude Controller

Controllers will now be added to control the behavior of the system. In a first phase, an attitude controller for the chaser satellite will be designed to control the behavior of the overall system. The target satellite is assumed to be passive and non cooperative, while the chaser is fitted with an active attitude and orbit control system (reaction wheels, thruster).

For this attitude control, a decentralized 3-axes PD controller was chosen, where Kp will be the 3 component vector (Kp_x, Kp_y, Kp_z) containing the proportional gains and Kv the 3 component vector (Kv_x, Kv_y, Kv_z) containing the derivative gains. The tuning of these parameters will be done assuming a rigid body dynamics and a dynamic decoupling between axes. Later, in the event of a flexible chaser satellite, a finer tuning can be done resorting to simulations.

For this section only, we will also assume the linearization: $(p, q, r) = (\dot{\phi}, \dot{\theta}, \dot{\psi})$. Under these assumptions, the following decoupled transfer functions can be deduced:

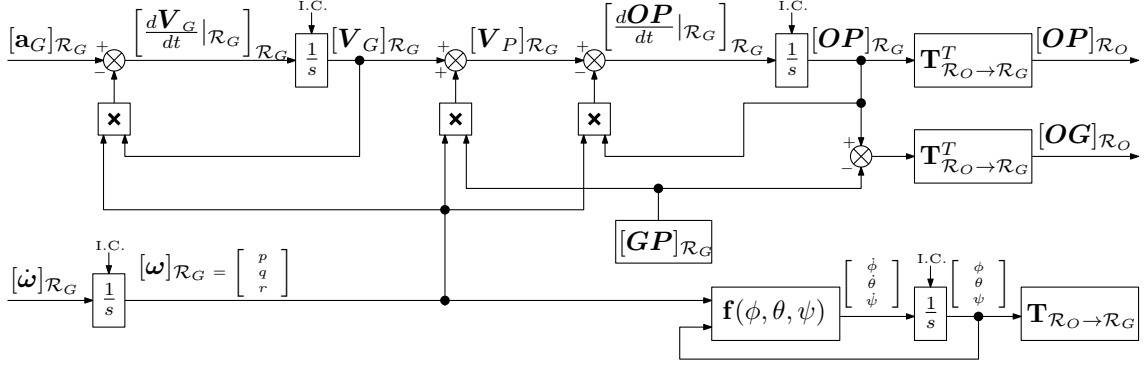

Fig. 2. Acceleration integration block

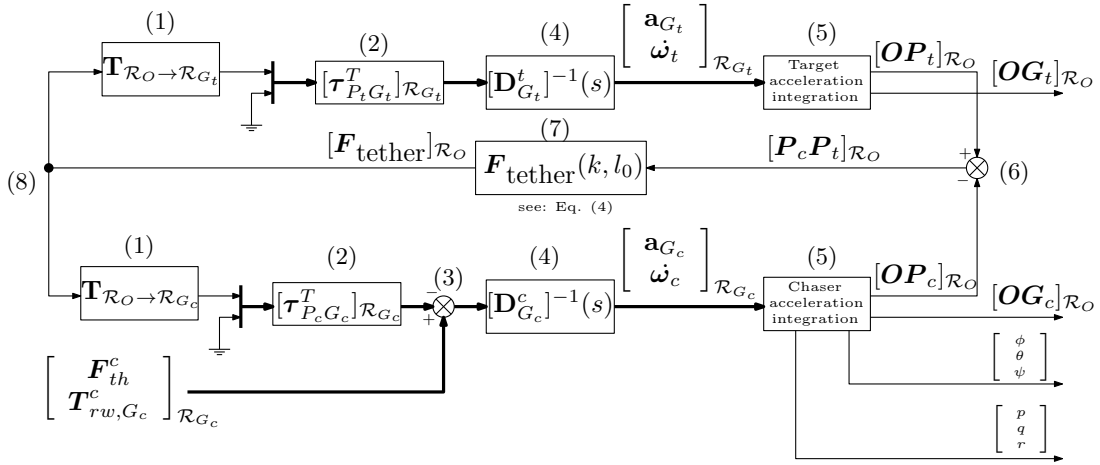

Fig. 3. Model of target and chaser satellites connected by a tether

$$\left\{ \begin{array}{l} \frac{\phi}{\phi_{ref}} = \frac{Kp_x}{s^2 + \frac{Kv_x}{I_{xx}}s + \frac{Kp_x}{I_{xx}}} \\ \frac{\theta}{\theta_{ref}} = \frac{Kp_y}{s^2 + \frac{Kv_y}{I_{yy}}s + \frac{Kp_y}{I_{yy}}} \\ \frac{\psi}{\psi_{ref}} = \frac{Kp_z}{s^2 + \frac{Kv_z}{I_{zz}}s + \frac{Kp_z}{I_{zz}}} \end{array} \right. \quad (12)$$

$$\left\{ \begin{array}{l} Kp_x = \omega_0^2 \cdot I_{xx} \\ Kp_y = \omega_0^2 \cdot I_{yy} \\ Kp_z = \omega_0^2 \cdot I_{zz} \\ Kv_x = 2 \cdot \omega_0 \cdot \xi \cdot I_{xx} \\ Kv_y = 2 \cdot \omega_0 \cdot \xi \cdot I_{yy} \\ Kv_z = 2 \cdot \omega_0 \cdot \xi \cdot I_{zz} \end{array} \right. \quad (14)$$

where I_{xx} , I_{yy} and I_{zz} are the diagonal inertia terms of the chaser at point G_c , in frame R_{G_c} .

It is desired, for all rotations, a second order response characterized by the generic parameters ω_0 and ξ :

$$\frac{\phi}{\phi_{ref}} = \frac{\theta}{\theta_{ref}} = \frac{\psi}{\psi_{ref}} = \frac{\omega_0^2}{s^2 + 2\xi\omega_0 s + \omega_0^2} \quad (13)$$

Thus, one can deduce the gains must be:

To obtain a proper response, it was used, as a first reference, $\xi = 0.7$ and $\omega_0 = 1 \text{ rad/s}$. Such a tuning is very stiff for a satellite but realistic in an active debris removal scenario. Indeed, an objective of this study is to check if the tumbling motion of the target can be damped by the transmission from the target to the chaser via the tether and by the attitude control system of the chaser (except, of course, for the rotation around the tether axis).

In the next section such a controller will be applied to the whole model.

3.2 Simulation Scenario

In the next section the simulation results will be presented. The chaser satellite has the attitude controller described previously. The references for this controller were kept at zero during the whole simulation, i.e., the chaser was servo-looped on its orbit. Also, the thrusters of the chaser were

Parameter	value (SI)
l_0	10
k	$7.85 \cdot 10^7$
m_c	100
I_{xx}	10
I_{yy}	10
I_{zz}	20
$[\mathbf{G}_c \mathbf{P}_c]_{\mathcal{R}_{G_c}}$	$[1, 0, 0]^T$
$[\mathbf{G}_t \mathbf{P}_t]_{\mathcal{R}_{G_t}}$	$[-5, 0, 0]^T$
$[\mathbf{O} \mathbf{G}_c]_{\mathcal{R}_O} (t=0)$	$[0, 0, 0]^T$
$[\mathbf{O} \mathbf{G}_t]_{\mathcal{R}_O} (t=0)$	$[10, 0, 0]^T$
$[\boldsymbol{\omega}_t]_{\mathcal{R}_O} (t=0)$	$[0, 10\pi/180, 0]^T$

Table 1. Main model data and non-null initial conditions.

turned on, as to create a negative force along the x-axis (in the chaser body frame), in order to tow the target satellite. The target satellite was set to have a tumbling motion, rotating along its y-axis. The chaser and the target were aligned along the x-axis in \mathcal{R}_O , with the target positioned in front of the chaser. The length of the cable was set to be initially unstretched. The tether will be tensioned due to the tumbling of the target and the backwards (along the x-axis in \mathcal{R}_O) motion of the chaser. However the connecting points between the tether and the satellites were set at: $[\mathbf{G}_c \mathbf{P}_c]_{\mathcal{R}_{G_c}} = [1, 0, 0]^T$ and $[\mathbf{G}_t \mathbf{P}_t]_{\mathcal{R}_{G_t}} = [-5, 0, 0]^T$.

The chaser used here was a purely rigid body of mass m_c , therefore having no flexible effects. It was also set to be an inertially symmetrical body, and thus to have null cross products of inertia. The target was set to be a spacecraft made of a rigid hub of mass 100kg with two flexible symmetric appendages, one of mass 50kg and the other 20kg. The appendages are placed geometrically symmetric with respect to the x-z plane in \mathcal{R}_{G_t} . The center of mass of the whole target shifts from that of the hub, and non-diagonal inertia moments are expected for this satellite. The data relative to the target can be found in (Alazard and Cumer, 2014) in the tutorial entitled "Example 1: Spacecraft1.m". Other data and initial conditions are summarized in Table 1.

3.3 Simulation

Figures 4, 5, 6, 8 show values in the orbital frame. Hereafter, all references to axes will be in the orbital frame (\mathcal{R}_O). All units are according to the SI. The initial conditions place the two attachment points at a distance of 4m while the unstretched tether length is 10m. This explains why in Fig. 4 there is no motion of the debris in the x-axis for the first 12 seconds (detumbling starts at around 6 seconds). The distance between the attachment points of the satellites (P_t and P_c) can be seen in Fig.7

It can be seen, in Fig. 8, the action of the tether was mostly done by "impulses", trying to tow and realign the target satellite when it goes off the desired path along the x-axis. It can also be seen, in Fig. 4 that there was a negative acceleration of the system on the x-axis as expected, meaning the towing was successful. However, it can also be seen some residual non-null position values on the y-axis and z-axis. This is due to the fact that the thrusters

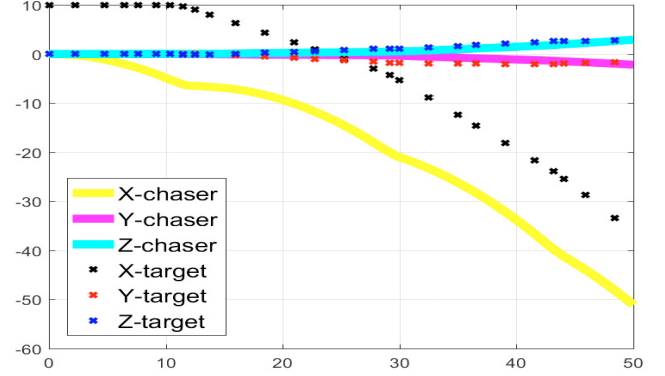

Fig. 4. Position of the two satellites in \mathcal{R}_O

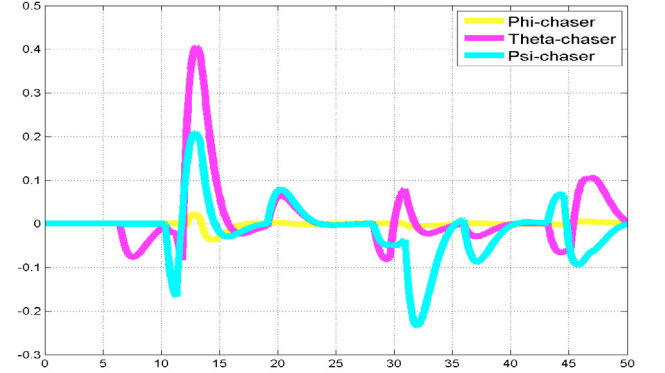

Fig. 5. Attitude of the chaser satellite in \mathcal{R}_O

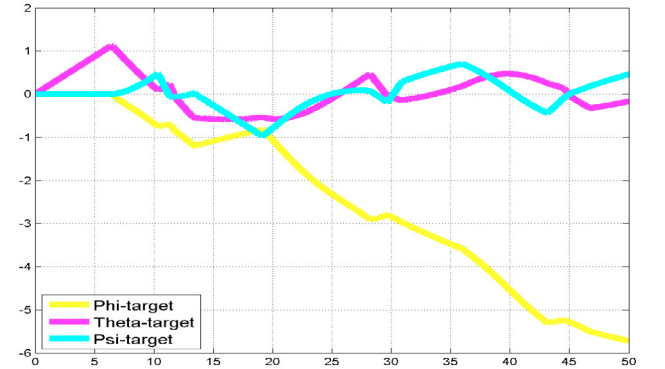

Fig. 6. Attitude of the target satellite in \mathcal{R}_O

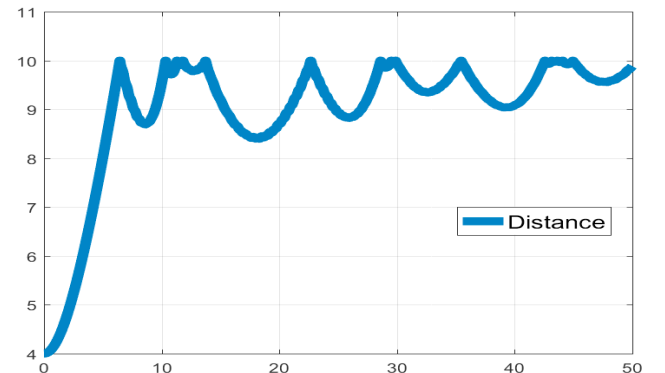

Fig. 7. Distance between the attachment points

4. CONCLUSIONS AND PERSPECTIVES

The objective of this study was to develop a modeling tool to study and design a tethered space tug during preliminary design. It models the non-linear behavior of (any) two satellites with possible flexible appendages, connected by a tether. Moreover the system is roughly controlled resorting to forces and torques applied on one of the satellites, enough to tow the other passive satellite. An important aspect of this simulator is that almost all the non-linear terms were accounted, while no simplifications were done when connecting the system. The only non-linear terms missing are due to each of the satellites models, obtained by the Satellite Dynamics Toolbox (SDT). For future perspectives, further controllers can be designed in order to, for example, maintain a constant position or a constant movement in only one axis or even to try to obtain a constant distance between the two satellites. Since here the satellites are already assumed to be exactly on the same orbit, the *Clohessy-Wiltshire* equations can be added to improve the model, as they were developed to govern *rendez-vous* maneuvers (Gladun, 2005). Sensitivity analysis could be assessed to evaluate the interaction of the tether's stiffness with the flexible modes of the satellite and to suggest recommendations on the tether's stiffness.

REFERENCES

- Alazard, D. and Cumer, C. (2014). Satellite dynamics toolbox: Principles, user guide and tutorials. URL <http://personnel.isae.fr/daniel-alazard/matlab-packages/satellite-dynamics-toolbox.html?lang=fr>.
- Alazard, D., Cumer, C., and Tantawi, K. (2008). Linear dynamic modeling of spacecraft with various flexible appendages and on-board angular momentums. In *7th International ESA Conference on Guidance, Navigation and Control Systems*. ESA, Tralee, County Kerry, Ireland.
- Ansdell, M. (2010). Active space debris removal: Needs, implications, and recommendations for today's geopolitical environment. *Journal of Public and International Affairs*.
- Aslanov, V. and Yudinsev, V. (2015). Dynamics, analytical solutions and choice of parameters for towed space debris with flexible appendages. *Advances in Space Research*, 55, 660–667.
- Das, R., Sen, S., and Dasgupta, S. (2007). Robust and fault tolerant controller for attitude control of a satellite launch vehicle. *IET Control Theory Apply*, 1(1).
- Gladun, S. (2005). *Investigation of Close Proximity Operations of an Autonomous Robotic On-Orbit Servicer Using Linearized Orbital Mechanics*. Master's thesis, University of Florida.
- Guy, N., Alazard, D., Cumer, C., and Charbonnel, C. (2014). Dynamic modeling and analysis of spacecraft with variable tilt of flexible appendages. *Journal of Dynamic Systems, Measurement, and Control*, 136(2).
- Jasper, L.E.Z., Seubert, C.R., Schaub, H., Valery, T., and Yutkin, E. (2012). Tethered tug for large low earth orbit debris removal. *AAS/AIAA Astrodynamics Specialists Conference*.
- Johnson, N. (2010). *Orbital Debris: The Growing Threat To Space Operations*.

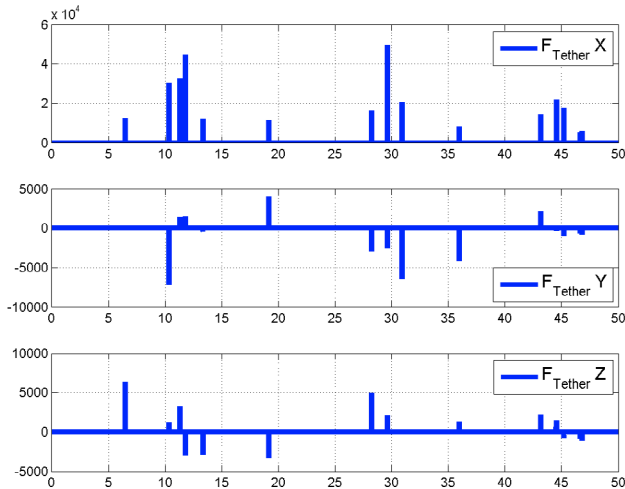

Fig. 8. Force applied by the tether in \mathcal{R}_O

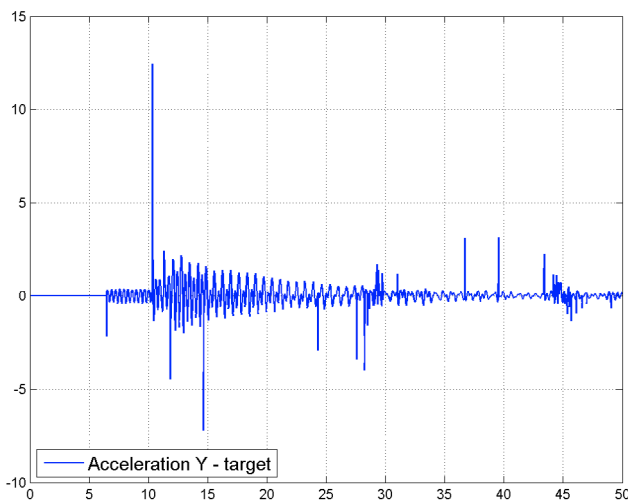

Fig. 9. Vibrations seen on the target acceleration along y-axis in \mathcal{R}_{G_t} , for $E=100$ MPa

of the chaser are aligned with its own x-axis and not the orbital frame x-axis. Therefore, during the transient response of the AOCS to counteract the disturbances due to the tether, the thrusters will create an acceleration on the orbital y-axis and z-axis. In Fig. 5 it can be seen that the AOCS stabilizes the attitude of the chaser. In Fig. 6 it can be seen that the initial tumbling around the y-axis (θ increasing linearly) is counteracted on the first stretch of the tether. It can also be observed that the attitude of the target satellite is not entirely controlled. Around the y-axis and z-axis the attitude motion is bounded, since the tether will allow the target to deviate until it is tensioned. Around the x-axis (ϕ), however, the control has no action because the tether only applies tension forces and is not modeled to apply torsion torques.

Furthermore, it can be stated that the stiffness of the tether is determinant on the amount of vibrations existent on the system. This result was previously showed in (Aslanov and Yudinsev, 2015). Tested for a modulus of Young of 100kPa, 100MPa and 100GPa, the results show much greater vibrations for the 100MPa scenario (Fig. 9).