



HAL
open science

A semi-autonomous mobile robot for bridge inspection

Baptiste Sutter, Arnaud Lelevé, Minh Tu Pham, Olivier Gouin, Nicolas Jupille, Manuel Kuhn, Pierre Lulé, Pierre Michaud, Pascal Rémy

► **To cite this version:**

Baptiste Sutter, Arnaud Lelevé, Minh Tu Pham, Olivier Gouin, Nicolas Jupille, et al.. A semi-autonomous mobile robot for bridge inspection. *Automation in Construction*, 2018, 91, pp.111-119. 10.1016/j.autcon.2018.02.013 . hal-01731226

HAL Id: hal-01731226

<https://hal.science/hal-01731226v1>

Submitted on 7 Jan 2019

HAL is a multi-disciplinary open access archive for the deposit and dissemination of scientific research documents, whether they are published or not. The documents may come from teaching and research institutions in France or abroad, or from public or private research centers.

L'archive ouverte pluridisciplinaire **HAL**, est destinée au dépôt et à la diffusion de documents scientifiques de niveau recherche, publiés ou non, émanant des établissements d'enseignement et de recherche français ou étrangers, des laboratoires publics ou privés.



ELSEVIER

Contents lists available at ScienceDirect

Automation in Construction

journal homepage: www.elsevier.com

A semi-autonomous mobile robot for bridge inspection

Baptiste Sutter^a, Arnaud Lelevé^{b, *}, Minh Tu Pham^b, Olivier Gouin^c, Nicolas Jupille^d, Manuel Kuhn^e, Pierre Lulé^a, Pierre Michaud^e, Pascal Rémy^a

^a *Structure et Réhabilitation, Saint Georges de Reneins 69830, France*

^b *Univ. Lyon, INSA, Ampère, UMR CNRS 5005, F-69621 Villeurbanne, France*

^c *MESEA, Villognon 16230, France*

^d *Mobilev-Cranes, Lentilly 69210, France*

^e *Univ. Lyon, INSA, Mechanical Engineering Dept., F-69621 Villeurbanne, France*

ARTICLE INFO

Keywords:

Mobile robotics
Bridge inspection

ABSTRACT

A semi-autonomous robotic system dedicated to road and train bridge inspection is presented in this paper. So far, bridge inspections have been performed manually by workers who either climb and rappel or use so-called mobile negative cherry pickers or specific mobile assemblies. This is a dangerous and tedious task which must be carried out during night time or when the traffic on the bridge is stopped, for safety reasons. The installation of mobile assemblies is costly, time consuming and they become not compliant with recent structures. Moreover, manual inspections require counting, measuring, locating and taking pictures of small cracks. The quality of these manual operations depends not only on the experience but also on the level of fatigue of the workers. The robotic inspection system proposed in this paper consists of three main components: a customized truck, a mobile robotic mechanism which takes pictures of the entire area of interest, and a software which automatically associates these pictures with the CAD model of the bridge.

Afterwards at office, users browse the pictures of the surfaces of the bridge with the help of the CAD software and a dedicated plugin to detect, measure and comment the bridge defects to process later. The result is summed up into a report generated by the software. The requirements and the mechanical design of this system are described and an overview of the inspections realized so far with it is provided.

1. Introduction

Bridge inspection and maintenance tasks are expensive but essential for maintaining accurate knowledge of a structure's condition so repairs or replacements can be planned for, coordinated, and carried out. This becomes increasingly significant as the number of bridges (around 266, 000 bridges are currently in France) grows more rapidly than the capacity to perform inspections. French law requires bridge owners to inspect bridge structures every 5 years, which is the most conservative inspection interval (5 to 10 years) suggested by Sommer et al. in Ref. [1].

Traditional monitoring methods use visual inspection of concrete bridges, which requires inspectors to travel to bridges and determine deterioration levels by reporting every crack on the concrete surface. Workers climb besides and under the bridges using a mobile assembly

(see Fig. 1), a nacelle at the end of a negative articulated boom mounted on a truck (a “negative nacelle”), or using ropes. Inspection workers check bridge parts by locating cracks, counting them, measuring their widths and lengths, and taking pictures of them. Classical inspection methods are further detailed and illustrated in Ref. [2].

Road bridge inspections are typically performed using negative articulated booms deployed from a truck located on the deck of the bridge. They disturb bridge traffic as they require a lane on the bridge to be closed while the inspection is conducted. According to the company *Structure & Réhabilitation*, manual road bridge inspections require from 100 to 500 pictures, taken at a rate of about 125 pictures per day, resulting in a typical displacement speed for inspection trucks of about 50 m per day. On train bridges there is not enough room between the parapet and the ballast to use the same trucks. Therefore, either an in-

* Corresponding author.

Email addresses: b.sutter@structure-rehabilitation.fr (B. Sutter); arnaud.leleve@insa-lyon.fr (A. Lelevé); olivier.gouin@mesea.fr (M.T. Pham); n.jupille@mobilev.tm.fr (N. Jupille); manuel.kuhn@insa-lyon.fr (M. Kuhn)

URL: <http://www.ampere-lyon.fr/>

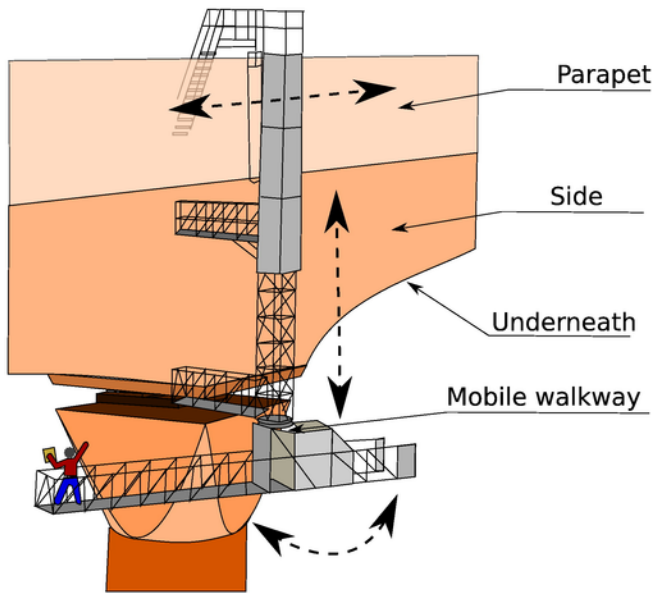

Fig. 1. Traditional train bridge mobile assembly.

spection wagon equipped with a negative nacelle is used, with the drawback that it monopolizes the railway track during inspection, or a mobile specific assembly is used, which is mounted on demand and moved along the side of the bridge (Fig. 1). Installation of assemblies costs about 16k€ and prevents train traffic during installation and removal, requiring work to be done at night in the absence of train traffic. Thus, the inspection rate of train bridges is lower than for road bridges (as low as 5 m per night).

In 2013, only 50 mobile assemblies and negative nacelles were in France, resulting in 90% of train bridges requiring inspection wagons and 70% of train bridges requiring mobile assemblies for inspection being inspected without these tools. 60% of road bridges were also inspected without negative nacelles. In these cases, inspectors rappelled or observed the underside of bridges with binoculars. A review of this situation in Europe was written by Helmerich et al. in 2008 [3]. Failure to inspect structures may lead to tragic accidents as seen in Ref. [4].

The reliability of manual inspections is a widespread problem. In Ref. [5], Phares et al. concluded that the quality of American high-speed bridge inspections vary significantly as they rely heavily on subjective assessments and human visual inspection capabilities. Moreover, the risk of human accidents is high and the work is tedious (continuously gazing upwards at night in a cold, dark, and windy environment), which may compromise the quality of the inspection. Thus, there is a need for automation of bridge inspection to maintain bridge infrastructure safety economically [3].

The semi-autonomous inspection system detailed in this manuscript was designed to inspect the sides, the underside, the girders, and the top of columns of different kinds of bridges used for train or car traffic: segmental (see Fig. 2 (a)), slab (see Fig. 2 (b)), girder (see Fig. 2 (c)), and arch (see Fig. 2 (d)).

Several major constraints were taken into account during the design process. For instance, inspections must be performed without stopping traffic, which requires the robot to move alongside the parapet and beside the roadbed. Stopping traffic is only allowed for mounting/unmounting the system on a bridge side, which should take less time than previous solutions and should be much shorter than the inspection time. The inspection system should automatically scan areas, with a manual mode to help the user take additional pictures of complex bridges. The size of train bridge gutters defined the maximum width of

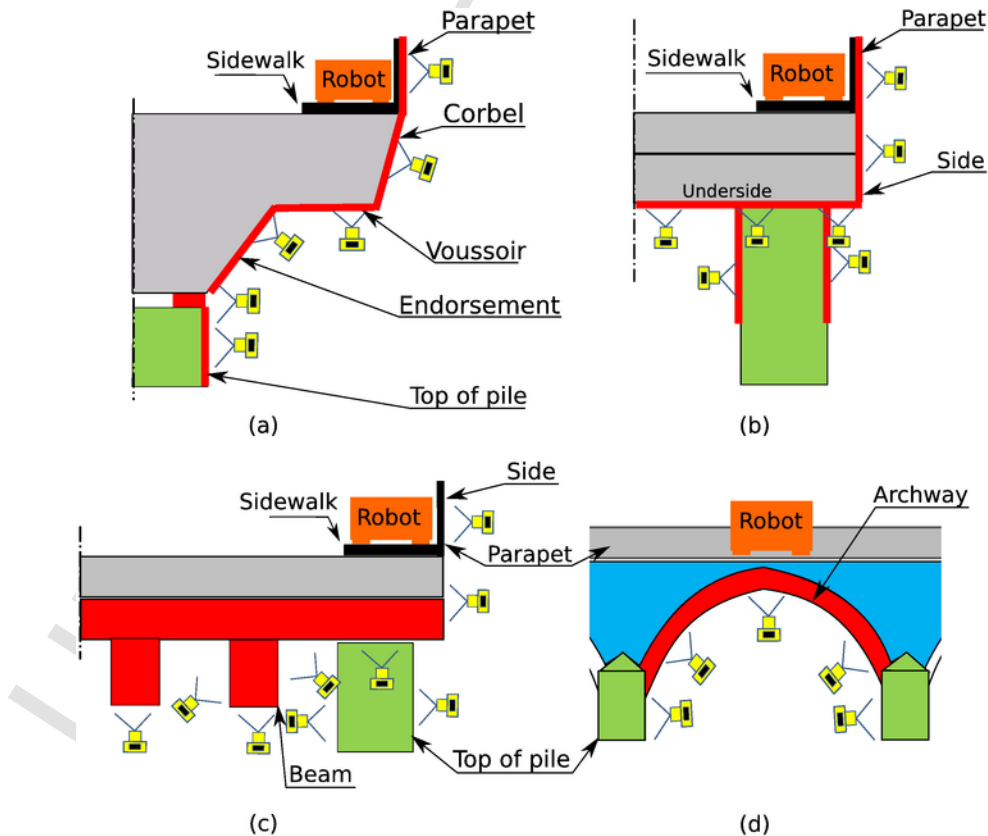

Fig. 2. Profiles of a road bridge: (a) segmental, (b) slab, (c) girder, and (d) arch. Cameras indicate areas for inspection.

the vehicle to be 70 cm. The minimum authorized distance of 3 m from catenaries required the robot height to be less than 3 m (including the arm and the cabin). A cabin to protect the operator from the travel wind of high-speed trains (which generate a pressure around 950 N/m^2 at a distance of 2 m) is mandatory.

One of the main difficulties in this project was designing a system that moves along the parapet over a gutter with a width of only 70 cm, and deploying a robotized arm capable of covering the surface of a side and half the width of the underside of the bridge (see Fig. 3). The necessity of relatively long arms and the resulting cantilever when it is deployed make this system potentially unstable (it can fall off the bridge over the parapet). Moreover, it may collide with foreign catenaries or trains during (un)deployment.

There have been a great deal of research since early 2000 (see Ref. [6], for instance, for underwater inspection of bridge piers) into robotic solutions for increasing the efficiency of bridge inspections. For instance, in Ref. [7] and later in Ref. [8] a robot was designed to inspect the deck of the bridges with nondestructive evaluation (NDE) methods: electrical resistivity, impact echo, and ground penetrating radar (GPR), which allows detection of faults under the surface and allows detecting cracks before they appear. These mobile robots preventively detect defaults under the deck surface but are heavy and only work on the deck of bridges. Other complementary solutions are necessary to inspect the underside, sides, and piles of bridges.

The teleoperated mobile robots introduced in Refs. [9] and [2] enable inspection of the wide area beneath a bridge. Regrettably, the solution proposed in Ref. [2] remains too large when folded, which restricts its displacements on conventional roads to reach bridges for inspection. The more recent solution proposed in Ref. [9] is more compact but remains too large for a train bridge. Moreover, neither solutions can inspect bridge sides and columns. A Japanese solution is briefly described in Ref. [10], which only provides information about the vision-based crack detection method. The solution introduced in this paper utilizes a similar arm architecture as proposed in the Japanese study.

Other robotic solutions have been investigated, such as in Ref. [11], where Metni et al. proposed an Unmanned Aerial Vehicle (UAV). Unfortunately, this kind of solution is not usable in our case because of safety issues with high voltage catenaries and high-speed trains. Murphy et al. also discussed Unmanned Marine Vehicles (UMV) for inspection of bridge structures under and over the water surface after disasters [12]. This solution is well suited to long bridges with piles anchored in the water, but this kind of environment is not common in France. Climbing robots such as the one introduced by Amakawa et al.

in Ref. [13] for airplane body inspection are another possibility. These robots use either magnetic forces or negative pressure suction to adhere to surfaces in general. Some applications for steel bridge inspection such as in Ref. [14] already exist, which uses an inchworm-inspired robot to inspect Australian steel bridges, and in Ref. [15], which uses a small vehicle equipped with magnetic wheels.

However, this paper focuses on bridges that are primarily constructed of concrete, which is not regular and smooth enough to ensure good adherence. Some studies have designed climbing robots for this kind of surface: Sekhar and Bhooshan introduced a duct fan based wall climbing robot in 2014 [16] for crack inspection on concrete walls. Based on Bernoulli's Principle, the duct fan creates sufficient force for the frictional force between the four wheels and the wall surface to counterbalance the weight of the robot. In 2012, Fengyu et al. introduced a similar robot based on grasping claws [17]. While these solutions work on vertical walls, they cannot walk under horizontal surfaces, limiting their utility for bridge inspection. Also, their weight is limited, making them impractical for long inspection series (the duct fan can only run for half an hour without external power), and requiring a cable to provide power and exchange information (which would be dozens of meters long and relatively heavy compared with the robot) or heavy batteries.

Tunnels present similar inspection problems as bridges and research into their robotic inspection is also in progress. For instance, a mobile robot described in Ref. [18] detects concrete cracks inside a tunnel. A 2015 survey of robotic tunnel inspection systems is given in Ref. [19]. Mobile robotic architectures are simpler than for bridges, as the robots move on the ground. Nevertheless, automatic inspection techniques are very similar to the ones used for bridges, such as the aforementioned GPR.

Concerning automatic crack detection approaches, Abdel-Qader et al. analyzed the effectiveness of four crack-detection techniques from pictures [20]. In Ref. [21], Abudayyeh et al. proposed a global software framework to efficiently manage the reporting process based on automated picture analysis. Automatic stitching of pictures, depicting bridge areas, enables inspectors to generate large pictures for further analysis [22]. These works were published before 2010 in an era when only basic crack detection methods existed, due to technologically limited acquisition systems and limited computation power. Since then, several studies have provided enhanced techniques. For instance, in 2013, Jahanshahi et al. introduced a contact-less remote-sensing crack detection and quantification methodology based on 3D scene reconstruction (computer vision), image processing, and pattern recognition. This methodology solves the problems of images of complex non-flat 3D

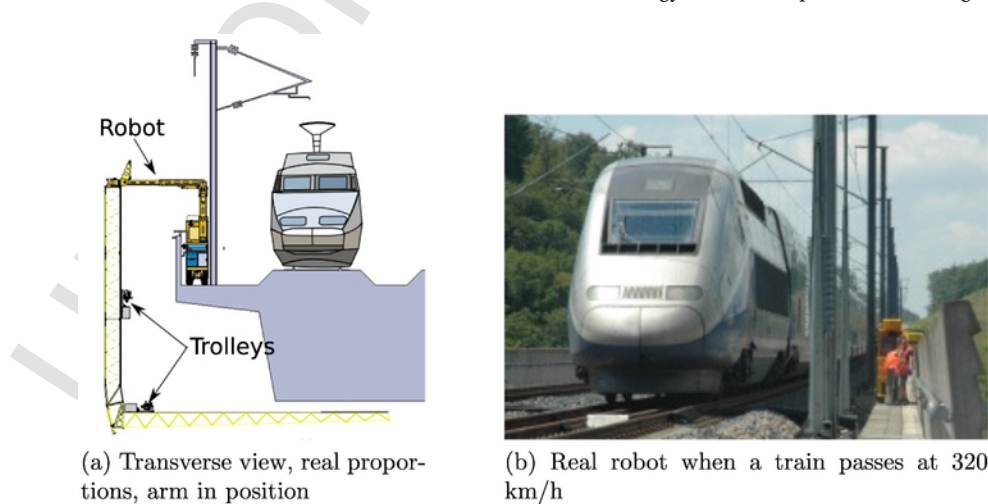

Fig. 3. Mobile robot on a high speed train bridge.

structures taken with various focal distances and resolutions [23]. Lim et al. focused on a genetic based trajectory planning mobile robot that takes crack pictures, which should enhance the autonomy of robots to perform efficient bridge surface scans [24]. In the very recent (2017) application depicted in Ref. [25], a computer vision-based method is implemented to detect surface crack on stitched images by combining several sensors (impact-echo, ultrasonic surface waves, and electrical resistivity). A review about Vision-Based Inspection of Large Concrete Structures from 2014 by Koch et al. in Ref. [26] provides more information.

This survey highlights the great deal of research that has attempted to design robots for concrete structure inspection, including automatic analysis of data and mobile robotic solutions to obtain this data. However, no available solution fits the requirements of this project's stakeholders, necessitating development of a solution for road and train bridges that can be adapted to other types of infrastructure.

This paper is organized as follows: Section 2 introduces the solution architecture. Section 3 details how inspection is automated with this robot. Finally, Section 4 validates the robot's functioning experimentally.

2. Solution architecture

Analysis of current inspection conditions led to the following objectives:

- to decrease inspection cost by 30 to 40%, compared to negative nacelles and mobile assemblies, by increasing performance and reliability;
- to increase the security of workers during bridge inspections;
- to enhance the traceability of bridges' aging by facilitating systematic monitoring of existing cracks and detection of new ones.

To achieve these objectives, the following challenges had to be overcome:

- to design a robotic arm constituting a negative boom that can reach and take pictures of hidden parts of bridges, and can be safely (un)deployed;
- to autonomously shoot photos, limiting manual operations and guaranteeing good bridge surface coverage;
- to record cracks in CAD files to facilitate their localization for further inspections and enable analysis of their evolution over time;
- to propose a manual and safe remote inspection mode from inside the cabin of the system.

The project is named INTELO, from the French “*Inspection télévisuelle d'ouvrages*” (Teleoperated Bridge Inspection). In the prototype introduced in this paper, inspections are teleoperated from the robot cabin, as stakeholders preferred the operator to stay in the robot in the initial design. Nonetheless, it is conceivable to move the inspector to a safer and more comfortable control room near the bridge in future designs. This solution features two main functional components: the arm that conveys the trolleys which take pictures under and beside the bridge, and the vehicle which holds the arm and moves along the top of the bridge on the parapet (see Fig. 3).

2.1. Robotic arm design

The primary challenge for designing the robotic arm was storing the arm above the vehicle during transportation (see Fig. 4 where the vehicle is shown with its arm raised for the sake of clarity). The arm is also required to be (un)deployed over the bridge parapet before and after photo shooting, and it should not move too close to the catenaries of train bridges.

A kinematic study accounting for the constrained workspace and the geometry of different bridges led to the following structure. As the arm is always (un)deployed at low velocity, no dynamic study was necessary. Static studies ensured the risk of rolling over the parapet due to the cantilever generated when the arm is over the parapet was limited.

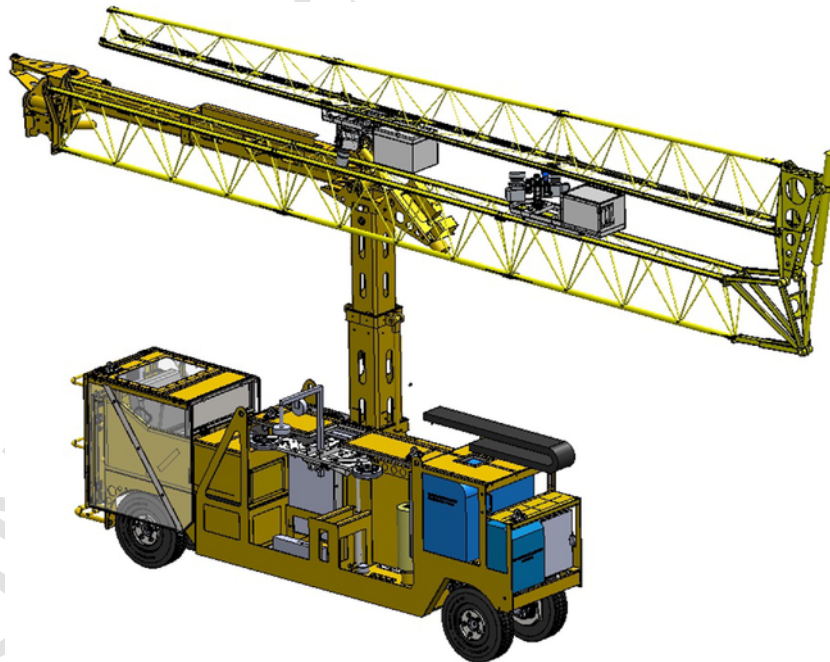

Fig. 4. Robotic arm during the transportation stages.

The deployment sequence follows (see Fig. 5):

- {1} The arm is first raised by an extendable vertical beam to reach the position of Fig. 5 (a);
- {2} The joint between the vertical beam and the first arm link is a double revolute joint which enables lateral translation of the arm in a horizontal plane (visible in Fig. 5 (a)), in order to translate it over the parapet and reach the position in Fig. 5 (b);
- {3} Then, rotation about the horizontal axis perpendicular to the vehicle allows the arm to become vertical (the arm moves in the V-plane in Fig. 5 (b) until it reaches the position of Fig. 5 (c));
- {4} The revolute joint located between the two arm links deploys the second link along the bridge in a vertical plane so that the lower arm becomes horizontal (Fig. 5 (d));
- {5} Finally, the revolute joint, located at the upper extremity of the first link, rotates the arm around the first link so that the second link comes under the bridge perpendicular to the latter longitudinal axis (corresponding to the position in Fig. 3 (a)).

The operator, located near the mobile robot and equipped with a remote, visually pilots each joint motion from the beginning of deployment, as long as the boom can be seen. Joint motions are actuated by hydraulic cylinders supplied by solenoid valves. When the boom is out of sight, the operator enters the robot cabin to continue the deployment using webcams fitted to arm sections. End of stroke sensors ensure safe machine motions. The operator is responsible for avoiding collisions with bridge parts.

The payload enforces a maximum tilting torque of the robot during stages {2}, {3} and {4}, between positions illustrated in Fig. 5 (b) and (d). This torque is minimum at positions shown in Figs. 5 (a) and 3(a). The arm is built with soldered steel lattices (see Fig. 6). This solution offers a very low wind sensitivity, a low weight and only 7 cm of flexing due to its own weight.

As bridges have various dimensions and shapes, the arm links are built up with 1 and 2m pieces that can be manually tied together to provide the arm link lengths necessary for a given inspection. This mounting is performed before each inspection based on bridge dimensions (height and width).

Two trolleys (one per arm link) proceed along the vertical (resp. horizontal) arm links to take pictures of the bridge sides (resp. of the underside), see Fig. 7. They are guided by the lattice structure and driven by a rack and pinion system (see Fig. 8). The pinion is actuated by an electric motor embedded inside the trolley. The trolley position is measured with an absolute encoder fitted to the trolley pinion. Two cameras on these trolleys are orientated by servosystems (two rotation actuators for each camera for pan and tilt orientations, and a third rotation actuator to set the zoom lens at the desired focal length) with 17bit resolution absolute encoders.

2.2. Vehicle design

2.2.1. Maneuverability

To enhance vehicle maneuverability, it is equipped with four hydraulic actuated wheels with an automatic brake for security. Two electric cylinders (one per axle) orient the wheels, so the vehicle can move sideways when all wheels are turned at the same angle.

When working on road bridges, parapets are not available to stabilize the vehicle. Supplementary lateral stabilizing wheels can be manually deployed on the vehicle sides to enlarge its contact area, as shown in Fig. 6.

2.2.2. Foldable cabin

The cabin is (un)folded manually by the operator from the rear of the vehicle. The three higher (side and front) vertical panels are made of 8mm polycarbonate glass. This material has, to our knowledge, the best compromise between weight and shock resistance. The rear face of the cabin is also a plain door through which the operator enters and leaves the cabin. The side ones are joined with the front one (the windshield). When folding, the latter rotates and the side panels move down alongside the lateral vehicle walls (see Fig. 4).

2.2.3. Parapet slider

The vehicle is stable when the arm is at rest or deployed, but it develops an important cantilever while deployed over a bridge parapet. Also, when deployed, the robot may be disturbed by a train travelling at 320km/h, as it will first be pushed towards the parapet and then drawn towards the train by the train's wind blast. Therefore, it was necessary to add a stabilization system that could filter such disturbances. A parapet sliding system stabilizes and damps lateral motions using a gas damper (see Fig. 9).

2.3. Vision system

The robot needs to take pictures at a resolution higher than 0.2mm to detect concrete cracks. These pictures are generally taken in a dark area with some gentle motions (due to the wind and arm oscillations) and from variable distances depending on the type and parts of the bridge (from a few centimeters up to 6 m). Trolleys also needed video-capable cameras for live-view mode (detailed in Section 3). These constraints led to using standard, off the shelf, digital single lens reflex (SLR) cameras with a 18–135mm lens. To take low-angle shots of the sides of the beams from the bottom without perspective distortions a second camera with a tilt-shift lens¹ was installed on the lower trolley. Because pictures have to be taken from a perpendicular position to avoid optical distortions, some vertical surfaces are not reachable by a conventional lens. Artificial lightning is provided by two diffuse and spot lights. Cameras are positioned by the robot forward kinematic model. Odometry from the wheel encoder is used for transverse coordinates. Alignment is performed on each bridge pile to compensate for cumulative measurement errors. For vertical and transversal coordinates, trolleys' encoders are used.

2.4. Automation

A Programmable Logic Controller (PLC) provides control of actuators. Every sensor and actuator communicates with the PLC through a fieldbus (an industrial Ethernet with cycle times of 276µs). They are plugged into distributed Inputs/Outputs (see Fig. 10). Hydraulic solenoid valves are connected to the hydraulic actuators (vehicle and arm motions). Axis drives are connected to the servomotors to actuate the trolleys and their cameras. A second Ethernet network is used to communicate between the PLC and the HMI (Human-Machine Interface) computer, between the latter and the trolleys' cameras to turn them off and fetch pictures, and between webcams for environmental view. The vehicle propulsion is controlled by an analog signal supplying a PWM converter, which sends pulses to a hydraulic solenoid valve. An optic encoder located on a wheel measures the displacement of the vehicle. Steering is performed by electric servomotors, as we did not want to

¹ "Tilt-shift" lenses control the rotation of the lens plane relative to the image plane (tilt), and the shift of the lens parallel to the image plane. Such lenses are frequently used in architectural photography to control image perspective.

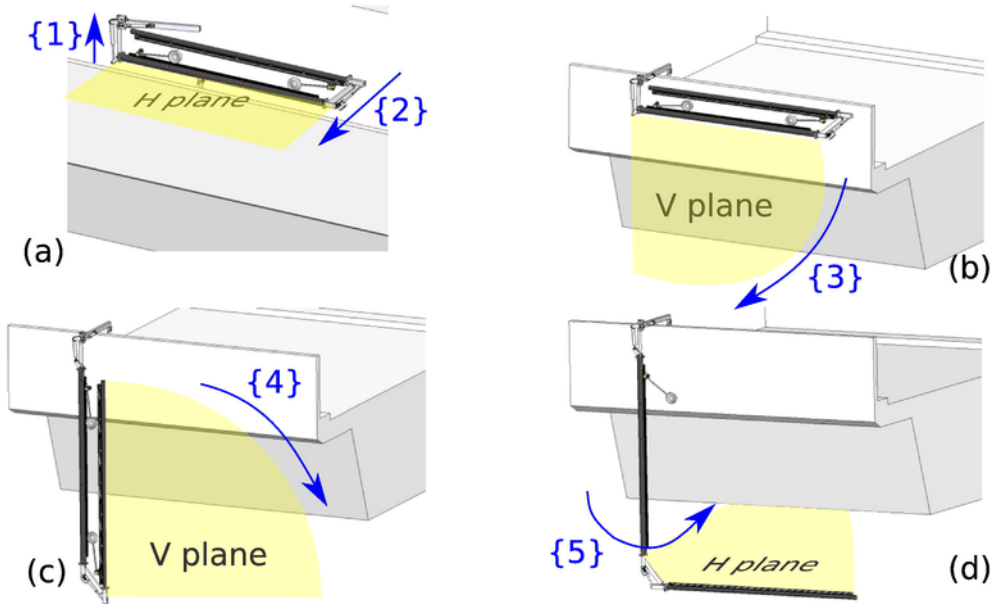

Fig. 5. Primary steps of arm deployment.



Fig. 6. Mobile robot in approach stage for a road bridge inspection. The cabin and the arm are folded. The lateral stabilizing wheels are deployed.

lose hydraulic power for the propulsion subsystem each time the wheels turn.

In automatic mode, two laser range finders measure the distance between the front and the rear of the vehicle from the parapet to ensure it is followed precisely (i.e. maintain a constant distance and stay parallel to the parapet). A PID control algorithm runs in the PLC to control the trajectory with these objectives.

2.5. Software

2.5.1. On-board Human Machine Interface

The Human Machine Interface (HMI) software had the following requirements:

- display of live video streams from webcams and cameras;
- display of pictures taken by the cameras;
- display of the position of trolleys, and the orientation of the cameras in their environment;
- management of the robot states (manual, automatic, emergency, ...);
- tagging of the pictures with metadata to help in their indexing and geo-tracking.

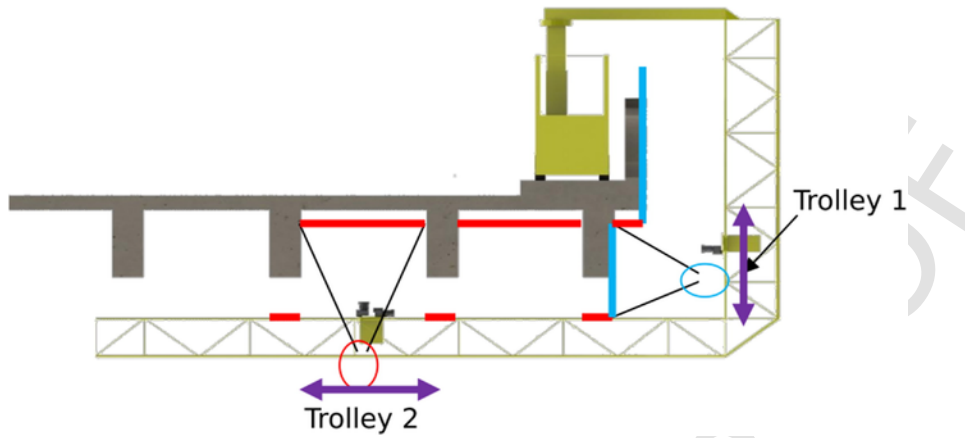

Fig. 7. The trolleys on each arm section.

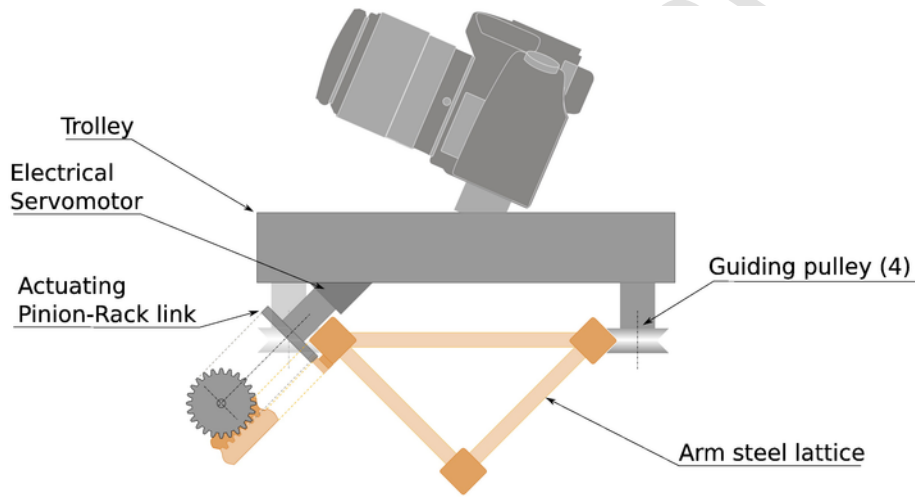

Fig. 8. Mechanical link between each trolley and the lattice structures, transversal cross section.



Fig. 9. Parapet slider installed on a parapet.

Dedicated software was developed to fulfill these requirements, making use of the library Aforge.NET v2.2.5² to obtain video streams from webcams over the on-board Ethernet network. It uses the PLC network Application Programming Interface (API) to communicate

through Ethernet with the PLC. The SLR camera Software Development Kit (SDK) is used to control cameras remotely and to fetch live view images and pictures. The EXIF library is used to tag pictures with metadata for indexing and geo-tracking.

2.5.2. Office software

After each inspection, pictures are transmitted to the office where they are used to generate an inspection report. Users perform a visual check of the surfaces of the bridge on each high resolution picture

² Available from <http://www.aforgenet.com>.

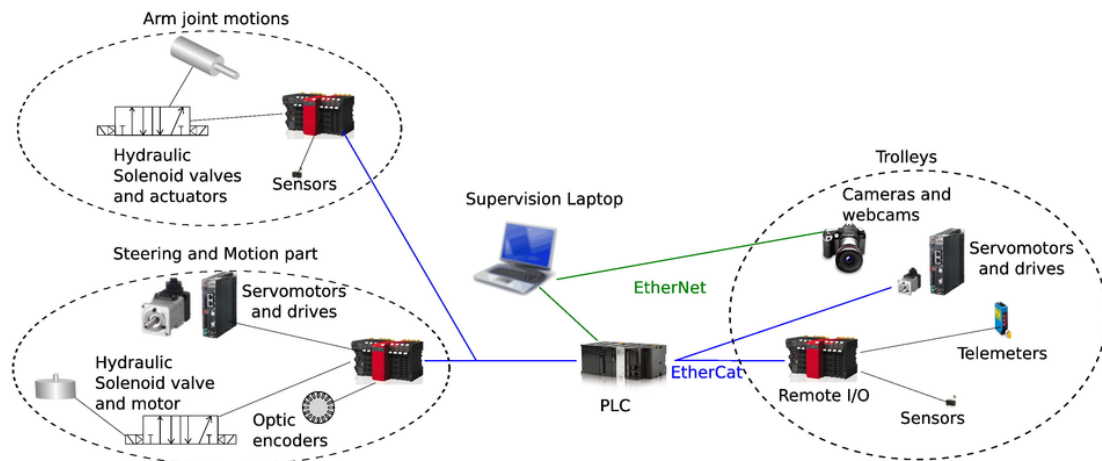

Fig. 10. Robotic system architecture including trolley, arm joints and vehicle motion control parts.

mapped on the bridge sketch, using Autodesk™ AutoCAD software. This software displays the location of every picture. When a crack is found, users click on it. A dedicated AutoCAD plug-in³ automatically detects its contours and determines its dimensions. In practice, inspectors do not use the display of the pictures inside AutoCAD 3D view due to high CPU usage. They only use it to link the 3D model of the bridges with the pictures. The user only inputs additional crack meta-data (seriousness, for instance, in addition to length and width). At the end of the process, the plug-in automatically generates a detailed report of the inspection with the defects for later processing. This reporting approach is much easier for inspectors than previous approaches. The use of recently developed algorithms found in the literature and detailed in the introduction might further facilitate and accelerate analysis and reporting.

3. Inspection automation

This section presents how inspections are automated in practice.

3.1. Inspection modes

Three operating modes are provided to the inspector:

- a live-view mode which sends video images for the inspector to take pictures as desired;
- a full automatic mode where the mobile robot simultaneously inspects a side and half of the underside. To correctly position the cameras for the pictures, a first transversal run records and displays the geometry of the surfaces on the inspector HMI (see Section 2.5.1) using a laser range finder located beside the cameras on each trolley (its red spot can be seen in Fig. 11). This geometry may differ slightly from the geometry indicated in bridge CAD files. The inspector can then manually rectify the positions and angles of the shooting locations for the following automatic steps. Then, the next transversal runs take overlapping pictures. When a slice is finished, the vehicle moves forward parallel with the parapet to scan the next slice with an overlapping area. Between each picture, the robot switches into live-view mode so the inspector can follow the process in real-time;
- a step-by-step mode where the robot positions itself and then allows the inspector to take pictures. Between two pictures, the robot switches into live-view mode.

In full automatic mode, the first transversal run compensates for transversal positioning errors due to the very long kinematic chain and effect of gravity on the structure. Accumulated longitudinal position errors are limited as the arm is partly stored to pass each pile. The longitudinal position is then manually reset according to the previous pile longitudinal position.

3.2. Image placement process

Each picture of a part of a bridge is integrated into a 2D CAD drawing. Each picture is eventually rotated and distorted based on the relative positions of the camera and the target. A projection process is then performed to compute the position of the resulting picture in the frame of the 2D CAD drawing. To do this, the position of the sensitive frame of the camera is computed based on the bridge frame. Knowing the SLR optical properties and the distance from the camera to the photographed bridge part, the coordinates of each picture are computed in the frame of the 2D drawing. This information is then recorded in the EXIF meta-data of the image file.

The process is as follows:

1. during capture, the following 3D localization information is stored in the image: orientation and position of the camera, focal distance, dimension of the camera sensor, distance to the target, and normal vector of the target;
2. after capture, this information is used to compute the position of the corners of the picture;
3. the picture is then rotated to put it into the 2D CAD drawing showing the surface shot by the camera.

4. Experimental robotic system validation

The mobile robot has been tested successfully for 30 days on different types of bridge: over a road, over a channel, on top of a dam, and a train bridge. Different profiles have been tested, including segmental, slab, girder, and arch⁴. The robot can deploy its arm over a 2.5m high parapet. The vertical and horizontal arm sections can measure up to 7m each. The robot can be used with a slope of 15°, moving at maximum velocity of 5km/h and completing 12h of inspection using 1.2l of petrol per hour. The engine is only used to drive the hydraulic pump and the electrical generator. It is able to work with wind speeds below

³ Designed by WIIP® company.

⁴ See movie on <https://youtube/uRGKeT6xyM>.

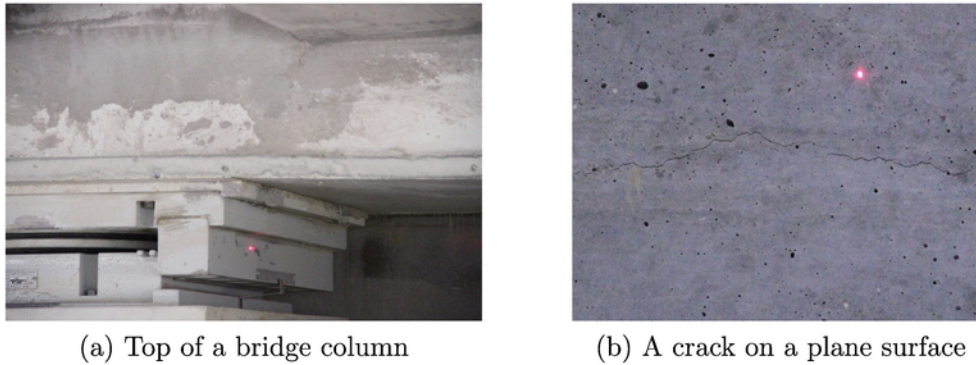

Fig. 11. Samples of pictures taken by INTELO on a train bridge in Angoulême. Both show the red laser range finder. (For interpretation of the references to color in this figure legend, the reader is referred to the web version of this article.)

3 m/s during inspection and 2 m/s during (un)deployment. Each trolley can take up to one picture per second in automatic mode, which permits between 80 and 500 high resolution (20 Mpixels) images per bridge during an inspection. See Fig. 11 for two samples of pictures of the top of a bridge column and a crack on a plane surface. The large area covered (each one covering 1 m²) and the high resolution of pictures do not require them to be stitched as in Ref. [22] (it is counterproductive with today's computers and graphic adapters). In practice, inspectors prefer using the live view mode during on-site inspection, which allows them to detect any defect in real-time and potentially take additional pictures. This results in 100 to 150 images per inspection day, which is about the same rate as with classical inspections, but with only one inspector seated in a safer and more comfortable position.

It is too early to determine whether the cost reduction objective is achieved. Further intensive use will help determine this. The robot will be used for bridge inspection of the *Sud-Europe-Atlantique* High Speed Train line.

5. Conclusions

Bridge inspection and maintenance require new robotic tools to enhance performance and inspector security. A literature review found that several strategies have been studied for many years. Yet, no solution efficiently fit the requirements for inspections of most French bridges and, more particularly, of recently built train bridges. Indeed, the INTELO project stakeholders required an evolutionary mobile robot that can inspect a wide variety of bridge architectures with a very low impact on bridge traffic, in contrast with existing solutions. Inspection is achieved by taking pictures that are used post-inspection for automatic detection and measurement of the evolution of concrete cracks visible on many bridge surfaces. This manuscript describes the requirements to accomplish these tasks and introduces an architecture to scan the sides and underside of a wide range of train and road bridges.

More than 30 days of use ensured the robot's safety and validated that it can provide more useful digital information of inspected bridges than tedious and dangerous manual inspections. The robot is authorized to work on High Speed Railways next to trains operating at 320 km/h without any impact on commercial traffic. A decade ago, drones began being used to ease inspections of power dams, nuclear plants and water channels: they are now widespread. We hope that use of such a robot for bridge inspection will grow in a similar fashion.

In the future, new NDE sensors (such as ground penetrating radars, acoustic sensors, electrical resistivity sensors) could be added to enrich inspections by automatically detecting internal defects. Furthermore, it is conceivable to move the inspector off the bridge to a safer and more comfortable control room near the bridge for teleoperation of the ro-

bot. Regular use of the robot for inspections will help enhance its design and determine new requirements.

Acknowledgments

We thank Région Rhone Alpes and European Community for their financial support. We also thank every partner:

- Structure et Réhabilitation® company, the main stakeholder, for leading this project.
- Mobilev® company which built the vehicle, assembled the prototype, and now markets it;
- MESEA® company which is the final customer for the inspections of the train bridges of the High Speed Railway Line *Sud-Europe-Atlantique* (inaugurated in March 2017). MESEA was also in charge of the rail safety conformance of the design and obtained the necessary authorizations for use of the robot besides railways;
- The Mechanical Engineering Department of INSA Lyon which designed the robotic arm.

In memory of our friend and colleague **Pascal Rémy**.

References

- [1] A.M. Sommer, A.S. Nowak, P. Thoft-Christensen, Probability-based bridge inspection strategy, *J. Struct. Eng.* 119 (12) (1993) 3520–3536.
- [2] P.-C. Tung, Y.-R. Hwang, M.-C. Wu, The development of a mobile manipulator imaging system for bridge crack inspection, *Autom. Constr.* 11 (6) (2002) 717–729.
- [3] R. Helmerich, E. Niederleithinger, D. Algernon, D. Streicher, H. Wiggenhauser, Bridge inspection and condition assessment in Europe, *Transp. Res. Rec. J. Transp. Res. Board* 2044 (2008) 31–38.
- [4] Wikipedia, List of Bridge Failures, May 2017 https://en.wikipedia.org/wiki/List_of_bridge_failures, (accessed: 2017-05-01).
- [5] B.M. Phares, G.A. Washer, D.D. Rolander, B.A. Graybeal, M. Moore, Routine highway bridge inspection condition documentation accuracy and reliability, *J. Bridge Eng.* 9 (4) (2004) 403–413.
- [6] J. DeVault, Robotic system for underwater inspection of bridge piers, *IEEE Instrum. Meas. Mag.* 3 (3) (Sep 2000) 32–37.
- [7] H.M. La, N. Gucunski, S.-H. Kee, L.V. Nguyen, Data analysis and visualization for the bridge deck inspection and evaluation robotic system, *Vis. Eng.* 3 (1) (2015) 1–16.
- [8] P. Prasanna, K.J. Dana, N. Gucunski, B.B. Basily, H.M. La, R.S. Lim, H. Parvardeh, Automated crack detection on concrete bridges, *IEEE Trans. Autom. Sci. Eng.* 13 (2) (April 2016) 591–599.
- [9] J.-K. Oh, G. Jang, S. Oh, J.H. Lee, B.-J. Yi, Y.S. Moon, J.S. Lee, Y. Choi, Bridge inspection robot system with machine vision, *Autom. Constr.* 18 (7) (2009) 929–941.
- [10] J.H. Lee, J.M. Lee, H.J. Kim, Y.S. Moon, Machine Vision System for Automatic Inspection of Bridges, In: 2008 Congress on Image and Signal Processing, vol. 3, May 2008, pp. 363–366.
- [11] N. Metni, T. Hamel, A UAV for bridge inspection: visual servoing control law with orientation limits, *Autom. Constr.* 17 (1) (2007) 3–10.

- [12] R.R. Murphy, E. Steimle, M. Hall, M. Lindemuth, D. Trejo, S. Hurlbaeus, Z. Medina-Cetina, D. Slocum, Robot-assisted bridge inspection, *J. Intell. Robot. Syst.* 64 (1) (2011) 77–95.
- [13] T. Amakawa, T. Yamaguchi, Y. Yamada, T. Nakamura, Development of an adhesion unit for a traveling-wave-type, omnidirectional wall-climbing robot in airplane body inspection, In: 2017 IEEE International Conference on Advanced Intelligent Mechatronics (AIM), July 2017, pp. 291–296.
- [14] P. Ward, P. Quin, D. Pagano, C. Yang, D. Liu, K. Waldron, D. Dissanayake, G. Paul, P. Brooks, P. Mann, W. Kaluarachchi, P. Manamperi, L. Matkovic, Climbing Robot for Steel Bridge Inspection: Design Challenges, In: Proc. of the 9th Austroads Bridge Conference, ARRB Group, New South Wales, Australia, 2014.
- [15] N.H. Pham, H.M. La, Q.P. Ha, S.N. Dang, A.H. Vo, Q.H. Dinh, Visual and 3D Mapping for Steel Bridge Inspection Using a Climbing Robot, In: Proc. of the 33rd International Symposium on Automation and Robotics in Construction (ISARC 2016), July 2016, pp. 141–149, <https://doi.org/10.22260/ISARC2016/0018>, (Auburn, AL, USA).
- [16] P. Sekhar, R.S. Bhooshan, Duct fan based wall climbing robot for concrete surface crack inspection, In: 2014 Annual IEEE India Conference (INDICON), Dec 2014, pp. 1–6.
- [17] X., W. Xingsong, L. Xiuping, Modeling method for wall-climbing robot based on grasping claws, In: 2012 IEEE International Conference on Mechatronics and Automation, Aug 2012, pp. 1663–1668.
- [18] S.-N. Yu, J.-H. Jang, C.-S. Han, Auto inspection system using a mobile robot for detecting concrete cracks in a tunnel, *Autom. Constr.* 16 (3) (2007) 255–261.
- [19] R. Montero, J. Victores, S. Martinez, A. Jardon, C. Balaguer, Past, present and future of robotic tunnel inspection, *Autom. Constr.* 59 (2015) 99–112.
- [20] I. Abdel-Qader, O. Abudayyeh, M.E. Kelly, Analysis of edge-detection techniques for crack identification in bridges, *J. Comput. Civil Eng.* 17 (4) (2003) 255–263.
- [21] O. Abudayyeh, M.A. Bataineh, I. Abdel-Qader, An imaging data model for concrete bridge inspection, *Adv. Eng. Softw.* 35 (8-9) (2004) 473–480.
- [22] Z. Zhu, S. German, I. Brilakis, Detection of large-scale concrete columns for automated bridge inspection, *Autom. Constr.* 19 (8) (2010) 1047–1055.
- [23] M.R. Jahanshahi, S.F. Masri, C.W. Padgett, G.S. Sukhatme, An innovative methodology for detection and quantification of cracks through incorporation of depth perception, *Mach. Vis. Appl.* 24 (2) (Feb 2013) 227–241.
- [24] R.S. Lim, H.M. La, W. Sheng, A robotic crack inspection and mapping system for bridge deck maintenance, *IEEE Trans. Autom. Sci. Eng.* 11 (2) (April 2014) 367–378.
- [25] H.M. La, N. Gucunski, K. Dana, S.-H. Kee, Development of an autonomous bridge deck inspection robotic system, *J. Field Robot.* (2017), n/a–n/a.
- [26] C. Koch, S.G. Paal, A. Rashidi, Z. Zhu, M. König, I. Brilakis, Achievements and challenges in machine vision-based inspection of large concrete structures, *Adv. Struct. Eng.* 17 (3) (2014) 303–318.