



HAL
open science

Motion on a Necker cube leads to micro-pursuit-like eye movements and affects the dynamics of bistability

Kevin Parisot, Alan Chauvin, Anne Guérin-Dugué, Ronald Phlypo, Steeve Zozor

► To cite this version:

Kevin Parisot, Alan Chauvin, Anne Guérin-Dugué, Ronald Phlypo, Steeve Zozor. Motion on a Necker cube leads to micro-pursuit-like eye movements and affects the dynamics of bistability. ECM 2017 - 19th European Conference on Eye Movements, Aug 2017, Wuppertal, Germany. pp.869 - 878. hal-01726513

HAL Id: hal-01726513

<https://hal.science/hal-01726513v1>

Submitted on 5 Sep 2018

HAL is a multi-disciplinary open access archive for the deposit and dissemination of scientific research documents, whether they are published or not. The documents may come from teaching and research institutions in France or abroad, or from public or private research centers.

L'archive ouverte pluridisciplinaire **HAL**, est destinée au dépôt et à la diffusion de documents scientifiques de niveau recherche, publiés ou non, émanant des établissements d'enseignement et de recherche français ou étrangers, des laboratoires publics ou privés.



Objectives

Theory: models of perceptual bistability (Moreno-Bote et al., 2011 & Shpiro et al., 2009) are governed by two forces: *adaptation* & *noise*.

Experiment goal: manipulate perceptual dynamics using retinal image motion.

Method: Unpredictable motion → add noise & predictable motion → mitigate neural adaptation

Study the effects of adaptation and noise on perceptual reversal speed:

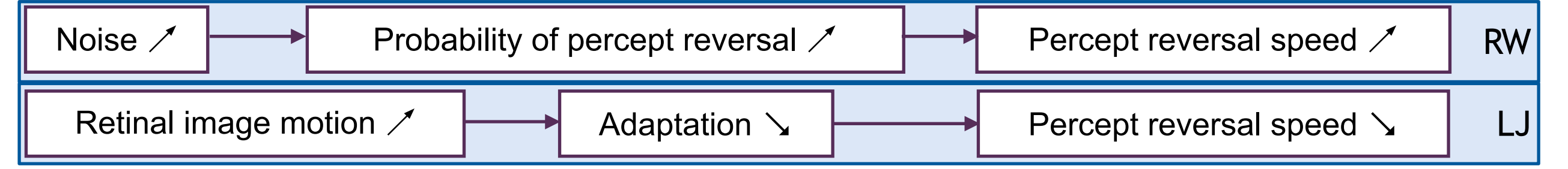

Theoretical models of bistable perception

Bistable perception: oscillation between different perceptual states under constant physical stimulus.
Models: Constant stimulation → neural adaptation → periodic suppression of alternative percept energy → **adaptation** drives the choice of percept.

Hypothesis: Predictable retinal image motion

- ↪ counteract adaptation effect
- ↪ observe lower reversal speed (cf. binocular rivalry results from Blake, Sobel & Gilroy, 2003).

Models: Visual processing noise → **noise** triggers percept reversal.

Hypothesis: Unpredictable retinal image motion

- ↪ variance of visual information input
- ↪ increase system noise
- ↪ observe higher reversal speed.

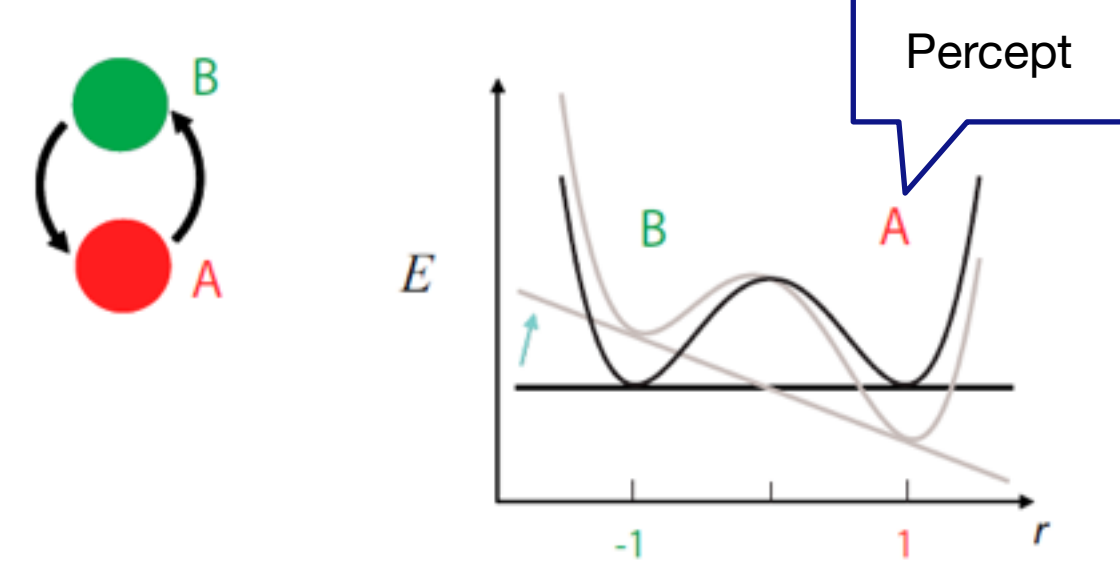

Moreno-Bote, Knill & Pouget, 2011
 Figure 1: Schematic diagram of bistable energy potential.

Experimental protocol

Task: stare at fixation cross (screen center) during a sequence of stimulus presentation (*Necker cube* - Fig. 2a) & report perceptual changes with keypress.

Participants: n = 26 (16 females and 10 males, M(age) = 28.35, SD(age) = 10.93, range = 20-71).

16 participants were analyzed after outliers & incoherent data removal.

Conditions:

FX: no stimulus motion (**Fixed**).

RW: pseudo-random movements (**Random Walk**)

LJ: smooth **Lissajou** trajectory

→ Global sequence motion was matched between RW & LJ → 36 deg/sec

Experimental design: 3 blocks of 15 sequences (pseudo-random shuffle) of 5-9 reversals.

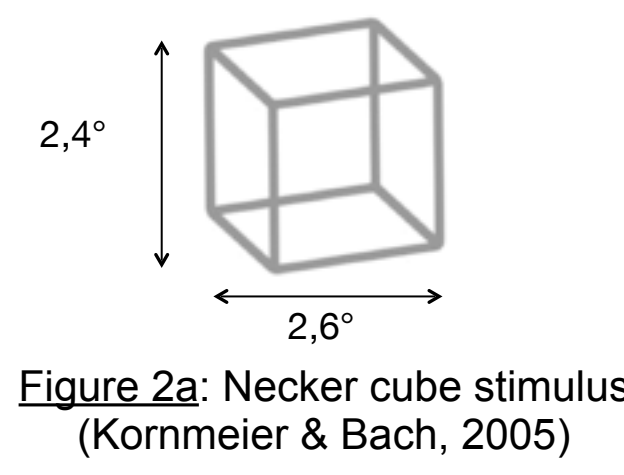

Figure 2a: Necker cube stimulus (Kornmeier & Bach, 2005)

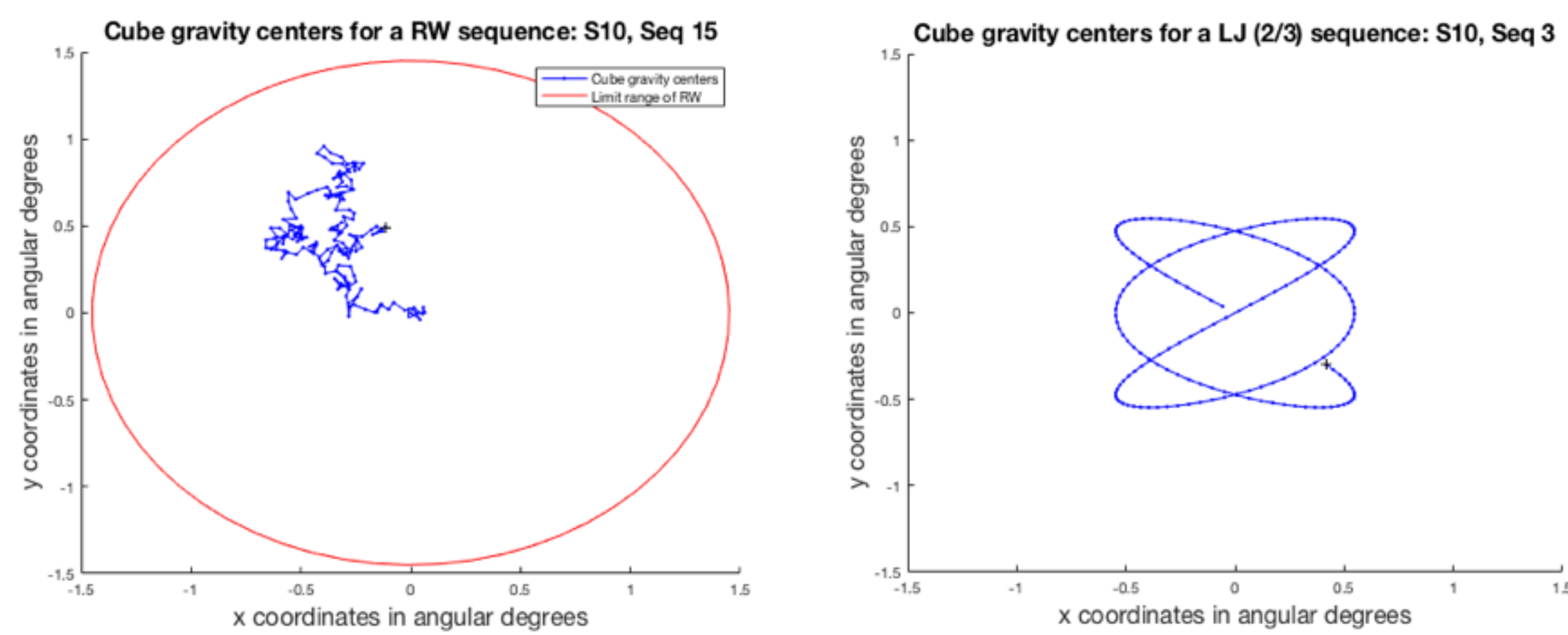

Figure 2b: (left) Stimulus centre of gravity motion in RW. (right) Stimulus centre of gravity motion in LJ.

Apparatus:
 Display: 30 by 40 cm (20") VisionMaster Pro 513 at 57 cm from participants.
 Resolution & refresh rate: 1024 by 768 pixels & 75 Hz.
 Eye-tracker: EyeLink 1000 binocular recording at 1000 Hz.

Behavioral analysis

Percept reversal speeds (RS) calculated from measured phase times. As in Blake et al., (2003) RS [rev/min] was computed:

$$RS_{seq} = \frac{n_{seq} * 60}{T_{seq}} \quad \begin{matrix} n_{seq}: \text{number of reversals} \\ T_{seq}: \text{sequence total time} \end{matrix}$$

Results:

- RW will increase RS → **not strong enough**
- LJ will decrease RS → **opposite**
- LJ results differ from binocular rivalry (Blake; Sobel & Gelay, 2003)

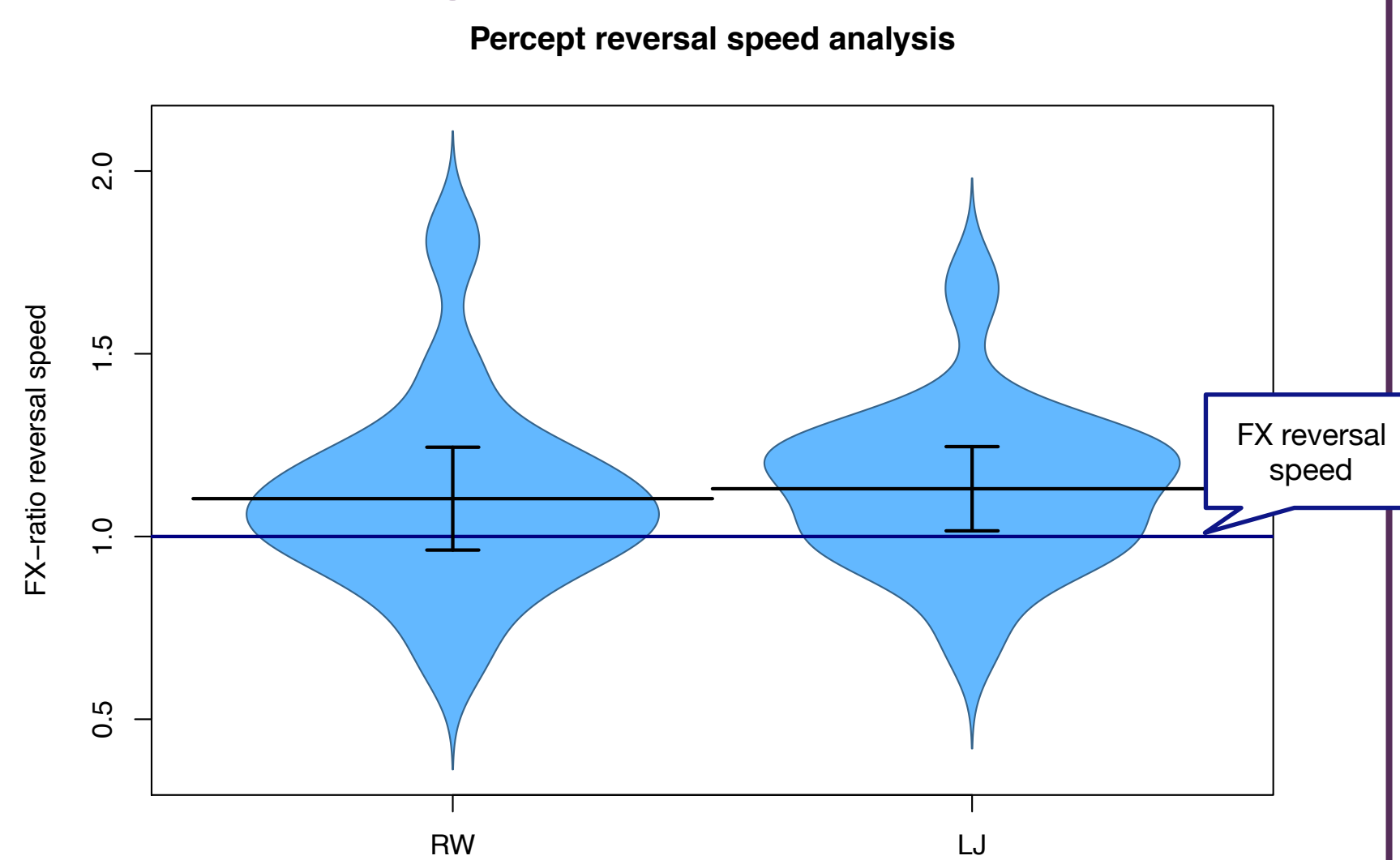

Figure 3: Violin plot of FX-ratio percept reversal speed with means and 95% confidence intervals.

Eye-tracking analysis

Adaptation mitigation based on predictable motion of retinal image → excite new populations of neurons.

⚠ Warning: depends on participants' gaze stability on fixation cross.

Measures:

M1. Inertia:

$$I_s = \frac{1}{N_s} \sum_{i=1}^{N_s} (\bar{x}_i^2 + \bar{y}_i^2)$$

N_s : number of signal s samples
 (\bar{x}_i, \bar{y}_i) : spatial coordinates of signal s adjusted to different referential (e.g. center of screen, center of fixation, stimulus position, etc)

M2. Mutual information: $I(X;Y) = H(Y) - H(Y|X)$

with $H(Y)$ the marginal entropy and $H(Y|X)$ the conditional entropy under the assumptions of normal joint distributions and independence.

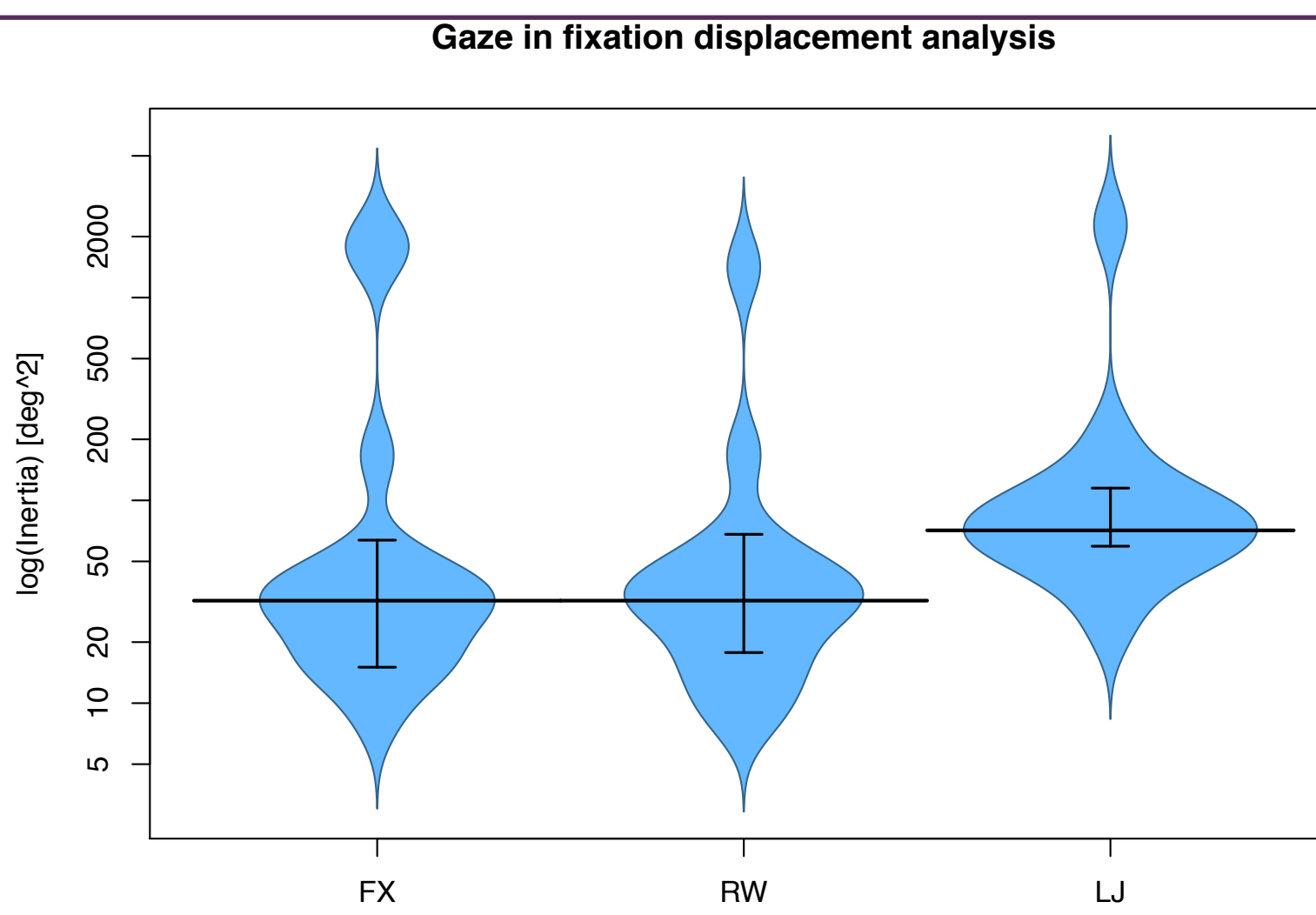

Fixational eye movements (FEM) displacement, mean sequence inertia (see M1) w.r.t. fixation event position (see Fig. 4a):
 FX ≈ RW
 (FX & RW) < LJ

→ LJ condition generates more FEM displacement than FX & RW.

← Figure 4a: Statistics of inertia (log-scale) of gaze samples against fixation positions.

Micro-smooth pursuits? Gaze during LJ seemed to follow cube trajectory (see Fig. 4b).

Similarity between gaze in fixations & cube trajectory computed with *mutual information* (see M2 & Fig. 4c): LJ ≠ RW

Eyetracking signals over a fixation: S10, Seq 3 (LJ), Fix 9

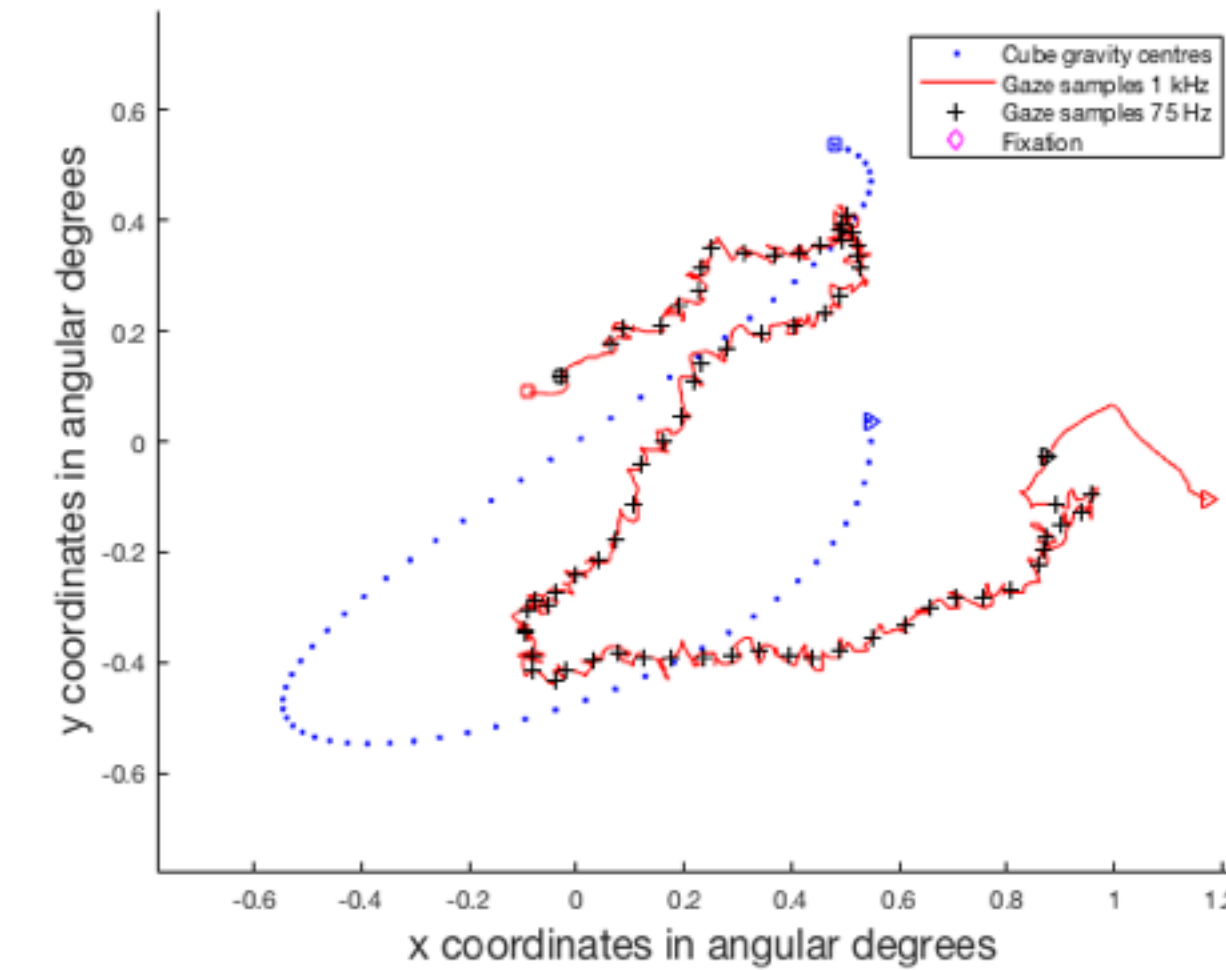

Figure 4b: Example of spatial trajectories over a fixation in ocular data.

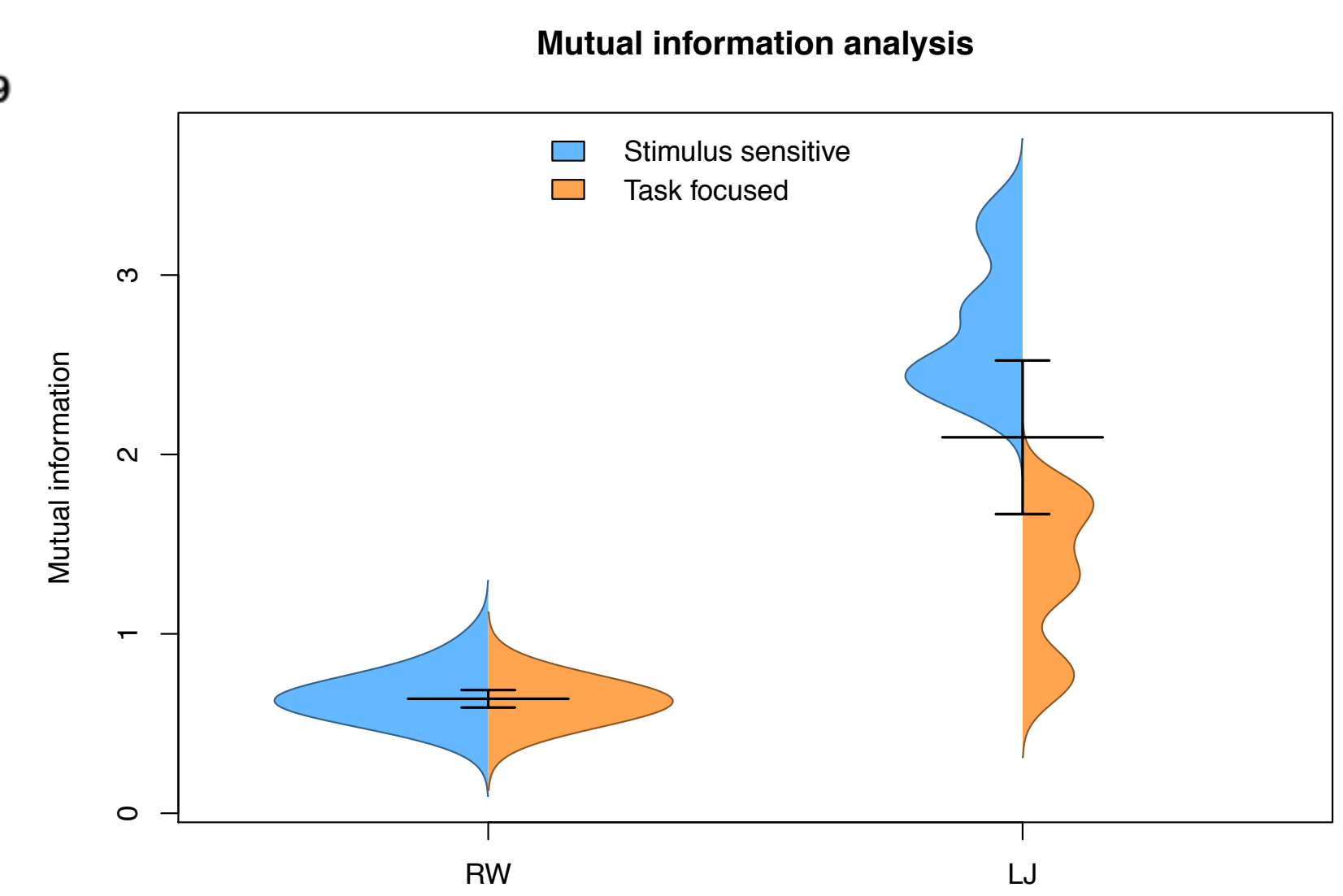
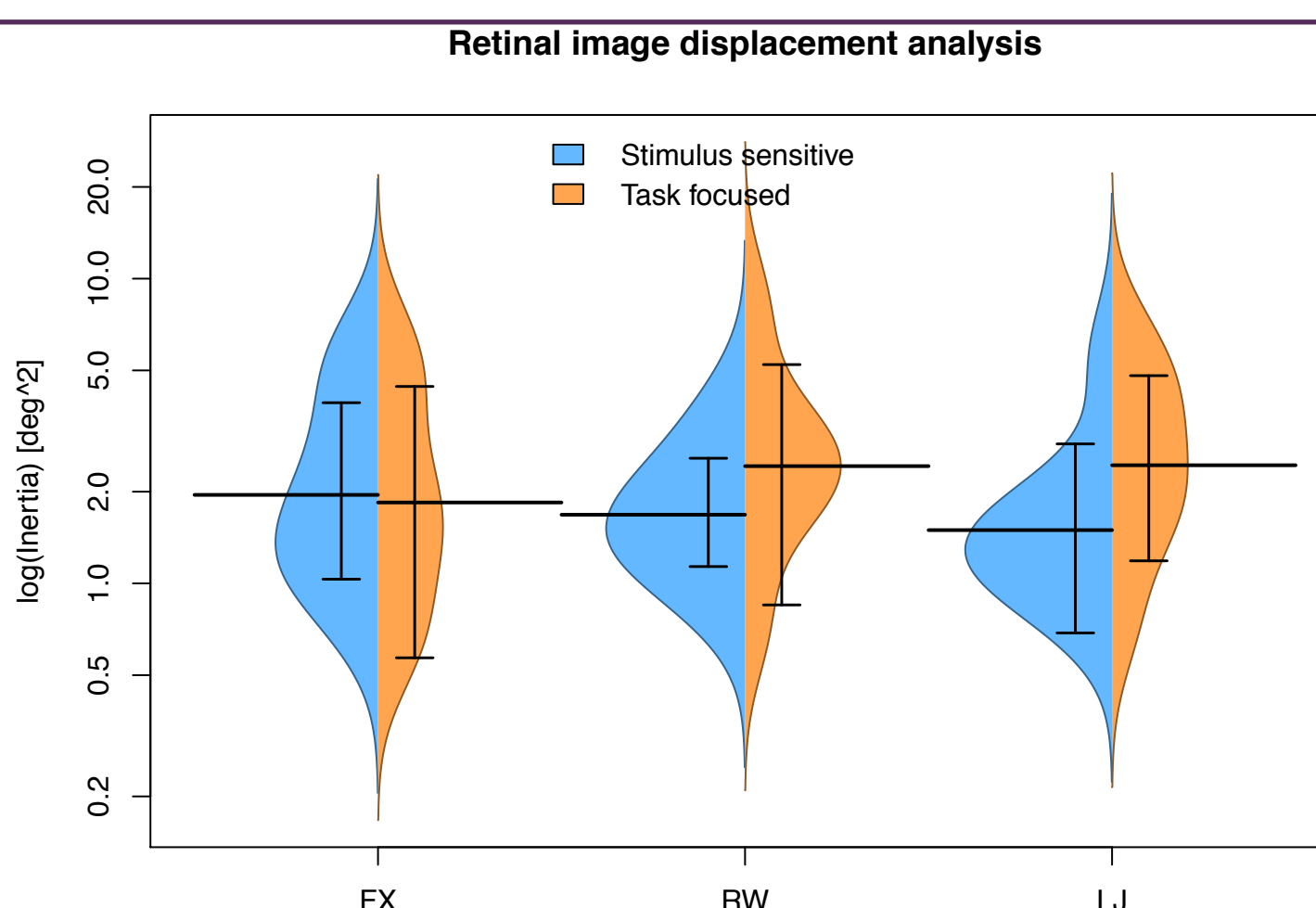

Figure 4c: Statistics of mutual information. Black bars indicate mean and 95% confidence interval for the 16 participants. Color indicates the distribution of MI for each group - **stimulus sensitive** (n=9) & **task focused** (n=7) - based on their MI in LJ.



Retinal image displacement, mean fixation inertia (see M1) w.r.t. gaze position (see Fig. 4d):
 FX ≈ RW ≈ LJ
 RW & LJ: variance of stimulus sensitive group smaller than task focused group.

→ RW & LJ tend to affect control of retinal image motion in stimulus sensitive group.

← Figure 4d: Statistics of inertia (log-scale) of retinal image shifts per condition and participant group.

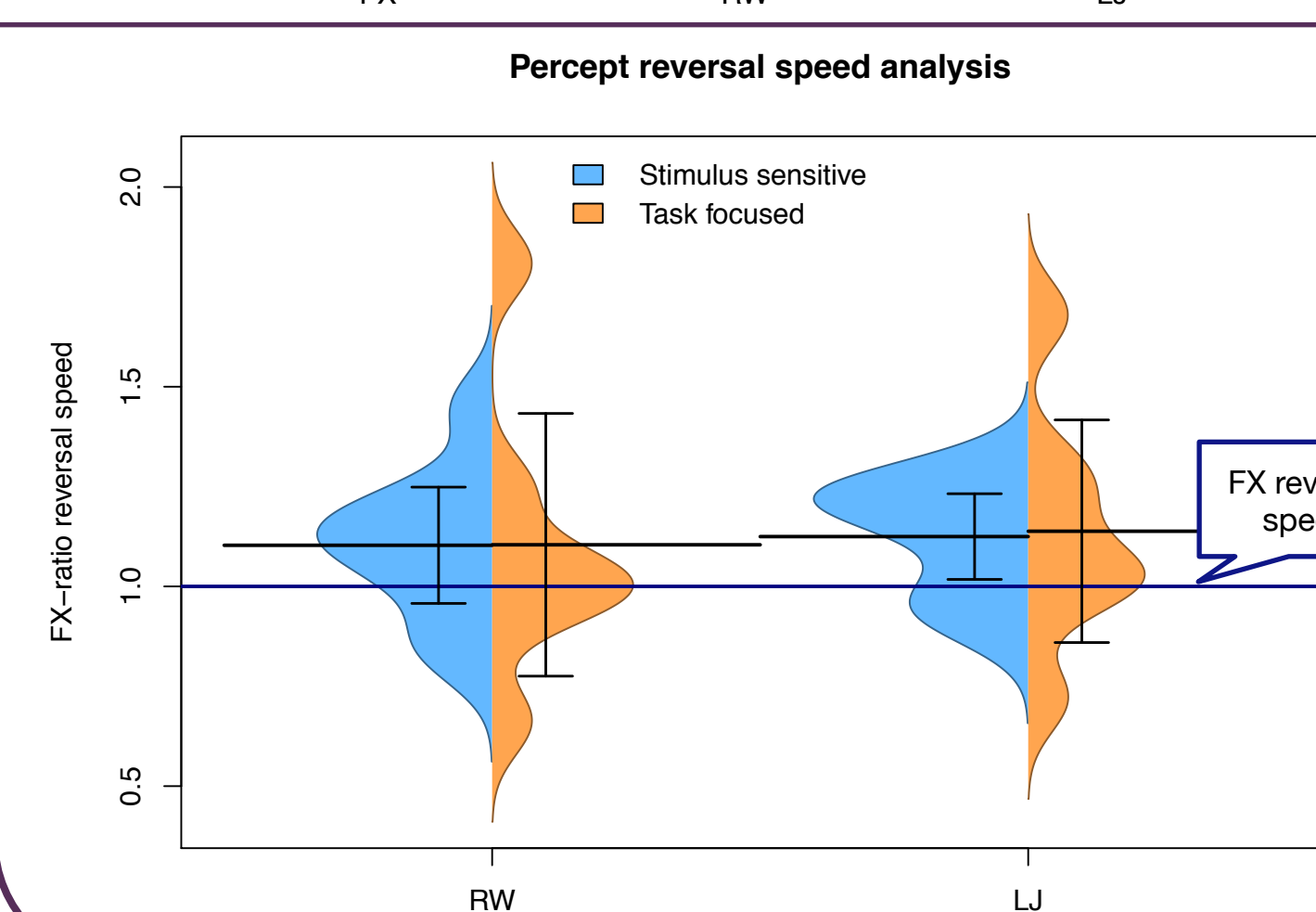

Results (post ocular analysis - Fig. 4e):

- Effect of **motion** on reversal speed on stimulus sensitive group in LJ.
- Effect of **predictability** of motion on reversal speed: RW ≈ LJ → retinal image stabilization does not explain bistable perception dynamics results.

← Figure 4e: Reversal speed per condition with distinction of participant groups.

Conclusions

Stimulus motion leads to an increase in reversal speed as predicted by models but effect size is small.

Predictability of motion does not modulate noise and adaptation as expected. Retinal image shifts partially compensated by micro-smooth pursuits but does not suffice to explain behavioral results.

Experimental observations: **Micro-movements of the eyes in the form of approximate smooth pursuits** within fixation events detected → not studied in the context of multi-stability to our knowledge

→ development of a **multi-stable gravitational attractor-based model of fixational eye movements** (Parisot et al., ECVF 2017).

References

Blake, R., Sobel, K. V., & Gilroy, L. A. (2003). Visual motion retards alternations between conflicting perceptual interpretations. *Neuron*, 39(5), 869-878.

Leopold, D. A., & Logothetis, N. K. (1999). Multistable phenomena: changing views in perception. *Trends in cognitive sciences*, 3(7), 254-264.

Kornmeier, J., & Bach, M. (2005). The Necker cube—an ambiguous figure disambiguated in early visual processing. *Vision research*, 45(8), 955-960.

Shpiro, A., Moreno-Bote, R., Rubin, N., & Rinzel, J. (2009). Balance between noise and adaptation in competition models of perceptual bistability. *Journal of computational neuroscience*, 27(1), 37-54.

Moreno-Bote, R., Knill, D. C., & Pouget, A. (2011). Bayesian sampling in visual perception. *Proceedings of the National Academy of Sciences*, 108(30), 12491-12496.