



Large area diamond detectors for fast beam tagging applications in particle therapy

D. Dauvergne, A. Bes, G. Bosson, J. Collot, S. Curtoni, L. Gallin-Martel, ML. Gallin-Martel, A. Ghimouz, J.-Y. Hostachy, A. Lacoste, S. Marcatili, J-F. Muraz, F. Rarbi, O. Rossetto, M. Yamouni
LPSC Grenoble



M. Fontana, E. Testa
IPN Lyon



M. Salomé, J. Morse, W. De Nolf
ESRF



L. Abbassi, T. Crozes, JF. Motte
NEEL Institute



Motivation (1/5)

Need for in vivo ballistic control in particle therapy

[Knopf, PMB 2013]

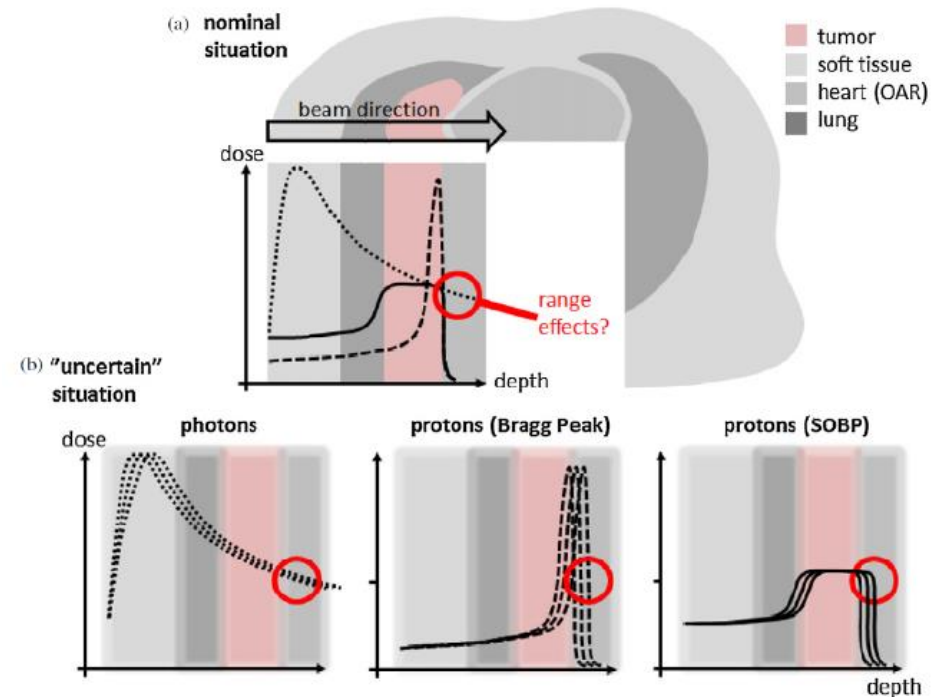

Uncertainty sources :

Dose calculation: Planification (from CT images, RBE), patient positioning, anatomic variations during treatment, moving organs/tumor

→ Margins

Strategies:

Planification: dual-energy or proton CT, Monte Carlo simulations

Online control: nuclear fragmentation products

- PET: a posteriori
- Prompt radiation: gamma, protons (ions heavier than protons)

Motivation (2/5)

Time of Flight prompt-gamma imaging with 1D collimated camera

Prompt- γ emission is correlated to ion range

[Krimmer NIMA 2017]

TOF: reduction of neutron-induced background

➤ Synchronization with beam HF

Possible with Cyclotron proton beams (IBA-C230)

160 MeV protons in PMMA (Cyclotron)

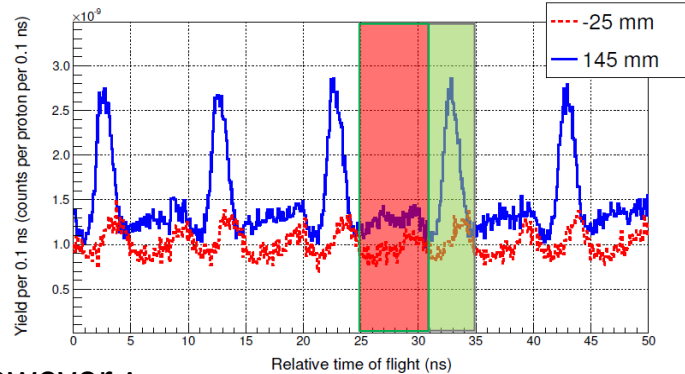

However :

Phase changes with beam energy

Limitations by bunch length (0.5 – 4 ns)

➤ Ion per ion tagging at 10^7 - 10^8 Hz

Carbon ions from synchrotrons (HIT, CNAO...): Microbunch duration >20 ns

Synchro-cyclotron proton beams (IBA S2C2): Nanobunch duration ~ 8 ns (10^4 p/bunch)

TOF \Rightarrow reduction to 1 proton/bunch necessary

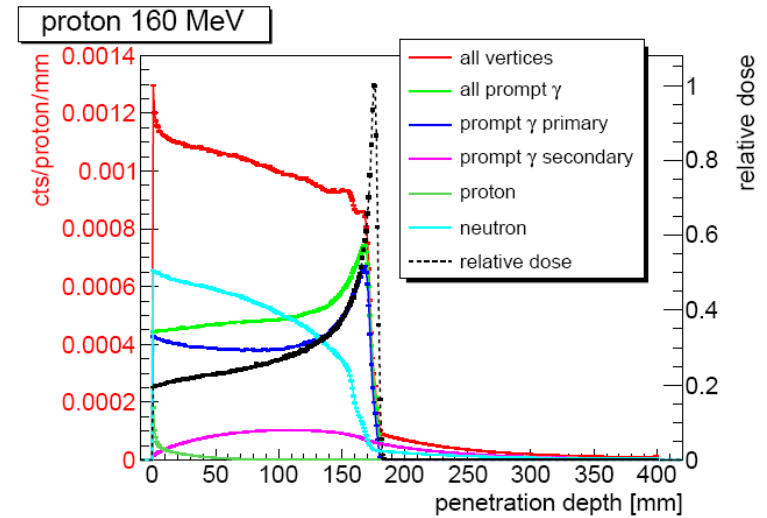

[Roellinghoff PMB 2014]

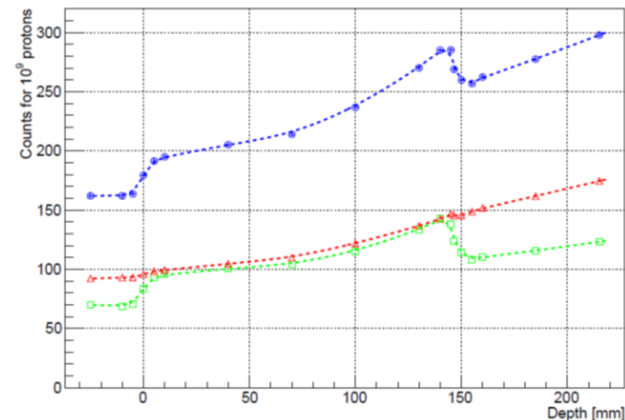

Motivation (3/5)

Spatial resolution issue

- Heterogeneities influence ion range and prompt-gamma yield

95 MeV/u carbon ions in PMMA
2 mm collimation slit

[Pinto Med Phys 2015]

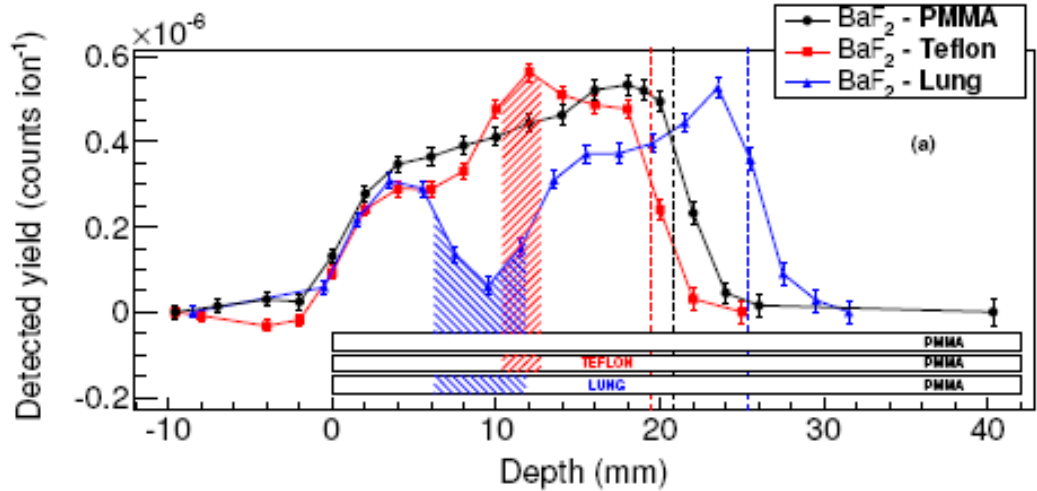

- Gamma imaging: compromise between spatial resolution and efficiency (statistics issue)

Proposed solution by IBA:
Knife-edge camera
(~2 cm spatial resolution)

[Richter, RaOn 2016]

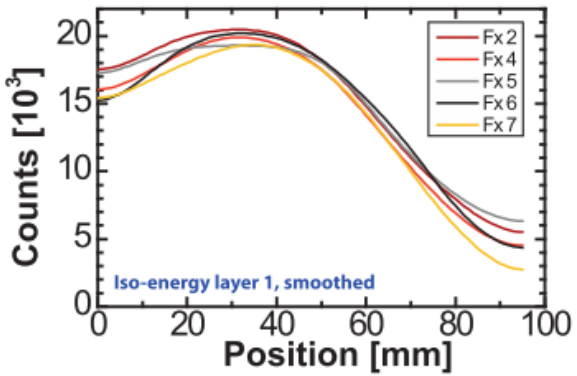

- Ultra-fast timing resolution will improve spatial resolution

Motivation (4/5)

Compton imaging with beam hodoscope

CLaRyS collaboration (IPN Lyon, CPPM Marseille, LPC Clermont, LPSC Grenoble)

Potentially higher detection efficiency than collimated devices

- Beam hodoscope: line-cone intersection

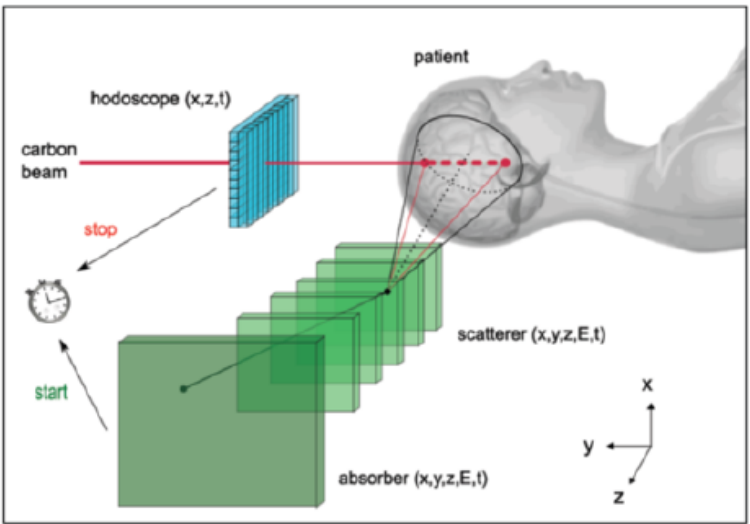

Distance between cone intersections

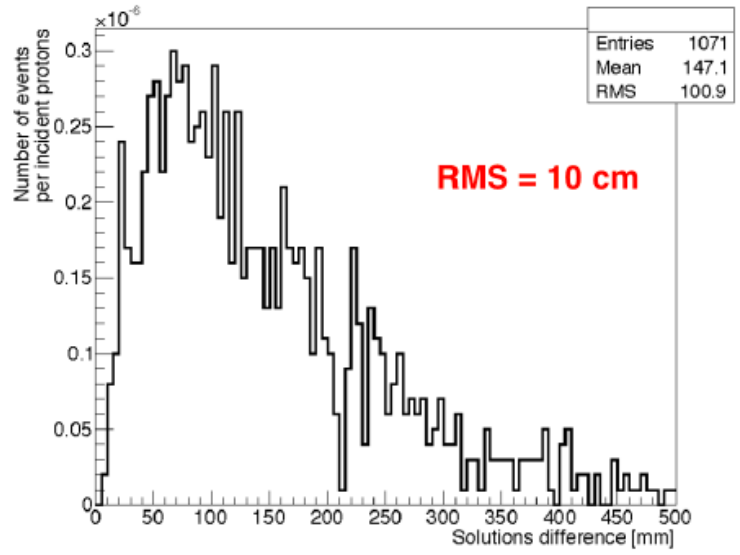

[Ley PhD 2015]

- TOF resolution < 500 ps → real time Compton imaging

Motivation (5/5)

Prompt-gamma counting solutions

- Prompt- γ timing

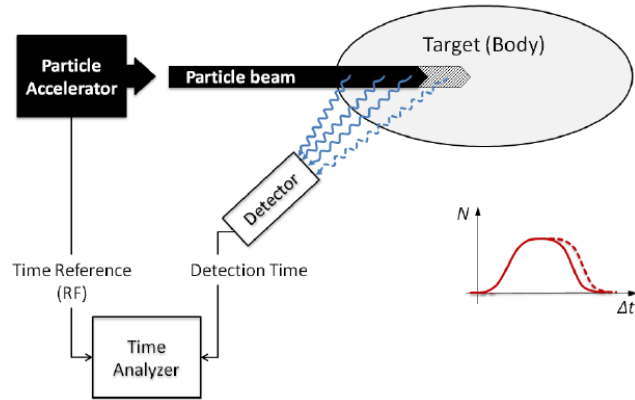

- Average time and shape related to proton range
- 5mm range shift measurable with single spot
- Requires high timing resolution (< 1ns)
- Limitations:
 - Cyclotrons
 - Bunch time spread

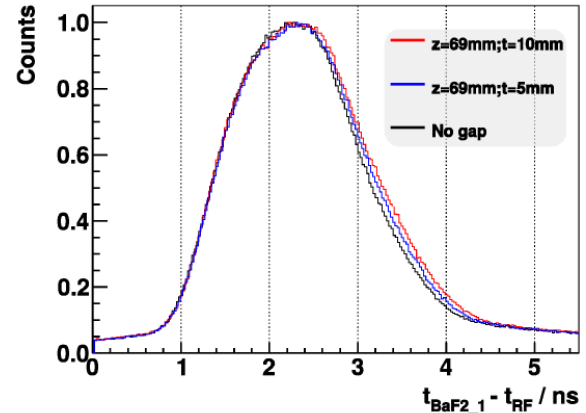

[Hueso-Gonzalez PMB 2015]

- Prompt- γ Peak Integral [Krimmer APL 2017]

- 2-4 ns time window selection: PG issued from patient
- Yield depends on energy deposited, beam position

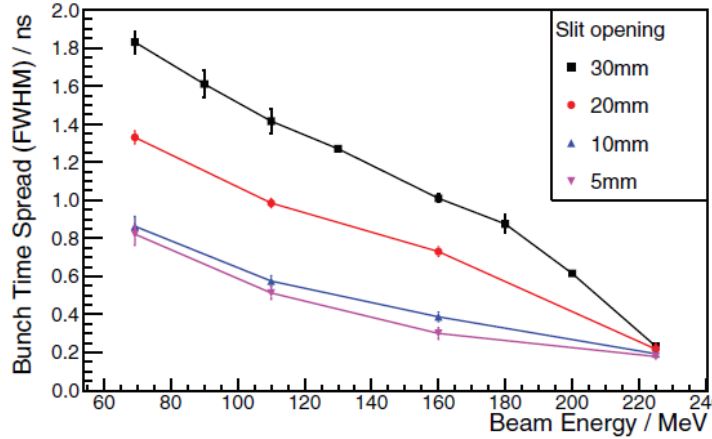

[Petzoldt PMB 2016]

- Both methods would benefit from fast and high-resolution beam-tagging system

Beam tagging hodoscope development : LPSC MoniDiam project (within CLaRyS collaboration)

Existing development (CLaRyS) :

Array of scintillating fibres coupled to multichannel photomultiplier tubes (PMT).
Fast readout with μ TCA acquisition under test.



Limitations :

- Radiation hardness
- PMT count rate capability (10^7 cps per PMT)
- Time resolution 500 ps – 1 ns

Foreseen development :

MoniDiam : diamond based hodoscope and its dedicated integrated fast read-out electronics for 100 ps resolution

Diamond Assets :

- Intrinsic radiation hardness
- Fast signal risetime enables timing precision of a few tens of ps
- Low noise

Issues :

- Cost
- Availability of large area

Solution : Assembly of double-side stripped diamond, polycrystalline or DOI

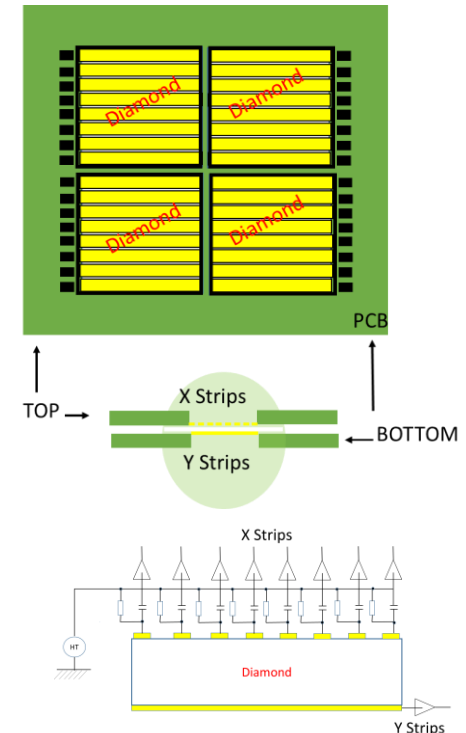

First tests: single disk-shape metallized diamonds

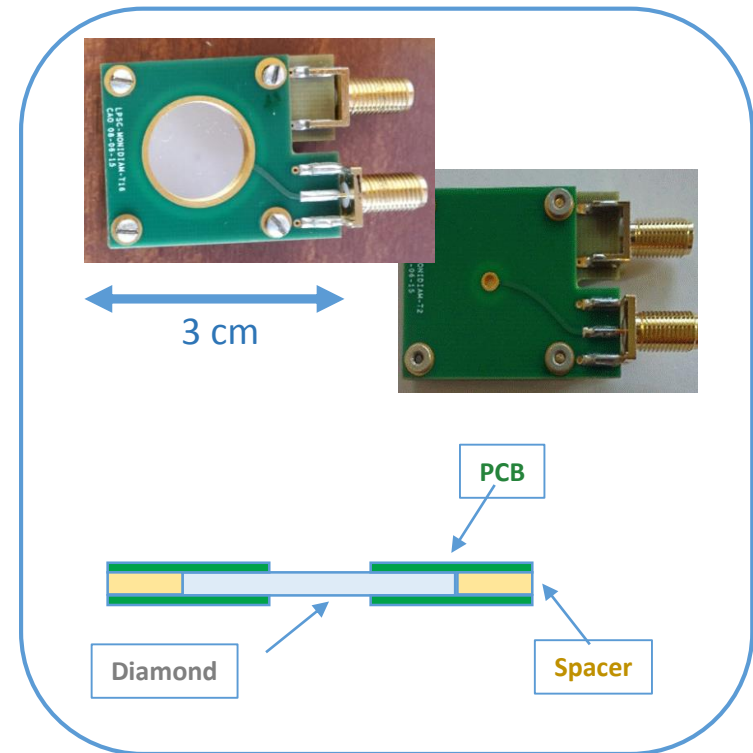
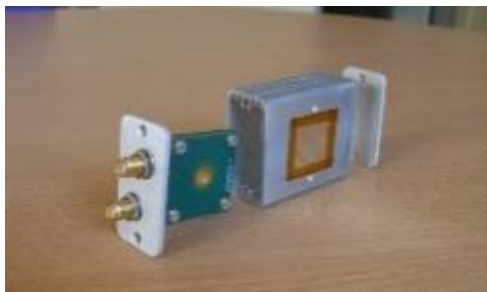
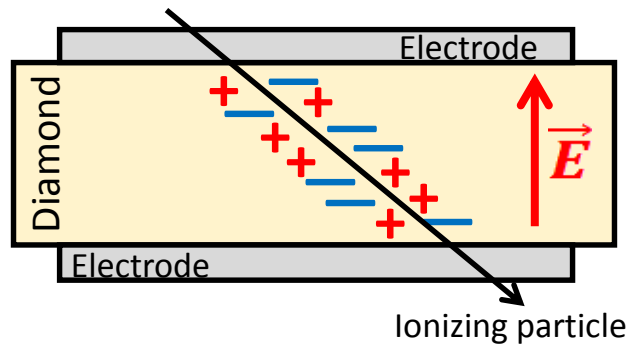

Diamond detector characterization: test benches at LPSC

Alpha source (^{241}Am – 5.4 MeV)

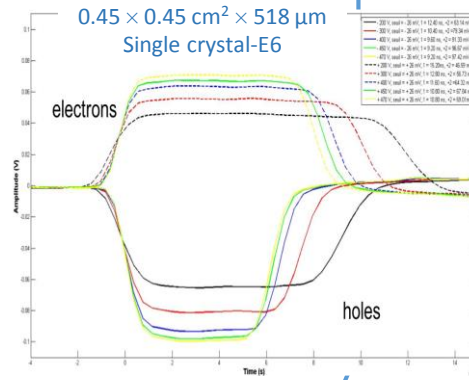
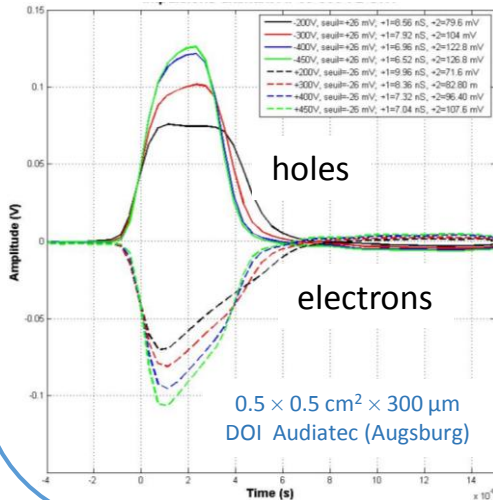
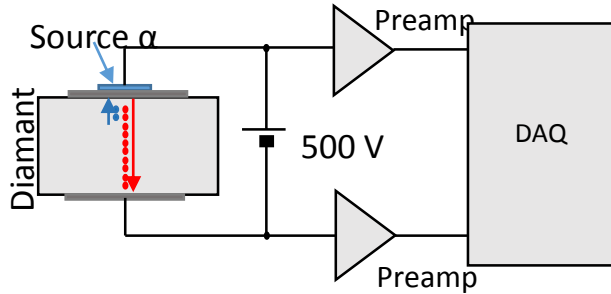

Beta source (^{90}Sr)

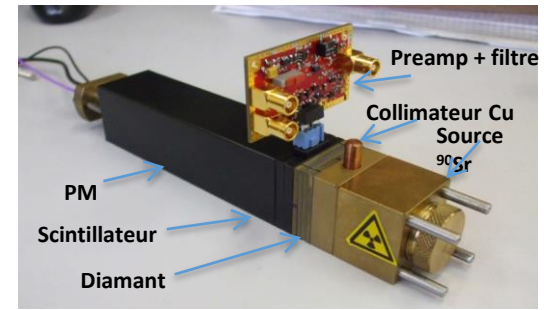

Charge collection efficiency (single crystal)

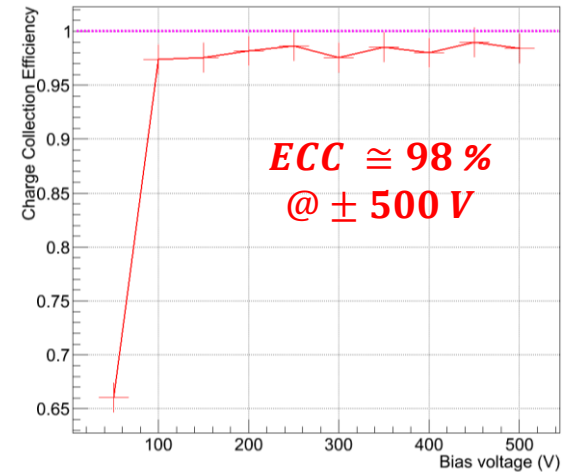

Data acquisition:



Wave catcher 500 MHz
3.2 Gs/s, 8 channels



Wave-runner Lecroy 4GHz
40Gs/s

Beam test at GANIL : 95 MeV/u ^{12}C

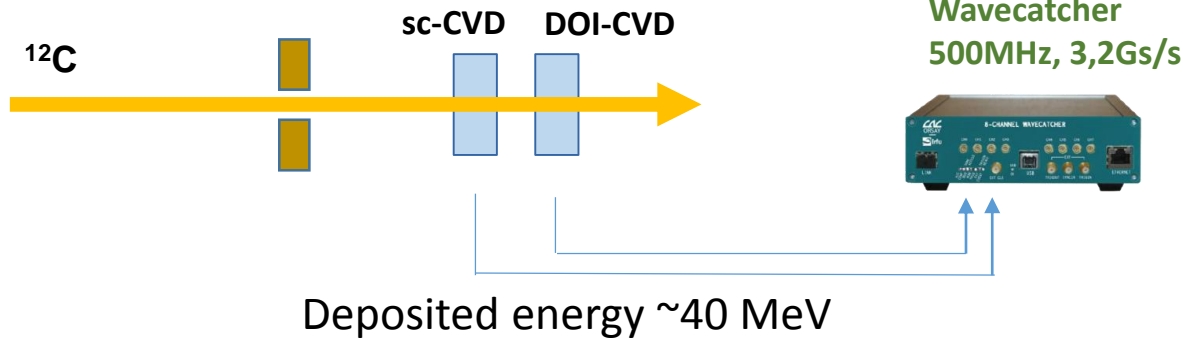

Monocrystalline :

sc-CVD E6 + DBA III
0.45 x 0.45 cm² x 518 μm

Hetero-epitaxial :

DOI-CVD Audiatec + Cividec C2
0.5 x 0.5 cm² x 300 μm

Timing resolution Mono vs DOI

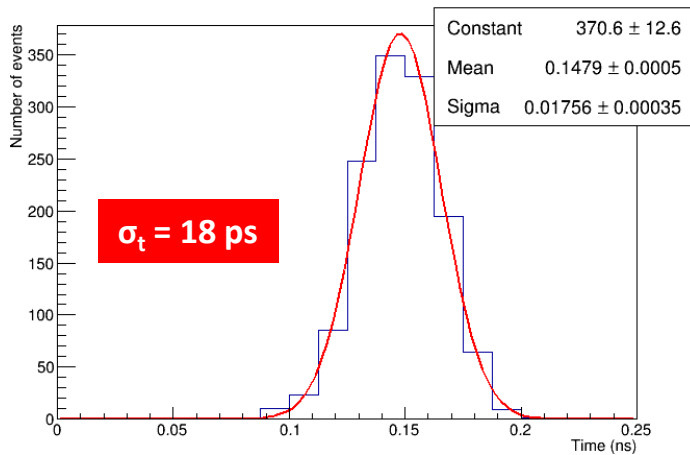

Energy resolution DOI

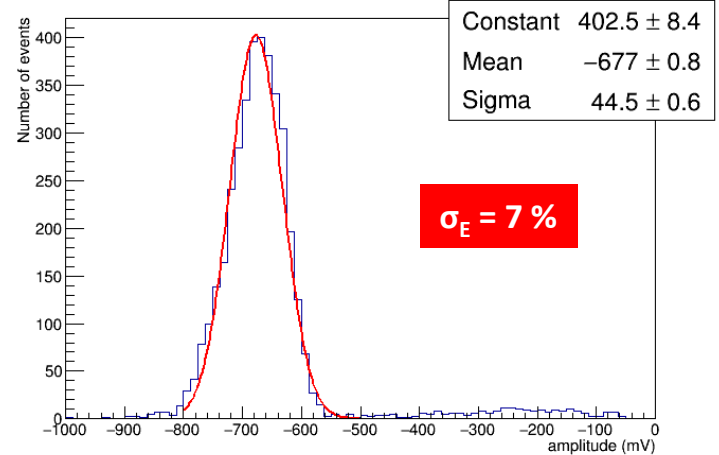

Beam test at GANIL : Time of flight measurements

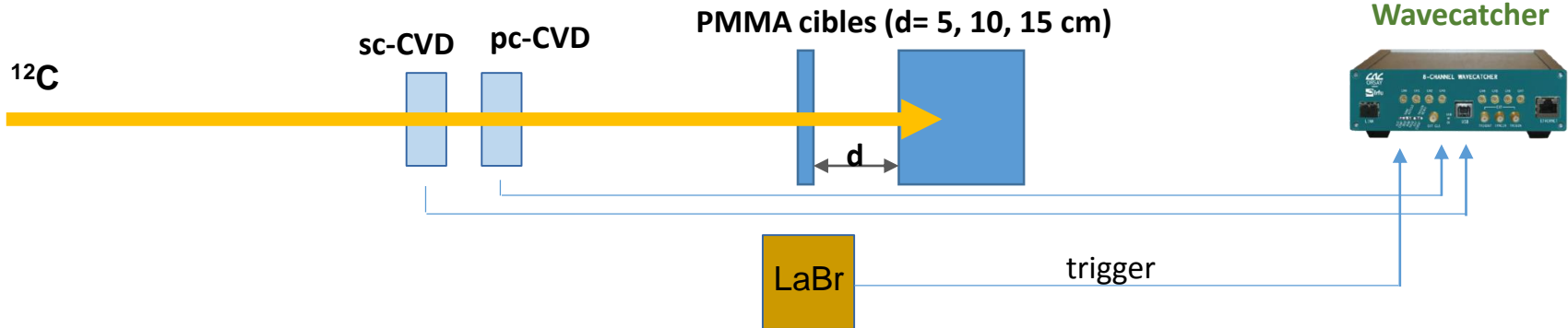

Simulation G4 :
TOF distribution LaBr vs. sc-CVD E6

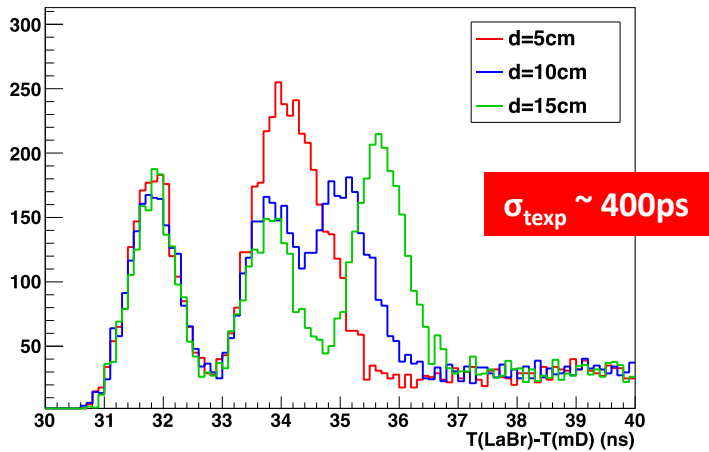

Prompt Gamma Timing (d = 15cm)

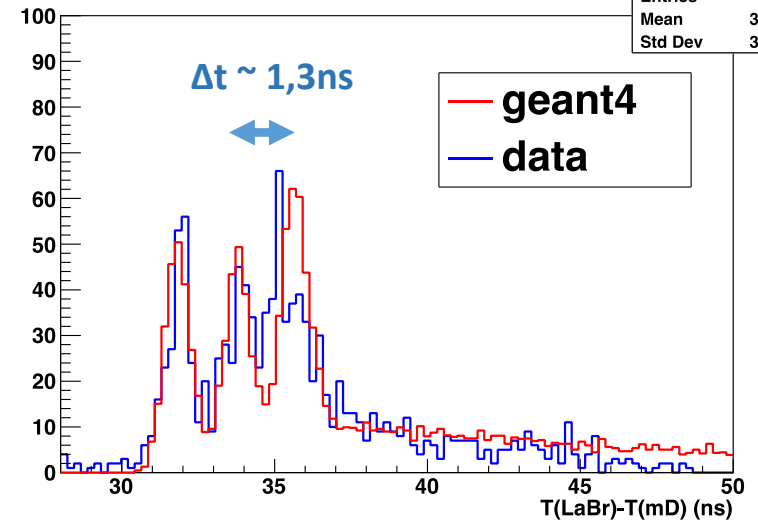

Beam test at ESRF : XBIC source at 8.5 keV

Continuous energy deposit (0 to 4 MeV)

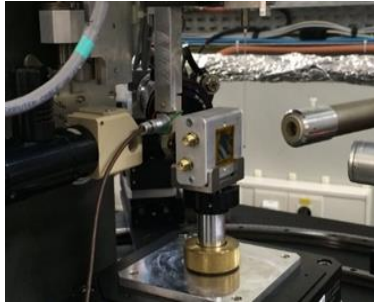

Spot $\sim 1 \mu\text{m}$
 ~ 1500 photons/bunch
 Bunch width = 100ps

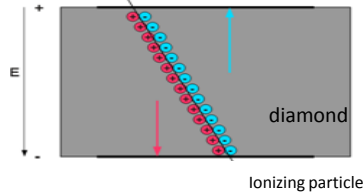

Timing resolution

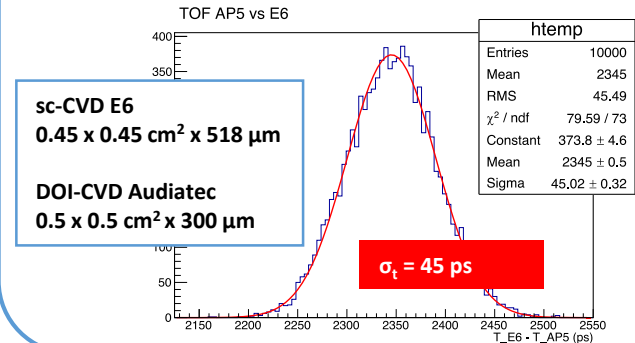

Poly-crystalline

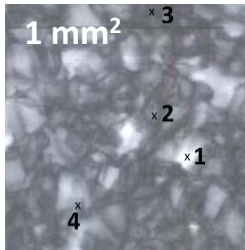

$10 \times 10 \text{ mm}^2 \times 500 \mu\text{m}$ pc-CVD

Current response map

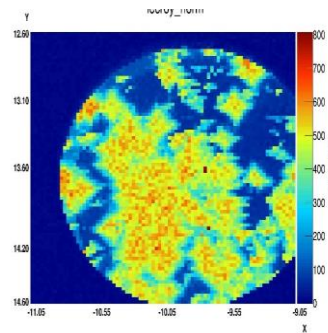
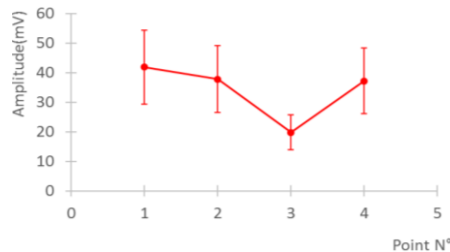

DOI

Non-homogenous response

$5 \times 5 \text{ mm}^2 \times 300 \mu\text{m}$ DOI-CVD

Beam test at ESRF : XBIC source at 8.5 keV

Continuous energy deposit (0 to 4 MeV)

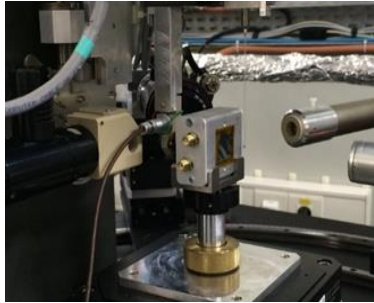

Spot $\sim 1 \mu\text{m}$
 ~ 1500 photons/bunch
Bunch width = 100ps

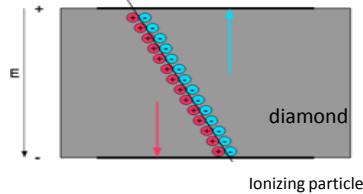

Time resolution

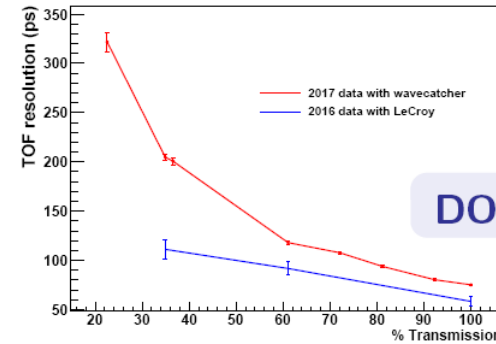

DOI vs DOI

TOF resolution: DOI vs sc-CVD

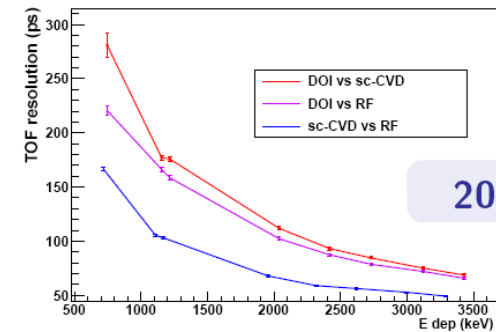

2017 data

Although noisy conditions in 2017
100 ps resolution reasonable

Stripped diamond characterization

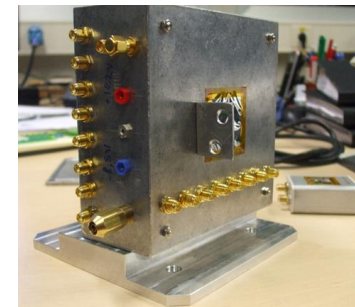
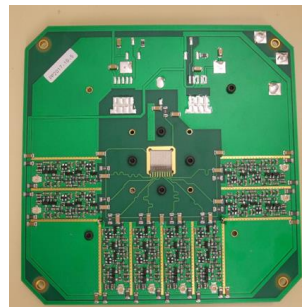
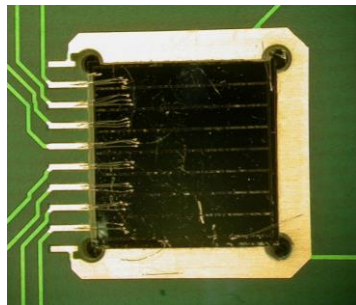
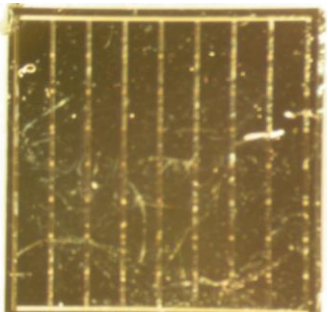
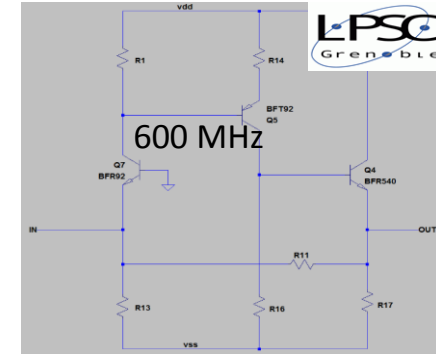
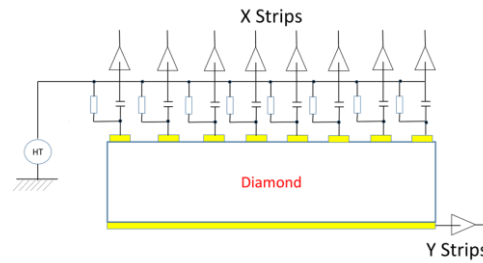
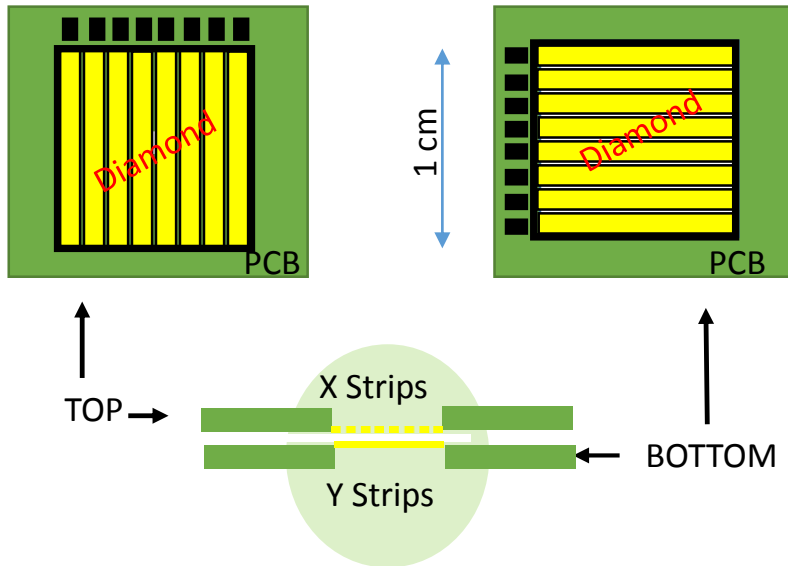

NANOFAB Neel Institut Grenoble
 100 nm Al deposition by UV lithography
 Wire bonding

LPSC Grenoble
 PCB design
 Current preamplifier
 Detector assembly

Beam test at ESRF : XBIC source at 8.5 keV

Surface Analysis

Current-integration mode

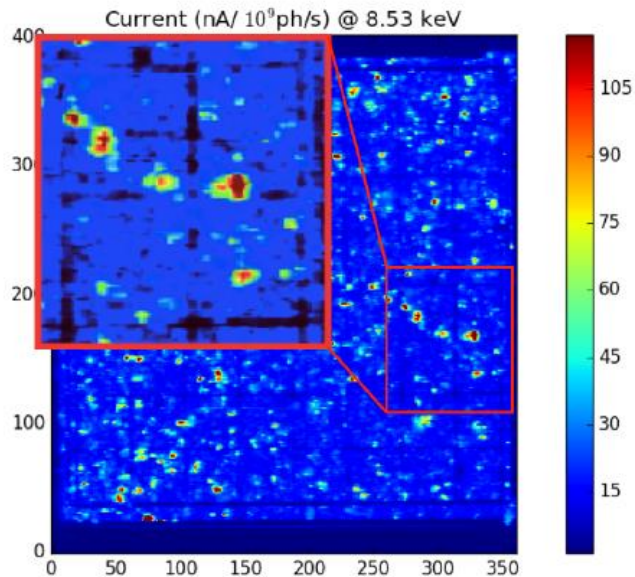

1 × 1 cm² × 300 μm
pc-CVD from Element 6

XBIC detector scan (100 μm step)

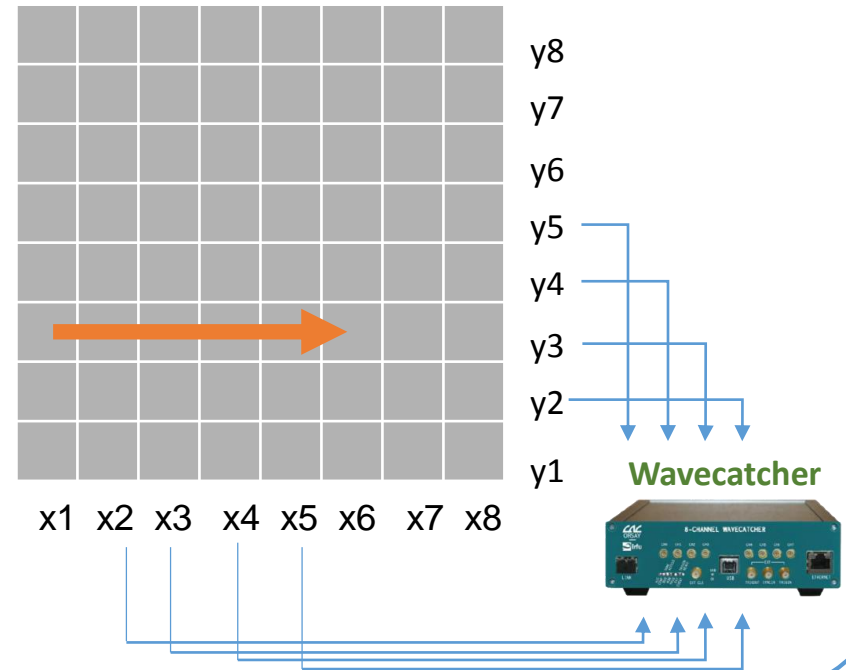

First results



Timing resolution

Time difference between Y3 and X signals: CF at 50%

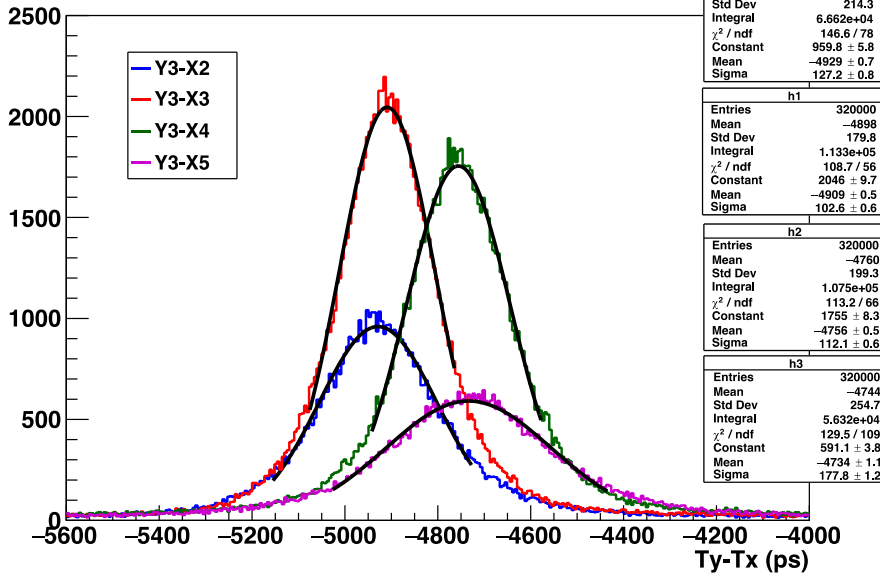

Best result: $\sigma_t = 103$ ps

Reconstructed position

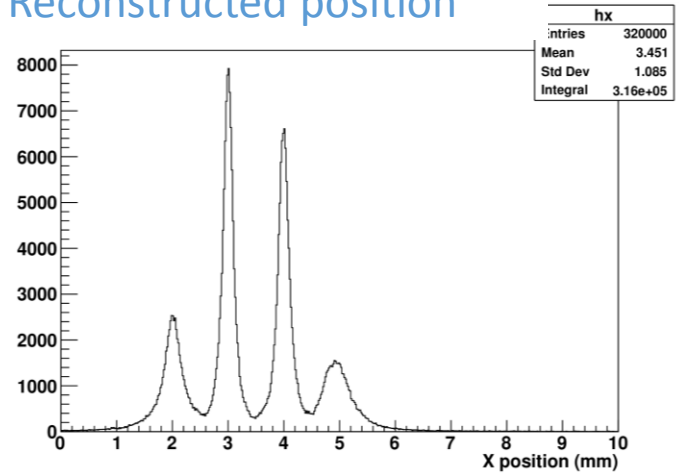

Detection efficiency

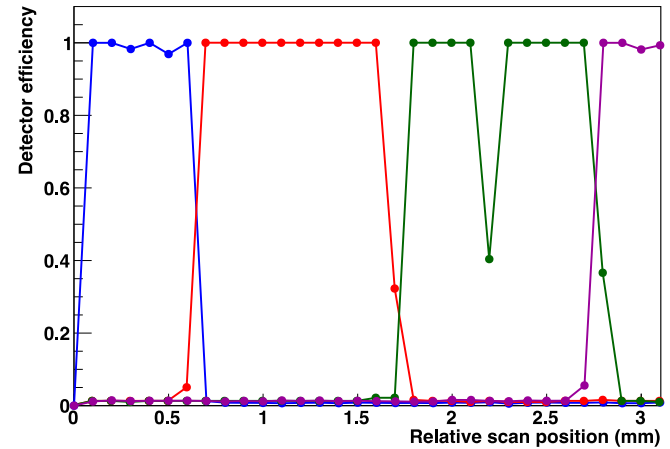

Front-End Electronics: Architecture

- 130nm CMOS TIA + Fast Discriminator
 - Radhard technology
 - Wide bandwidth, Low noise TIA

TIA Parameters	Value
A_0	> 60 dB
F_{-3dB}	1.2 GHz
Z_{in}	20 – 50 Ω
$V_{n,out}$ (output noise)	< 1 mV _{RMS}
Input Dynamic range	3 μ A – 120 μ A (<1% linearity)

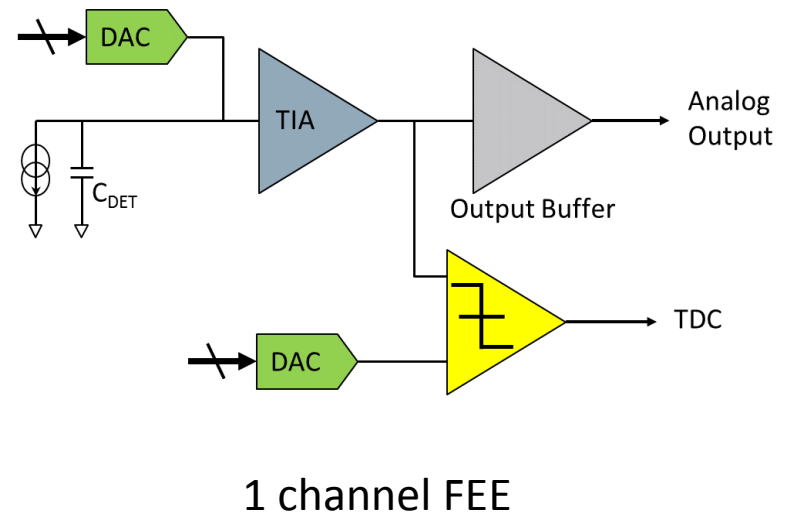

Front-End Electronics: Simulation

- Simulation parameters:
 - Extracted view + Noise tran
 - With bonding wires (2nH): Power supply, ground and input signal
 - Multi-gain discriminator
 - Jitter estimation: from 3 μA to 120 μA input signal

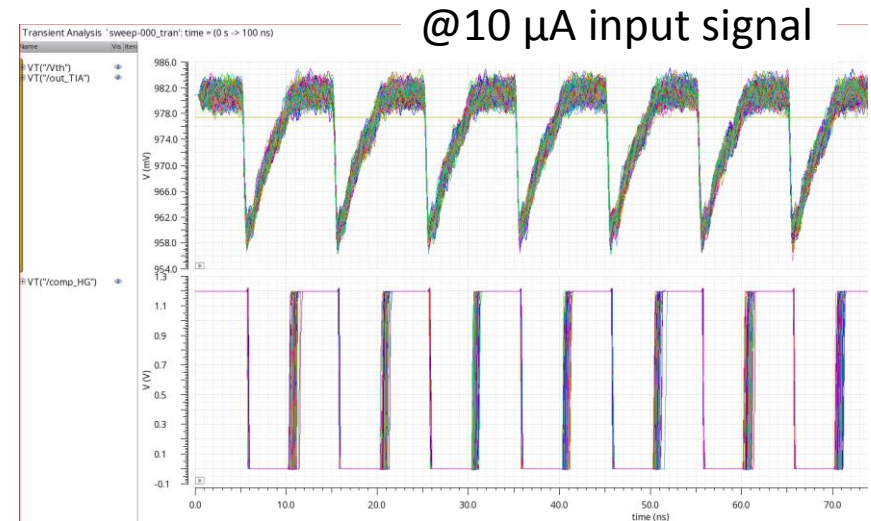
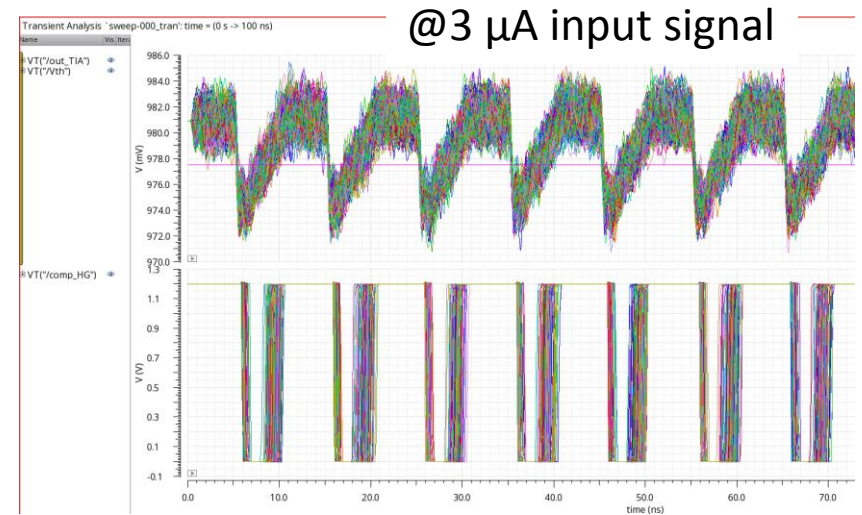
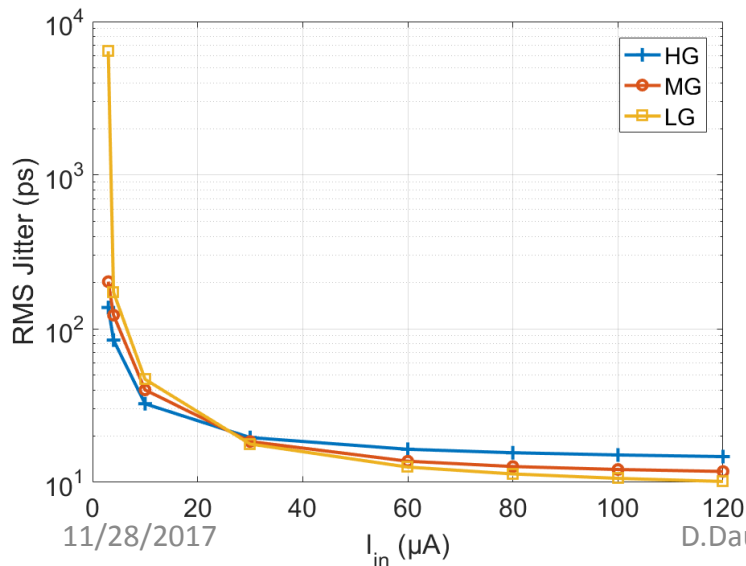

Front-End Electronics: Layout

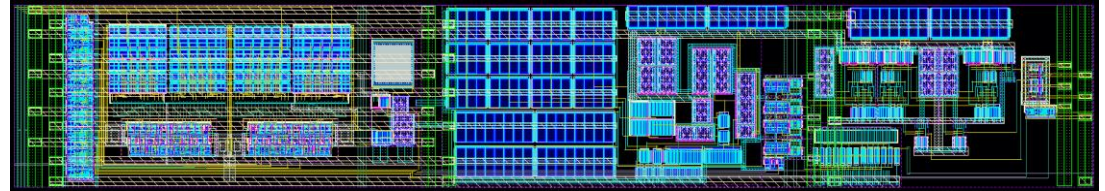

- 130nm CMOS
 - 8 channels FEE: TIA + Discriminator
 - Will be submitted on December 2017

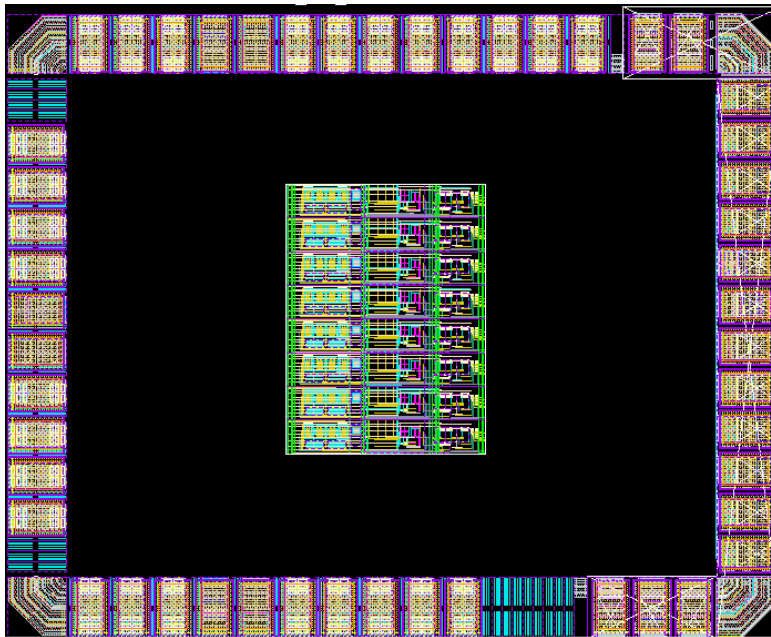

1.485 x 1.2 mm²

Conclusion

- Characterization of the performances of small and medium size detectors with sources, ions, and synchrotron
- Multi-strip detectors: a first prototype of 1 cm² has been developed and tested with discrete electronics
- Micro-electronics readout under development (technical collab. with LPC-Caen)
- Framework:
 - Local: ESRF, NEEL:
 - local pole for detector and electronic devices
 - crystal processing and characterization
 - National: LSPM, IPHC, CEA-LIST and CLaRyS collaboration (+CAL-Nice, Arronax...)
 - International: RD42

Acknowledgements



The authors would like to acknowledge the **ESRF** for provision of synchrotron radiation facilities and would like to thank the ID21 beamline staff for their assistance with experiment MI-1243.

This work was supported by the Labex **PRIMES** (ANR-11-LABX-0063), **FranceHadron** (ANR-11-INBS-0007) and **ANR MONODIAM-HE** (ANR-089520).

The **CLARA** Canceropole (Oncostarter Project) is thanked.

The authors are grateful to **Matthias Schreck** from the Augsburg University for providing the LPSC laboratory with samples of diamond heteroepitaxially grown.

Dominique Breton from the Laboratoire de l'Accélérateur Linéaire and **Eric Delagnes** from CEA Saclay are thanked for their implication in dedicated software development and technical support of the namely "wavecatcher" data acquisition system.