



**HAL**  
open science

# Optimal Design of Inductors -Transformers Associated to Converters for Railway Application

M. Rossi, Michel Hecquet, V Lanfranchi, J Bousaada, B. Lefebvre

► **To cite this version:**

M. Rossi, Michel Hecquet, V Lanfranchi, J Bousaada, B. Lefebvre. Optimal Design of Inductors - Transformers Associated to Converters for Railway Application. COMPUMAG Congress, Jul 2011, Sydney, Australia. hal-01715690

**HAL Id: hal-01715690**

**<https://hal.science/hal-01715690>**

Submitted on 22 Feb 2018

**HAL** is a multi-disciplinary open access archive for the deposit and dissemination of scientific research documents, whether they are published or not. The documents may come from teaching and research institutions in France or abroad, or from public or private research centers.

L'archive ouverte pluridisciplinaire **HAL**, est destinée au dépôt et à la diffusion de documents scientifiques de niveau recherche, publiés ou non, émanant des établissements d'enseignement et de recherche français ou étrangers, des laboratoires publics ou privés.

# Optimal Design of Inductors - Transformers Associated to Converters for Railway Application

M. Rossi<sup>1</sup>, M. Hecquet<sup>1</sup>, V. Lanfranchi<sup>2</sup>, J. Bousaada<sup>3</sup>, B. Lefebvre<sup>4</sup>

<sup>1</sup>Univ. Lille Nord de France, ECLille, L2EP

<sup>2</sup>Univ. of Technology of Compiègne, France, LEC

<sup>3</sup>Alstom-Transport Charleroi, Belgium

<sup>4</sup>Transrail Boige & Vignal, France

Nowadays, power converters in railway domain are more and more compact and powerful. This progress is due to the use of fast efficient components, working at high frequency like IGBT. But this evolution generates many harmonics losses in different components as inductors or transformers, and complicates their design. In addition, for the design stage, acoustics comfort is an increasingly important factor. Hence, it is necessary to develop multi-physic models in order to integrate different phenomena as the PWM effects, the temperature, and the noise. These models are coupled to an optimization tool in order to define the design rules of passive components: inductors or transformers coupled with inductor for the railway application.

**Index Terms**— Design optimization, Electromagnetic modeling, Inductors, Power transformers.

## I. INTRODUCTION

Even if some well-known finite element analysis tools can compute the magnetic components characteristics, their coupling can be tedious and their computational time is usually prohibitive, particularly in an optimization process. It's necessary to develop fast models with a good compromise between the accuracy of field calculations.

The aim of this paper is to optimize the design of magnetic components in order to minimize their weight and losses. To achieve this goal, a multi-physical model is used, based on nodal models to keep a good ratio between accuracy and computation time. Firstly the different models are presented, following by the optimization part. In this last part, optimal designs are presented for the case of a three-phase inductor. Influence of variables on objective functions are shown and explained.

## II. MULTI-PHYSICS MODELING

Magnetic components, such as transformers and industrial inductors, bring into play a vast range of physical domains, such as electromagnetic, thermal and, in a lesser way, acoustic. All those physical phenomena interact onto each other, in a more or less strong way.

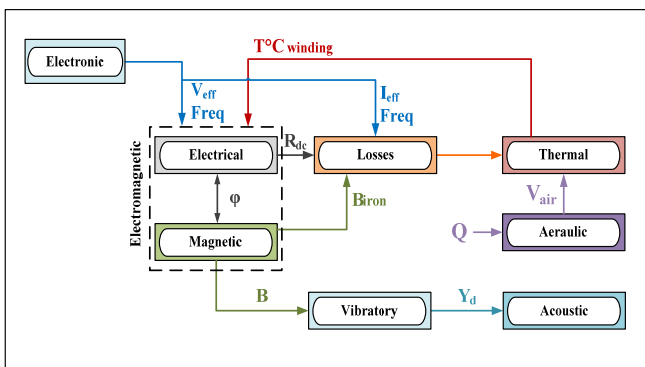

Fig. 1. Multi-physic problem with physical couplings

Hence, any design process has to be taken into consideration by a multi-physical point of view. As an illustration, a synthesis of the different physical domains and their interactions between each other is shown Fig.1. The voltage and current spectrums are imposed.

### A. Electro-Magnetic model

The magnetic model is analytical and contains many assumptions. The field is considered only in one dimension, and conductors are assimilated to semi-infinite plate conductors. These hypothesis allow estimating analytically the magnetic field into the magnetic core and along the winding including in air-duct. The effects of frequency are taken into account. Firstly the field is computed using the Ampere's circuital law (1). This determination is only validated at low frequency.

$$\int H \cdot dl = i \quad (1)$$

When the frequency increase, the field in the copper is concentrated on the side of the conductor. This is due to the skin and proximity effects. Magnetic field can be computed using Helmotz equation (2)

$$\frac{\partial^2 H(x)}{\partial x^2} = j \cdot \omega \cdot \mu_w \cdot \sigma_w \cdot H(x) \quad (2)$$

The magnetic field is calculated for each harmonic of current. Thanks to that, leakage, mutual and magnetizing inductances can be estimated by integrated the field along the winding.

### B. Losses model

Iron losses ( $P_{iron}$ ) calculation is based on Steinmetz model [1]. The Equation (3) is an empirical equation which includes together hysteresis and eddy current phenomena.

$$P_{iron} = K_C \cdot f^\alpha \cdot B^\beta \cdot V_C \quad (3)$$

The Iron losses only depend of the induction  $B$ , the frequency  $f$  and the volume of the magnetic core  $V_c$ . Steinmetz equation is very practical because parameters are easily obtained thanks to datasheets provided by steel manufacturer.  $\alpha$ ,  $\beta$  and  $K_c$  are determined by linear regression on losses curve. To improve the model of losses, hysteresis and eddy current phenomena can be studied separately [2]. But in this case, parameters of equations are not directly available and experimental measurements are necessary to adjust the model.

Harmonics are taken into account. For each one,  $P_{iron}$  is calculated and finally the total iron losses are obtained by summing each  $P_{iron}$ . We apply the method of superposition which remains valid for linear systems. Given the assumptions, the operating point remains in the linear area of B(H) curve.

Winding losses ( $P_j$ ) are generated by Joules Law which only depends of current and the electrical resistance of coils (4). The current density is the derivative function of the magnetic field  $H(x)$  for each harmonic (5). The Figure 2 illustrates the current density into the different winding layers for inductors. Domino effect appears and losses are not equally distributed into the winding

$$P_j = \frac{\left[ \int J dS \right]^2}{\int \frac{\sigma}{l} dS} \quad (4)$$

Where  $J$ ,  $\sigma$  and  $l$  are respectively the current density, the electrical conductivity and the length of coil.

$$J(x) = \frac{dH(x)}{dx} \quad (5)$$

This method allows to take account of high frequency effects as skin and proximity effects. The same hypothesis was applied by Dowell [3] at the difference that [3] generalizes the calculation for transformer with only one primary and one secondary. This permits to write losses as (6).

$$P_j = R_w I_{eff}^2 = F_r R_{DC} I_{eff} \quad (6)$$

Where  $R_w$  is the effective resistance,  $R_{DC}$  the resistance measured with DC current, and  $F_r$  the additional losses factor

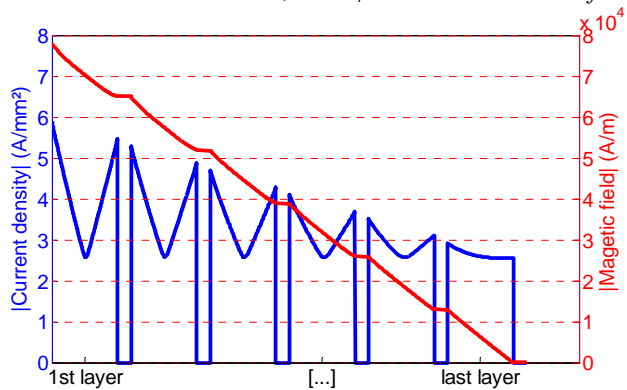

Fig. 2. Current density and magnetic field into the different layers of an inductor.

### C. Thermal model

Thermal study can be separated in three phenomena: conduction, forced convection and radiation. The last one is negligible in the case of air-forced cooling [4]. Only the steady state is studying which allow the suppression of thermal capacitances. The specifications of the model are the ability to estimate temperature in:

- Each layer of winding along the core,
- The magnetic core,
- The air ducts according to their size and position.

Fig. 3. Part of the 3D Network of a layer of winding

The nodal approach has been chosen for thermal simulation to allow the observation of local phenomena as hot spot contrary to analytical model which gives only average temperature [5],[6].

The aims of this thermal model are the ability to evaluate the temperature in three parts of the system: in each layer of the winding along the core, inside the core and in the air ducts according to their size and position. Since analytical models can only supply average temperature, a 3D nodal network approach has been chosen for the thermal simulation.

In term of industrial inductors, vast range geometry exists. Hence, the flexibility of the network construction is important so it has the ability to adapt the network to the system geometry. An algorithm has been implemented to generate automatically the network of one of the industrial inductor's column with its windings and air ducts. This topology is described in [7] and Fig. 3. For each node of the network, the Kirchhoff's current law is applied. Thermal Result is exposed in Fig. 4 for a DC inductor.

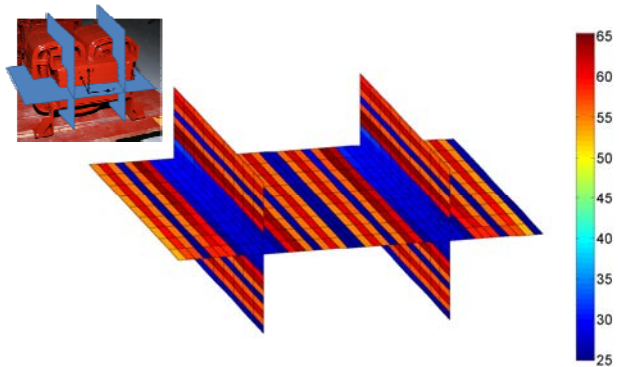

Fig. 4. Thermal simulation of a DC inductor

D. Vibro-Acoustic model

A spring mass model could be made by considering the two columns of the core as beams [8]. Hence, those beams can be discretized in N elemental harmonic oscillators. This model has been validated on classic beams made of pure material (like iron for example) coupled to a mass at the end of the chain. The results have been compared with finite elements simulations.

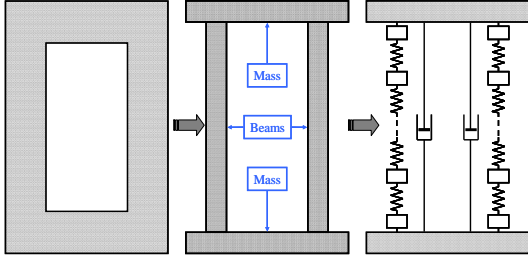

Fig. 5: spring mass model

The values of each elemental mass  $m_d$  and spring constant  $k_d$  can be expressed as follows (7):

$$m_d = \frac{m}{N} // kd = \frac{E * S}{(L / N)} \tag{7}$$

III. GENERAL OPTIMAL DESIGN

This part deals with the creation of an automatic design tool. To achieve this goal, the presented multi-physical model is inserting into an optimization loop. This one has the mission to find the optimal design parameters in order to respect constraints and minimize objectives.

In this paper, Bi-objective optimization is presented, trying to minimize weight and total losses of an three phases inductor 1.1mH-180A<sub>eff</sub>. Study of DC inductors is detailed in [10]. Current in the winding is imposed in the specifications of the component. It is composed of many current harmonics (Fig. 6)

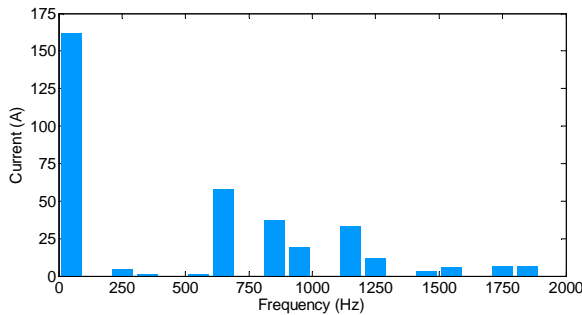

Fig. 6. Imposed spectrum current

The choice of the kind of optimization algorithm is consequential. It defines the ability of the tool to converge quickly to optimal designs with robustness. Many algorithms exist, as stochastic or gradient methods. In this tool, NSGA-II [9] has been selected. Genetic Algorithms are efficient to find global optimum in a large space of research with many variables. More over NSGA-II is able to treat multi objective

problems. Two constraints are imposed:

- A thermal Hot-Spot lower than 90°C.
- Full winding layers, so that number of layers and number of turns are multiple.

Ten design variables are selected and bound in the algorithm (Table 1). Other variables could be added in the future as wire material, and insulation. The component specifications are imposed. This is the case for the spectrum current, air cooling system etc.

Variable	Description	Bound
B(T)	Maximal induction	[0.5 1.8]
N <sub>s</sub>	Number of turns	[10 100]
J (A.mm <sup>-2</sup> )	Current density	]0 4]
α <sub>wire</sub>	Wire shape factor	]0 1]
α <sub>mag</sub>	Magnetic core shape factor	[0.3 3]
N <sub>ducts-side</sub>	On side air duct number	[0 10]
N <sub>ducts-top</sub>	Top air duct number	[0 10]
Duct <sub>thick</sub>	Air duct thickness	]5 20]
N <sub>s/m</sub>	Ratio: Number of turn / Number of layer	]0 100]
N <sub>conductors</sub>	Number of parallel conductors	[1 10]

The wire and magnetic geometries are not directly imposed by the algorithm but obtained thanks to Induction, Number of turns, Current density and shape factors.

Many parameters are currently fixed in the study as:

- Winding material : copper
- Winding insulation: Nomex 414
- Core material: M6X
- Conductor shape: rectangular or foil

For this paper, NSGA-II is configured with an initial population of 200 elements, 40 generations and mutation is configured at 30% to promote space research. Compromise between weight and losses appears in a Pareto front (Fig. 7). Results are obtained after 15 minutes of computations with a discretization of 4 for the thermal model. This time agrees with the possibility of using this tool in a design office.

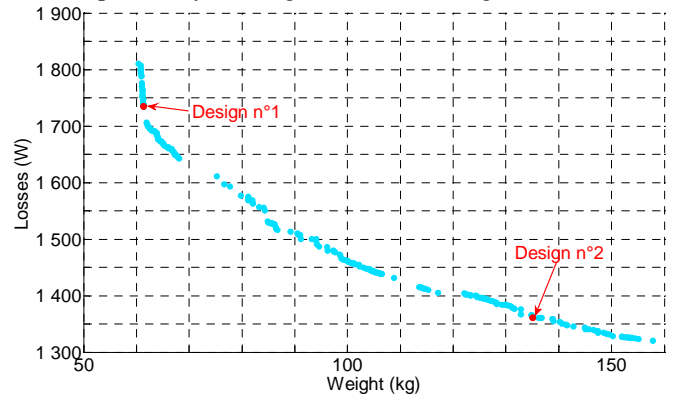

Fig. 7. Optimal designs computed by NSGA-II

Two different solutions are presented in Fig. 8. Objective functions are opposites but shape of the two components are similar, with a cubic geometry to limit volume and so the

weight. Current density and induction are higher in the first design as the second one. So temperatures in the component are more important and losses, which increase with these two parameters, grow up.

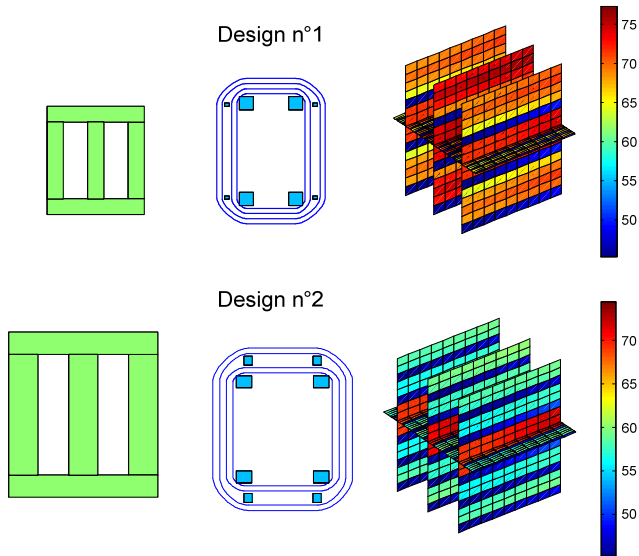

Fig. 8. Detail of two solution opposite solution

The figure 9 is composed of three times the same Pareto front but colors show the evolution of the variables B, J and  $N_s$ . Induction and current density evolve in the same way for reducing the weight. Induction is stopped at 1.6T due to thermal limitation. This is one of the most important advantages of an optimized design tool with a multi-physic model. The optimization algorithm is able to find the optimal induction by taking account of losses on temperature computation. In a traditional design, limit of induction is generally imposed by a maximal authorized losses density to avoid malfunction.

On the contrary to B, and J, the turn number doesn't evolve a lot in the front.

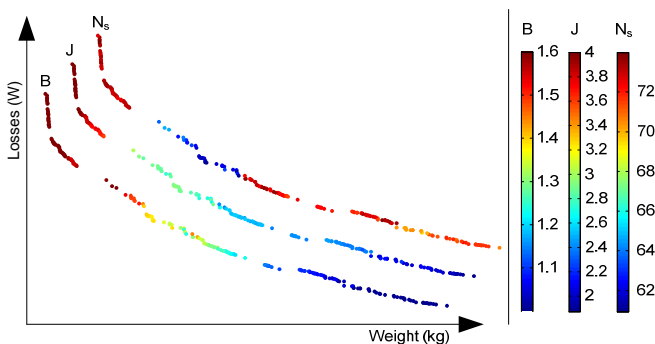

Fig. 9 Evolution of three variables in the Pareto front.

#### IV. CONCLUSION

Multi-physics modeling is realized using nodal and analytical models, which enable the possibility to observe local phenomena. Models are able to take into account of various shape and kind of magnetic components. In addition, the most important advantage is the computation time, especially in the case of optimization process which needs to launch many simulations.

The multi-objective optimization is done using NSGAI, an algorithm well adapted for the multi-physic models. The optimization process offers different geometric configurations of the machine that best satisfy the objectives while considering the imposed constraints.

Time of optimization is compatible with an industrial design process and allows component manufacturers to obtain quickly design solutions. It remains possible for the designers to simulate more precisely the components using Finite Elements tools.

#### V. ACKNOWLEDGMENT

This work was supported by MEDEE. MEDEE is co-financed by European Union. Europe is moving in Nord Pas-de-Calais with the European Regional Development Fund (ERDF)

#### VI. REFERENCES

- [1] J. Reinert, A. Brockmeyer, and R.W. De Doncker, "Calculation of losses in ferro- and ferrimagnetic materials based on the modified Steinmetz equation", in *Proceedings of 34th Annual Meeting of the IEEE Industry Applications Society*, 1999, pp. 2087–92 vol.3.
- [2] Marian K. Kazimierczuk "High frequency magnetic components" John Wiley & Sons, 2009
- [3] P. L. Dowell, "Effects of eddy currents in transformer windings", *Proceedings of the IEE*, vol. 113, no. 8, pp. 1387–1394, Aug. 1966.
- [4] Pyrhönen, T. Jokinen, V. Hrabovcova, "Design of rotating electrical machines" John Wiley & Sons 2008
- [5] G. Swift, T. S. Molinski, and W. Lehn, "A fundamental approach to Transformer thermal modeling, part I—theory and equivalent circuit", *IEEE Trans. Power Delivery*, Vol. 16, pp. 171–175, 2001.
- [6] S. A. Ryder, "A simple method for calculating winding temperature gradient in power transformers," *IEEE Trans. Power Delivery*, vol. 17, pp. 977–982, Oct. 2002.
- [7] M. Rossi, G. Parent, M. Hecquet, V. Lanfranchi and M. Bekemans, "Thermal modeling of industrial inductors and transformers associated to the converters", *Proceedings of ICEM 2010*, Italy, Sept. 2010.
- [8] G. Parent, M. Rossi, M. Hecquet, V. Lanfranchi, M. Bekemans, "Multi-physics modeling of industrial inductors associated to converters", *IEEE Vehicle Power and Propulsion Conference - VPPC10 - Lille - FRANCE*, 9-2010.
- [9] K. Deb, A. Pratap, S. Agarwal, and T. Meyarivan, "A fast and elitist multiobjective genetic algorithm: NSGA-II," *IEEE Trans. Evol. Comput.*, vol. 6, pp. 182–197, Apr. 2002.
- [10] M. Rossi, M. Hecquet, V. Lanfranchi, J. Bou Sadaa, B. Lefebvre "Multiphysic Design Rules Applied To Inductors Or Transformers For Railway Application.", *International Electric Machines and Drives Conference – IEMDC2011*