



HAL
open science

Static and Dynamic Behaviors of Microstructured Membranes within Nonlocal Mechanics

Benjamin Hérissou, Noël Challamel, Vincent Picandet, Arnaud Perrot, C. M. Wang

► **To cite this version:**

Benjamin Hérissou, Noël Challamel, Vincent Picandet, Arnaud Perrot, C. M. Wang. Static and Dynamic Behaviors of Microstructured Membranes within Nonlocal Mechanics. *Journal of Engineering Mechanics - ASCE*, 2018, 144 (1), 10.1061/(ASCE)EM.1943-7889.0001379 . hal-01693902

HAL Id: hal-01693902

<https://hal.science/hal-01693902>

Submitted on 31 Dec 2019

HAL is a multi-disciplinary open access archive for the deposit and dissemination of scientific research documents, whether they are published or not. The documents may come from teaching and research institutions in France or abroad, or from public or private research centers.

L'archive ouverte pluridisciplinaire **HAL**, est destinée au dépôt et à la diffusion de documents scientifiques de niveau recherche, publiés ou non, émanant des établissements d'enseignement et de recherche français ou étrangers, des laboratoires publics ou privés.

Static and Dynamic Behaviors of Microstructured Membranes within Nonlocal Mechanics

B. Hérissou¹; N. Challamel²; V. Picandet³; A. Perrot⁴; and C. M. Wang⁵

Abstract: In this paper, the static and dynamic behaviors of a finite microstructured rectangular membrane were studied. The microstructured membrane model comprised an equal number of elastic springs in both directions forming a rectangular lattice membrane. The authors considered the out-of-plane displacement of each node of this two-dimensional lattice. The rectangular lattice membrane was fixed at its boundary. A nonlocal continuous membrane model was developed to approximate the behavior of the finite lattice model. A continualization procedure was applied to the discrete equations in which the difference operators were approximated by differential operators. The resulting nonlocal continuum was governed by some length scales in each direction that depended on the size of the microstructure. This nonlocal continuum exactly coincided with the one elaborated by Rosenau in the 1980s in the dynamics range. The authors showed that such a nonlocal medium also can be used for static deflection of microstructured membranes. A comparison of both discrete (the reference lattice model) and continualized nonlocal responses brought out the effectiveness of this micromechanics-based approach. The continualized nonlocal continuum also was compared with a phenomenological Eringen's nonlocal model.

Author keywords: Membrane; Continualization; Microstructure; Two-dimensional (2D) lattice; Nonlocal medium.

Introduction

The static and dynamic deflections of a lattice membrane were studied in this paper using both discrete and nonlocal continuum mechanics. This discrete membrane takes the form of a lattice, comprising elastic springs connected in both directions, forming a so-called microstructured rectangular membrane. The equivalent one-dimensional (1D) problem is the string, first studied by Lagrange (1759), who already showed the link between one-dimensional lattices with the associated continuum. Lagrange (1759) solved exactly the eigenfrequency problem of a fixed-fixed lattice string composed of any finite number of concentrated masses. Many research studies since were conducted on this problem with concentrated microstructure and, recent works, such as

Challamel et al. (2016c), showed the dependence of one-dimensional enriched continuum models to the microstructural patterns, including concentrated or distributed microstructures. This paper generalized this one-dimensional analysis to a two-dimensional (2D) microstructured membrane problem. The geometric and mechanical analysis of the microstructured membrane problem was on the basis of the work of Rosenau (1987) for transverse vibrations of a 2D lattice, although the discrete equations were linearized in this case. For the static part of this study, an evenly distributed pressure was applied on the lattice, which controlled the out-of-plane deflection.

The aim of this paper was to bridge discrete membrane mechanics and continuous membrane mechanics for both statics and dynamics problems. In this paper, the authors presented some new exact analytical solutions for both static and dynamic behaviors of finite lattice membranes with fixed edges. A continualized nonlocal model on the basis of the discrete difference equations of the lattice membrane also was developed. Such a process is called a continualization procedure, which was developed earlier by Kruskal and Zabusky (1964), for approximating nonlinear elastic axial lattices by enriched continuum models. Kruskal and Zabusky (1964) primarily expanded the difference operators in the lattice equations using Taylor-based asymptotic methods, leading to higher-order differential operators. It also is possible to use Padé's approximant of the pseudodifferential operator to avoid higher-order differential equations, as shown by Rosenau (1986), Wattis (2000), or Kevrekidis et al. (2002). Rosenau (1987) applied both methods (Taylor-based expansion and rational expansion) for approximating the vibration equations of the lattice membrane by a nonlocal continualized membrane, and then analytically derived some nonlocal dispersive wave equations that accounted for microstructured effects. This wave propagation problem in a lattice membrane also was investigated recently by Andrianov and Awrejcewicz (2008), who used one-point and two-point Padé approximants for calibrating the nonlocal membrane model. Lombardo and Askes (2010) approximated the lattice membrane by a nonlocal membrane model via Padé approximants, and solved the eigenfrequency problem

¹Ph.D. Student, FRE CNRS 3744 Institut de Recherche Dupuy de Lôme, Centre de Recherche, Université de Bretagne Sud, Rue de Saint Maudé, BP 92116, 56321 Lorient, France. E-mail: benjamin.herisson@univ-ubs.fr

²Professor, FRE CNRS 3744 Institut de Recherche Dupuy de Lôme, Centre de Recherche, Université de Bretagne Sud, Rue de Saint Maudé, BP 92116, 56321 Lorient, France (corresponding author). E-mail: noel.challamel@univ-ubs.fr

³Associate Professor, FRE CNRS 3744 Institut de Recherche Dupuy de Lôme, Centre de Recherche, Université de Bretagne Sud, Rue de Saint Maudé, BP 92116, 56321 Lorient, France. E-mail: vincent.picandet@univ-ubs.fr

⁴Associate Professor, FRE CNRS 3744 Institut de Recherche Dupuy de Lôme, Centre de Recherche, Université de Bretagne Sud, Rue de Saint Maudé, BP 92116, 56321 Lorient, France. E-mail: arnaud.perrot@univ-ubs.fr

⁵TMR Chair Professor in Structural Engineering, School of Civil Engineering, Univ. of Queensland, St Lucia, Queensland 4072, Australia. E-mail: cm.wang@uq.edu.au

for a fixed-fixed nonlocal membrane by a finite-element method. This problem was revisited in this paper, and features the derivation of analytical solutions. A mathematically similar problem was solved by Mindlin (1970) for three-dimensional (3D) lattice elasticity solutions with direct and indirect neighboring interactions, leading to similar linear second-order difference eigenvalue problems, although Mindlin did not specifically focus on the lattice membrane. Tong et al. (1971) obtained the exact eigenfrequency equation of the finite difference membrane problem, which is equivalent to the lattice problem considered in this paper. From a mathematical point-of-view, this problem is not so far from the diffusion problem (thermal conduction) in a 2D lattice media, which also is governed by a linear second-order spatial difference equation Challamel et al. (2016a). The lattice membrane problem is governed by a linear second-order difference equation, as opposed to the lattice plate model that is governed by a linear fourth-order difference equation (Challamel et al. 2016b; Zhang et al. 2015, 2014). The present work generalized the results initially developed by Rosenau (1987) for infinite membranes to finite size membranes and also included the static behavior of these microstructured membranes. In this paper, the authors present local and nonlocal models that were compared with the reference discrete lattice model to show that the nonlocality source in nonlocal membrane problems may come from the discreteness of the matter at a smaller scale.

Static Deflection of Lattice Membrane

The discrete membrane considered was composed of connected concentrated masses loaded by some vertical concentrated loads, qa^2 , for the interior nodes in the direction orthogonal to the membrane plane (q has the dimension of a load by unit surface, and a

defines the size of each membrane cell). All nodes of the membrane had only one degree of freedom in the vertical direction denoted by w , its out-of-plane deflection, and the rectangular membrane was fixed at its boundary. The rectangular membrane was composed of n_x springs of length a in the x direction, and n_y springs of the same length in the y direction. The distributed tension applied to the side of the membrane was denoted by T , as shown in Fig. 1. The length in each direction is noted, $L_x = L$, $L_y = \lambda L$, and the number of elements in each direction, $n_x = n$, $n_y = \lambda n$, in which λ is the aspect ratio. Fig. 2 shows a visualization of the membrane deflection for a value of $\lambda = 0.5$. The tensile load T was applied in the deformed configuration. The linearized static and dynamic equations of motion were investigated for this lattice rectilinear membrane. The vertical component of the force in each spring was calculated from the tensile load T as

$$\begin{aligned} P_{i+1/2,j}^x &= T \frac{w_{i+1,j} - w_{i,j}}{a} & P_{i-1/2,j}^x &= T \frac{w_{i,j} - w_{i-1,j}}{a} \\ P_{i,j+1/2}^y &= T \frac{w_{i,j+1} - w_{i,j}}{a} & P_{i,j-1/2}^y &= T \frac{w_{i,j} - w_{i,j-1}}{a} \end{aligned} \quad \text{and} \quad (1)$$

The equilibrium equation at each node may be written as

$$P_{i+1/2,j}^x - P_{i-1/2,j}^x + P_{i,j+1/2}^y - P_{i,j-1/2}^y = -qa \quad (2)$$

in which the transverse distributed load q has the dimension of a load by unit surface. By using Eqs. (1) and (2), one obtains the following linear second-order difference equation

$$T \left(\frac{w_{i+1,j} - 2w_{i,j} + w_{i-1,j}}{a^2} + \frac{w_{i,j+1} - 2w_{i,j} + w_{i,j-1}}{a^2} \right) = -q \quad (3)$$

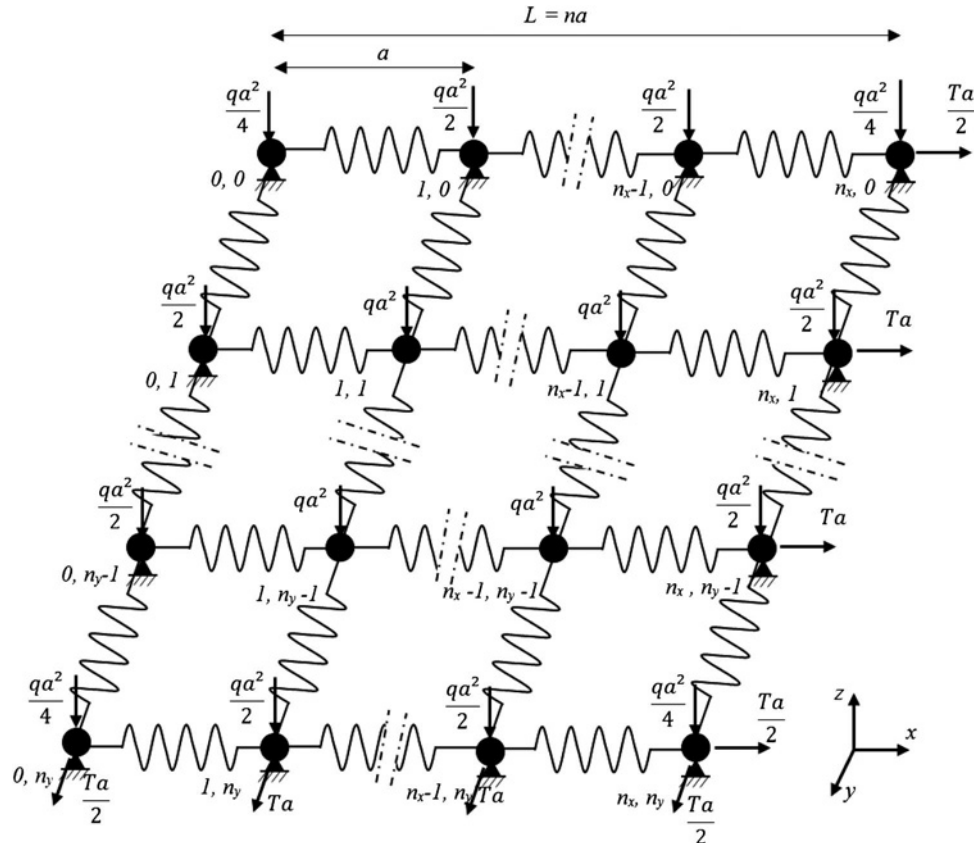

Fig. 1. Discrete membrane with uniform out-of-plane pressure

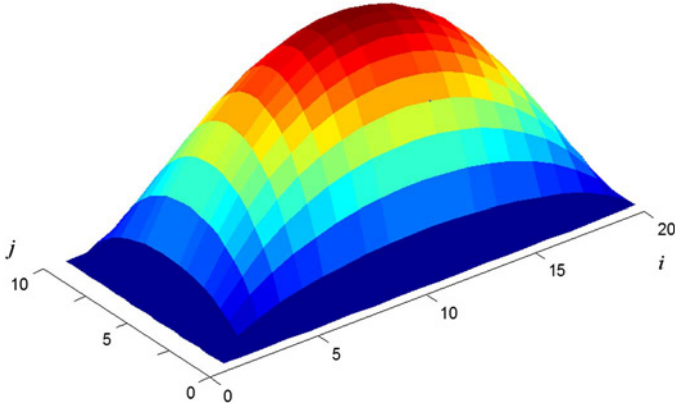

Fig. 2. Representation of membrane deflection of 2D lattice with $n = 20$ and $\lambda = 0.5$

The boundary conditions of the fixed-fixed lattice membrane are

$$\begin{aligned} w_{0,j} = w_{n_x,j} = 0 \quad \text{for } j \in \{0; 1 \dots; n_y\} \quad \text{and} \\ w_{i,0} = w_{i,n_y} = 0 \quad \text{for } i \in \{0; 1 \dots; n_x\} \end{aligned} \quad (4)$$

The difference equation of the lattice membrane problem is the finite difference formulation of the local continuous membrane problem, given by the Poisson type of partial differential equation

$$T\Delta w = -q \quad \text{with} \quad \Delta = \partial_x^2 + \partial_y^2 \quad (5)$$

Indeed, Eq. (1) also can be reformulated by using a central finite difference operator

$$\begin{aligned} P_{i,j}^x &= T \frac{w_{i+1/2,j} - w_{i-1/2,j}}{a} \\ P_{i,j}^y &= T \frac{w_{i,j+1/2} - w_{i,j-1/2}}{a} \end{aligned} \quad (6)$$

which is the central finite difference scheme of the continuous gradient law

$$\underline{P} = T\nabla w \quad \text{with} \quad \underline{P} = \begin{pmatrix} P_x \\ P_y \end{pmatrix} \quad \text{and} \quad \nabla = \begin{pmatrix} \partial_x \\ \partial_y \end{pmatrix} \quad (7)$$

Eq. (2) also can be reformulated as

$$\frac{P_{i+1/2,j}^x - P_{i-1/2,j}^x}{a} + \frac{P_{i,j+1/2}^y - P_{i,j-1/2}^y}{a} = -q \quad (8)$$

which is the central finite difference scheme associated to the equilibrium equation

$$\nabla \cdot \underline{P} = -q \quad \text{with} \quad \underline{P} = \begin{pmatrix} P_x \\ P_y \end{pmatrix} \quad \text{and} \quad \nabla = \begin{pmatrix} \partial_x \\ \partial_y \end{pmatrix} \quad (9)$$

By introducing a dimensionless loading parameter β , Eq. (3) becomes

$$\begin{aligned} \frac{w_{i+1,j} - 4w_{i,j} + w_{i-1,j} + w_{i,j+1} + w_{i,j-1}}{L} \\ = -\frac{qL}{Tn^2} = -\frac{\beta}{n^2} \quad \text{with} \quad \frac{qL}{T} = \beta \quad \text{and} \quad a = \frac{L}{n} \end{aligned} \quad (10)$$

This is a linear 2D second-order difference equation that can be solved numerically and exactly. The exact solution relies on the use of the double Fourier sine series, i.e.

$$\begin{aligned} T \frac{w_{i,j+1} + w_{i+1,j} + w_{i-1,j} + w_{i,j-1} - 4w_{i,j}}{a^2} \\ = -q = -q \sum_{m=1}^{\infty} \sum_{p=1}^{\infty} A_{m,p} \sin \frac{m\pi ai}{L} \sin \frac{p\pi aj}{\lambda L} \end{aligned} \quad (11)$$

The constant $A_{m,p}$ is then established as

$$A_{m,p} = \frac{4}{\lambda L^2} \int_0^L \int_0^{\lambda L} \sin \frac{m\pi x}{L} \sin \frac{p\pi y}{\lambda L} dx dy = \frac{16 \sin^2 \frac{m\pi}{2} \sin^2 \frac{p\pi}{2}}{\pi^2 mp} \quad (12)$$

By assuming that the deflection can be developed in Fourier series, one obtains

$$w_{i,j} = \sum_{m=1}^{\infty} \sum_{p=1}^{\infty} W_{m,p} \sin \frac{m\pi ai}{L} \sin \frac{p\pi aj}{\lambda L} \quad (13)$$

The substitution of Eq. (13) into Eq. (11) furnishes

$$\begin{aligned} \sum_{m=1}^{\infty} \sum_{p=1}^{\infty} \left[-\frac{4T}{a^2} W_{m,p} \left(\sin^2 \frac{m\pi a}{2L} + \sin^2 \frac{p\pi a}{2\lambda L} \right) \right. \\ \left. + \frac{16q \sin^2 \frac{m\pi}{2} \sin^2 \frac{p\pi}{2}}{\pi^2 mp} \right] \sin \frac{m\pi ai}{L} \sin \frac{p\pi aj}{\lambda L} = 0 \end{aligned} \quad (14)$$

There are two cases for identifying $W_{m,p}$

$$\begin{aligned} \sin \left(\frac{m\pi}{2n} \right) \neq 0 \quad \text{or} \quad \sin \left(\frac{p\pi}{2\lambda n} \right) \neq 0 \\ \Rightarrow W_{m,p} = \frac{4qa^2}{\pi^2 T} \frac{\sin^2 \frac{m\pi}{2} \sin^2 \frac{p\pi}{2}}{mp \left(\sin^2 \frac{m\pi a}{2L} + \sin^2 \frac{p\pi a}{2\lambda L} \right)} \end{aligned} \quad (15)$$

or

$$\sin \left(\frac{m\pi}{2n} \right) = \sin \left(\frac{p\pi}{2\lambda n} \right) = 0 \Rightarrow W_{m,p} = 0 \quad (16)$$

The substitution of Eq. (15) into Eq. (14) leads to

$$w_{i,j} = \frac{4qa^2}{\pi^2 T} \sum_{m=1}^{\infty} \sum_{p=1}^{\infty} \frac{\sin^2 \frac{m\pi}{2} \sin^2 \frac{p\pi}{2}}{mp \left(\sin^2 \frac{m\pi a}{2L} + \sin^2 \frac{p\pi a}{2\lambda L} \right)} \sin \frac{m\pi ai}{L} \sin \frac{p\pi aj}{\lambda L} \quad (17)$$

Eq. (17) is valid for all m and p , except for $(m = k_1 2n) \wedge (p = k_2 2\lambda n)$, in which k_1 and k_2 are positive integers, given by Eqs. (15) and (16). Of course, an exact solution in the form of an infinite summation always needs to be truncated when computed. For example, with $n = 16$, and truncating the expression after the first 500 terms, a solution was obtained that is close to the recursive exact solution within 0.5% margin of error. This can be presented in a dimensionless formulation with the same conditions on m and p as

$$w_{i,j}^* = \frac{4\beta}{\pi^2 n^2} \sum_{m=1}^{\infty} \sum_{p=1}^{\infty} \frac{\sin^2 \frac{m\pi}{2} \sin^2 \frac{p\pi}{2}}{mp \left(\sin^2 \frac{m\pi}{2n} + \sin^2 \frac{p\pi}{2\lambda n} \right)} \sin \frac{m\pi i}{n} \sin \frac{p\pi j}{\lambda n} \quad (18)$$

where $w^* = w/L$.

Static Deflection of Nonlocal Continuous Membrane

Nonlocal Continualized Membrane Model

To obtain a nonlocal approximation of the discrete system, a continualization procedure is applied on the discrete equations

$$w_{i+1,j} = \sum_{k=0}^{\infty} \frac{a^k \partial_x^k}{k!} w(x, y) = e^{a\partial_x} w(x, y) \quad (19)$$

When Eq. (19) is applied to the difference formulation of the lattice structural problem, one obtains

$$\begin{aligned} & \frac{w_{i+1,j} - 2w_{i,j} + w_{i-1,j}}{a^2} + \frac{w_{i,j+1} - 2w_{i,j} + w_{i,j-1}}{a^2} \\ &= \left(\frac{e^{a\partial_x} - 2 + e^{-a\partial_x}}{a^2} + \frac{e^{a\partial_y} - 2 + e^{-a\partial_y}}{a^2} \right) w \\ &= \left[\frac{2 \cosh(a\partial_x) - 4 + 2 \cosh(a\partial_y)}{a^2} \right] w \end{aligned} \quad (20)$$

The governing difference Eq. (3) becomes

$$\frac{-q}{T} = \left[\frac{4}{a^2} \sinh^2\left(\frac{a}{2}\partial_x\right) + \frac{4}{a^2} \sinh^2\left(\frac{a}{2}\partial_y\right) \right] w \quad (21)$$

By using the Padé's approximant of a second-order development of Eq. (21), one obtains

$$\frac{-q}{T} = \left[\frac{\partial_x^2}{1 - \frac{a^2}{12}\partial_x^2} + \frac{\partial_y^2}{1 - \frac{a^2}{12}\partial_y^2} \right] w \quad (22)$$

which may be rewritten as

$$-\left(1 - \frac{a^2}{12}\partial_x^2\right)\left(1 - \frac{a^2}{12}\partial_y^2\right)\frac{q}{T} = \left(\partial_x^2 + \partial_y^2 - \frac{a^2}{6}\partial_x^2\partial_y^2\right)w \quad (23)$$

By using the Laplacian operator and by neglecting higher-order terms in a^4 , Eq. (23) may be expressed as

$$T\left(\Delta - \frac{a^2}{6}\partial_x^2\partial_y^2\right)w = -\left(1 - \frac{a^2}{12}\Delta + O(a^4)\right)q \quad (24)$$

By omitting the higher-order terms in a^4 , the equation of the continualized nonlocal membrane becomes

$$\Delta w - \frac{a^2}{6}\left(\frac{\partial^4 w}{\partial x^2 \partial y^2}\right) = -\frac{1}{T}\left(1 - \frac{a^2}{12}\Delta\right)q \quad (25)$$

The governing second-order difference equation Eq. (3) was continualized directly. If one now considers the continualization of each first-order difference Eq. (6), one obtains

$$\begin{aligned} \left(1 - \frac{a^2}{24}\partial_x^2\right)P_x &= T\partial_x w \\ \left(1 - \frac{a^2}{24}\partial_y^2\right)P_y &= T\partial_y w \end{aligned} \quad (26)$$

whereas for Eq. (8), one obtains the continualized nonlocal equation

$$\partial_x\left(1 - \frac{a^2}{24}\partial_y^2\right)P_x + \partial_y\left(1 - \frac{a^2}{24}\partial_x^2\right)P_y = -\left(1 - \frac{a^2}{24}\Delta\right)q \quad (27)$$

By multiplying Eq. (27) with the partial differential operator $(1 - a^2/24\partial_y^2)(1 - a^2/24\partial_x^2)$, Eq. (27) also can be re-expressed as

$$\begin{aligned} & \left(1 - \frac{a^2}{12}\partial_y^2\right)\partial_x\left(1 - \frac{a^2}{24}\partial_x^2\right)P_x + \left(1 - \frac{a^2}{12}\partial_x^2\right)\partial_y\left(1 - \frac{a^2}{24}\partial_y^2\right)P_y \\ &= -\left(1 - \frac{a^2}{12}\Delta\right)q \end{aligned} \quad (28)$$

after the omission of higher-order terms. Eq. (28) can be equivalently written as

$$T\left(1 - \frac{a^2}{12}\partial_y^2\right)\partial_x^2 w + T\left(1 - \frac{a^2}{12}\partial_x^2\right)\partial_y^2 w = -\left(1 - \frac{a^2}{12}\Delta\right)q \quad (29)$$

One recognizes the continualized nonlocal membrane Eq. (25) from Eq. (29).

The authors looked for the static deflection solution of the continualized nonlocal membrane with fixed-fixed boundary conditions. Bearing in mind that, in this case, the vertical load was uniform, so $\Delta q = 0$; $A_{m,p}$ does not change in this case [Eq. (12)]. The Fourier series coefficient becomes

$$\begin{aligned} \Delta w - \frac{a^2}{6}\left(\frac{\partial^4 w}{\partial x^2 \partial y^2}\right) &= \sum_{m=1}^{\infty} \sum_{p=1}^{\infty} -C_{m,p} \left(\frac{m^2 \pi^2}{L^2} + \frac{p^2 \pi^2}{(\lambda L)^2} + \frac{a^2 m^2 p^2 \pi^4}{6\lambda^2 L^4}\right) \sin \frac{m\pi x}{L} \sin \frac{p\pi y}{\lambda L} \end{aligned} \quad (30)$$

Following the same process as in Eq. (14), this gives the expression of $C_{m,p}$

$$C_{m,p} = 16 \frac{qL^2}{T\pi^4} \sum_{m=1}^{\infty} \sum_{p=1}^{\infty} \frac{\sin^2 \frac{m\pi}{2} \sin^2 \frac{p\pi}{2}}{\left[m^2 + \left(\frac{p}{\lambda}\right)^2 + \frac{a^2 m^2 p^2 \pi^2}{6(\lambda L)^2}\right] mp} \quad (31)$$

The expression of the deflection for the nonlocal problem is therefore

$$\begin{aligned} w(x, y) &= 16 \frac{qL^2}{T\pi^4} \sum_{m=1}^{\infty} \sum_{p=1}^{\infty} \frac{\sin^2 \frac{m\pi}{2} \sin^2 \frac{p\pi}{2}}{\left[m^2 + \left(\frac{p}{\lambda}\right)^2 + \frac{a^2 m^2 p^2 \pi^2}{6(\lambda L)^2}\right] mp} \\ &\quad \times \sin \frac{m\pi x}{L} \sin \frac{p\pi y}{\lambda L} \end{aligned} \quad (32)$$

By using dimensionless variables, Eq. (32) can be expressed as

$$\begin{aligned} w^*(x^*, y^*) &= 16 \frac{\beta}{\pi^4} \sum_{m=1}^{\infty} \sum_{p=1}^{\infty} \frac{\sin^2 \frac{m\pi}{2} \sin^2 \frac{p\pi}{2}}{\left[m^2 + \left(\frac{p}{\lambda}\right)^2 + \frac{m^2 p^2 \pi^2}{6(\lambda n)^2}\right] mp} \\ &\quad \times \sin m\pi x^* \sin p\pi y^* \end{aligned} \quad (33)$$

A specific case in which $a = 0$ in Eq. (25), also can be studied for comparison (local membrane problem)

$$\begin{aligned} \frac{w_{i+1,j} - w_{i,j} + w_{i-1,j}}{a^2} &= \frac{\partial^2 w}{\partial x^2} + o(a^2) \\ \frac{w_{i,j+1} - w_{i,j} + w_{i,j-1}}{a^2} &= \frac{\partial^2 w}{\partial y^2} + o(a^2) \end{aligned} \quad (34)$$

The local problem at hand was governed by the Poisson-type partial differential equation

$$\frac{\partial^2 w}{\partial x^2} + \frac{\partial^2 w}{\partial y^2} = \Delta w = -\frac{q}{T} \quad (35)$$

An analytical solution to this problem can be found using the double Fourier series because the deflection on the side of the membrane cancelled out according to the boundary conditions. The solution can be written as

$$w(x, y) = \sum_{m=1}^{\infty} \sum_{p=1}^{\infty} C_{m,p} \sin \frac{m\pi x}{L} \sin \frac{p\pi y}{\lambda L} \quad (36)$$

in which $C_{m,p}$ is a constant obtained by calculating the Laplacian of this solution

$$\Delta w = \sum_{m=1}^{\infty} \sum_{p=1}^{\infty} -C_{m,p} \left[\frac{m^2 \pi^2}{L^2} + \frac{p^2 \pi^2}{(\lambda L)^2} \right] \sin \frac{m\pi x}{L} \sin \frac{p\pi y}{\lambda L} \quad (37)$$

From Eq. (35), one can write

$$\nabla^2 w = \frac{-q}{T} = \sum_{m=1}^{\infty} \sum_{p=1}^{\infty} A_{m,p} \sin \frac{m\pi x}{L} \sin \frac{p\pi y}{\lambda L} \quad (38)$$

and $A_{m,p}$ is then calculated as

$$\begin{aligned} A_{m,p} &= \frac{4}{\lambda L^2} \int_0^L \int_0^{\lambda L} -\frac{q}{T} \sin \frac{m\pi x}{L} \sin \frac{p\pi y}{\lambda L} dx dy \\ &= -\frac{16q \sin^2 \frac{m\pi}{2} \sin^2 \frac{p\pi}{2}}{mp T \pi^2} \end{aligned} \quad (39)$$

By observation, it can be deduced the value of $C_{m,p}$ is given by

$$\begin{aligned} -C_{m,p} \frac{\pi^2}{L^2} \left[m^2 + \left(\frac{p}{\lambda} \right)^2 \right] &= A_{m,p} \\ \Rightarrow C_{m,p} &= 16 \frac{q L^2}{T \pi^4} \frac{\sin^2 \frac{m\pi}{2} \sin^2 \frac{p\pi}{2}}{\left[m^2 + \left(\frac{p}{\lambda} \right)^2 \right] mp} \end{aligned} \quad (40)$$

The expression of the solution in Eq. (36) therefore becomes

$$w(x, y) = 16 \frac{q L^2}{T \pi^4} \sum_{m=1}^{\infty} \sum_{p=1}^{\infty} \frac{\sin^2 \frac{m\pi}{2} \sin^2 \frac{p\pi}{2}}{\left[m^2 + \left(\frac{p}{\lambda} \right)^2 \right] mp} \sin \frac{m\pi x}{L} \sin \frac{p\pi y}{\lambda L} \quad (41)$$

which can be presented in dimensionless terms as

$$w(x^*, y^*)^* = 16 \frac{\beta}{\pi^4} \sum_{m=1}^{\infty} \sum_{p=1}^{\infty} \frac{\sin^2 \frac{m\pi}{2} \sin^2 \frac{p\pi}{2}}{\left[m^2 + \left(\frac{p}{\lambda} \right)^2 \right] mp} \sin m\pi x^* \sin p\pi y^* \quad (42)$$

where $x^* = \frac{x}{L}$; and $y^* = y/\lambda L$.

Eringen's Type Nonlocal Membrane Model

The derived continualized nonlocal model can be compared with another phenomenological nonlocality, namely a nonlocal model on the basis of Eringen's differential law Eringen (1983) for the differential relation between the stress and the strain variables. A vectorial formulation can be defined as

$$\begin{aligned} \underline{P} - l_c^2 \nabla^2 \underline{P} &= T \nabla w \quad \text{and} \quad \nabla \cdot \underline{P} = -q \quad \text{with} \\ \underline{P} &= \begin{pmatrix} P_x \\ P_y \end{pmatrix} \quad \text{and} \quad \nabla = \begin{pmatrix} \partial_x \\ \partial_y \end{pmatrix} \end{aligned} \quad (43)$$

where $\nabla^2 = \Delta$; $\nabla =$ gradient operator; and $\underline{P} =$ vertical force vector calculated for each direction of the plane. Eq. (43) also can be written as

$$\begin{aligned} P_x - l_c^2 \left(\frac{\partial^2 P_x}{\partial x^2} + \frac{\partial^2 P_x}{\partial y^2} \right) &= T \frac{\partial w}{\partial x} \\ P_y - l_c^2 \left(\frac{\partial^2 P_y}{\partial x^2} + \frac{\partial^2 P_y}{\partial y^2} \right) &= T \frac{\partial w}{\partial y} \end{aligned} \quad \text{and} \quad \frac{\partial P_x}{\partial x} + \frac{\partial P_y}{\partial y} = -q \quad (44)$$

In the nonlocal membrane using Eringen's nonlocality, the latter appears as the Laplacian of the load, i.e.

$$T \Delta w = -[1 - l_c^2 \Delta] q \quad (45)$$

Eq. (45), when written in Cartesian coordinates, is given by

$$T \left(\frac{\partial^2 w}{\partial x^2} + \frac{\partial^2 w}{\partial y^2} \right) = -q + l_c^2 \left(\frac{\partial^2 q}{\partial x^2} + \frac{\partial^2 q}{\partial y^2} \right) \quad (46)$$

The same result can be obtained with a slight change in the vectorial formulation as such

$$\underline{P} - l_c^2 \nabla (\nabla \cdot \underline{P}) = T \nabla w \quad \text{and} \quad \nabla \cdot \underline{P} = -q \quad (47)$$

which can be written in Cartesian coordinates as

$$\begin{aligned} P_x - l_c^2 \left(\frac{\partial^2 P_x}{\partial x^2} + \frac{\partial^2 P_x}{\partial x \partial y} \right) &= T \frac{\partial w}{\partial x} \\ P_y - l_c^2 \left(\frac{\partial^2 P_x}{\partial x \partial y} + \frac{\partial^2 P_y}{\partial y^2} \right) &= T \frac{\partial w}{\partial y} \end{aligned} \quad \text{and} \quad \frac{\partial P_x}{\partial x} + \frac{\partial P_y}{\partial y} = -q \quad (48)$$

Both Eqs. (44) and (48) lead to Eq. (45) despite the slight difference in the formulation. In this case, this nonlocal problem was equivalent to the local membrane because the pressure applied to the membrane was constant. Fig. 3 presents the results of the different models with respect to the results of the discrete system for small values of n , with

$$\text{Err} = \frac{w(\frac{n}{2}, \frac{n}{2})_{\text{Discrete}} - w(\frac{1}{2}, \frac{1}{2})_{\text{Continuous}}}{w(\frac{n}{2}, \frac{n}{2})_{\text{Discrete}}} \quad (49)$$

Fig. 4 shows the normalized deflection of the center of the membrane. For Figs. 3 and 4, only even values of n were plotted because odd values did not present a central point on the membrane. The continualized nonlocal membrane model clearly offered the best accuracy with respect to the lattice solution.

Dynamics of Lattice Membrane

The vibration equations of the lattice membrane were obtained from Eq. (1), whereas the equilibrium [Eq. (2)] took into account the inertia terms

$$P_{i+1/2,j}^x - P_{i-1/2,j}^x + P_{i,j+1/2}^y - P_{i,j-1/2}^y = \rho a \ddot{w}_{i,j} \quad (50)$$

where $\rho =$ membrane density. In view of Eqs. (1) and (50), a linear second-order difference equation is obtained as

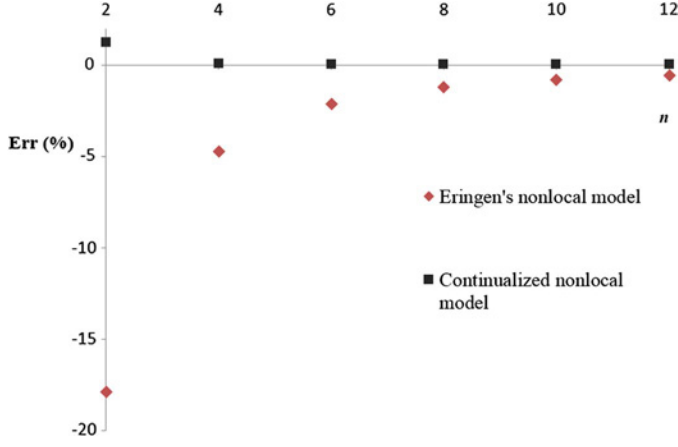

Fig. 3. Relative error of continualized and phenomenological Eringen's nonlocal models with respect to lattice response for different values of n —static response

$$T \frac{w_{i+1,j} + w_{i-1,j} + w_{i,j+1} + w_{i,j-1} - 4w_{i,j}}{a^2} = \rho \ddot{w}_{i,j} \quad (51)$$

The boundary conditions of the fixed-fixed lattice membrane are given by Eq. (4). As observed for the static problem, the difference equation of the lattice membrane problem was the spatial finite differences formulation of the local continuous membrane problem given by the following wave equation:

$$T \Delta w = \rho \ddot{w} \quad \text{with} \quad \Delta = \partial_x^2 + \partial_y^2 \quad (52)$$

The equation governing the behavior of the discrete membrane in dynamics is

$$T \frac{w_{i,j+1} + w_{i+1,j} + w_{i-1,j} + w_{i,j-1} - 4w_{i,j}}{a^2} + \rho \omega^2 w_{i,j} = 0 \quad (53)$$

where ω = angular frequency. Eq. (53) can be written in the form

$$T \frac{w_{i,j+1} + w_{i+1,j} + w_{i-1,j} + w_{i,j-1} + \left(\frac{a^2}{T} \rho \omega^2 - 4\right) w_{i,j}}{a^2} = 0 \quad (54)$$

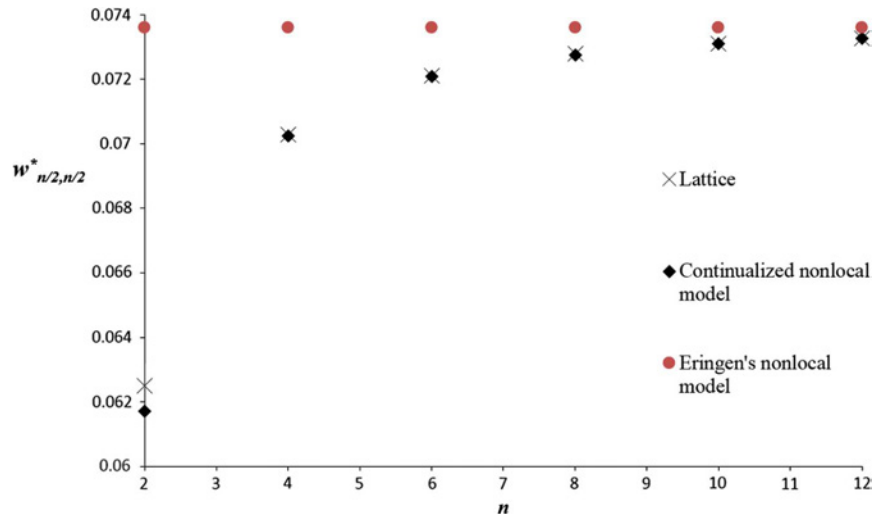

Fig. 4. Normalized deflection of center of square membrane for n elements in each direction

The linear 2D second-order difference eigenvalue problem to be solved is

$$w_{i,j+1} + w_{i+1,j} + w_{i-1,j} + w_{i,j-1} + \left(\frac{a^2}{T} \rho \omega^2 - 4\right) w_{i,j} = 0 \quad (55)$$

A solution can be found of $w_{i,j}$ in the form

$$w_{i,j} = W_{r,s} \sin \frac{r\pi a i}{L} \sin \frac{s\pi a j}{\lambda L} \quad (56)$$

By substituting Eq. (56) into Eq. (55), the natural frequencies of the discrete membrane can be extracted as

$$\omega_{r,s} = \sqrt{\frac{4T}{\rho a^2} \left(\sin^2 \frac{r\pi a}{2L} + \sin^2 \frac{s\pi a}{2\lambda L} \right)} \quad \text{with} \quad r \in \{1; 2; \dots; n_x\}$$

and $s \in \{1; 2; \dots; n_y\}$ (57)

Eq. (57) also was obtained by Tong et al. (1971) who solved the exact finite element formulation of the continuous membrane problem on the basis of a linear interpolation field for the displacement in the functional expressed with gradient variables, and a constant interpolation field for the kinetic energy functional. Such formulation may be labelled nonconsistent because the interpolation field may differ in the considered functionals. This formulation is equivalent to the finite difference formulation of the continuous membrane problem. Eq. (57) has been also obtained independently by Chen (1971) [see also Rutherford (1948) who derived the same result for a mathematical analogous problem]. The natural frequencies of the fixed-fixed lattice membrane is normalised by

$$\Omega_{r,s} = \sqrt{4n^2 \left(\sin^2 \frac{r\pi}{2n} + \sin^2 \frac{s\pi}{2\lambda n} \right)} \quad \text{with} \quad \Omega = \omega L \sqrt{\frac{\rho}{T}} \quad (58)$$

The lattice membrane can be compared with its local continuum counterpart, governed by the following partial differential equation:

$$T \nabla^2 w + \rho \omega^2 w = 0 \quad (59)$$

The exact solution of the local dynamic problem can be obtained from standard textbooks, such as Wang and Wang (2013)

or Leissa and Qatu (2011), for a fixed-fixed membrane considering the sinusoidal vibration mode

$$w(x, y) = \sin \frac{r\pi x}{L} \sin \frac{s\pi y}{\lambda L} \quad (60)$$

where $m, p =$ nonzero integers providing the number of half waves in the x, y directions, respectively. The natural frequencies of the membrane are given by

$$\omega_{r,s} = \frac{\pi}{L} \sqrt{\frac{T}{\rho} \left[r^2 + \left(\frac{s}{\lambda} \right)^2 \right]} \quad (61)$$

Again, the results are normalized, which gives

$$\Omega_{r,s} = \pi \sqrt{r^2 + \left(\frac{s}{\lambda} \right)^2} \quad (62)$$

This exact solution does not require infinite summation computing as in the static case. These results are consistent with Wang and Wang (2013) and Leissa and Qatu (2011) results for local rectangular membranes.

Dynamics of Nonlocal Continuous Membrane

Nonlocal Continualized Membrane Model

The continualized nonlocal lattice-based model was obtained by considering a similar reasoning to the one applied to the static case, i.e.,

$$T \left[\frac{4}{a^2} \sinh^2 \left(\frac{a}{2} \partial_x \right) + \frac{4}{a^2} \sinh^2 \left(\frac{a}{2} \partial_y \right) \right] w + \rho \omega^2 w = 0 \quad (63)$$

Using Eq. (19) on Eq. (55) as in the static case, the nonlocal approximation of the discrete membrane is obtained

$$T \Delta w - T \frac{a^2}{6} \frac{\partial^4 w}{\partial x^2 \partial y^2} + \rho \omega^2 \left(1 - \frac{a^2}{12} \Delta \right) w = 0 \quad (64)$$

This equation already was obtained by Rosenau (1987) from the same reasoning on the basis of the Padé approximant of the pseudodifferential operator. Eq. (64) may be written in the form as

$$\left(T - \rho \omega^2 \frac{a^2}{12} \right) \Delta w - T \frac{a^2}{6} \frac{\partial^4 w}{\partial x^2 \partial y^2} + \rho \omega^2 w = 0 \quad (65)$$

As in the local problem, the solution of the deflection is given by

$$w(x, y) = \sin \frac{r\pi x}{L} \sin \frac{s\pi y}{\lambda L} \quad (66)$$

By substituting Eq. (66) into Eq. (65), one obtains

$$\begin{aligned} & \left(T - \rho \omega^2 \frac{a^2}{12} \right) \Delta w - T \frac{a^2}{6} \frac{\partial^4 w}{\partial x^2 \partial y^2} + \rho \omega^2 w \\ &= - \left[\left(T - \rho \omega^2 \frac{a^2}{12} \right) \left(\frac{r^2 \pi^2}{L^2} + \frac{s^2 \pi^2}{(\lambda L)^2} \right) \right. \\ & \quad \left. + \frac{T a^2 r^2 s^2 \pi^4}{6 \lambda^2 L^4} - \rho \omega^2 \right] \sin \frac{r\pi x}{L} \sin \frac{s\pi y}{\lambda L} \end{aligned} \quad (67)$$

Finally, the natural frequencies of the nonlocal continuous membrane can be extracted as

$$\omega_{r,s} = \pi \sqrt{\frac{T \left[r^2 + s^2 + \frac{a^2 r^2 s^2 \pi^2}{6(\lambda L)^2} \right]}{\rho L^2 \left[1 + \frac{a^2}{12} \left(\frac{r^2 \pi^2}{L^2} + \frac{s^2 \pi^2}{(\lambda L)^2} \right) \right]}} \quad (68)$$

By using the normalisation, Eq. (68) becomes

$$\Omega_{r,s} = \pi \sqrt{\frac{r^2 + s^2 + \frac{r^2 s^2 \pi^2}{6(\lambda n)^2}}{1 + \frac{\pi^2}{12n^2} \left(r^2 + \frac{s^2}{\lambda} \right)}} \quad (69)$$

Eringen's Type Nonlocal Membrane Model

For comparison, the case of the Eringen's nonlocality for this membrane can be studied. Defining a vectorial formulation as

$$\begin{aligned} \underline{P} - l_c^2 \underline{\nabla}^2 \underline{P} &= T \underline{\nabla} w \quad \text{and} \quad \underline{\nabla} \cdot \underline{P} = -\rho \omega^2 w \quad \text{with} \\ \underline{P} &= \begin{pmatrix} P_x \\ P_y \end{pmatrix} \quad \text{and} \quad \underline{\nabla} = \begin{pmatrix} \partial_x \\ \partial_y \end{pmatrix} \end{aligned} \quad (70)$$

where $\underline{\nabla}^2 = \Delta \underline{1}$; $\underline{\nabla}$ = gradient operator; and \underline{P} = vertical force vector calculated for each direction of the plane. Eq. (70) also can be written as

$$\begin{aligned} P_x - l_c^2 \left(\frac{\partial^2 P_x}{\partial x^2} + \frac{\partial^2 P_x}{\partial y^2} \right) &= T \frac{\partial w}{\partial x} \quad \text{and} \quad \frac{\partial P_x}{\partial x} + \frac{\partial P_y}{\partial y} = -\rho \omega^2 w \\ P_y - l_c^2 \left(\frac{\partial^2 P_y}{\partial x^2} + \frac{\partial^2 P_y}{\partial y^2} \right) &= T \frac{\partial w}{\partial y} \end{aligned} \quad (71)$$

This continuous nonlocal, in the sense of the differential model of Eringen (1983), membrane is then defined as

$$T \Delta w + \rho \omega^2 \left(1 - \frac{a^2}{12} \Delta \right) w = 0 \quad (72)$$

Eq. (72) can be written in Cartesian coordinates as

$$\left(T - \rho \omega^2 \frac{a^2}{12} \right) \left(\frac{\partial^2 w}{\partial x^2} + \frac{\partial^2 w}{\partial y^2} \right) + \rho \omega^2 w = 0 \quad (73)$$

which previously was obtained by Rosenau (1987) as a simplified engineering nonlocal membrane model. The same comment, as in the static analysis, can be made regarding the alternative vectorial formulation

$$\underline{P} - l_c^2 \underline{\nabla} (\underline{\nabla} \cdot \underline{P}) = T \underline{\nabla} w \quad \text{and} \quad \underline{\nabla} \cdot \underline{P} = -\rho \omega^2 w \quad (74)$$

which similarly can be written in Cartesian coordinates as

$$\begin{aligned} P_x - l_c^2 \left(\frac{\partial^2 P_x}{\partial x^2} + \frac{\partial^2 P_x}{\partial x \partial y} \right) &= T \frac{\partial w}{\partial x} \quad \text{and} \quad \frac{\partial P_x}{\partial x} + \frac{\partial P_y}{\partial y} = -\rho \omega^2 w \\ P_y - l_c^2 \left(\frac{\partial^2 P_y}{\partial x \partial y} + \frac{\partial^2 P_y}{\partial y^2} \right) &= T \frac{\partial w}{\partial y} \end{aligned} \quad (75)$$

which also leads to Eq. (72). Again, the solution the authors looked for was in the form of Eq. (66). This allows one to obtain

$$\begin{aligned} & \left(T - \rho\omega^2 \frac{a^2}{12}\right)\Delta w + \rho\omega^2 w \\ & = - \left[\left(T - \rho\omega^2 \frac{a^2}{12}\right) \left(\frac{r^2\pi^2}{L^2} + \frac{s^2\pi^2}{(\lambda L)^2}\right) - \rho\omega^2 \right] \sin \frac{r\pi x}{L} \sin \frac{s\pi y}{\lambda L} \end{aligned} \quad (76)$$

Finally, the natural frequencies of the Eringen's nonlocal membrane are extracted as

$$\omega_{r,s} = \pi \sqrt{\frac{T(r^2 + \frac{s^2}{\lambda})}{\rho L^2 \left[1 + \frac{a^2}{12} \left(\frac{r^2\pi^2}{L^2} + \frac{s^2\pi^2}{(\lambda L)^2}\right)\right]}} \quad (77)$$

By using the normalisation, Eq. (77) becomes

$$\Omega_{r,s} = \pi \sqrt{\frac{\left(r^2 + \frac{s^2}{\lambda}\right)}{1 + \frac{\pi^2}{12n^2} \left(r^2 + \frac{s^2}{\lambda}\right)}} \quad (78)$$

One can observe that Eq. (65) can be presented as a mixed gradient [Eq. (72)] nonlocal vibration model by using the higher-order term of the membrane deflection. Fig. 5 presents the results of the different models with respect to the results of the discrete system for small values of n , with

$$\text{Err} = \frac{\Omega_{\text{Discrete}} - \Omega_{\text{continuous}}}{\Omega_{\text{Discrete}}} \quad (79)$$

Fig. 5 shows that local and Eringen's nonlocal models do not offer good results; the latter being the only one that gave a stiffer response than the discrete model. The nonlocal model with the coupled term presented the best results. Fig. 6 shows the normalized natural frequencies of the membrane for different values of n .

The nonlocal engineering membrane model of Rosenau (1987), who investigated a truncated form of the continualized nonlocal model (to be cast in an Eringen's differential form), is not sufficiently accurate, as compared with the complete nonlocal form, also derived by Rosenau (1987). In particular, for the static behavior of the uniformly loaded membrane, the truncated nonlocal model gave similar results as compared with the local membrane

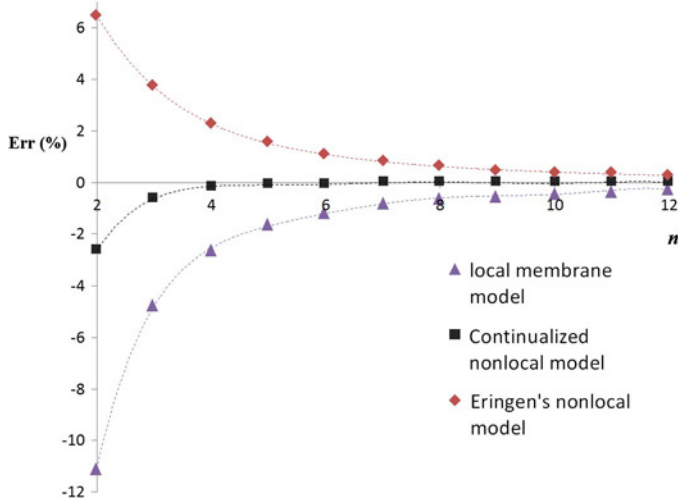

Fig. 5. Relative error of continualized and phenomenological Eringen's nonlocal models with respect to lattice response for different values of n —dynamic response

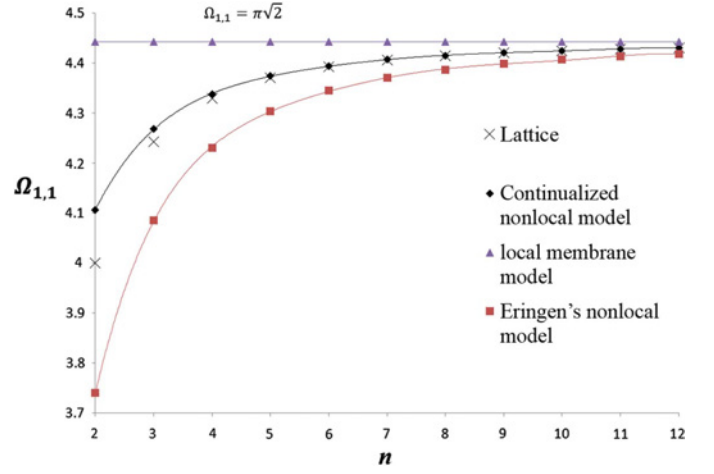

Fig. 6. Normalized natural frequencies Ω for $m = p = 1$ of square membrane ($\lambda = 1$) for n elements in each direction

model, which clearly was not accurate because the lattice membrane possessed scale effects even in the static range. Therefore, the use of the complete form of the nonlocal continualized model as derived by Rosenau in dynamics is recommended, and is extended to static loading as

$$T\Delta w - T \frac{a^2}{6} \frac{\partial^4 w}{\partial x^2 \partial y^2} = \left(1 - \frac{a^2}{12} \Delta\right) (\rho\ddot{w} - q) \quad (80)$$

High Frequency Behavior

For low frequency, Eq. (63) is approximated by Eq. (64) as already shown by Rosenau (1987) (Andrianov and Awrejcewicz 2008). For high-frequency range, Andrianov and Awrejcewicz (2008) suggested calibrating the nonlocal terms as

$$T\Delta w - \beta a^2 T \frac{\partial^4 w}{\partial x^2 \partial y^2} + \rho\omega^2 (1 - \alpha a^2 \Delta) w = 0 \quad (81)$$

where $\alpha = \frac{1}{4} - \frac{1}{\pi^2}$. For a one-dimensional system, this equation reduces to the nonlocal vibration of string (which is mathematically equivalent to the nonlocal vibration of elastic axial bars)

$$T \frac{\partial^2 w}{\partial x^2} + \rho\omega^2 \left[1 - (e_0 a)^2 \frac{\partial^2}{\partial x^2}\right] w = 0 \quad (82)$$

where $e_0 = \sqrt{\frac{1}{4} - \frac{1}{\pi^2}} \approx 0.386$. This last value, $e_0 \approx 0.39$, is indeed the value obtained by Eringen (1983) from the calibration of his nonlocal model with the wave dispersive relationship of Born-Kármán lattice model in the Brillouin zone. In Eq. (81), the parameters (α , β) were calibrated with respect to the highest frequency range. The lattice frequency in this frequency range was calculated from Eq. (58)

$$r = n \quad \text{and} \quad s = \lambda n \Rightarrow \Omega_{n,\lambda n} = 2\sqrt{2}n \quad (83)$$

If the sinusoidal displacement field Eq. (60) now is used and inserted in the nonlocal vibration equation Eq. (81), one obtains

$$r = n \quad \text{and} \quad s = \lambda n \Rightarrow \Omega_{n,\lambda n} = n\pi \sqrt{\frac{2 + \beta\pi^2}{1 + 2\alpha\pi^2}} \quad (84)$$

By equalizing Eqs. (83) and (84) with $\alpha = \frac{1}{4} - \frac{1}{\pi^2}$, one obtains

$$\beta = \frac{2}{\pi^2} - \frac{8}{\pi^4} \quad (85)$$

which is the value reported by Andrianov and Awrejcewicz (2008) for the wave propagation of the nonlocal membrane calibrated with respect to the lattice one in the high-frequency range.

The low-frequency and the high-frequency nonlocal models can be compared with the exact lattice model in the specific case $\Omega_{r,\lambda r}$ with respect to $r \in \{1; 2; \dots; n\}$. Eq. (58) is specified in this case as

$$\Omega_{r,\lambda r} = 2\sqrt{2}n \sin\left(\frac{r\pi}{2n}\right) \quad (86)$$

The nonlocal model valid for low frequencies on the basis of Eq. (64) gives

$$\Omega_{r,\lambda r} = k\pi \sqrt{\frac{2 + \frac{(r\pi)^2}{6n^2}}{1 + \frac{(r\pi)^2}{6n^2}}} \quad (87)$$

whereas, the nonlocal model valid for high frequencies is on the basis of Eq. (81), and is written

$$\Omega_{r,\lambda r} = r\pi \sqrt{\frac{2 + \beta \frac{(r\pi)^2}{n^2}}{1 + 2\alpha \frac{(r\pi)^2}{n^2}}} \quad (88)$$

where $\alpha = \frac{1}{4} - \frac{1}{\pi^2}$; and $\beta = \frac{2}{\pi^2} - \frac{8}{\pi^4}$.

Fig. 7 shows the evolution of the eigenfrequencies for the lattice model, the nonlocal model of Rosenau (1987) for low frequencies (see also Andrianov and Awrejcewicz 2008) and the one established by Andrianov and Awrejcewicz (2008) for high frequencies. The validity of each nonlocal model strongly depends on the frequency range considered, but both approximations, for low frequencies and high frequencies are relevant in their validity domain.

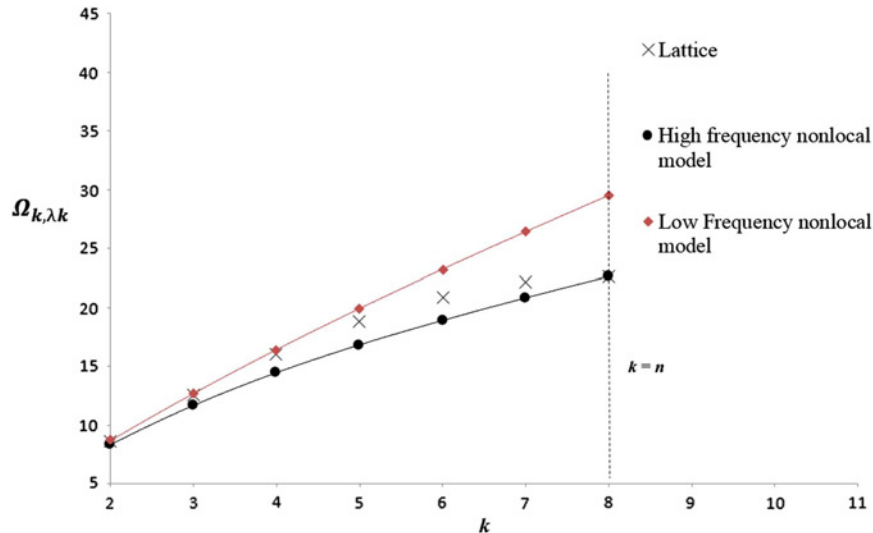

Fig. 7. Normalized natural frequencies Ω for $n = 8$ of rectangular membrane with respect to the mode number k

Wave Dispersion Analysis

In this section, the plane wave propagation in the 2D membrane lattice was studied and was compared with its nonlocal counterpart, especially in the so-called first Brillouin zone.

The dispersion equation can be obtained from the following harmonic wave formulation:

$$w_{i,j} = W \exp[J(\omega t - k_x x_i - k_y x_j)] \quad (89)$$

where ω = angular frequency; W = amplitude; $J = \sqrt{-1}$ = imaginary number; $x_i = ia$; and $y_j = ja$.

Introducing Eq. (89) in the 2D wave equation of the lattice membrane, Eq. (51), leads to the dispersion relation in the 2D lattice

$$\tilde{\omega}^2 = 4 \left[\sin^2\left(\frac{k_x a}{2}\right) + \sin^2\left(\frac{k_y a}{2}\right) \right] \quad \text{with} \quad \tilde{\omega} = \omega a \sqrt{\frac{\rho}{T}} \quad (90)$$

which was obtained by Rosenau (1987) and Lombardo and Askes (2010). As suggested by the latter, it is possible to introduce a direction angle that characterizes the wave vector orientation with respect to the horizontal axis

$$\begin{cases} k_x = k \cos \theta \\ k_y = k \sin \theta \end{cases} \quad (91)$$

so that the wave dispersion relation can be re-expressed by

$$\tilde{\omega} = \pm 2 \sqrt{\sin^2\left(\frac{ka \cos \theta}{2}\right) + \sin^2\left(\frac{ka \sin \theta}{2}\right)} \quad (92)$$

This wave dispersive relation can be compared with the one obtained for the wave propagation equation in the nonlocal membrane associated with Eq. (81)

$$T \Delta w - \beta a^2 T \frac{\partial^4 w}{\partial x^2 \partial y^2} - \rho(1 - \alpha a^2 \Delta) \ddot{w} = 0$$

with $\alpha = \frac{1}{4} - \frac{1}{\pi^2}$ and $\beta = \frac{2}{\pi^2} - \frac{8}{\pi^4}$ (93)

as previously obtained from the high-frequency calibration [see the parameters calibration of (Andrianov and Awrejcewicz 2008)].

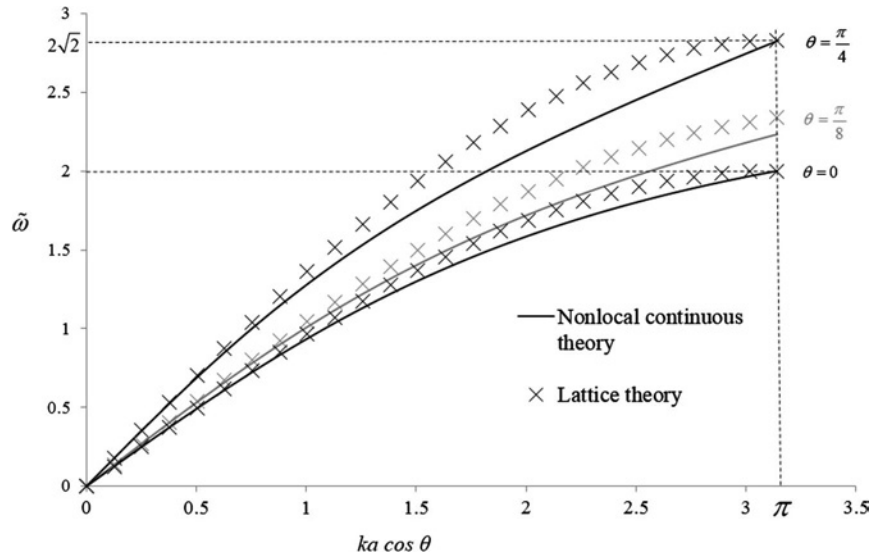

Fig. 8. Comparison of the lattice model with the nonlocal one in the first Brillouin zone for $ka \cos \theta \in [0, \pi]$ and $\theta \in \{0; \frac{\pi}{8}; \frac{\pi}{4}\}$

Now, considering the harmonic wave formulation in the nonlocal continuous membrane model

$$w = W \exp[J(\omega t - k_x x - k_y y)] \quad (94)$$

Introducing Eq. (94) in the nonlocal wave equation, Eq. (93), leads to the wave dispersive relationship

$$\tilde{\omega}^2 = \frac{(k_x a)^2 + (k_y a)^2 + \beta(k_x a)^2(k_y a)^2}{1 + \alpha[(k_x a)^2 + (k_y a)^2]} \quad (95)$$

which can be re-expressed using the polar representation

$$\tilde{\omega} = \pm ka \sqrt{\frac{1 + \frac{\beta}{4}(ka)^2 \sin^2(2\theta)}{1 + \alpha(ka)^2}} \quad (96)$$

This wave dispersive equation was obtained by Lombardo and Askes (2010), in which α and β were calibrated in the so-called low-frequency range. The comparison of the lattice model and the nonlocal one in the first Brillouin zone, i.e., for $ka \cos \theta \in [0, \pi]$ and $\theta \in \{0; \frac{\pi}{8}; \frac{\pi}{4}\}$, shows the efficiency of the nonlocal model in terms of wave dispersive properties on the basis of Eq. (93) with the so-called high-frequency calibration (Fig. 8).

The dispersive wave properties calibration of the 2D wave membrane problem in the present problem was similar to the one performed by Eringen (1983) for one-dimensional wave problems. Eringen (1983) obtained the same calibration for the α parameter, i.e., $\alpha = \frac{1}{4} - \frac{1}{\pi^2}$. The present nonlocal dispersive wave analysis generalized the results of (Eringen 1983) to the 2D lattice media, using the nonlocal calibration established by Andrianov and Awrejcewicz (2008).

Conclusions

The out-of-plane deflection and vibration of a 2D discrete membrane and the associated continualized models were studied in this paper. The results showed that a nonlocal continuous structure can behave as a microstructured lattice model, the former equations being derived from the discrete equations using a continualization procedure. Analytical solutions found for the different structural

membrane problems and numerical simulations confirmed the results on the basis of programming the algebraic problem. In comparison with an Eringen's type nonlocality, the fully coupled nonlocal model seemed to better fit the discrete response both in statics (in which it is equivalent to a local model) and in dynamics. The size of the microstructure of the rectangular membrane determined the characteristic length of the nonlocal model at the macroscopic scale. The authors found a nonlocal characteristic length that was load-independent and only on the basis of the size of the microstructure. The length scale was the same in statics and in dynamics for low-frequency range. However, for high-frequency range, the characteristic length could be fitted with respect to 2D lattice wave dispersive properties, which generalizes the results obtained by Eringen (1983) from the one-dimensional axial lattice with direct neighboring interaction. The generalization of the effectiveness of such nonlocal membrane model as compared with the lattice one probably should be confirmed for general end-supports boundary conditions. Also, the effect of the cell geometry, including hexagonal lattice, could be treated in a future study to cover more microstructural patterns.

References

- Andrianov, I. V., and Awrejcewicz, J. (2008). "Continuous models for 2D discrete media valid for higher-frequency domain." *Comput. Struct.*, 86(1–2), 140–144.
- Challamel, N., Grazide, C., Picandet, V., Perrot, A., and Zhang, Y. (2016a). "A nonlocal Fourier's law and its application to the heat conduction of one-dimensional and two-dimensional thermal lattices." *Comptes Rendus Mécanique*, 344(6), 388–401.
- Challamel, N., Hache, F., Elishakoff, I., and Wang, C. M. (2016b). "Buckling and vibrations of microstructured rectangular plates considering phenomenological and lattice-based nonlocal continuum models." *Compos. Struct.*, 149, 145–156.
- Challamel, N., Wang, C. M., and Elishakoff, I. (2016c). "Nonlocal or gradient elasticity macroscopic models: A question of concentrated or distributed microstructure." *Mech. Res. Commun.*, 71, 25–31.
- Chen, F. Y. (1971). "On modeling and direct solution of certain free vibration systems." *J. Sound Vib.*, 14(1), 57–79.
- Eringen, A. C. (1983). "On differential equations of nonlocal elasticity and solutions of screw dislocation and surface waves." *J. Appl. Phys.*, 54(9), 4703–4710.

- Kevrekidis, P. G., Kevrekidis, I. G., Bishop, A. R., and Titi, E. S. (2002). "Continuum approach to discreteness." *Phys. Rev. E*, 65(4), 046613.
- Kruskal, M. D., and Zabusky, N. J. (1964). "Stroboscopic-perturbation procedure for treating a class of nonlinear wave equations." *J. Math. Phys.*, 5(2), 231–244.
- Lagrange, J.-L. (1759). "Recherches sur la nature et la propagation du son." *Mathematica Societatis Privatae Taurinensis*, 1, 39–148 (in French).
- Leissa, A. W., and Qatu, M. S. (2011). *Vibrations of continuous systems*, McGraw-Hill, New York.
- Lombardo, M., and Askes, H. (2010). "Elastic wave dispersion in microstructured membranes." *Proc., Royal Society A: Mathematical, Physical and Engineering Sciences*, The Royal Society, London.
- Mindlin, R. D. (1970). "Lattice theory of shear modes of vibration and torsional equilibrium of simple-cubic crystal plates and bars." *Int. J. Solids Struct.*, 6(6), 725–738.
- Rosenau, P. (1986). "Dynamics of nonlinear mass-spring chains near the continuum limit." *Phys. Lett. A*, 118(5), 222–227.
- Rosenau, P. (1987). "Dynamics of dense lattices." *Phys. Rev. B*, 36(11), 5868–5876.
- Rutherford, D. E. (1948). "Some continuant determinants arising in physics and chemistry." *Proc. R. Soc. Edinburgh A*, 62(3), 229–236.
- Tong, P., Pian, T. H. H., and Bucciabli, L. L. (1971). "Mode shapes and frequencies by finite element method using consistent and lumped masses." *Comput. Struct.*, 1(4), 623–638.
- Wang, C. Y., and Wang, C. M. (2013). *Structural vibration: Exact solutions for strings, membranes, beams, and plates*, CRC Press, London.
- Wattis, J. A. D. (2000). "Quasi-continuum approximations to lattice equations arising from the discrete nonlinear telegraph equation." *J. Phys. A*, 33(33), 5925–5944.
- Zhang, Z., Wang, C. M., and Challamel, N. (2014). "Eringen's length scale coefficient for buckling of nonlocal rectangular plates from microstructured beam-grid model." *Int. J. Solids Struct.*, 51(25), 4307–4315.
- Zhang, Z., Wang, C. M., and Challamel, N. (2015). "Eringen's length-scale coefficients for vibration and buckling of nonlocal rectangular plates with simply supported edges." *J. Eng. Mech.*, 10.1061/(ASCE)EM.1943-7889.0000838, 4014117.