



HAL
open science

RF link for Implanted Medical Devices (IMDs) and Sub-GHz Inductive Power Transmission

Antoine Diet, Satvros Koulouridis, Yann Le Bihan, Quang-Trung Luu, Olivier Meyer, Lionel Pichon, Marc Biancheri-Astier

► **To cite this version:**

Antoine Diet, Satvros Koulouridis, Yann Le Bihan, Quang-Trung Luu, Olivier Meyer, et al.. RF link for Implanted Medical Devices (IMDs) and Sub-GHz Inductive Power Transmission. Journées d'Etude sur la TéléSANTé, 6ème édition, Pôle Capteurs, Université d'Orléans, May 2017, Bourges, France. hal-01692423

HAL Id: hal-01692423

<https://hal.science/hal-01692423>

Submitted on 25 Jan 2018

HAL is a multi-disciplinary open access archive for the deposit and dissemination of scientific research documents, whether they are published or not. The documents may come from teaching and research institutions in France or abroad, or from public or private research centers.

L'archive ouverte pluridisciplinaire **HAL**, est destinée au dépôt et à la diffusion de documents scientifiques de niveau recherche, publiés ou non, émanant des établissements d'enseignement et de recherche français ou étrangers, des laboratoires publics ou privés.

RF link for Implanted Medical Devices (IMDs) and Sub-GHz Inductive Power Transmission



A. Diet¹, S. Koulouridis^{1,2}, Y. Le Bihan¹, Q.-T. Luu¹, O. Meyer¹, L. Pichon¹, M. Biancheri-Astier¹

¹GeePs | Group of electrical engineering - Paris, UMR CNRS 8507, CentraleSupélec, Univ. Paris-Sud, Université Paris-Saclay, Sorbonne Universités, UPMC Univ Paris 06, 3 & 11 rue Joliot-Curie, Plateau de Moulon 91192 Gif-sur-Yvette CEDEX, France

²School of Electrical and Computer Engineering, University of Patras, Patras, Greece.
antoine.diet@geeps.centralesupelec.fr, koulouridis@g.upatras.gr

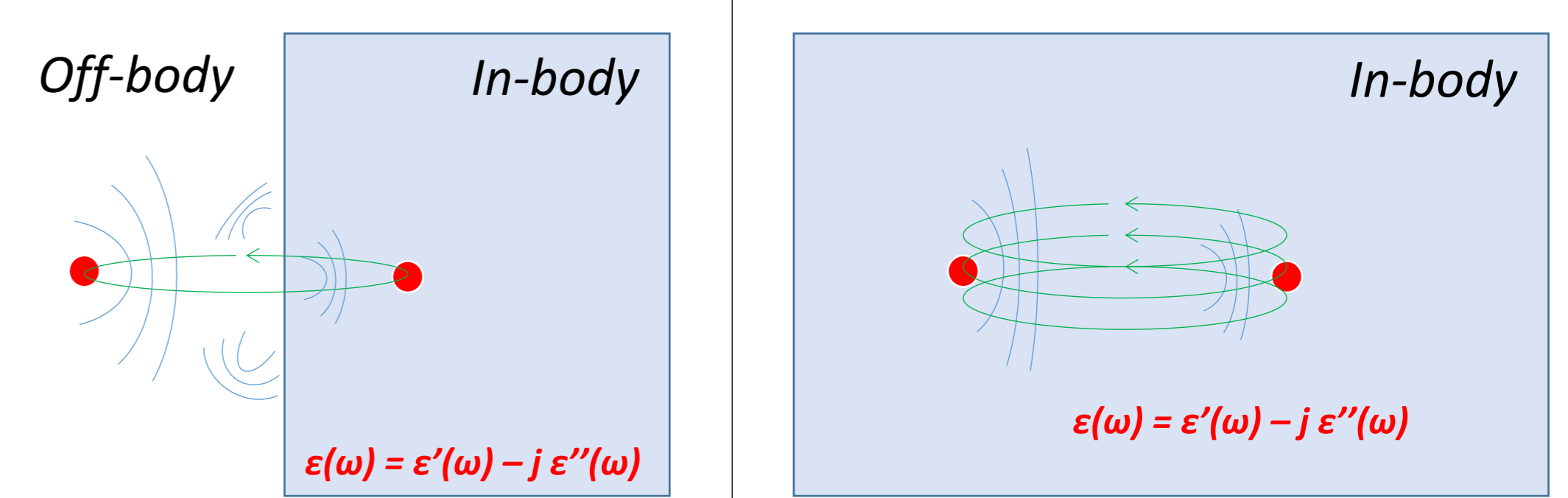
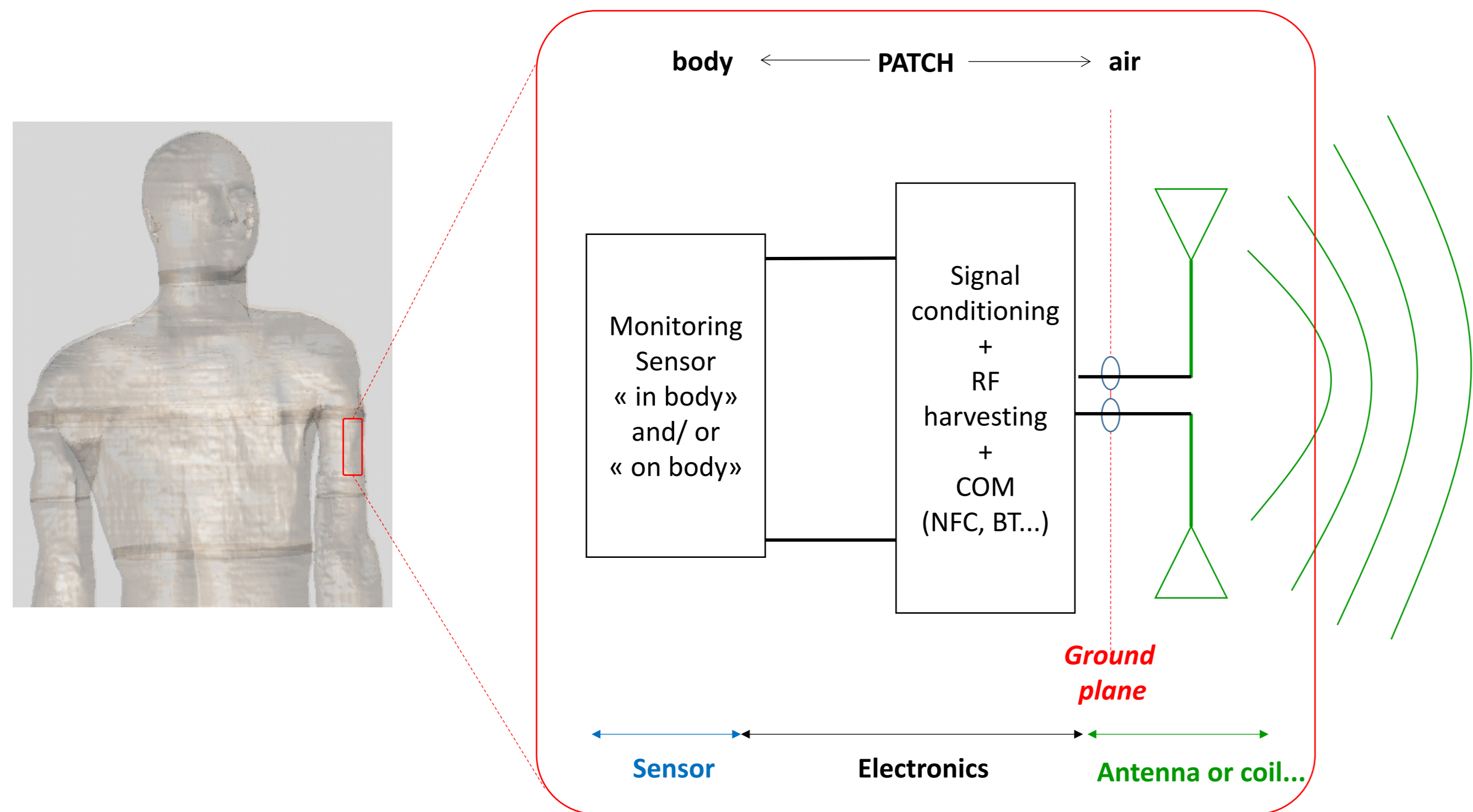

- IMDs → high impact of the body on EM fields (modelling needed with ε' and ε'') + radiating and non-radiating modes
- Design of helical RX coils → impacted by the body, lowering performances (need a figure of merit, see PTE)

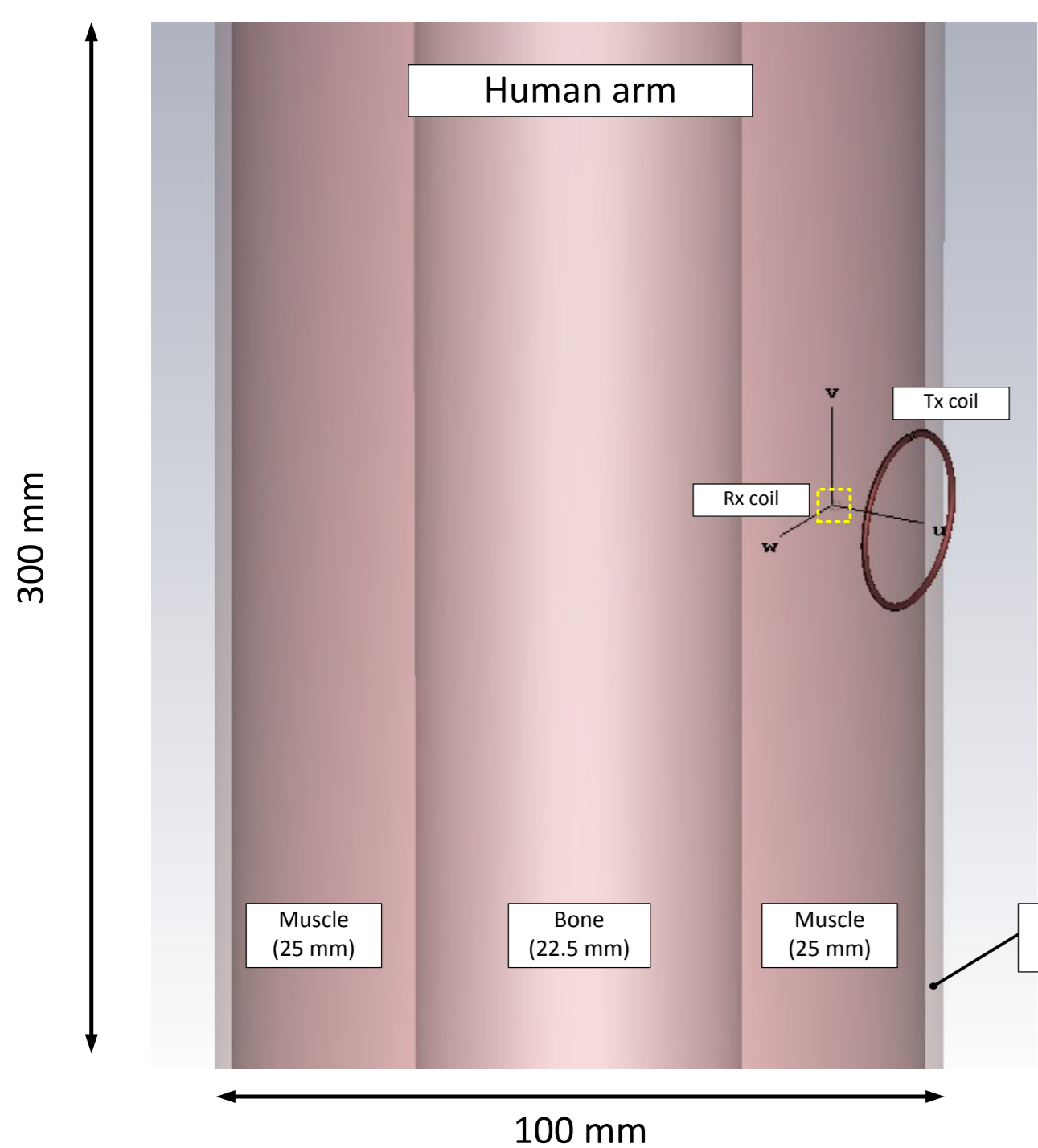

Configuration of the Tx and Rx coil			
Parameter	Tx coil	Rx coil	
Radius	12 mm	0.5 mm	
Height	1 mm	1 mm	
Number of turns	1	7	
Distance between two coils	12 mm		
Configuration of the tissue model			
Parameter	Skin	Muscle	Bone
Thickness (mm)	2.5	25	22.5
μ _r	1	1	1
ρ (kg/m ³)	1100	1041	1850
Therm. Cond. (W/K/m)	0.293	0.53	0.41
Blood flow (W/K/m ³)	9100	2700	3400

Using only two coils, Implanted depth: 10 mm

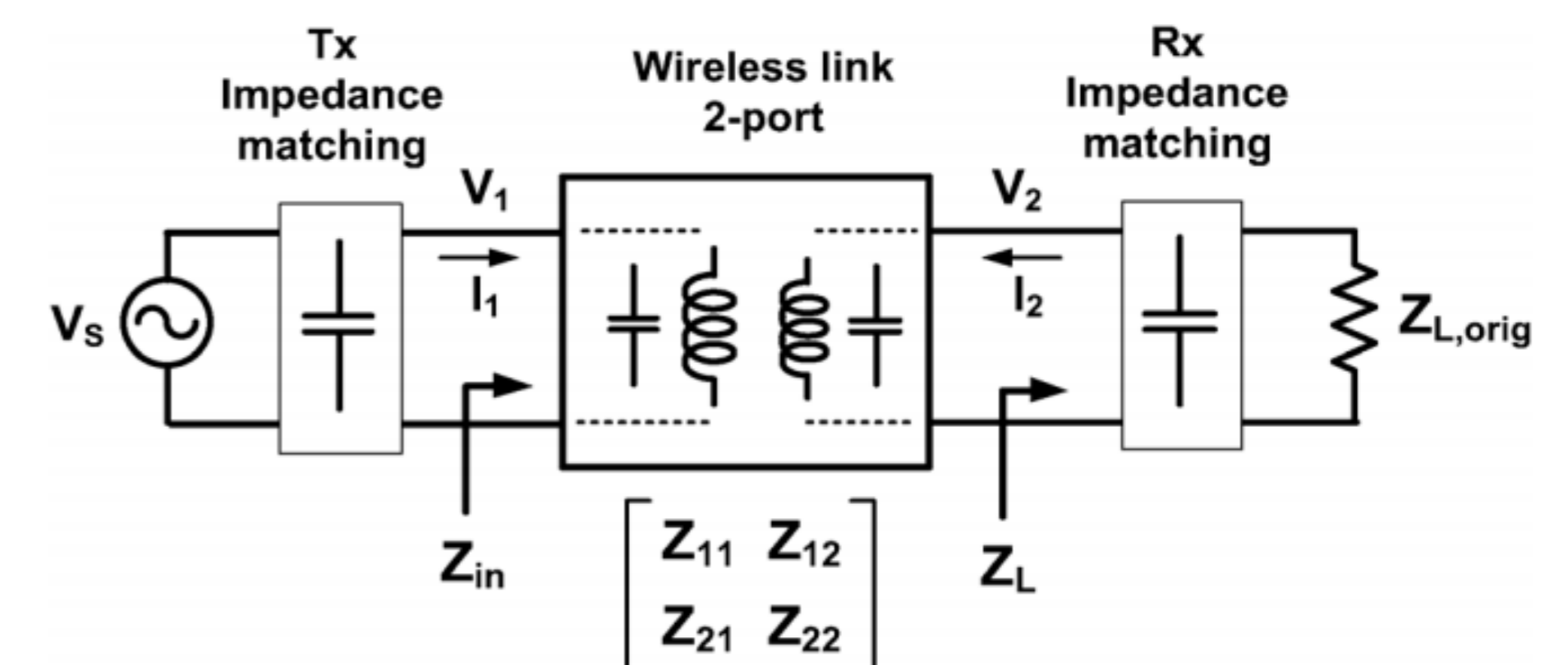
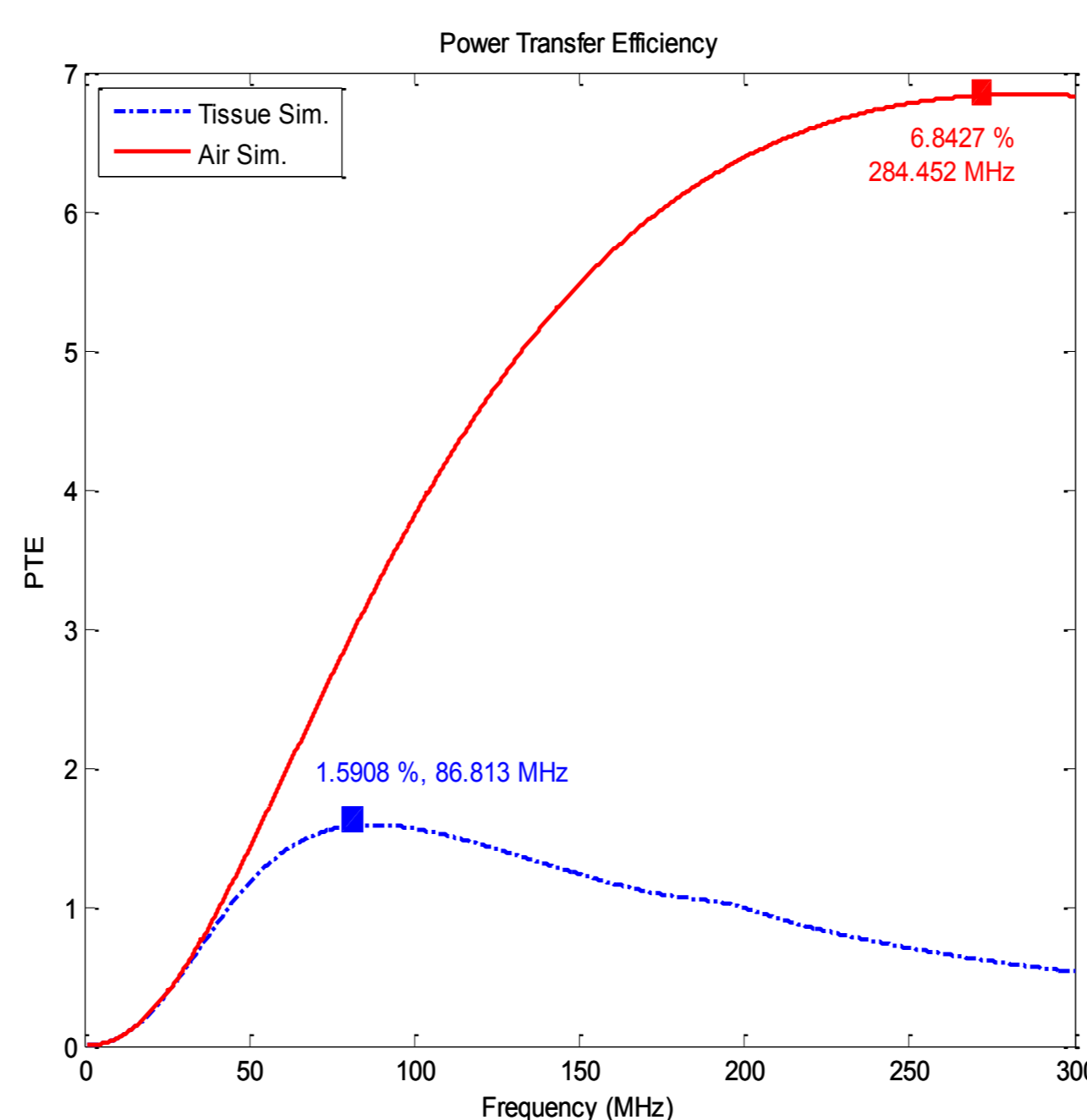
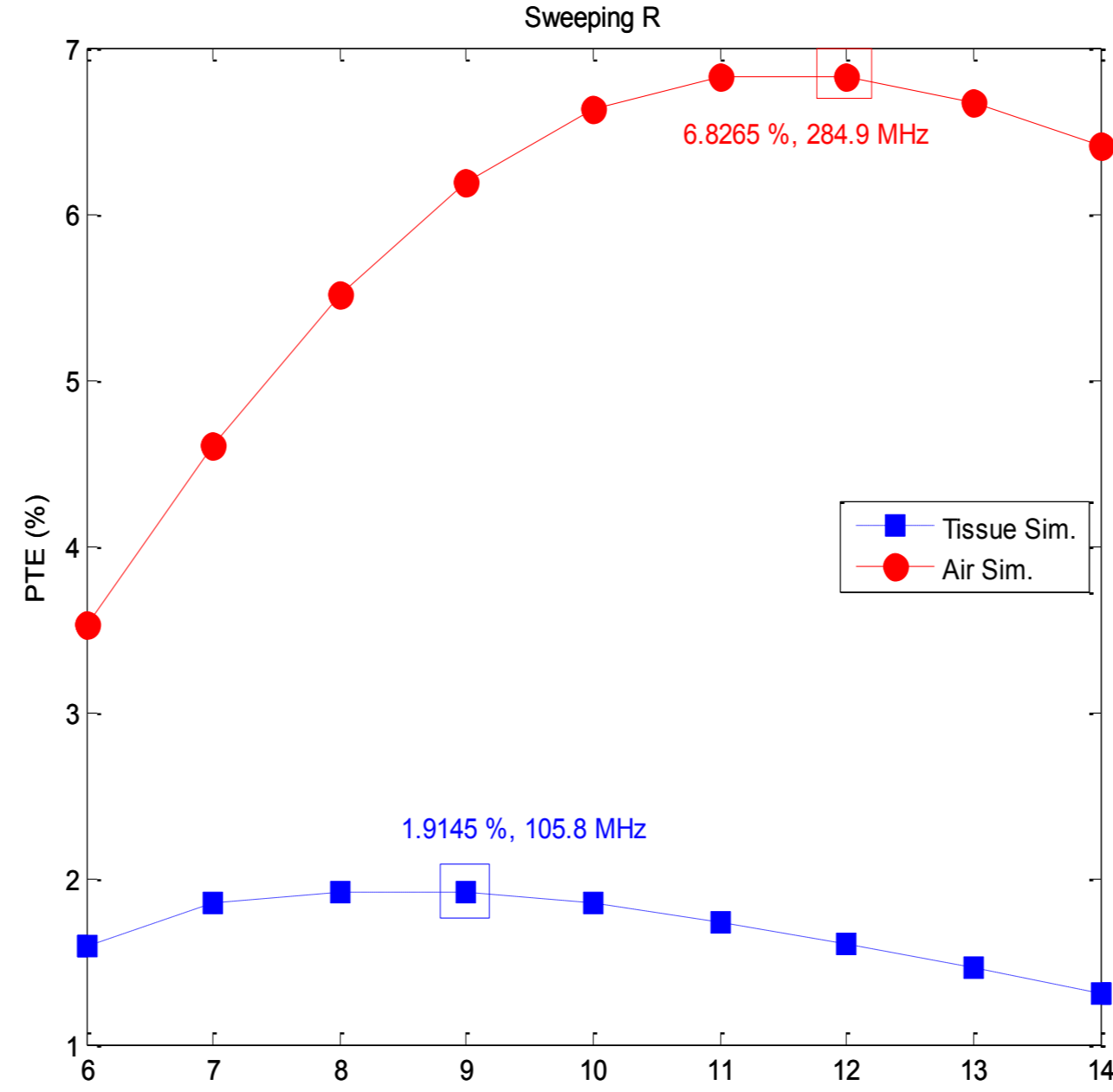

Equivalent circuit using Z-matrix as the wireless link between Tx and Rx coil
[D. Ahn et al., Optimal Design of Wireless Power Transmission Links for Millimeter-Sized Biomedical Implants, IEEE Trans. Biomed. Circuits Syst., pp. 1-13, 2014.]

Power Transfer Efficiency (PTE)

$$PTE \approx \frac{|Z_{21}|^2}{|\text{Im}(Z_{11})\text{Im}(Z_{22})|} \frac{|\text{Im}(Z_{11})|}{R_{11}} \frac{|\text{Im}(Z_{22})|}{(R_{22} + R_L)} \frac{R_L}{(R_{22} + R_L)}$$

$$= \kappa^2 Q_{TX} Q_L \eta_{Rx}$$

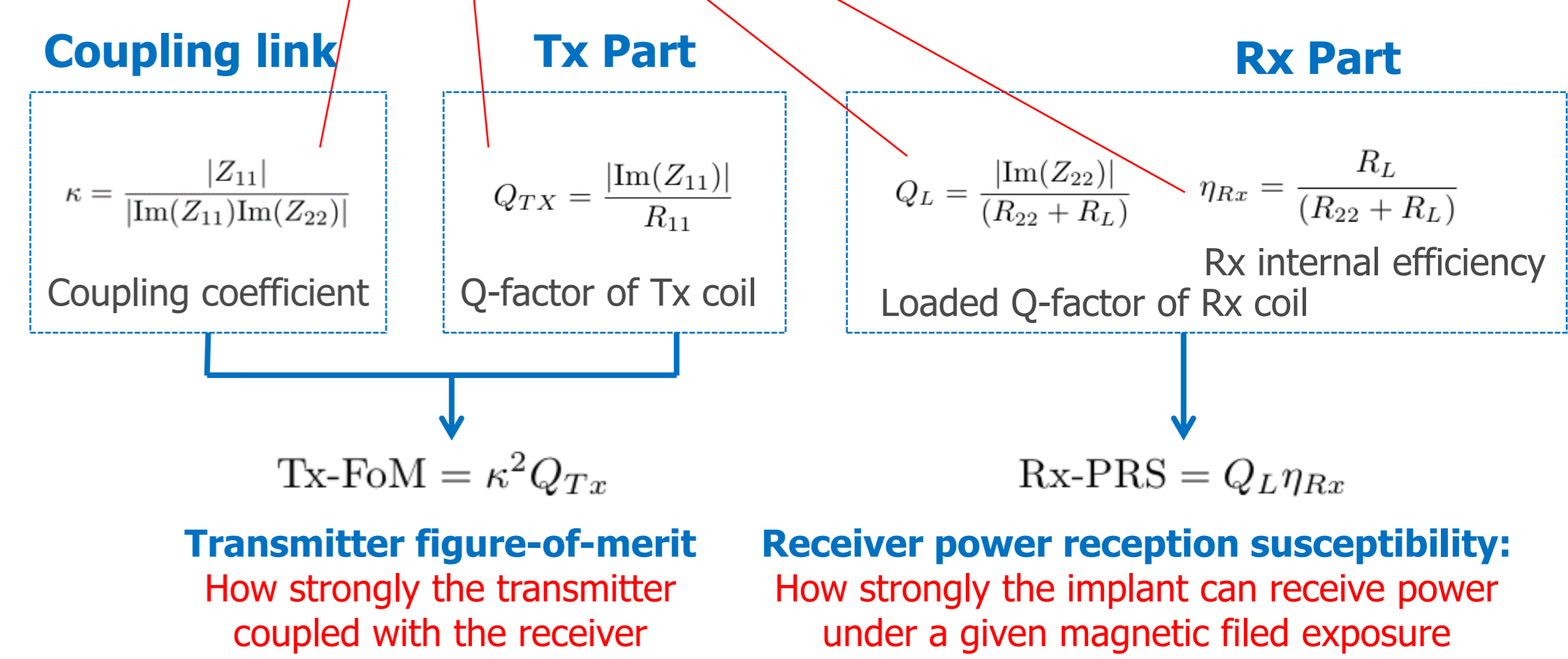

- OPTIMAL frequency, mainly due to body losses and dispersion effects
- OPTIMAL size and orientation, due to the distribution of H and E

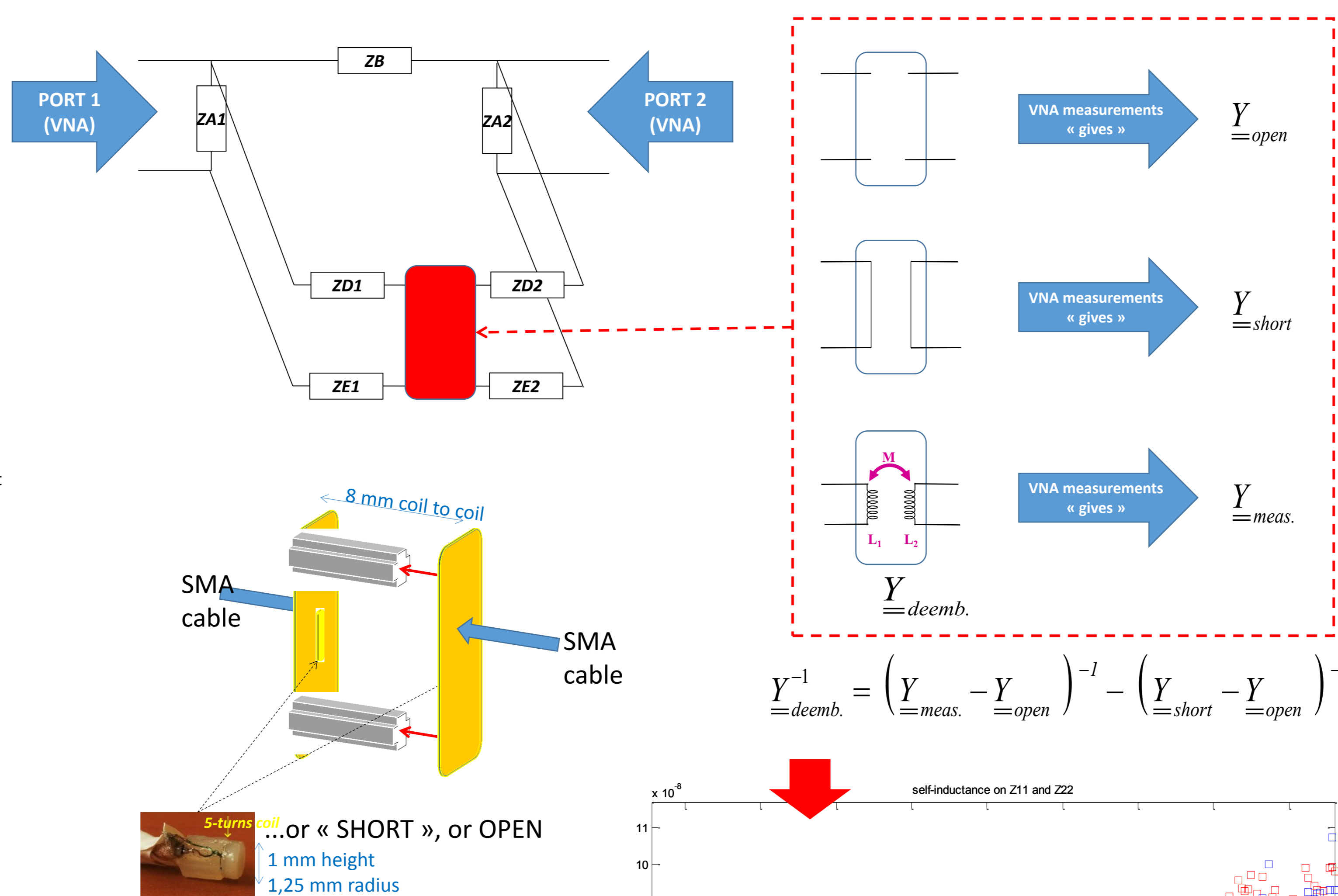
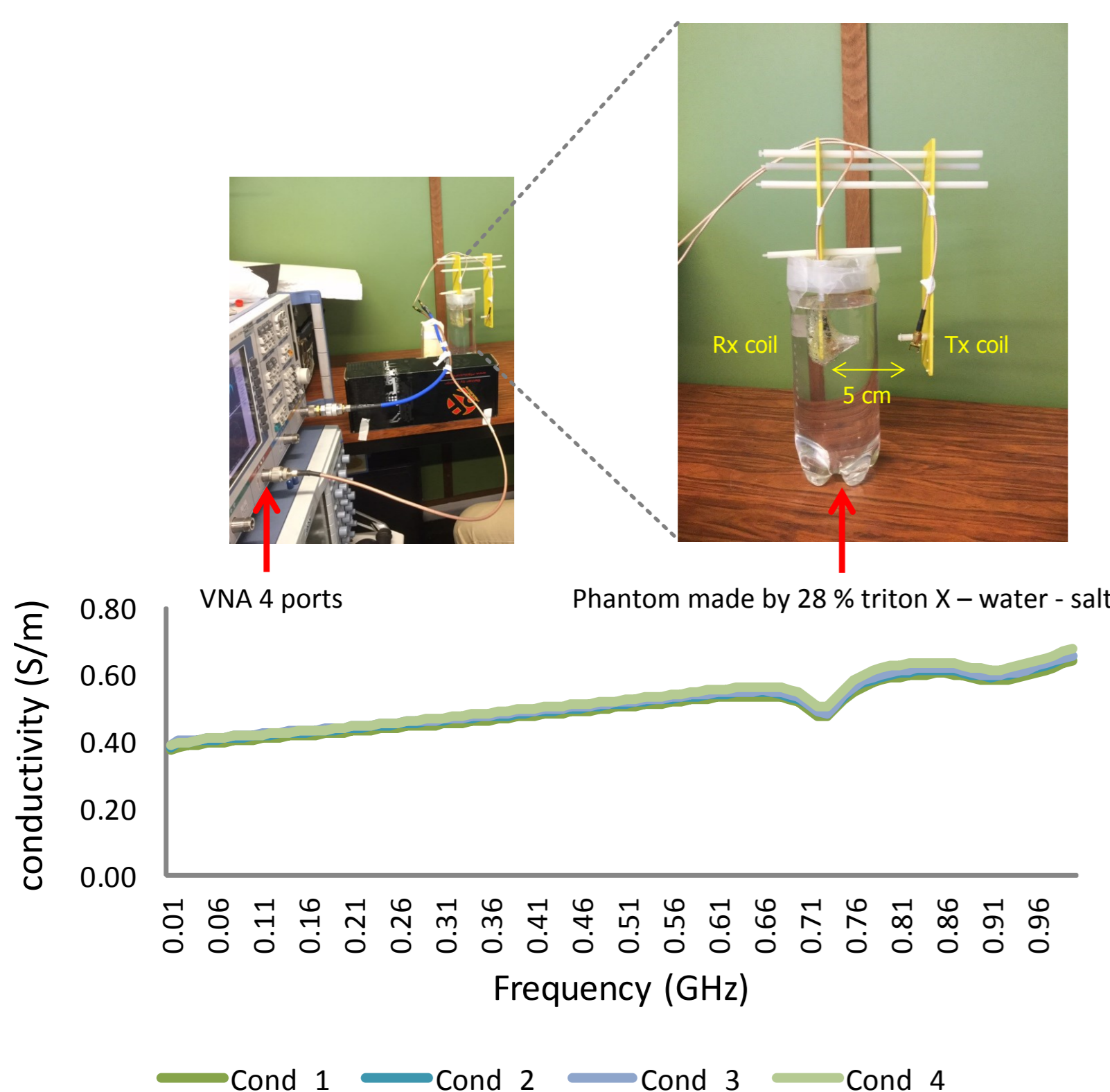
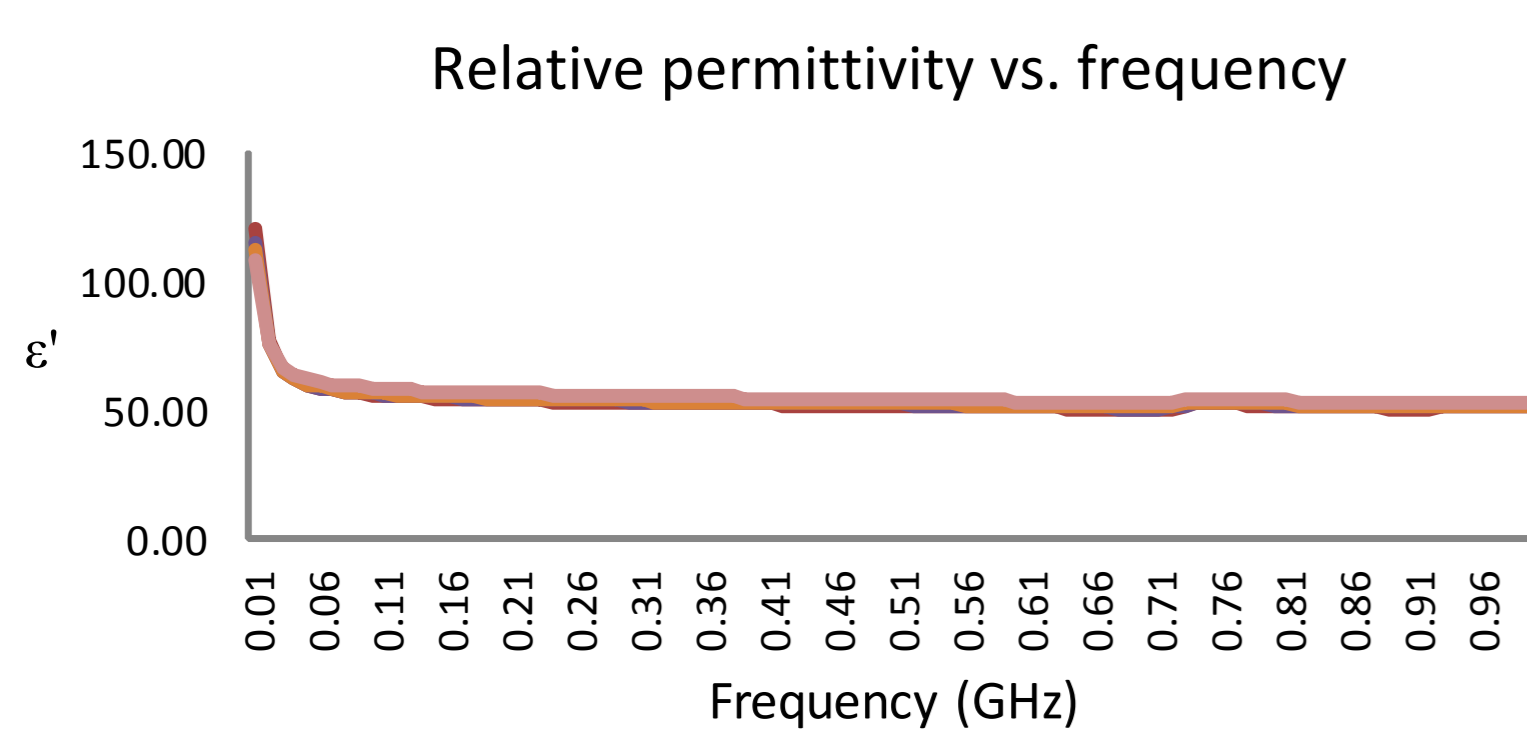
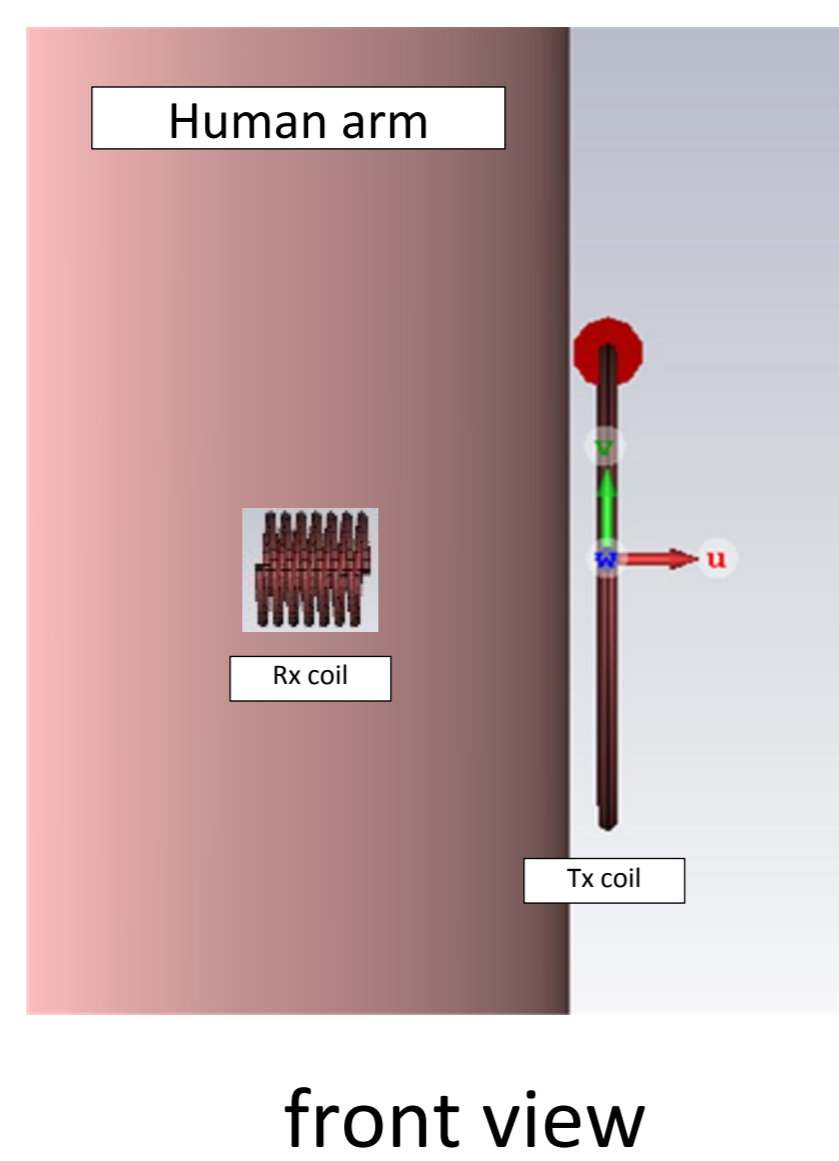
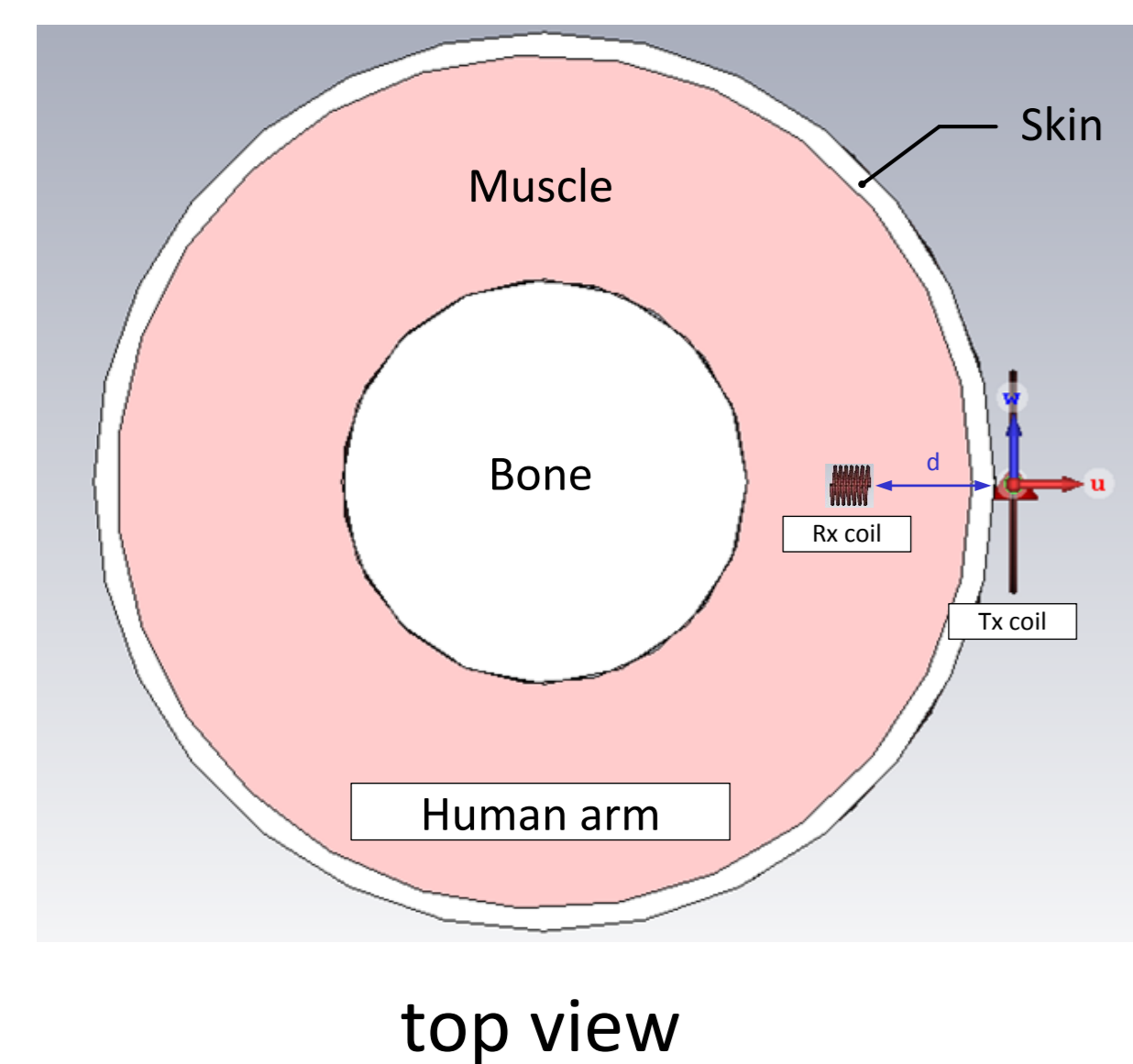

CURRENT WORK AND CONCLUSION

The measurements show an interesting agreement for self-inductance evaluation under 300 MHz with a simple calibration test fixture. Some parasitic elements are still present after deembedding and we need to improve the design of the test fixture to be able to evaluate the whole impedance matrix of the 2 coils system.

The design of the coils in the presence of a biological tissue can be fruitfully helped with measurements of the coil inside a phantom made with Triton X, water and salt.

This phantom relative permittivity and conductivity are also given in function of the frequency. Next step of the design process is to accurately deembed and re-simulate to match the characteristics of the medium for optimization of the small coils.

SAR evaluation...

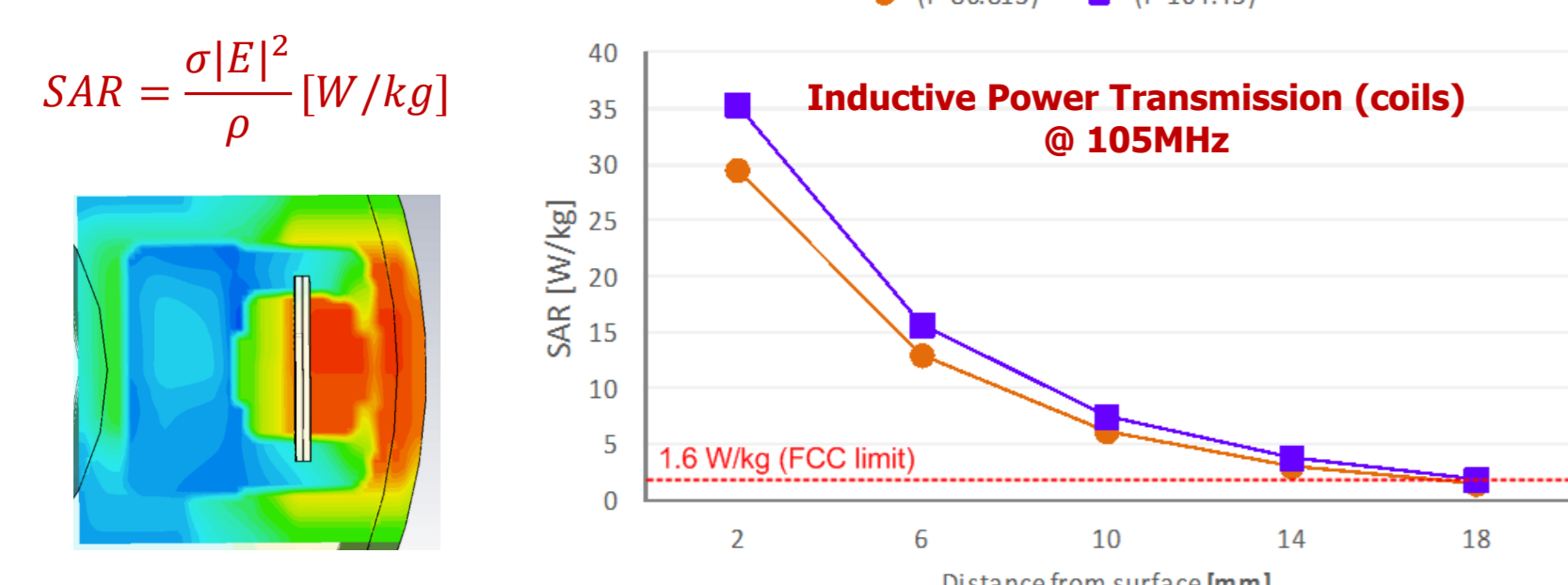

TEST FIXTURE NEEDED:

- ...for deembedding connector effects (size and frequency)
- ...for deembedded measurements in presence of the phantom (in progress)
- ...for an accurate control of the position

