



HAL
open science

Quantitative fatigue fracture surface analysis on railway axles

A Ratier, P Feraud, F. Chalon, P Lallet, Narayanaswami Ranganathan

► **To cite this version:**

A Ratier, P Feraud, F. Chalon, P Lallet, Narayanaswami Ranganathan. Quantitative fatigue fracture surface analysis on railway axles. 18th International Wheelset Congress, Nov 2016, Chendu, China. hal-01689628

HAL Id: hal-01689628

<https://hal.science/hal-01689628>

Submitted on 22 Jan 2018

HAL is a multi-disciplinary open access archive for the deposit and dissemination of scientific research documents, whether they are published or not. The documents may come from teaching and research institutions in France or abroad, or from public or private research centers.

L'archive ouverte pluridisciplinaire **HAL**, est destinée au dépôt et à la diffusion de documents scientifiques de niveau recherche, publiés ou non, émanant des établissements d'enseignement et de recherche français ou étrangers, des laboratoires publics ou privés.

Quantitative fatigue fracture surface analysis on railway axles

A.Ratier^{1,2}, P.Feraud¹, F.Chalon², P.Lallet¹ and N.Ranganathan²,

¹SNCF Agence d'essais ferroviaires, 21 Avenue du Président Allende, 94407 Vitry-sur-Seine, France

²Laboratoire de Mécanique et rhéologie, Université François Rabelais de Tours, 7 Avenue Marcel Dassault, 37200 Tours, France
alexis.ratier@sncf.fr

Abstract: For passengers' safety and to improve railway axles maintenance, the French railway company, SNCF, studies the evolution of crack length in function of time in fatigue loading situations. To achieve this, it's necessary to know the in-service axle loading. As in-service measurements are very expensive and specific, authors decided to study fracture surfaces of components cracked or broken in service. So, the question is: how can we determine the loading history of a cracked component studying the fracture surfaces? This amounts to determining fracture mechanics parameters such as the maximum stress intensity factor K_{max} along the crack path. Authors have ever transferred a quantitative fractographic analysis method from aluminium alloys to axle steel EA4T. This method is based on quantification of significant fractographic features such as striations. But, due to limits of this one, authors decided to add another technique based on X-ray diffraction measurements. In this paper, results of these methods are highlighted and discussed.

Keywords: Railway axles; loading history; quantitative fractography; XRD

1 Introduction

For passengers' safety and to improve maintenance, the French railway company, SNCF, generally studies the evolution of crack length in function of time in fatigue loading situations. To this aim, crack propagation models are used. To achieve this, input data are: the component geometry, the material properties and the in-service loading. The latter is usually determined by in-service measurements. However, this solution is very expensive and the loading obtained is very specific (for one equipment, for one itinerary...).

That's why the current study is to explore another way to determine the in-service loading. Authors decided to extract such data from a study of fracture surfaces of components cracked or broken in service.

So, the question is: how can we determine the loading history of a cracked or broken component studying the fracture surfaces? This amounts to determining fracture mechanics parameters such as the maximum stress intensity factor K_{max} and the load ratio R along the crack path.

Different methods have ever been developed to this end and have met with limited success- These methods (not exhaustive) rely upon Striation topography [1], Texture analysis [2] or Fractal analysis [3]

The above references are given as examples and the list is not complete. One of the reasons for the lack of success for such techniques is that fatigue fracture surfaces reflect the local fracture mechanisms and sometimes it is difficult to identify the mechanisms involved by automated techniques. In fact the micro-mechanisms depend upon the material; the environment and the loading conditions.

The authors have adopted a quantitative fractographic analysis method developed for aluminium alloys [4] to a structural steel [5]. This method permits the estimation of the maximum stress intensity factor K_{max} and an "equivalent load ratio" that lead to the fatigue failure. It is based

on the hypothesis that all the grains across the crack front do not undergo the same mechanical loading as that determined by the remote loading. This aspect can be understood from figure 1 which shows an Electron Backscattered diagram mapping of the studied steel. In this figure, grains with similar orientations have the same color. It can clearly be seen that there is a strong variation in grain orientations.

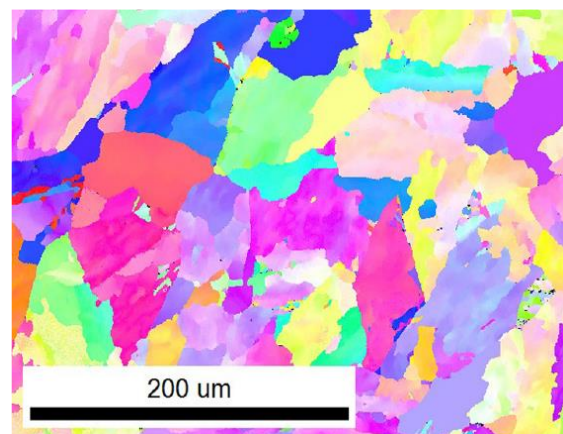

Figure 1. Grain orientation changes across a surface

The original study [4] shows that the spatial distribution of significant fractographic features such as striations, secondary crack length and dimples can lead to the determination of K_{max} and the load ratio R under constant amplitude loading conditions.

In aluminium alloys, the fractographic features observed are:

- *Crystallographic facets.* These ones have been identified to occur on (111) planes, by etch-pitting techniques [6]. This kind of features are observed in aluminium alloys tested in vacuum at low ΔK values, near threshold and in texture alloys in air [6]

- *Pseudo-cleavage facets*. Such features have been identified by Lynch [7] as crack propagation occurring simultaneously along two [110] directions and lying on a (100) plane. In this plane, the crack profile can follow slip lines.

- *Striations*. Two kinds can be identified: classical ductile striations, according to the mechanism identified by Laird [8], and fragile striations [4]. In such cases the crack path is quite straight.

- *Dimples*: two kinds can be identified – small circular dimples and elongated ones, the crack path can be slightly tortuous as the crack may follow local inclusions. In fact the occurrence of dimples in fatigue loading has been discussed in [9]

- *Secondary cracks*. In this case, the crack may follow the grain boundaries, if there is an environmental effect associated.

The paper [5] displays the transfer of this method to a railway axle steel and especially its limits and the means of improvement. Indeed, this technique, being manual, suffers of large uncertainties.

The results obtained in structural steels are presented and discussed in [10], where the evolution of significant fractographic features are presented and discussed.

To improve this first study, authors decided to use X-ray diffraction (XRD) measurements. First results with this method are shown in paper [10]. These ones have been first performed on the surface, and then in depth, as developed in [11]. To study the effect (or not) of microstructure, authors applied these methods to two railway axle steels. These ones are bainitic (A4T) and ferritic-pearlitic (A1N). The final aim is to couple the two methods to improve the predictive capacities of the two techniques.

Current paper presents further results with these two methods, on A4T steel.

2 Materials and Methods

2.1 Materials

Tables 1 and 2 show the chemical composition and nominal properties of the studied material: the A4T steel (25CrMo4) which is bainitic. A4T and A1N steels are the most used for European railway axles.

Table 1. Chemical composition A4T and A1N steels

Nuance	C	Mn	Si	S	P	Ni	Cr	Mo	Cu	Fe
A4T	0.29	0.68	0.33	0.009	0.009	0.22	1.12	0.26	0.22	base

Table 2. Nominal properties of A4T and A1N steels

Nuance	Yield stress (MPa)	Ultimate tensile stress (MPa)	Elongation (%)
A4T	560	730	22.5

2.2 Specimens

Middle-crack tension (M(T)) and compact in tension (C(T)) specimens have been used. These ones have been extracted from railway axles, according to the figure 2, as close as possible to the surface.

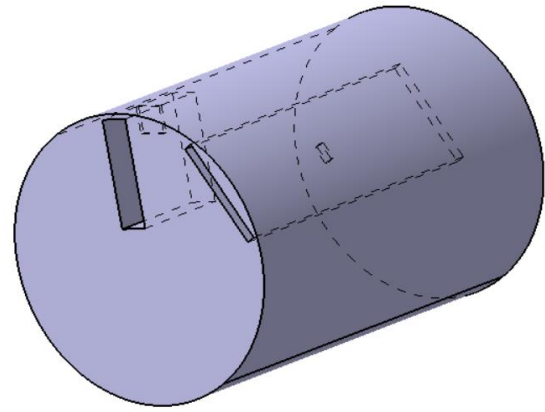

Figure 2. M(T) and C(T) specimens taking on railway axle

A stress relieving treatment has been realized on specimens to agree with real conditions. To this end, a vacuum furnace has been used; at a temperature of 590 °C, maintained during an hour before a slow temperature decrease in the furnace.

2.3 Fatigue tests

Constant amplitude tests were carried out at loading ratios of -1 using M(T) specimens and at loading ratio 0.1 using C(T) specimens. A constant ΔK test was also carried out on C(T) specimen with 3 different loading ratios, like defined in Table 3.

Table 3. Description of constant ΔK test

ΔK (MPa \sqrt{m})	14		
	I (2 to 5 mm)	II (5 to 8 mm)	III (8 to 11 mm)
R	0.1	0.4	0.7
K_{max} (MPa \sqrt{m})	15.6	23.3	46.7

After the tests, the broken surfaces were examined by two fractographic methods:

2.4 Fractographic features quantification

This method, developed by N.RANGANATHAN [4], consists in determining the spatial coverage of fractographic features like striations or dimples.

The fracture surface is cleaned in an ultrasonic bath and the specimen is placed in a Zeiss scanning electron microscope. The observations are made in the central plane strain region. The features can be different near the edges in plane stress and this aspect is not treated here.

At different crack lengths (different ΔK levels), photographs are taken at high magnification (3000x); for each crack length, at least three photographs are used. A grid is then placed on the photographs (figure 4) and the areal coverage of each fractographic feature is counted, according to the method proposed in [12].

This method is adapted here to determine the sum of secondary cracks length per image.

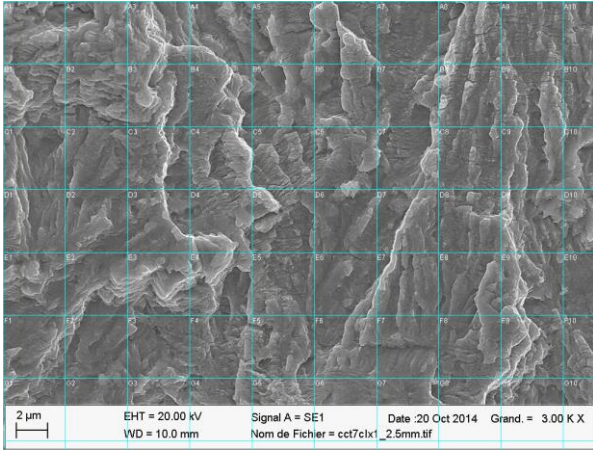

Figure 3. SEM photograph with a grid for quantitative analysis

2.5 X-ray diffraction method

As in-service fracture surfaces can be damaged (due to corrosion effects or matting due to crack closure), authors decided to carry out in-depth X-ray diffraction measurements. These are carried out with an iXRD diffractometer. Lattice deformation of 211 diffraction planes of the α -Fe phase were measured using Cr X-ray radiation. The irradiated area was equal to 2 mm² and obtained with a collimator.

These XRD measurements permit us to know the in-depth evolution of residual stresses acting in the direction of crack propagation. Material was removed by electro-polishing and depth controlled with a roughness meter. Similar studies have been done by A.BIGNONNET [13] and F.PARIENTE [11].

3 Results and Discussion

3.1 Fractographic features quantification

To complete results on striations quantification [10], authors decided to use this method on secondary cracks. Figure 4 shows the evolution of secondary cracks length in function of the maximum stress intensity factor. These measurements were realized on two M(T) fracture surfaces achieved with a loading ratio $R=-1$.

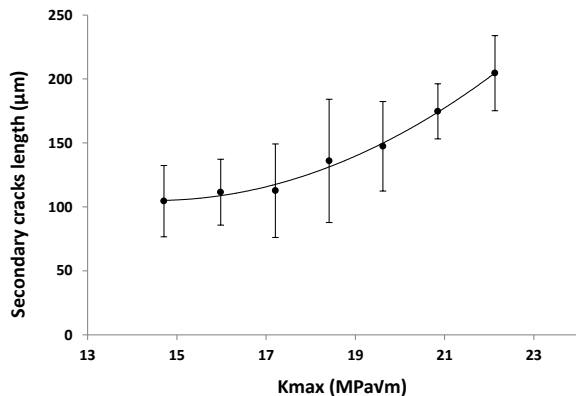

Figure 4. Secondary cracks length in relation to K_{max} – $R=-1$

Figure 4 shows a significant increase of total secondary cracks length with K_{max} rise. In the same way, secondary cracks number and average length are also increasing with K_{max} .

3.2 X-ray Diffraction method

In-depth XRD measurements were realized on M(T) specimen cracked with a constant amplitude test at a loading ratio of -1. These measurements were done at three maximum stress intensity factors:

- $K_{max} = 16 \text{ MPa}\sqrt{\text{m}}$ – $a = 3 \text{ mm}$
- $K_{max} = 18 \text{ MPa}\sqrt{\text{m}}$ – $a = 6 \text{ mm}$
- $K_{max} = 23 \text{ MPa}\sqrt{\text{m}}$ – $a = 9 \text{ mm}$

Figure 5 shows the fracture surface (red) and the central electro-eroded area (green) where were carried out residual stresses measurements. Figure 6 shows the trend of residual stresses in function of depth.



Figure 5. Fracture surface with a central electro-eroded area

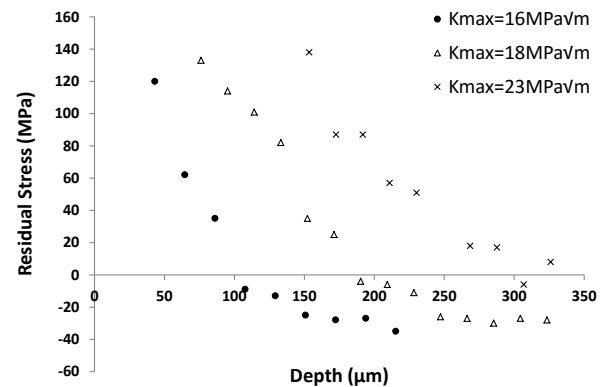

Figure 6. In-depth residual stress trend – M(T) specimen – $R=-1$

These results are in agreement with those obtained in [10] and [11] with a decrease of residual stresses in depth. In agreement with [14], residual stresses distribution was inversely proportional to the square root of the depth.

The monotonic plastic zone size (PZS) corresponds to the depth where zero stress is reached. Thus, Figure 6 illustrates, by the increase of monotonic PZS with K_{max} rise, the following equation using conventional relations, as reported in [15]:

$$r_{pm} = \alpha(K_{max}/\sigma_{ys})^2 \quad (1)$$

where r_{pm} is the monotonic PZS, K_{max} is the maximum stress intensity factor, σ_{ys} is the monotonic yield stress and α is a material dependent coefficient. The latter is empirically determined.

In-depth XRD measurements were also realized on C(T) specimen at constant ΔK equal to 14 MPa \sqrt{m} , at three loading ratios. We can see on the fracture surface (Figure 7) three different zones I, II and III previously defined in Table 3.

Figure 8 shows the trend of in-depth residual stresses measured in zone I, at two different crack lengths ($a=3.5\text{mm}$ and $a=4.5\text{mm}$). In this zone, K_{\max} is constant and equal to 16 MPa \sqrt{m} .

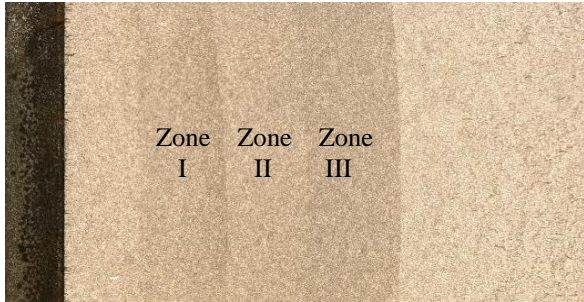

Figure 7. Fracture surface of C(T) constant ΔK test

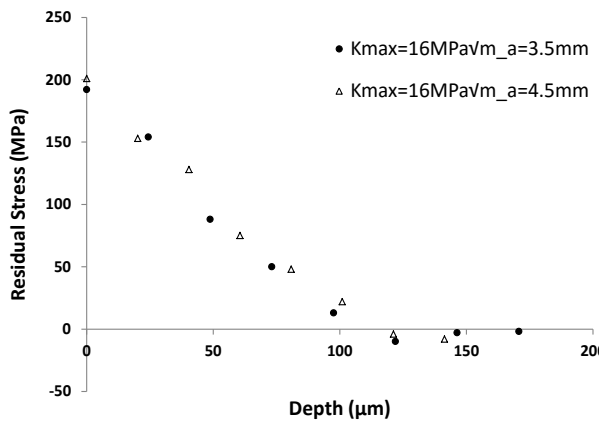

Figure 8. In-depth residual stress trend – C(T) specimen– Zone I

As expected (1), figure 8 shows that same K_{\max} results in same PZS measurement. Moreover, these results on C(T) specimen are in agreement with those on M(T) specimen, previously introduced.

More experiments are necessary to precisely define the value of the coefficient α .

5 Conclusion and prospects

The fractographic features quantification method has been used on M(T) specimens, for the loading ratio -1. It enabled us to determine the trend of total secondary cracks length in relation to K_{\max} .

The XRD method has been used on M(T) and C(T) specimens. It enabled us to determine the trend of in-depth residual stresses, and so the monotonic plastic zone size for each studied K_{\max} value.

More experiments with this XRD method will permit us to define the coefficient α .

Residual stresses redistribution due to electro-polishing will also be studied. To this effect, non-destructive meas-

urements will be carried out by synchrotron and compared with destructive measurements.

The methods have to be developed in detail based on further experimental investigations. Repeatability and reproducibility will be studied to define uncertainties.

Response of these methods to a variable amplitude loading (Figure 9), from the SNCF database, will be studied. Transferability to real axles will be considered realizing full-scale fatigue tests. And finally, the methods will be tested on railway axles from service.

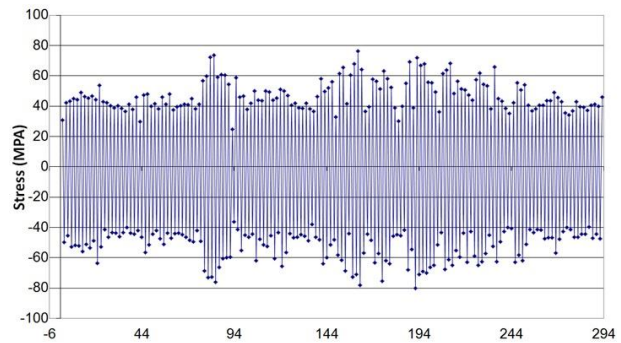

Figure 9. Railroad spectrum (rotating bending)

References

- [1] MURAKAMI, Y., FURUKAWA, K. "A method for determining stress ratio of fatigue loading from the width and height of striation" Int. J. Fatigue Vol. 20, No.7, pp. 509-516, (1998)
- [2] J.CARRERA et al, Computational materials Science, 3, pp1-8, (1994)
- [3] A.M.GOKHALE, J.R.PATEL, materials Characterization, 54, pp 13-20, (2005)
- [4] N.RANGANATHAN et al, Fractography of Modern Engineering Materials, Composites and metals, Second volume, ASTM STP 1203, ASTM, Philadelphia, pp 71-94, (1987)
- [5] N.RANGANATHAN et al, A method for quantitative fatigue fracture surface analysis, Proceeding of the 4th International Conference on Crack Paths, Gaeta, Italy, (2012)
- [6] S.Q., LI et al, Materials Sciences and Engineering A, volume 119, pp 59-72, (1989)
- [7] S.P.LYNCH, Materials Sciences and Engineering A, 468-470, pp 74-80, (2007)
- [8] Campbell Laird, The physical basis of metal fatigue Materials Science and Engineering, 5(6), 356-357 (1970)
- [9] A.Grichel, Fatigue Dimples, Journal of Failure Analysis and Prevention, Volume 9, pp193-196, (2009)
- [10] A.RATIER et al, An X-ray diffraction method to improve fatigue fracture surface analysis, Journal of Failure Analysis and Prevention, Volume 16 Issue 2, (2016)
- [11] F.PARIENTE, M. GUAGLIANO, X-ray fractography of a diesel engine crankshaft, Fatigue and Fracture of Engineering Materials and Structures 31, pp 111-124, (2007)
- [12] E.E. UNDERWOOD and E.A. STARKE, Jr, ASTM STP 675, American Society for Testing and Materials, pp 309-321, (1988)
- [13] A.BIGNONNET et al, Fatigue failure analysis by X-ray fractography, Proceedings of the Advances in Fracture Research (ICF7), Pergamon Press Publishers, pp 3457-3463 (1989)
- [14] J.L. Lebrun et al, Eigenspannungen (E. Macherauch und V. Hauk, Ed.), 235. DGM, Oberursel RFA (1983)
- [15] Tien Dung Do, Florent Chalon, Ren é Leroy, Damien Joly, and Naryanaswami Ranganathan", pp 175-198, "Material Characterization : Modern Methods and Applications", Scientific Editor - N.Ranganathan, Pan Stanford Publications, Print ISBN: 9789814613064 , 2015