



HAL
open science

Investigation of Al/CuO multilayered thermite ignition and combustion

Andréa Nicollet, Lorena Marín, Andres Belisario, Carole Rossi

► **To cite this version:**

Andréa Nicollet, Lorena Marín, Andres Belisario, Carole Rossi. Investigation of Al/CuO multilayered thermite ignition and combustion : Influence of the heating surface area, bilayer number, and layering. European Materials Research Society Spring Meeting, May 2017, Strasbourg, France. , 2017. hal-01688056

HAL Id: hal-01688056

<https://hal.science/hal-01688056>

Submitted on 19 Jan 2018

HAL is a multi-disciplinary open access archive for the deposit and dissemination of scientific research documents, whether they are published or not. The documents may come from teaching and research institutions in France or abroad, or from public or private research centers.

L'archive ouverte pluridisciplinaire **HAL**, est destinée au dépôt et à la diffusion de documents scientifiques de niveau recherche, publiés ou non, émanant des établissements d'enseignement et de recherche français ou étrangers, des laboratoires publics ou privés.

Investigation of Al/CuO multilayered thermite ignition and combustion

Influence of the heating surface area, bilayer number, and layering

Andréa Nicollet, Lorena Marin, Andrés Belisario, Carole Rossi

LAAS-CNRS, University of Toulouse, 7 Avenue du colonel Roche, Toulouse, France

Al/CuO multilayered thermite

Stack of Aluminum and Copper oxide nanolayers

High heat of reaction

Self-sustained combustion reaction

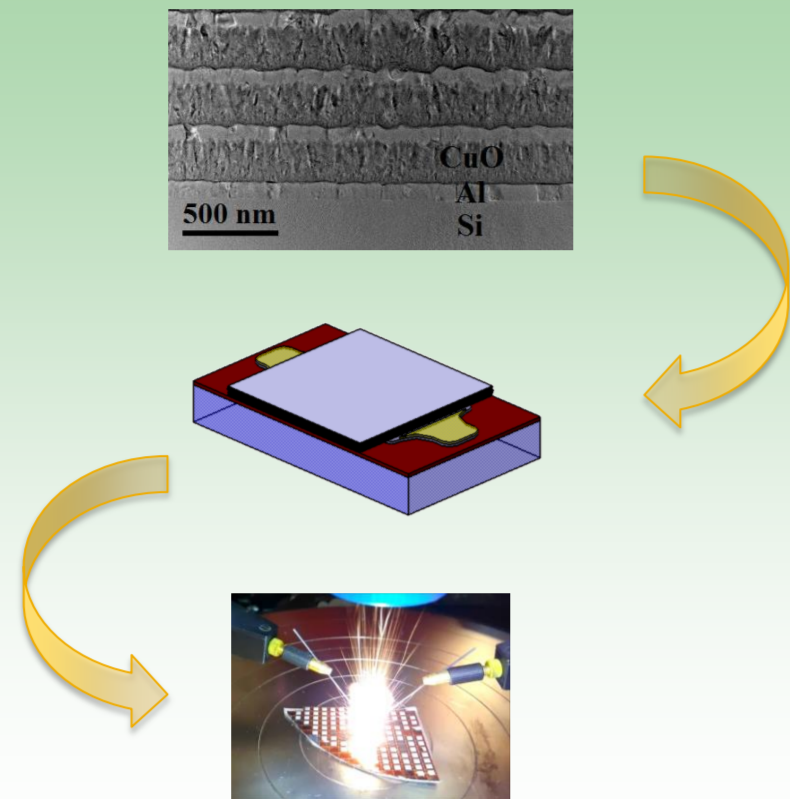

Applications:

- Impact ignition of high explosives
- Drug injector
- Safe arm and fire device
- Microthruster

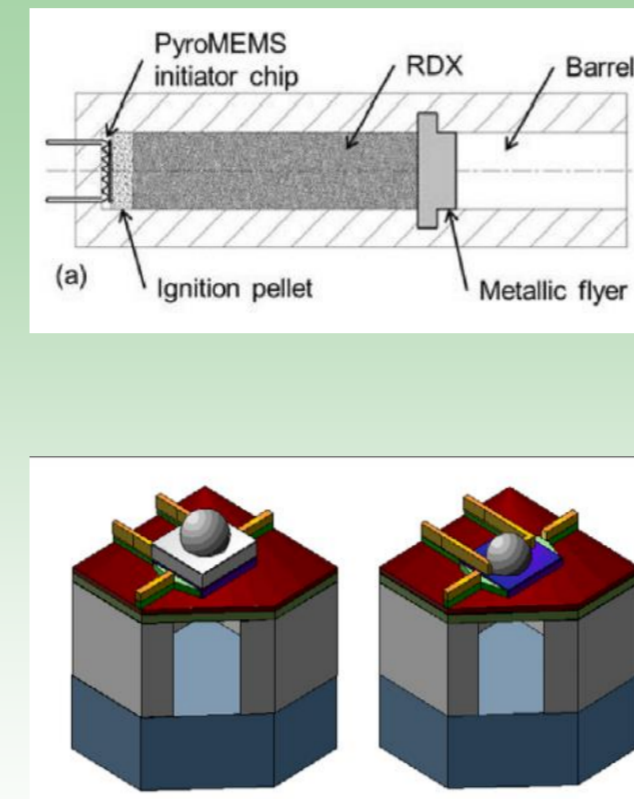

Goal:

In this work, we evaluated the influence of the heating conditions and nanothermite layering on the nanothermites ignition characteristics (ignition time, spark intensity, combustion velocity).

Some of the information in this poster is described in A. Nicollet et al. 'Investigation of Al/CuO multilayered thermite ignition': JAP DOI: 10.1063/1.4974288.

Electro-pyrotechnic initiators fabrication

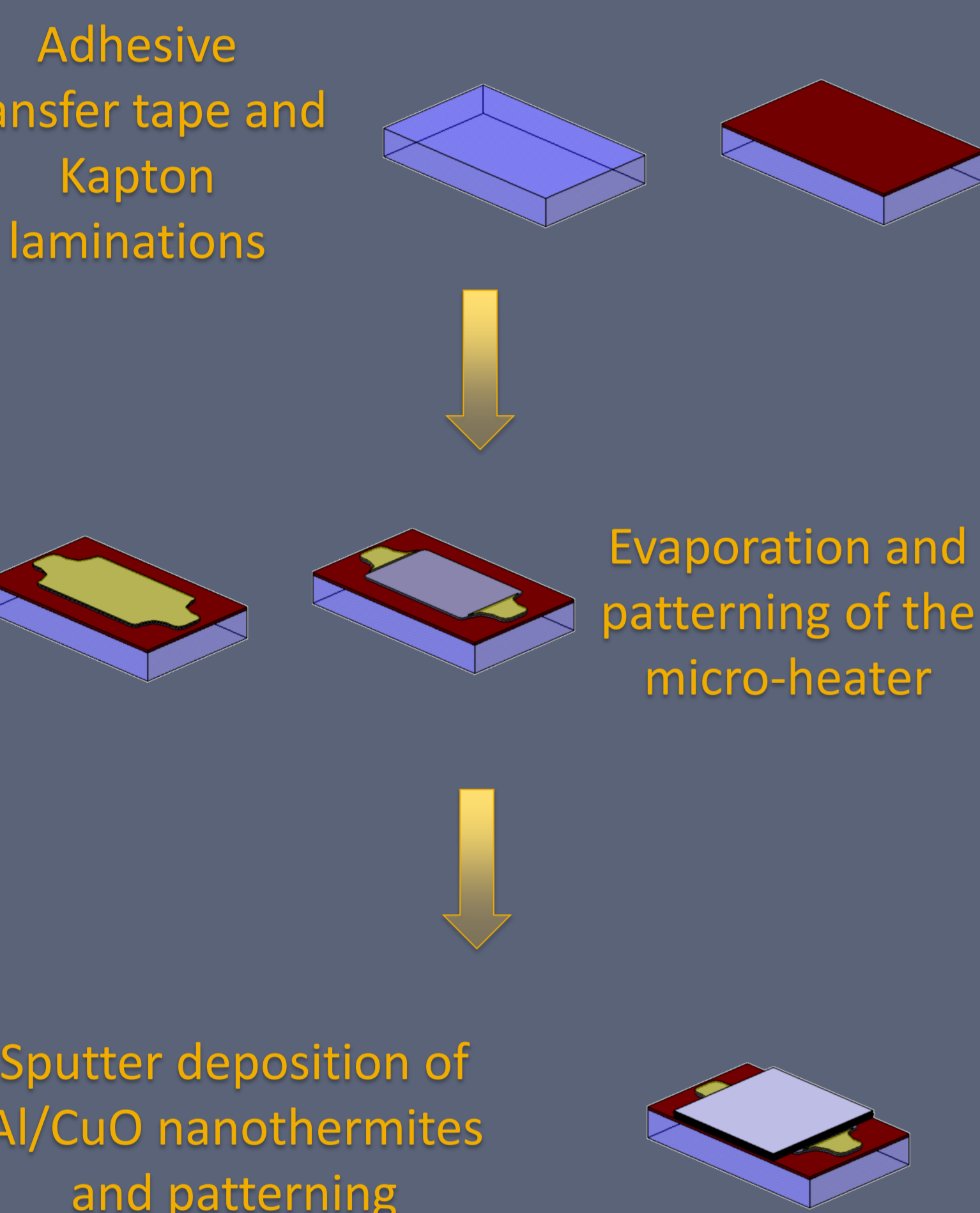

Characterizations

Ignition experiment

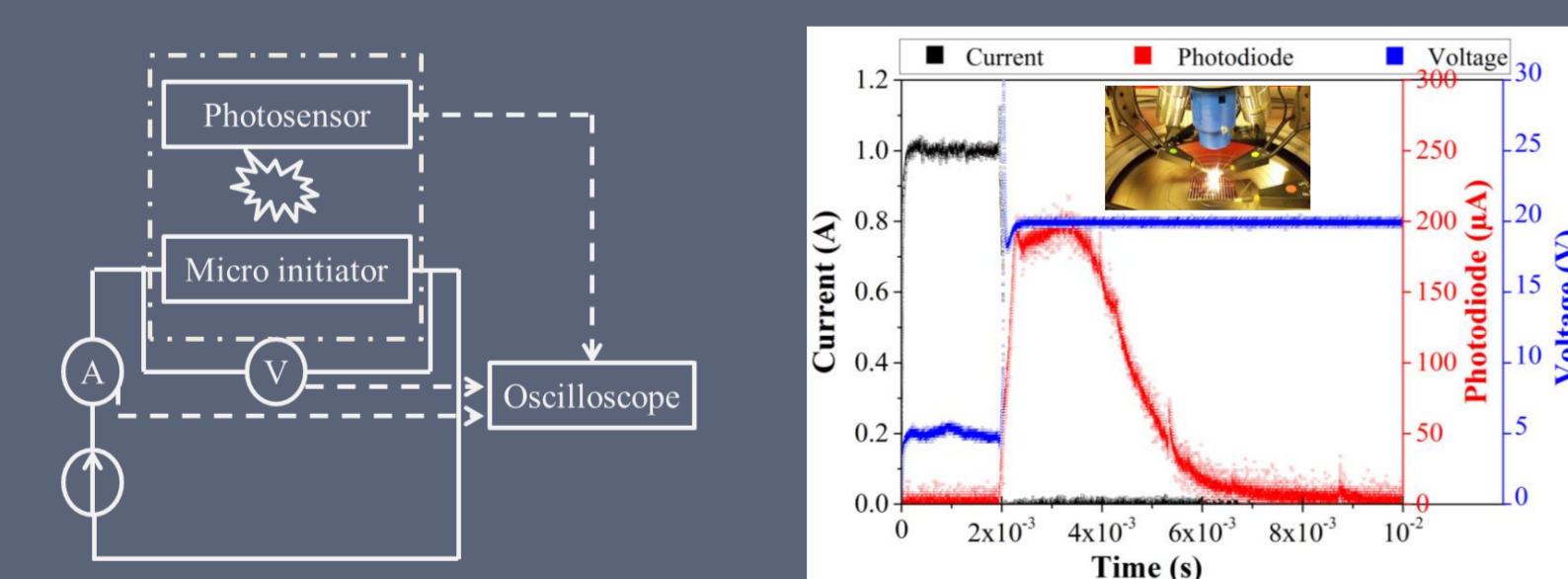

- Ignition time
- Maximum of the photodiode signal → Visible light intensity (sparks)
- Integral of the photodiode signal → Heat of reaction

Combustion experiment

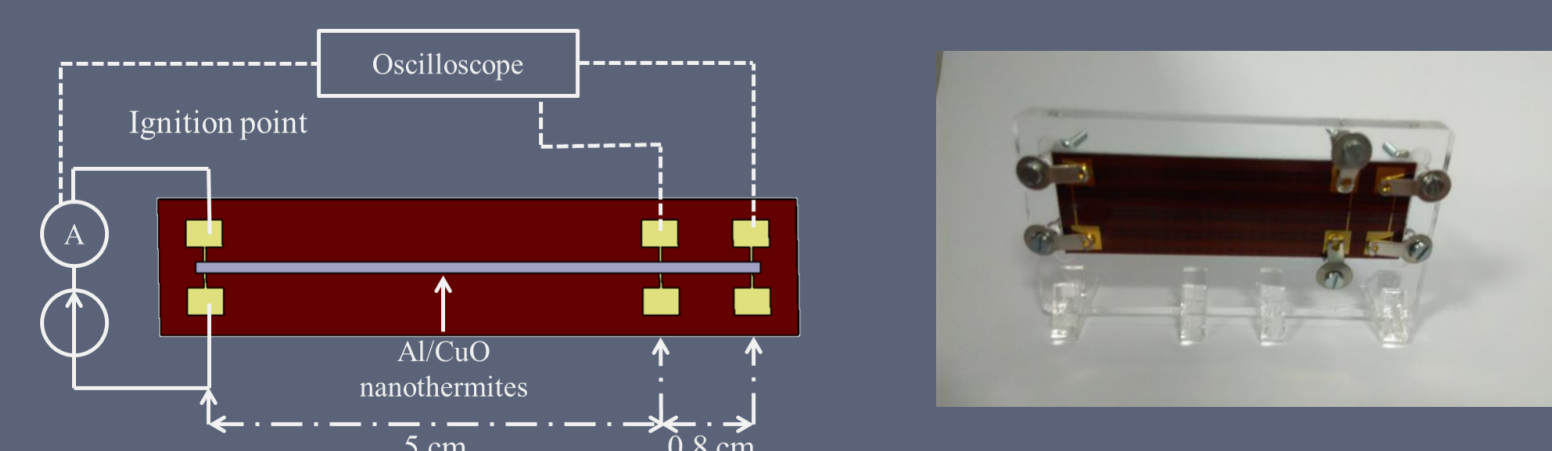

- Combustion velocity

Influence of the heating surface area

3 heating surface areas

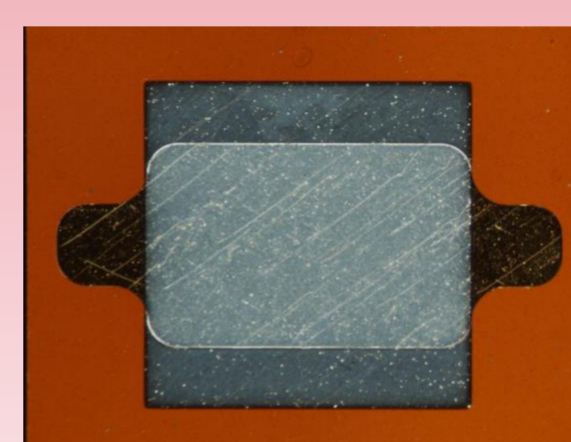

62%, 31% and 10% of the nanothermite surface area

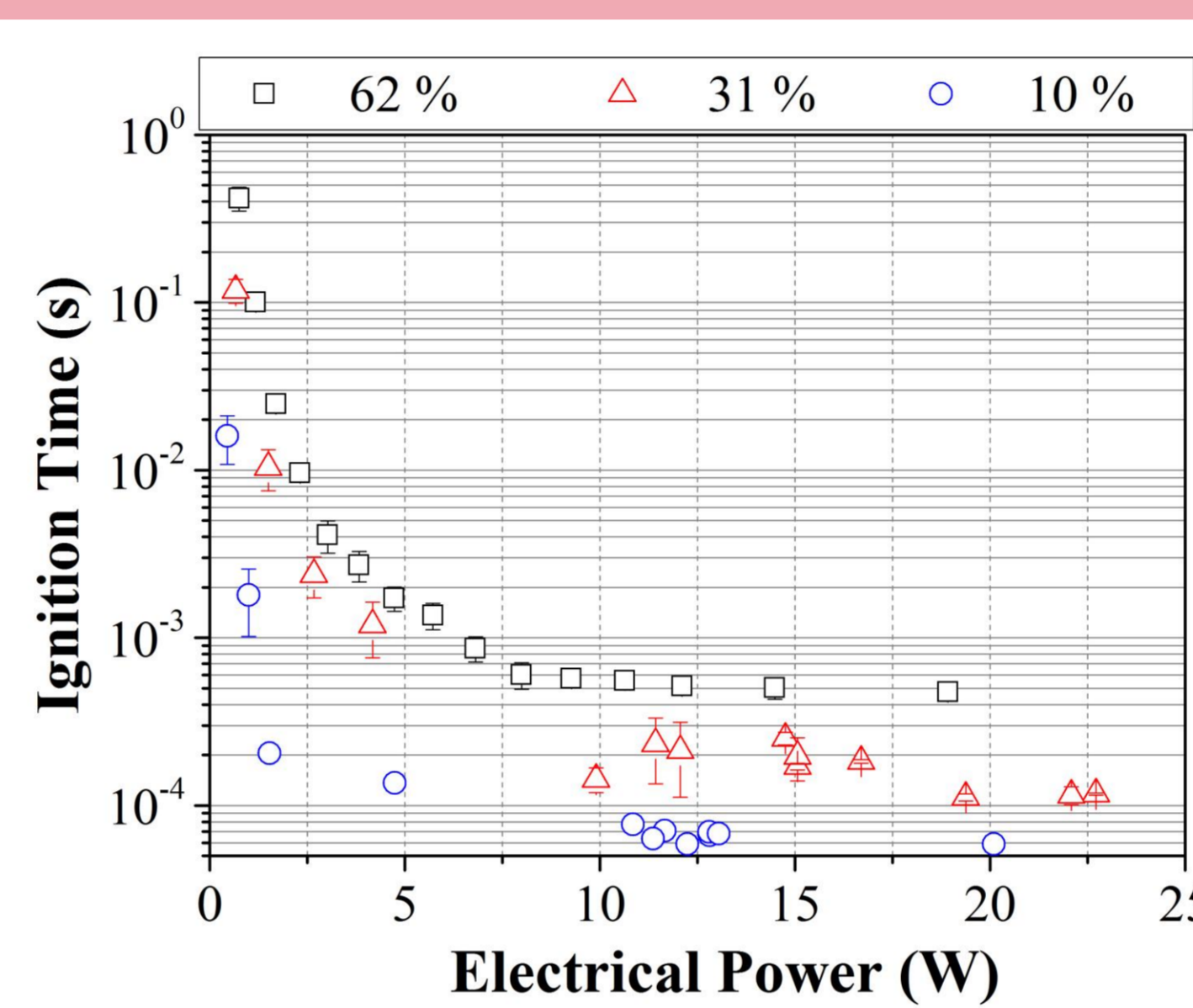

- Ignition time \searrow with \nearrow electrical power
- Minimum ignition time \searrow with \searrow heating surface area
- Fire/No fire condition \searrow by 41% when heating area divided by 4
- No change in the nanothermites reaction energy with electrical power and heating surface area because nanothermites volume is kept constant

Ignition time is reduced by 87 % with the heating surface area divided by 4.

Influence of the bilayer number

5, 10 or 15 bilayers of Al/CuO (200/100 nm)

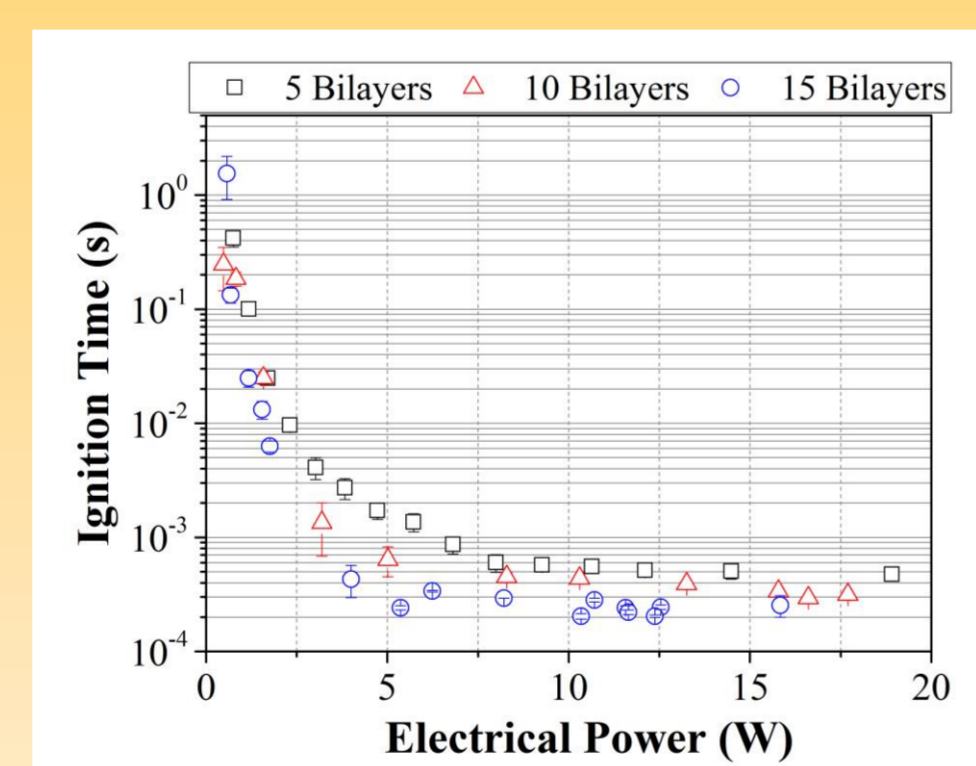
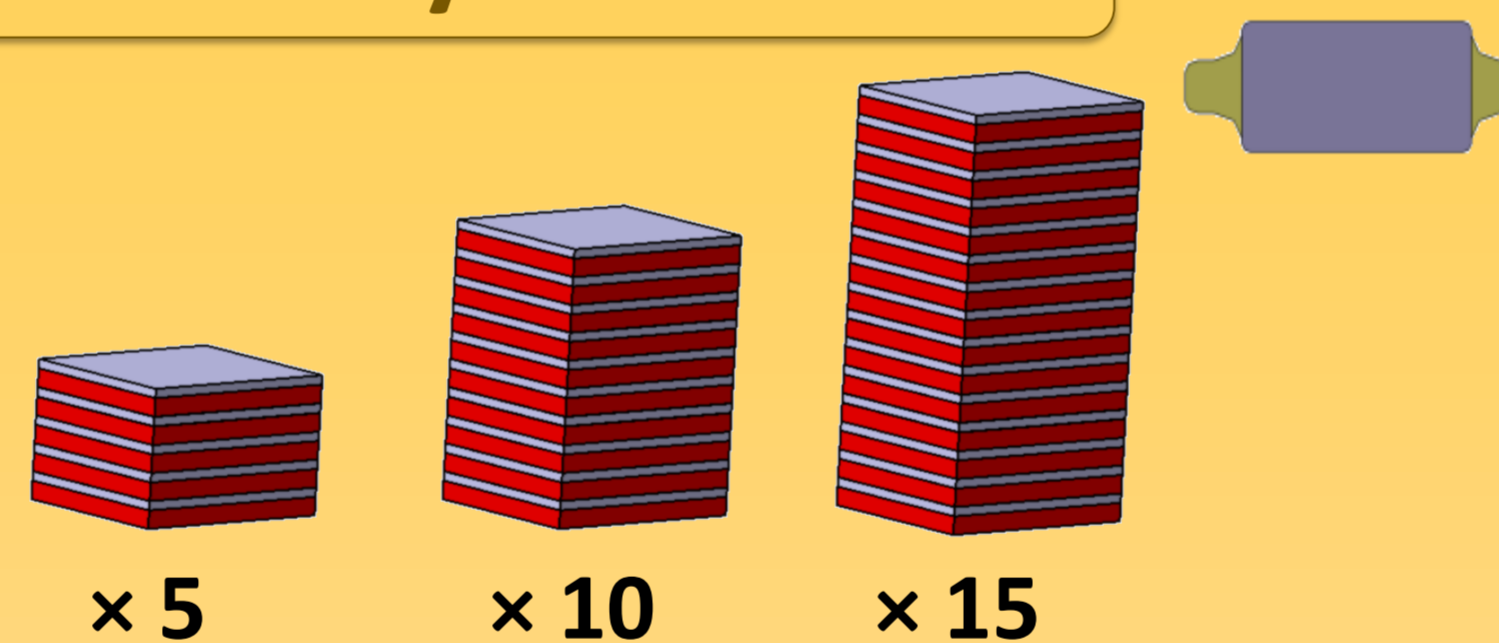

- Ignition time \searrow when bilayer number \nearrow
- Fire/No fire condition \searrow when bilayer number \nearrow

- Visible light intensity \nearrow when bilayer number \nearrow
- Integral of the photodiode signal \nearrow when bilayer number \nearrow

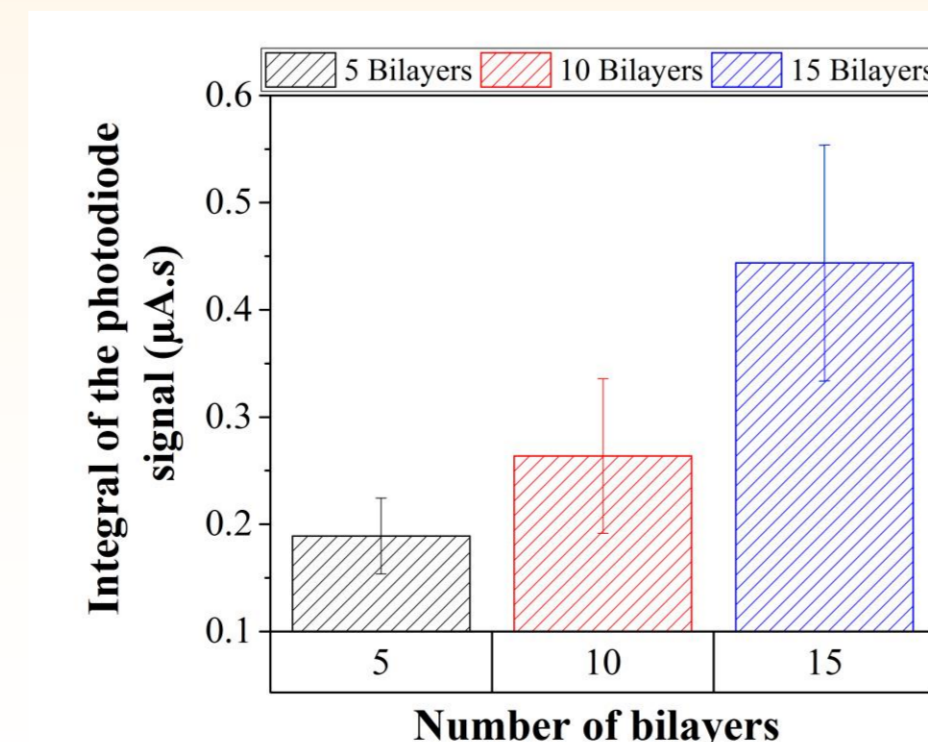
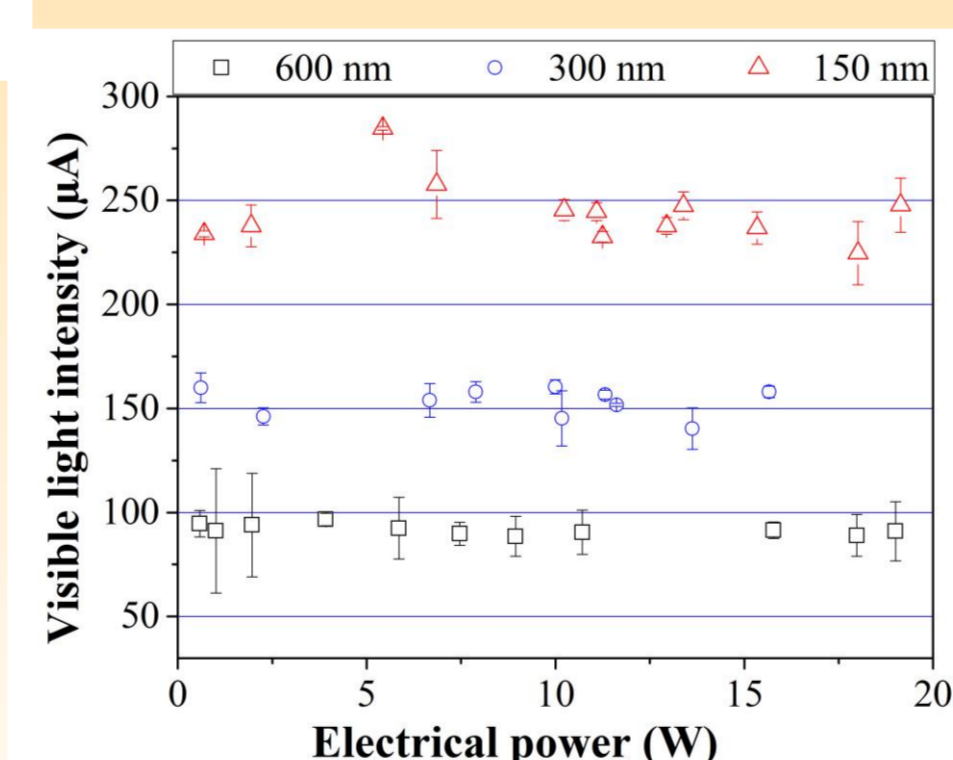

When bilayer number is tripled, ignition time is reduced by 96 % and the heat of reaction (integral of the photodiode signal) is multiplied by 2.35.

Influence of the bilayer thickness

Total thickness 1.2 µm
5 Bilayers

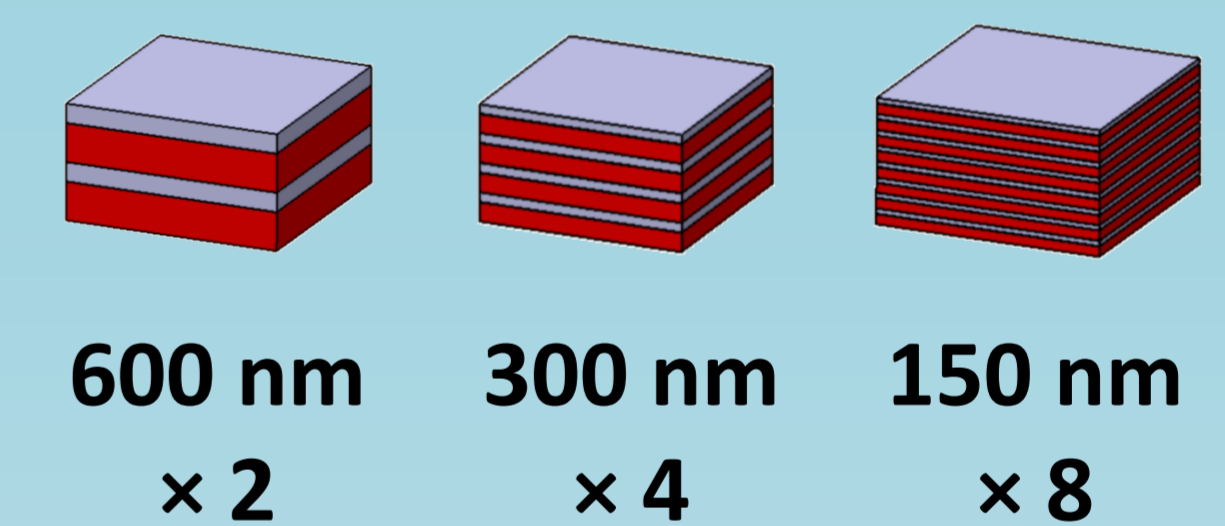

- Ignition time \searrow when bilayer thickness \searrow
- Fire/No fire condition \searrow when bilayer thickness \searrow

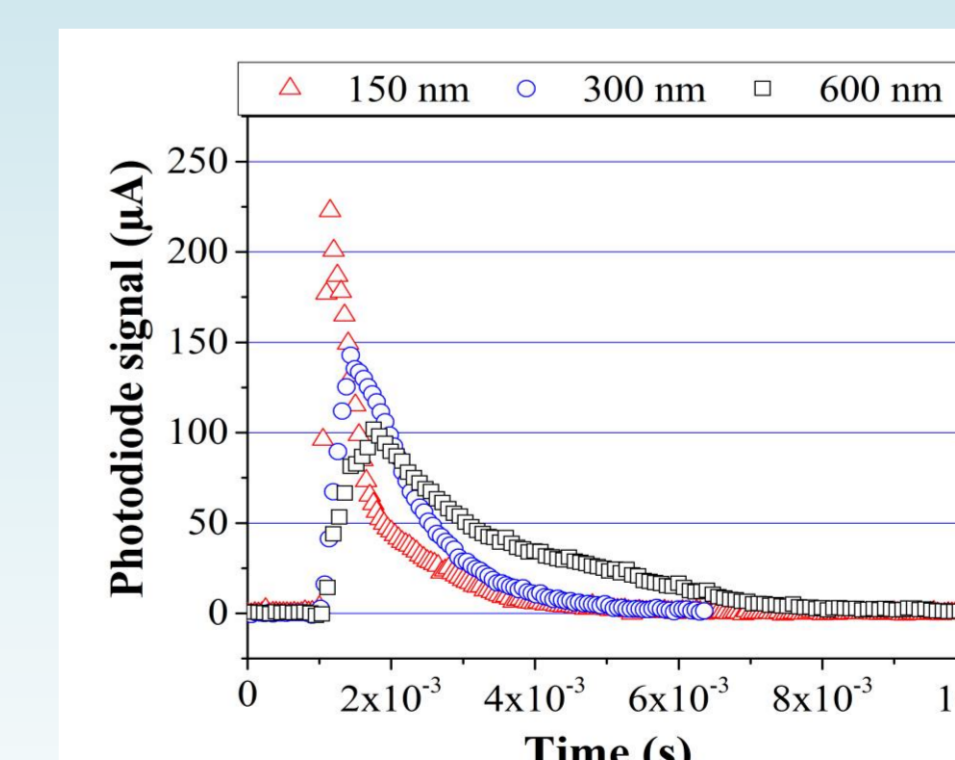
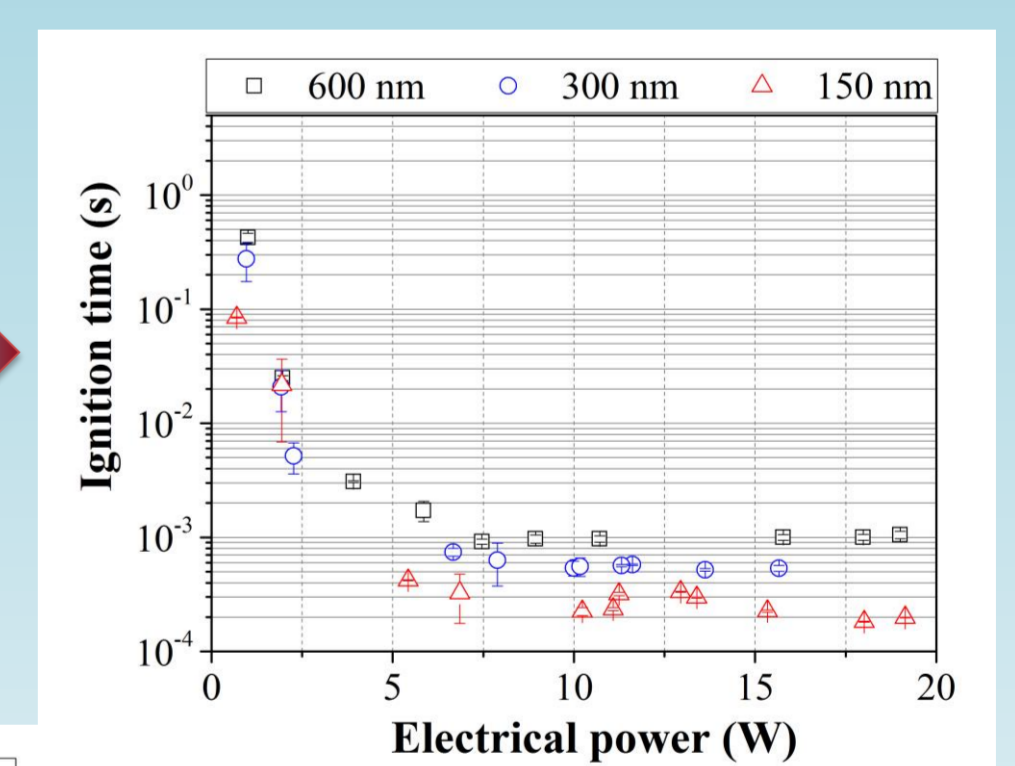

- Visible light intensity \nearrow when bilayer thickness \searrow but this does not affect the integral of the photodiode signal

Ignition time is reduced by 81 % when bilayer thickness is divided by 4.
Combustion speed multiplied by 2.46 when bilayer thickness is divided by 2.

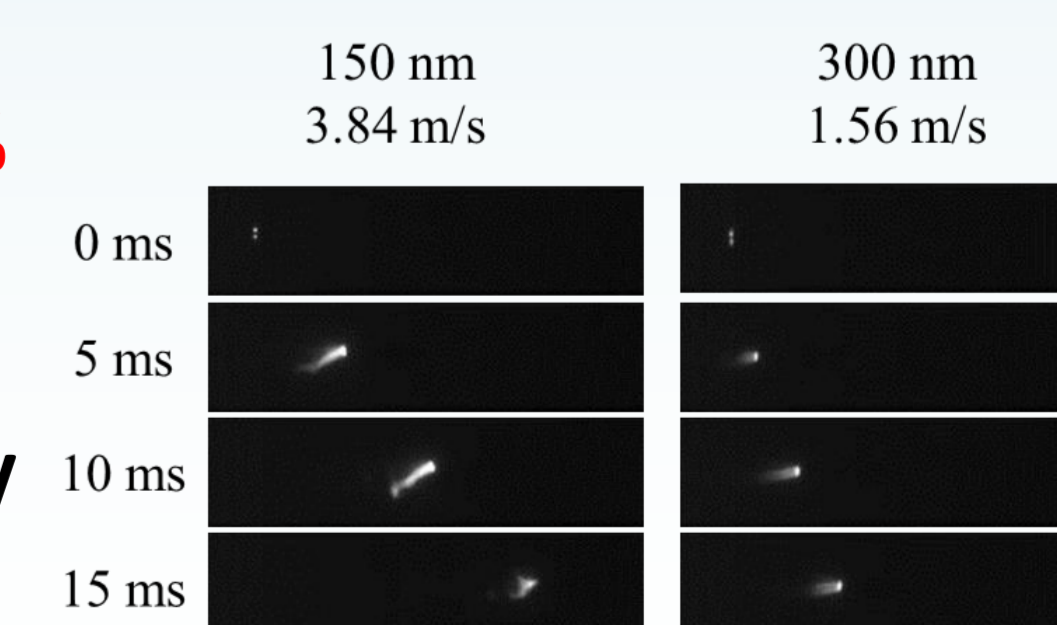

Conclusions

- Large influence of the heating surface on the ignition time.
- Number of bilayers influences ignition time and nanothermite reaction.
- Increasing the bilayer spacing increases the ignition delay since it decreases the reactivity of the nanothermites.

Aknowledgements

This work has been supported by the ANR grant IMPYACT (132497-LabCom2015), and European Project GATEONE.