



HAL
open science

Towards Intelligent Social Robots: Social Cognitive Systems in Smart Environments

Amir Aly, Sascha Griffiths, Verena Nitsch, Tadahiro Taniguchi, Stefan Wermter, Adriana Tapus

► **To cite this version:**

Amir Aly, Sascha Griffiths, Verena Nitsch, Tadahiro Taniguchi, Stefan Wermter, et al. (Dir.). Towards Intelligent Social Robots: Social Cognitive Systems in Smart Environments . 2017. hal-01683945

HAL Id: hal-01683945

<https://hal.science/hal-01683945>

Submitted on 24 Jan 2018

HAL is a multi-disciplinary open access archive for the deposit and dissemination of scientific research documents, whether they are published or not. The documents may come from teaching and research institutions in France or abroad, or from public or private research centers.

L'archive ouverte pluridisciplinaire **HAL**, est destinée au dépôt et à la diffusion de documents scientifiques de niveau recherche, publiés ou non, émanant des établissements d'enseignement et de recherche français ou étrangers, des laboratoires publics ou privés.

Proceedings of the Full Day Workshop

Towards Intelligent Social Robots: Social Cognitive Systems in Smart Environments

**in Conjunction with
IEEE Ro-Man
Portugal**

August 28, 2017

**Amir Aly, Sascha Griffiths,
Verena Nitsch, Tadahiro
Taniguchi, Stefan Wermter,
Adriana Tapus**

Towards Intelligent Social Robots: Social Cognitive Systems in Smart Environments

A “smart” environment represents the concept of the environment that incorporates intelligent systems (e.g., smart home, smart factory, smart city, etc.) employing heterogeneous devices, such as: sensors, actuators, cameras, networks, and screens. Within such a smart environment, robots can take on an important mediating role between human users and the environment if high-level cognitive functions and computational intelligence are employed to handle the uncertainty of the complex environment so as to allow agents to act appropriately within different contexts of interaction.

Using robots in smart environments opens the door to several socio-cognitive applications, such as: reducing cognitive load for individuals interacting with a smart environment, assisting the elderly and people with cognitive disabilities in mobility and daily tasks (which requires robots to learn the multimodal characteristics of human behavior and to spatially perceive the environment containing other smart objects so as to decide the best way to employ/manipulate them in order to successfully perform tasks), and developing a cloud-connected robot system to incrementally share knowledge between robots in different smart environments about the behavioral characteristics of human users in order to interact with them adaptively. To meet the requirements of these target applications, robots need to be able to learn how to use the capabilities of their smart environments so as to better address the needs of the human co-inhabitants.

The proceedings of this workshop included the following 3 contributed papers:

- 1- A. Wasik et al., **An Institutional Robotics Approach to the Design of Socially Aware Multi-Robot Behaviors.**
- 2- M. Kerzel et al., **Effect of a Humanoid's Active Role during Learning with Embodied Dialogue System.**
- 3- E. Dumont et al., **Robot and Ambient System Collaboration: An Ontology-Based Approach for Multi-User Activity Recognition Platform.**

In addition to a series of important keynote talks:

- 1- Prof. Alessandro Saffiotti: Making Social Robots Proactive.

2- Dr. Amit Kumar Pandey: Commercializable Use Cases of Social Robots and Some Key Building Blocks.

3- Prof. Friederike Eyssel: Social Robotics: Psychological Aspects of Successful Human-Machine Interaction.

4- Prof. Mohamed Chetouani: Interpersonal Robot Learning

An Institutional Robotics Approach to the Design of Socially Aware Multi-Robot Behaviors

Alicja Wasik, Alcherio Martinoli and Pedro U. Lima

Abstract—We propose an institutional robotics approach to the design of socially-aware multi-robot systems, where cooperation among the robots and their social interactions with humans are guided using institutions. Inspired by the concepts stemming from economical sciences, robot institutions serve as coordination artifacts, which specify behavioral rules that are acceptable or desirable given the situation and which can be replaced by other rules to enforce new acceptable or desirable behaviors without changing the robot’s core code. In this paper we propose a formal methodology for consistent design of coordinated multi-robot behaviors intended for use in human-populated environments. We illustrate theoretical concepts with practical examples. Graph-based formations serve as a basis for coordinated multi-robot behaviors and concepts from the literature on human-aware navigation provide social rules that are enforced by the institutions. Experiments are carried out in a high-fidelity robotic simulator to illustrate the application of the theoretical concepts.

I. INTRODUCTION

Multi-robot cooperative behaviors are becoming increasingly pervasive in real-world applications. To be socially aware, robots should use social norms devised by humans, which can differ from culture to culture. Existing methods allow for successful cooperation of multiple robots, but the human factor is often ignored or the person is treated as a moving obstacle. On the other hand, although human-aware navigation is a widely studied subject, only few studies discuss multiple robots behaving cooperatively in human-populated environments. Most works focus on human guidance, where strategies stem from early research on flocking herds [1], treat the group of humans as a particle [2] or assume that humans simply follow the robot [3]. Such solutions are largely oversimplistic. More realistic studies [4] ensure that the robots respect personal space of the humans. The state of research in human-aware navigation is largely mature in the single robot case. But when it comes to studies of cooperative multi-robot systems, the presence of a person is handled inappropriately or even naively, solutions are heuristic or difficult to generalize. Our intention is to provide a mechanism for abstraction of the underlying methods and to systematize and unify development of social-aware, multi-robot behaviors using the concept of institutions.

Supported by ISR/LARSyS Strategic Funds from FCT project FCT[UID/EEA/5009/2013] and FCT/11145/12/12/2014/S PhD grant.

Alicja Wasik and Pedro Lima are with the Institute for Systems and Robotics, Instituto Superior Técnico, Universidade de Lisboa, Portugal. alicja.wasik@epfl.ch and pal@isr.ist.utl.pt

Alicja Wasik and Alcherio Martinoli are with the Distributed Intelligent Systems and Algorithms Laboratory, School of Architecture, Civil and Environmental Engineering, École Polytechnique Fédérale de Lausanne, Switzerland. alcherio.martinoli@epfl.ch

The goal of Institutional Robotics (IR) [5] is to provide a strategy for specifying complex social interactions. Drawing inspiration from institutional economics, IR has been proposed with the aim to address the need for presence of coordination devices in multi-robot systems and to facilitate integration of robots in human societies. Since the robots controlled using the IR approach abide by the norms of institutional environments created by the humans, the collective performance during human-robot interaction is expected to surpass the existing methods. In the field of multi-robot systems, institutions have been introduced [5], formalized [6], used for modelling and implementation [7] of simple robotic behaviors. They also raised some interest in the social robotics community [8]. In [5] institutions are defined as artificial modifications that influence the collective order. Robot institutions are formally represented in [6] using Petri nets, which encapsulate the behavioral rules to execute a desired task and observe the specified social interactions. Validated in [6] in simulation and in [7] in real-world implementation, the institutional controller coordinates a swarm of 40 robots to maintain wireless connectivity. The predominant reason behind IR was to exceed the collective performance during human-robot cooperation. To the best of our knowledge, however, up to now IR has not been exploited to introduce the social aspect in multi-robot systems.

We propose a new methodology for development of socially aware multi-robot behaviors based on the IR framework. The new formalism allows us to deal with both high-level behavior management, such as decision making and planning, and low-level reactive coordination, such as formation control. Institutions introduce social rules inspired by human institutions that guide cooperation between the robots and result in mutual understanding between the robots and the humans. We focus on transparency and generality of the formalism, where its abstract representation allows for the use of miscellaneous robot behaviors and integration of social constraints of diverse nature. To illustrate the theoretical concepts, we apply the formalism to our work on robot formations [9], where we govern a graph-based formation behavior using one of the institutions. Proxemics [10] and social forces [11] form a set of social constraints that change the formation parameters (geometry, roles, trajectories). For realization of the robotic controller we use Petri Nets (PN).

This paper is organized as follows. Section II lists the aspects of social robot behaviors. The role of institutions in shaping such behaviors is described in Section III. An example of application is given in Section IV and the case studies are given in Section V. We draw conclusions in Section VI.

II. SOCIAL ROBOT BEHAVIORS

Consider a team of mobile robots deployed in environments populated with humans, such as museums or airports. The robots occasionally are required to perform a cooperative task without interrupting human activities and taking into account social rules. For instance, robots may be requested to guide a group of people, control the movement of the crowd, or temporarily block a passage. In order to do so in a socially aware manner, the robots need a basic understanding of the principles that govern human environments.

A. Behaviors and Actions

The tasks and functionalities that the robots may be required to perform are called *behaviors*, B . For the robot formation, the behaviors may include patrolling or human guidance. Behaviors are composed of basic building blocks - *actions*. *Individual actions* A_O do not involve social interaction, neither between the robots, nor between robots and humans. Actions that entail social interaction are *social actions* A_S . A set of all possible actions is $A = \{A_O \cup A_S\}$. B provides an ordering for the actions, it assures that the actions are executed in the correct order, sequentially or concurrently. More formally, $B_i \in B = (V, E)$ is a graph with the nodes V being the actions in A , $V : \{a \in A\}$.

B. Rules, Roles and Knowledge

When in a social situation, robots have to comply with the *rules* that govern human environments. Such rules include respecting personal space, giving a way at the door or passing on a right hand side of a corridor. The set of rules is an essential element directing behavior of the robots, rules directly encode social constraints and define what robot should and should not do. Rules R are operators on the set of actions that have the power to allow, forbid, select or modify the actions

Since the rules can allow and forbid actions, they decide what *roles* the robots can assume. When a robot plays a role, it is obliged to perform a set of actions assigned to this role and forbidden to take actions that are not permitted. Rules of the formation could allow the robot to take the role of a leader or a follower, or specify its decision making powers.

In order for the robot to comply with the rules, it must have *knowledge* about how to act according to the them. Types of information contained in the knowledge can range from parameters and data structures to complex algorithms. Stating that the rules can modify the actions means that the rules can change the parameters of the action, encoded by the knowledge. Knowledge K provides a common grounding for the robots, for the rules and actions to be based upon the same type of information. Common knowledge implies that every participant knows how to act, and knows that the others know how to act [12]. For the robots to navigate in a formation, they must know, among many others, each other's positions in the environment, what roles are assigned to whom and what it means to change formation shape from line to square. More importantly, the knowledge provides recipes for socially adequate interactions with humans. Thus,

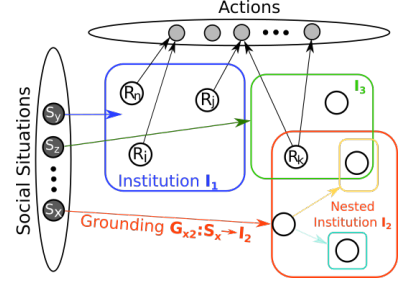

Fig. 1: Social situations activate the corresponding institutions, which, by evoking their rules, operate on the robot actions.

the knowledge incorporates the facts, beliefs and temporal information, as long as this information is imperative for the cooperation and interaction.

III. ROLE OF THE INSTITUTIONS

Common knowledge, common rules and roles known by all the robots are the pivotal concepts giving rise to socially aware behaviors. They reduce uncertainty, facilitate decision-making and promote cooperation, so that the cost of coordinating and other activities can be lowered [13]. They are the core of what is known in human environments as *institutions*. An institution can be regarded as a set of rules governing social interactions [14]. By sharing the institutional environment, the robots attain a good approximation of the situation and expectation that the others follow the same prescriptions enforced by the institutional rules.

A. Institutional Grounding

It has been said that the rules and the knowledge are the central parts of the institutions. Indeed, institutions encapsulate knowledge and the rules that correspond to a state of the environment and the participants (humans and robots) when a social interaction takes place. Such state is called a *social situation* S (action situation in [14]). An institution I is active during a specific social situation it has been designed for. Since one social situation may occur in different parts of the environment, involve various participants and have other dissimilar conditions, the robots must be able to recognize it. The process of recognition of a social situation and activation of the corresponding institution is called the *grounding*, $G : S \rightarrow I$. When a robot activates the institution, it becomes its *actor* and is obliged to act according to its rules. The institutional rules constrain robot actions differently depending on the social situations, robots do not need to reason about the rules and do not need to be reprogrammed every time they join a new instance of social situation.

B. Institutional Rules

A set of rules of institution I is an operator on a set of actions:

$$R_I : 2^{A_S} \rightarrow 2^{A_S} \quad (1)$$

The institutional rules map the social actions A_S according to a social situation, for which that institution is active (see Fig. 1). The rules of active institution can evoke, modify, or constrain the actions. Thus, when in a social situation, the robots engage in an *institutional behavior* B_I composed of nodes $A_I \subset A_S$ from a subset of social actions $V : \{a \in A_I\}$.

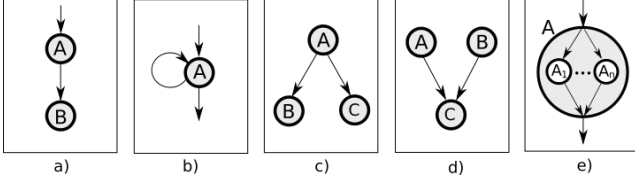

Fig. 2: Types of relations between the nodes of the RG.

As an example, consider a social situation when the robots are requested to guide a group of people. The robots are to approach the group, $a_{approach}$, inform humans that they will lead to a new location, a_{speak} , and move together with them, a_{guide} . Thus, the institutional rules would compose three actions, $a_{approach} \rightarrow a_{speak} \rightarrow a_{guide}$ sequentially.

C. Networks of Institutions

An *institutional environment* of the robot is composed of one or more institutions. A robot can be an actor of multiple institutions, it joins an institution upon recognition of a social situation and leaves an institution when the situation concludes. Activation of one institution can be a natural consequence of termination of another. Multiple institutions can be active simultaneously as long as the functioning of one institution does not interfere with the functioning of another. The order of the institutional environment is assured by defining how the institutions are allowed to interact. For this purpose, we propose *relational graphs*.

Definition 1. *Relational graph* (RG) is a directed graph defining the relationship between institutions present in the institutional environment of the robot. A node of the graph encapsulates the institutional behavior, $B_i \in B_I$, or an individual behavior $B_j \in B_O$. The edge linking two nodes defines the relation between them.

The relational graph is composed of the institutional behaviors B_I (which in turn are composed of social actions in A_S) and of the individual behaviors (composed of individual actions in A_O). The RG regulates which institutions can be active at a given time and assures that the actions of conflicting institutions do not run concurrently. Institutions can be *nested*, meaning one general institution can consist of several specialized institutions. According to its rules, the general institution can evoke one or a subset the nested institutions (see Fig. 1).

The RG is a mathematical behavior model used for forming dependencies between complex behaviors composed of multiple actions. As such, it can be readily used as the robot controller. The abstract definition of the RG allows for the use of a wide range of mathematical tools for building its representation. Most of the graphical modeling languages, including finite state automata, behavior trees, Petri nets and variations thereof are suitable for that purpose. Although the exact definition of the relations within RG depends on the choice of the modeling language, we provide an intuitive guide to building the network of institutions.

1) *Roles of the RG nodes:* Each node of the RG encapsulating the behaviors in B provides a high level compact representation of more complex compositions of actions. A

node is said to be active when at least one of the actions it contains is executing. Execution of the node can be instantaneous, continue for a finite amount of time or continue until it is ceased by an internal or an external event (similarly as an institution can be activated or terminated due to the social situation). Upon completion of the execution, the node triggers execution of its direct successors. After that it becomes inactive. The RG can be static or dynamic. Since, by the definition, the institutions are activated when the robot recognizes a social situation, it means that the robot must always perform an action of recognizing social situations. The outcome of this action triggers activation of the relevant institution (activates the B_I of that institution).

2) *Relations between the RG nodes:* Fig. 2 shows types of relations between the nodes of the RG. Fig. 2a) is a sequence. Fig. 2b) is a self-loop, where after being activated once, A is always active. Fig. 2c) is simultaneous execution. Note that B and C should not include actions that have a potential to interfere with each other. Node C in Fig. 2d) can only be activated after its predecessors (nodes A and B) have concluded their execution. Finally, node A in Fig. 2e) illustrates a nested institution, where internal rules of the general institution evoke a subset of specialized institutions. When A is activated, a subset of A_1 to A_n becomes active.

D. Creation, Evolution and Monitoring of Institutions

A human institution is a product of deliberate design or it arises spontaneously [13]. The creation of a robot institution is dictated by the presence of a social situation, while the desired outcome of using that institution is its *rationale*.

According to [15], rules of human institutions without obligatory sanctions are useless. Such rules are always monitored and enforced. Robots, as artificial agents, are not motivated to break rules, nor do they reveal opportunistic behaviors. However, sanctions and rewards given to the robots can help to regulate and monitor institutional environments, identify conflicting rules and inconsistencies. The sanctions and rewards for respecting or breaking institutional rules are the *payoffs* of the institution: $P_I = \{(sanction, reward) \forall r_i \in R_I\}$.

Robot institutions can be modified by cooperative decision making, or by an individual with a power to do so. Experience gained by the robots participating in a social situation can lead to gradual modification of the existing rules. For this to happen, the performance becomes a part of the institution and is stored in the *memory* of that institution: $M_I = \{(pm_1, \dots, pm_n) \forall B_i \in B_I\}$, where (pm_1, \dots, pm_n) is a set of relevant performance measures. In this way, the robots jointly contribute to evolution of the institution. More importantly, the rules remain consistent among the participants and retain the power to reduce the cost of coordination [14].

E. Institutional Formalism

The definition of institution is object of discussion among the economists, where the interpretation of institution, organization and rule is done according to the purpose they serve [16]. Similarly, the fields of IR, normative multi-agent systems [17] and computational organization theory [18]

operate on diverse definitions. Even within the field of IR, institutions are modeled dissimilarly among different research groups. Nevertheless, the core concepts, based on the economic theory, remain the same.

The definition of a robot institution we propose in this paper is not intended to be a general, one-size-fits-all solution. Indeed, we believe that similarly as in the social studies, robot institutions should serve their core purpose - of guiding social interactions.

Definition 2. *Institution* is a tuple

$$\langle ID, \text{Actors } T_I, \text{Knowledge } K_I, \text{Rules } R_I, \text{Behavior } B_I, \text{Actions } A_I, \text{Memory } M_I, \text{Payoff } P_I \rangle$$

This definition stems from political economy studies [12] conducted by Elinor Ostrom, winner of the Nobel Prize in Economics in 2009:

“Institutions can be defined as the sets of working rules that are used to determine who is eligible to make decisions in some arena, what actions are allowed or constrained, what aggregation rules will be used, what procedures must be followed, what information must or must not be provided, and what payoffs will be assigned to individuals dependent on their actions.”

In summary, *ID* is a unique identifier of the institution, composed of its *Name* and a *Rationale*, which states what the desired outcome of the institution is (why the institution is useful). *Actors* defines which robots are allowed to activate the institution, *Institutional Behavior* provides the ordering for the actions, while *Social Actions* are the recipes for performing the social actions, *Knowledge* describes what information the robot must possess in order for it to act, *Rules* allow, constrain or modify the actions, *Memory* retains robot experience. *Payoffs* are the rewards and sanctions for conforming or breaching the rules.

IV. APPLICATION OF THE METHODOLOGY: INSTITUTIONAL NETWORK FOR FORMATION BEHAVIORS

As a proof of concept, we apply the proposed formalism to our existing work on reconfigurable multi-robot formations [9]. The existence of socially adequate cooperative behavior relies on a few essential aspects that can be categorized as social situations. 1) *Situational awareness*. Robots are able to localize themselves in the known map, detect obstacles and distinguish humans. To establish a formation, robots need to know each other’s positions. 2) *Formation control*. Robots running the same formation control algorithm are capable of changing the formation shape and its connectivity. They avoid obstacles as a unit or individually. 3) *Human-robot interactions*. Robots are aware of the social constraints present in human environments and modify their behaviors in order to respect them. 4) *Global group objective*. A *virtual leader* (VL), provides the group objective, a trajectory, and communicates to the robots its virtual position. VL is perceived by all the robots as one of the team members and included in the formation algorithm as if it were a real robot.

We assume that the robots perform a default formation behavior, until the robots receive a task that involves interaction

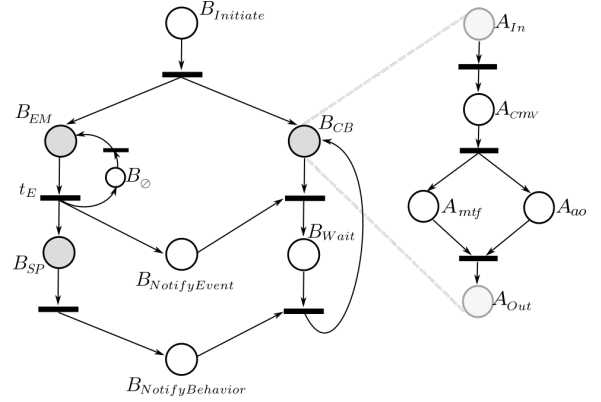

Fig. 3: The PN-based representation of the RG.

with humans, thus indicating a new social situation. Note that while moving in a formation, the robots interact with each other, so they are already situated in one social situation.

A. Institutions for Formation Behaviors

Given the above classification, the institutional network is comprised of four institutions:

1) *Environment Monitoring* I_{EM} : The I_{EM} assures that all the robots have means to build consistent world models. The actors of I_{EM} localize on the known map, communicate with the other robots and the virtual leader to obtain their positions and monitor for social situations. Upon recognition of a social situation, successor nodes of I_{EM} are activated.

2) *Collective Behaviors* I_{CB} : The I_{CB} offers the robots a common basis for understanding the specification of the formation behavior. By knowing and following the rules R_{CB} , each robot knows its role in the formation, the roles of the other robots and parameters of the formation, including shape, distances and connectivity.

3) *Social Planning* I_{SP} : I_{SP} is responsible for devising a social plan for guiding interactions with the humans. Only one actor can be active at any given time and we assume that the robot that recognizes the social situation first, activates I_{SP} . I_{SP} is a nested institution, it delegates control to specialized institutions. In our case studies, we will consider two specialized institutions, I_{SP}^B for a *blocking* task, and I_{SP}^{AC} for *accompanying* task. Knowledge of I_{SP} comprises of methods from the human-aware navigation literature, such as proxemics and social forces. According to the rules, the actor plans the behavior of the group, including the shape and path of the formation, so as to respect social constraints.

4) *Virtual Leader* I_{VL} : I_{VL} is run by one dedicated actor. I_{VL} involves a set of planning actions, responsible for interpretation of the task and planing the path, and execution actions, which simulate movement of the VL and broadcast its pose. Since the VL is perceived as one of the formation members, it guides the formation to achieve its objectives.

B. Relational Graph for Formation Behaviors

We use a Petri net-based representation of the RG. PNs are sufficiently general to model behaviors of extremely varying types, such as parallelism, concurrency and synchronization,

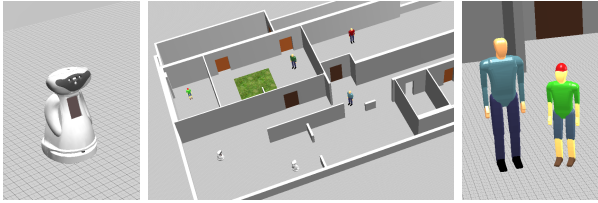

Fig. 4: The Webots simulator (Middle), the MBot robot (Left) and simulated models of child and adult (Right).

while providing a high degree of modularity. A gentle introduction to PNs can be found in [19]. The PN-based representation of the RG used for coordination of socially aware multi-robot behaviors is shown in Fig. 3.

The RG is composed of three nodes that represent institutional behaviors. B_{EM} that gathers information about current situation and B_{CB} that controls the formation are active by default. When one of the robots recognizes a social situation (passing control from B_{EM} to B_{SP} and $B_{NotifyEvent}$), it notifies all the team members to temporarily halt execution of the current behavior (deactivating B_{CB} and activating B_{Wait}). B_{SP} plans the new formation parameters according to R_{SP} and passes them to all the other robots in $B_{NotifyBehavior}$. The outcome of B_{SP} updates the knowledge of the I_{CB} , setting new formation parameters and the knowledge of I_{VL} , specifying a new task. Upon receiving the new parameters, the robots preempt B_{Wait} and resume formation in B_{CB} . Due to lack of space, we only show structure of one institutional behavior, B_{CB} . In B_{CB} the robot computes the motion vector in A_{CMV} , then it moves towards the desired place in the formation in A_{MTF} , while simultaneously avoiding the obstacles in A_{AO} .

V. CASE STUDIES

The aim of the case studies is to show diversity of the behaviors that the robots can engage in under the network of institutions. We illustrate two social situations, where interactions with humans are of two different sorts: in case A robots modify behavior of a person, in case B they adhere to the social conventions. The default behavior is formation patrolling and the RG graph serves as the robot controller. Experiments are performed in realistic simulator Webots [20] (Fig. 4), with holonomic MBot robots [21] developed within the FP7 European project MOnarCH (Multi Robot Cognitive Systems Operating in Hospitals) with the goal of introducing social robots in the pediatric wing of a hospital¹. The robots are equipped with navigation, perception and low-level safety sensors, accurately simulated and calibrated using real data. Robots self-localize using AMCL² from ROS.

A. Case Study I: Blocking

In the “blocking” task the robots influence behavior of the humans by blocking a specific passage. To execute the task, a minimum number of robots required to block the passage moves towards the designated space and assumes blocking positions. Upon receiving the “blocking” task, one of the

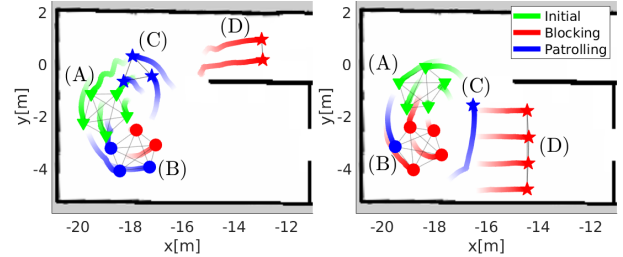

Fig. 5: Case Study I. Trajectories of the robots blocking narrow (upper) corridor and wide (lower) corridor.

robots becomes an actor of I_{SP}^{Bl} , a nested institution of I_{SP} . Knowledge of I_{SP}^{Bl} uses *social forces* model for predicting the behavior of the person when encountering a number of robots in the passage. Social forces reflect the psychological motivation behind the pedestrian behavior, they represent the influences of the environment and of the other pedestrians on the human motion [11]. There are two fundamental rules in R_{SP}^{Bl} : “Dispatch the minimal number of robots” and “Establish optimal blocking configuration”. According to R_{SP}^{Bl} , the actor of I_{SP}^{Bl} finds a minimal repulsive force, required to drive a person back from the area and the number of robots N_B and their configuration needed to generate that force. Furthermore, R_{SP}^{Bl} specify how to assign, which N_B robots engage in the blocking behavior, and which robots remain patrolling. The formation splits into two groups, and the virtual leader provides two trajectories, one for patrolling and one leading to the passage to be blocked.

1) *Results*: We performed two experiments with varied width areas to be blocked, (i) narrow and (ii) wide, each of five runs. In all experiments, five robots are patrolling in a pentagon-shaped formation, upon receiving a task, split into two formations with (i) $N_B = 2$ and (ii) $N_B = 4$. Trajectories of the robots are shown in Fig. 5, with the initial patrolling behavior (A), assignment of the robots upon splitting (B) and two formations performing patrolling (C) and blocking (D).

B. Case Study II: Accompanying

In the “accompany” task, the robots “accompany” a person that passes through part of the environment, at the same time respecting human comfort. Social norms, encoded in the knowledge of I_{SP}^{Acc} , are based on *proxemics*, a study of spatial separation that people naturally maintain between themselves and the others [10]. Proxemics serve to constraint motion of the robots by providing a minimal distance the robot should keep from a person. The associated rules R_{SP}^{Acc} state “Maintain a formation with the person” and “Do not enter personal space”, where personal space is a circle around the human, with the diameter depending on his age, gender and personality. The virtual leader guides the formation to the person and then, by imitating position of the human, seamlessly allows for including the human in the formation. R_{SP}^{Acc} specify the shape of the formation and the human-robot distances, proportional to size of the personal space.

1) *Results*: The accompanying behavior is illustrated in Fig. 6. Two robots wait until a person, child or an adult, enters the door (A), keep a triangle formation with the

¹MOnarCH, FP7, FP7-ICT-2011-9-601033 (<http://monarch-fp7.eu>)

²AMCL (<http://wiki.ros.org/amcl>)

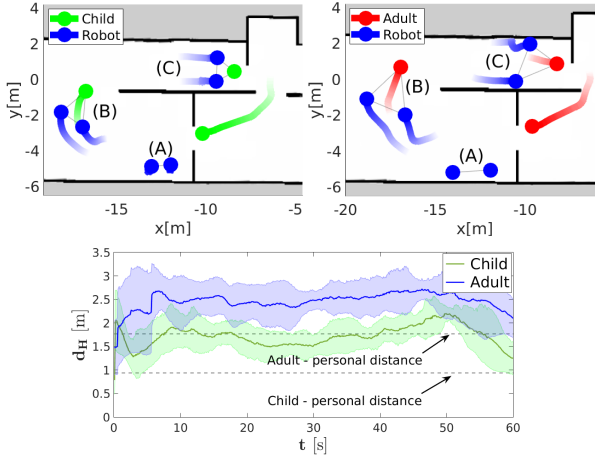

Fig. 6: Case Study II. (Top) Trajectories of the robots and the person. (Bottom) Average distances between the robots and the human.

human (B), and follow until the exit (C). In this example, the personal space of the child is $d_P^{child} = 0.94m$ and of the adult is $d_P^{adult} = 1.77m$. Fig. 6 (Bottom) shows the mean distances d_H between the robots and the human averaged over 5 runs. Since d_H is always above d_P^{child} for the child and d_P^{adult} for the adult, robots respect social space of the person by converging to a formation of appropriate size. The simple rules of I_{SP}^{Acc} allow for variability (parametrization) of the behavior according to the social context.

C. Discussion

The two presented case studies illustrated the degree of variability associated with multi-robot behaviors situated in a social context. The institutional approach allowed for incorporation of the social rules, often of inconsistent nature (such as proxemics or the social forces), in a unified methodology. Moreover, variability of the social norms existing among the individuals and among the cultures was reflected by adequate parametrization of the institutional rules. The proposed case studies illustrated only simple instances of social situations. How the robots recognize social situations and what perception capabilities are required are the topics of future work.

VI. CONCLUSIONS

In this paper, we proposed an institutional robotics approach to the design of socially-aware multi-robot systems, where cooperation among the robots and their social interactions with humans are guided by institutions. We introduced a formal methodology for the design of complex multi-robot behaviors conforming to social rules that govern human societies. A network of institutions provided means to impose social constraints on the robot behavior in a unified methodology. Formal definition of the institutions allowed for unambiguous specification of their purpose, responsibility, and consequences, as well as identification of the relational ties present in the institutional environments. As a proof of concept, we applied the formalism to our previous work on multi-robot formations. We presented a complete system composed of four institutions and defined the associations

among them. In two case studies we illustrated the diversity of the behaviors the robots can engage in under the network of institutions. By requiring the robots to engage with humans, we have shown that the institutions can govern social interactions according to well known methods, without the need to resort to case-specific heuristic solutions.

In the future work, we intend to gain further insight in the organization of human institutions to further improve the proposed concepts. We plan to evaluate our approach in more complex scenarios with multiple humans and perform test with real robots. As a vital part of our study, we will allow for modification of the institutional environment by the robots, investigating the idea of institutional evolution and learning.

REFERENCES

- [1] M. A. Potter, L. Meeden, and A. C. Schultz, "Heterogeneity in the coevolved behaviors of mobile robots: The emergence of specialists," in *Proc. of the 17th Int. Joint Conf. on Artificial Intelligence (IJCAI)*.
- [2] E. A. Martinez-Garcia, A. Ohya, and S. Yuta, "A multi-robot system architecture for trajectory control of groups of people," *Cutting Edge Robotics*, pp. 449–466, 2005.
- [3] S. Zhang and Y. Guo, "Distributed multi-robot evacuation incorporating human behavior," in *Asian Journal of Control*, vol. 17, pp. 34–44, 2015.
- [4] A. Garrell and A. Sanfeliu, "Cooperative social robots to accompany groups of people," *The Int. Journal of Robotics Research*, vol. 31, no. 13, pp. 1675–1701, 2012.
- [5] P. Silva and P. U. Lima, *Institutional Robotics*, pp. 595–604. Springer Berlin Heidelberg, 2007.
- [6] J. N. Pereira, P. Silva, P. U. Lima, and A. Martinoli, "Formalization, Implementation, and Modeling of Institutional Controllers for Distributed Robotic Systems," *Artificial Life*, vol. 20, no. 1, pp. 127–141, 2013.
- [7] J. N. Pereira, P. Silva, P. U. Lima, and A. Martinoli, "An experimental study in wireless connectivity maintenance using up to 40 robots coordinated by an institutional robotics approach," in *IEEE Int. Conf. on Intelligent Robots and Systems*, pp. 5073–5079, 2013.
- [8] S. Tomic, F. Pecora, and A. Saffiotti, "Too cool for school - adding social constraints in human aware planning," in *Proc. of the 9th Int. Workshop on Cognitive Robotics, CogRob (ECAI-2014)*, 2014.
- [9] A. Wasik, J. N. Pereira, R. Ventura, P. U. Lima, and A. Martinoli, "Graph-based distributed control for adaptive multi-robot patrolling using local formation transformation," in *IEEE Int. Conf. on Intelligent Robots and Systems*, pp. 1721–1728, 2016.
- [10] E. T. Hall, *The hidden dimension*. Doubleday & Co, 1966.
- [11] D. Helbing and P. Molnár, "Social force model for pedestrian dynamics," *Physical Review E*, vol. 51, no. 5, pp. 4282–4286, 1995.
- [12] E. Ostrom, *Governing the Commons: The Evolution of Institutions for Collective Action*. Cambridge University Press, 1990.
- [13] E. G. Furubotn and R. Richter, *Institutions and Economic Theory: The Contribution of the New Institutional Economics*. University of Michigan Press, 2005.
- [14] E. Ostrom, *Understanding Institutional Diversity*. Princeton University Press, 2005.
- [15] W. Kasper and M. E. Streit, *Institutional Economics*. No. 1582 in Books, Edward Elgar Publishing, July 1999.
- [16] G. M. Hodgson, "What are institutions?," *Journal of Economic Issues*, vol. 40, no. 1, pp. 1–25, 2006.
- [17] C. Hollander and A. Wu, "The Current State of Normative Agent-Based Systems," *Journal of Artificial Societies and Social Simulation*, vol. 14, no. 2, p. 6, 2011.
- [18] K. M. Carley and L. Gasser, "Multiagent systems," ch. Computational Organization Theory, pp. 299–330, MIT Press, 1999.
- [19] R. David and H. Alla, *Discrete, continuous, and hybrid Petri nets*. Springer Science & Business Media, 2005.
- [20] O. Michel, "Webotstm: Professional mobile robot simulation," *Int. Journal of Advanced Robotic Systems*, 2004.
- [21] J. Messias, R. Ventura, P. Lima, J. Sequeira, P. Alvito, C. Marques, and P. Carrio, "A robotic platform for edutainment activities in a pediatric hospital," in *IEEE Int. Conf. on Autonomous Robot Systems and Competitions (ICARSC)*, pp. 193–198, 2014.

Effect of a Humanoid’s Active Role during Learning with Embodied Dialogue System

Matthias Kerzel, Hwei Geok Ng, Sascha Griffiths and Stefan Wermter
Knowledge Technology Institute
Department of Informatics
Universität Hamburg
Vogt-Kölln-Str. 30
22527 Hamburg, Germany
Email:{Kerzel, 5ng, griffiths, wermter}@informatik.uni-hamburg.de

Abstract—When humanoid robots learn complex sensorimotor abilities from interaction with the environment, often a human experimenter is required. For a social companion robot, it is desirable that the learning can also be assisted by non-expert users. To achieve this aim, we present an embodied dialogue system which enables a humanoid to take on an active role during learning by guiding its user with verbal communication and through the display of emotions. We suggest an experimental setup for evaluating how the active role affects the learning result and the subjective evaluation of the humanoid by human participants.

I. INTRODUCTION

Humanoid robots are designed to operate alongside or together with humans in complex and unstructured everyday environments. In contrast to industrial robots, their tasks require adaptation to novel challenges that can be overcome through learning. State-of-the-art learning approaches, such as deep neural networks [1], [2], rely on a large quantity of training data. Apart from using costly human annotation, these data can be gathered through interaction with the environment [3]–[5]. Similar to a child, a humanoid can incrementally develop complex visuomotor skills through interacting in the physical world [6]. Due to their human-like appearance, humanoids can be assisted in this learning by non-expert users in a similar way these users would teach a child. This proposal of child-like learning for successful artificial intelligence goes back to Alan Turing [7]. Recent work, however, has shown that especially in teaching robots, people find it easier to teach a robot if it behaves similarly to a child [8]. Human assistance is often useful, as a humanoid occasionally needs help during the process, e.g. when objects roll off tables or are out of reach.

However, there are large differences between a child and a robot. While a child needs to develop all of its cognitive abilities, we can employ a mixed approach for a humanoid: some abilities develop through learning and interaction, other abilities are designed. Moreover, these capabilities can be used to enable an active role of the humanoid in learning.

In this paper, we present initial work on an embodied dialogue system that enables a humanoid to guide users through the training steps for developing visuomotor abilities, see Figure 1. We aim to evaluate the feasibility of the approach in guiding non-expert users to successfully collect training

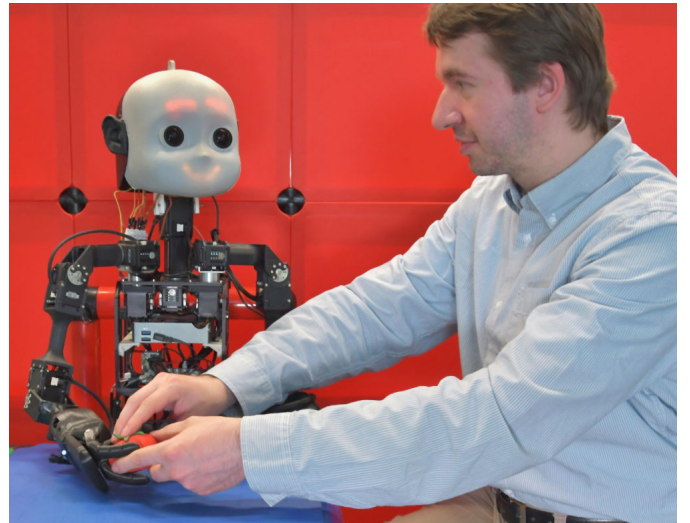

Fig. 1. A robot asks for help from a human assistant to learn grasping.

data and also to observe the effect of the active role of the humanoid with regard to the users’ subjective perception of the humanoid. By integrating a state-of-the-art approach for sensorimotor learning into our human-robot interaction (HRI) research, we increase the realism of the user interaction. Participants will take the role of a teacher of a physical robot in a real developmental task.

II. RELATED WORK

A. Learning Visuomotor Skills

Acquiring visuomotor skills with neural network approaches has gained interest in recent years. Mnih et al. [9] applied deep reinforcement learning for human-level control in computer games. Lillicrap et al. [10] extended the approach to continuous deep reinforcement learning for simplified robot arms in virtual environments. Neural reinforcement learning approaches rely on a large number of trial and error attempts to solve a task. They are successful in virtual environments, which can provide a large number of training samples in a short time at a low cost, both in terms of human supervision and damage to the robot (by wear or accidents).

When adapting neural learning approaches to physical robots, the time it takes the robot to perform actions becomes a critical factor. As shown by Gupta and Pinto [4], it takes a robot 700 hours of training to learn grasping positions and angles. For non-industrial robots, this long training time often exceeds the life-expectancy of hardware components. Levine et al. [3] and Kerzel and Wermter [5] suggest approaches for reducing the necessary training time by transforming the reinforcement learning into a supervised learning task. Both approaches rely on generating annotated training data, i.e. it is not learned through trial and error, but only from correct examples which leads to a shorter learning time. Levine et al. employ computation of forward kinematics to make the robot's state fully observable during training time. Kerzel and Wermter use the robot's ability to autonomously place objects to generate training samples. Though both of these approaches combine the advantages of mostly autonomous reinforcement learning with the short training time of supervised learning, both approaches ultimately rely on human experts for initiating the training and assisting the robot in case of errors.

Cruz et al. [11] have demonstrated that learning skills via accordances is improved by interactive learning versus regular reinforcement learning. Especially, speech and multimodal feedback are useful for adding interactivity to the learning process [12].

B. Spoken Dialogue Systems

Spoken dialogue systems (SDS) [13] are modules in HRI systems which receive speech as input and produce the corresponding replies [14]. An SDS solves five main tasks: Automatic Speech Recognition, Spoken Language Understanding, Dialogue Management (DM), Natural Language Generation and Text-to-Speech Synthesis [14]. In this paper, we focus on the integration of robot perception into the Dialogue Management to facilitate learning of visuomotor skills. DM is a decision-maker in SDS: It integrates information about the previous dialogue, internal states of the conversation agent, the robot's perception and agenda to decide on actions – which among others can be spoken utterances or motor actions. There are two main types of the dialogue systems: reactive and agenda-driven systems [15]. Reactive systems generate interactive responses based on what the user said with the purpose of producing a meaningful conversation. Agenda-driven dialogue systems do not produce output responses merely from the user's inputs but changes the context of the conversation to achieve its goals [15], which in our case is the realization of sensorimotor ability learning phases.

The variable and open-ended nature of language is now making data-driven methods more prominent in spoken dialogue systems [16] with deep learning approaches now also being explored [17]. However, state-of-the-art dialogue systems for HRI are often still built using a pipeline of tools and are mostly symbolic approaches to a large extent [18], [19]. Knowledge-based approaches are still efficient in restricted domains when data is not very variable [20] and the cost-benefit ratio of collecting and annotating data does not lend

itself to a data-dependent approach.

III. RESEARCH QUESTIONS AND EXPERIMENTAL SETUP

We aim to evaluate the effect of an active role during the learning of a humanoid robot that is assisted by non-expert users. In our experimental setup for grasp learning, a child-sized humanoid interacts with non-expert participants to learn sensorimotor skills for grasping. The grasp learning follows Kerzel and Wermter [5]: The robot interacts with an object on a table. It looks at, grasps and places an object repeatedly to gather samples for training its artificial neural architecture.

This learning process is only partially autonomous: Initially, the robot can move its hand to random positions on the table surface. Once the robot has an object in its hand, it places the object at a randomly chosen position and then associates the joint values during placing the object with how the scene looks after placement. Thus, the robot collects samples that link motor actions to visual inputs for developing hand-eye coordination. The robot, however, needs human assistance during the process: It only develops the ability to link its vision to its actions during training - it lacks this capability at first. Thus, a human assistant must initially place an object into the robot's hand. The robot will then begin its autonomous learning cycle of placing and picking up the object at random positions. However, it can happen that the robot accidentally moves the object during grasping or releasing. This leads to failed grasps where human assistance is needed.

We will realize the scenario in two conditions: In the *human-guided* condition, we will establish a baseline for non-active learning. A human experimenter will introduce the robot and the learning scenario, explain all the steps to the user, openly operate the robot by executing command-line programs and alert the user to situations that require assistance. To avoid influencing the participant, pre-recorded instructions in the same voice as used for the robot can be used. The robot will remain silent and perform the necessary actions for learning. It will however express emotions on its face to equalize the experimental conditions.

In the *robot-guided* condition, the robot will take on an active role: It will greet the participant and introduce the learning scenario; it will comment verbally on its actions and also use emotion expressions to indicate success or problems. All of the robot's actions will run autonomously, controlled by the embodied dialogue system. Both scenarios offer an authentic human-robot interaction based on a state-of-the-art neural deep learning approach. Our research is guided by three main questions:

- Does the embodied dialogue system enable non-expert users to undergo training with the humanoid? We will evaluate this objectively by comparing the number of successfully collected training samples in the *robot-guided* and *human-guided* experimental conditions.
- How comfortable and easy does the learning scenario feel to users? We will identify possible problems with a questionnaire and use this information to improve the

human-robot interaction and the learning scenario in future iterations.

- How does the humanoid’s active role in learning influence the user’s subjective perception of the robot? For this, we will employ the established GODSPEED test from Bartneck et al. [21] for both experimental conditions. We will compare these results to former studies that involved the same humanoid [22].

IV. NICO ROBOT AND GRASP LEARNING

We realize the experimental setup with NICO (Neuro-Inspired COmpanion), introduced by Kerzel et al. [23]. NICO’s child-like design is aimed to elicit a high user acceptance and make users intuitively adopt the role of a teacher.

NICO is primarily endowed with capabilities for human-like perception and interaction as well as object grasping and manipulation: Its two arms have six degrees of freedom and a human-like range of motion. NICO can grasp and manipulate small objects with its three-fingered hands. The fingers utilize a tendon mechanism which enables them to wrap themselves around objects of various sizes. Additionally, the state of tendons can be used as haptic feedback to evaluate if a grasping action has been successful.

NICO’s head can perform tilt and yaw movements; it features two cameras and two microphones. The child-like design of the head is adapted from the iCub [24]. The head features LED arrays around the mouth and eye regions that display stylized facial expressions [22].

A. Neural Grasp Learning

Visuomotor skills are acquired by associating a state of the environment with the desired action. In this paper, we follow the approach by Kerzel and Wermter [5], where the state of the environment is represented by images from the humanoid’s cameras and the action equals a joint configuration that moves the humanoid’s arm into a grasp position.

This association is facilitated by a deep neural network that can generalize from a limited number of training samples. The network architecture consists of two convolution layers that process input from the two cameras in the humanoid’s head and two dense layers that further transform this input into a joint configuration. The neural network is trained end-to-end, i.e. the training data consists of images and the output is the corresponding joint configuration for grasping the objects.

The training data is collected in a semi-autonomous training cycle, as shown in Figure 2. After the training object is placed in the humanoid’s hand, it moved to a random position on the table. The joint configuration that leads to this placement is memorized. The humanoid releases the object and moves the hand to the side to record images. These images are saved along with the memorized joint configuration to form one training data point. The humanoid then moves back to the memorized joint configuration to grasp the object again. If the grasp attempt was successful, the training cycle continues.

The approach takes advantage of the fact that placing an object is equal to the reversed act of grasping an object. A joint

configuration used to place an object can likely also facilitate grasping.

V. EMBODIED DIALOGUE SYSTEM

Moore [25] recently remarked that ”many roboticists regard a speech-enabled interface as a somewhat independent, bolt-on goody rather than a natural extension of a robot’s perceptuo-motorsystem”. This is to be viewed as problematic since it is much more advantageous to treat the language capabilities of a robot as part of the overall system and it is further much more in line with what is known about the role of language in humans. Feldman [26] indeed points out that language and cognition are best understood as a result of the brain being shaped for control of a physical body which navigates within a social world. However, this tighter coupling of the body, its control, and the dialogue processing system have not been fully explored in human-robot interaction research with respect to system design.

In this paper, an embodied dialogue system is implemented as a command center connecting all components that are involved in accomplishing visuomotor tasks. The Dialogue System is embodied as the decision-maker connecting each component together instead of being an independent module itself. The agenda-driven dialogue system guides the humanoid robot in achieving a goal, such as to test its grasping ability or to perform an object learning training. The goal is achieved by the joint-task agenda approach [15] in which tasks are accomplished by collaboration, combining effort from the humanoid robot and the user. The humanoid robot carries out its motor actions and reports its progress throughout the process while the user has hands the object to the robot upon request and provides assistance in case of errors.

The structured dialogue model is an effective model to be implemented in our goal-oriented dialogue system, as the states are atomic and finite, with its structure, position and information of each state fixed and domain-oriented [27]. The transition from one state to another is predefined, much like an if-else function: if object grasping is successful, perform action A; else, perform action B. This approach is useful in limiting the search space, thus increasing efficiency. Besides, the dialogue flow is controlled by restricting the flexibility. As the goal would require the humanoid robot to perform certain tasks in sequence, such as loading the neural network before getting joint values, implementing a finite state approach simplifies the interaction design.

As a decision-making module, the dialogue system embodies six components in performing tasks: Motion, Vision, Emotion, Computation, Knowledge and Natural Language Generation. The Motion component controls the sensorimotor ability of the humanoid robot such as moving the robot’s hand towards the object. The Vision component, the eyes of the humanoid robot, captures stereo images as inputs for the computation. The Emotion component shows facial expressions on the robot’s face using embedded LED lights, such as happy and sad expressions. The Computation component loads the trained model to the neural network and computes respective joint

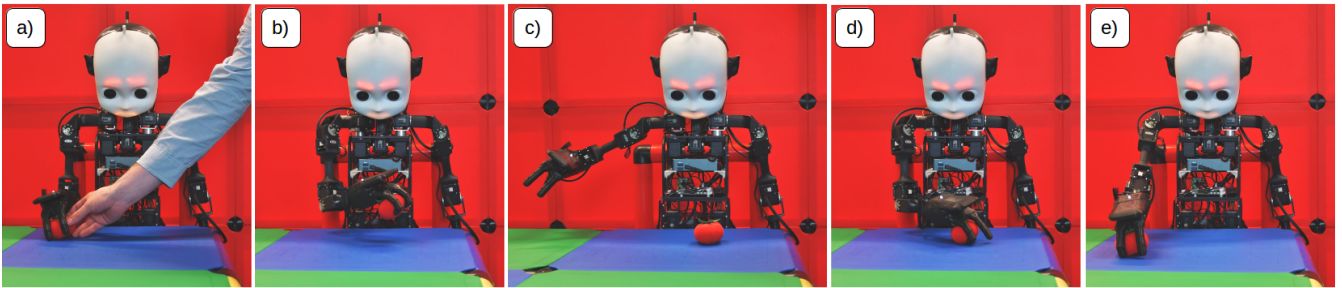

Fig. 2. Training cycle for grasping: a) A human experimenter places the training object in the humanoid’s hand. b) The humanoid moves the object to a random position on the table c) The humanoid places the object on the table and moves the hand away to records an image. d) The humanoid’s arm moves back to the last joint configuration to grasp the object again. Steps b) to e) are repeated to gather more samples.

values for grasping. The Knowledge component stores and provides information for the tasks, and the Natural Language Generation component outputs speech response to the user via text-to-speech synthesis. The Dialogue Manager is implemented using SMACH¹, a state machine library developed by ROS. The Motion and Emotion components are implemented using NICOmotion, a library to execute the NICO robot, developed by the Knowledge Technology team [23]. The Vision component uses a common USB protocol. The Computation component is a Convolutional Neural Network developed using Theano and Lasagne². The Knowledge component is build using PyKE³, a Python-based knowledge engine. The Natural Language Generation component is implemented using the Python Google Text-to-Speech library⁴.

Combining the components’ functionalities in a specific order for each task, the embodied dialogue system decides which action to perform next, according to which task it is currently doing and which input it has received. There are ten dialogue states for the system: *Control*, *Perception*, *Grasp*, *Fail*, *Success*, *NLG*, *Train*, *Relax*, and *Test*, followed by a *termination state* at the end (Figure 3). The *Control* state receives a command from the user and decides which task is to be performed by the humanoid robot among four available ones: test object grasping, train object grasping, release motor torques or load information. For example, if the train object grasping task is requested, the *Control* state executes the *Perception* state. In that state, the Motion component is called to move the robot’s hand and lower the head, followed by the Vision component to capture and save stereo images to file. The next state *Grasp* loads the pre-defined model to the neural network, computes joint values based on the stereo images and performs the motion of grasping. Depending on the grasp outcome, if no grasp object is detected, the *Fail* state is executed which passes a dialogue ID to the *NLG* state. On the other hand, if a grasp object is detected, the *Success* state is executed which passes a different dialogue ID to the *NLG* state. The *NLG* state maps the dialogue ID to the

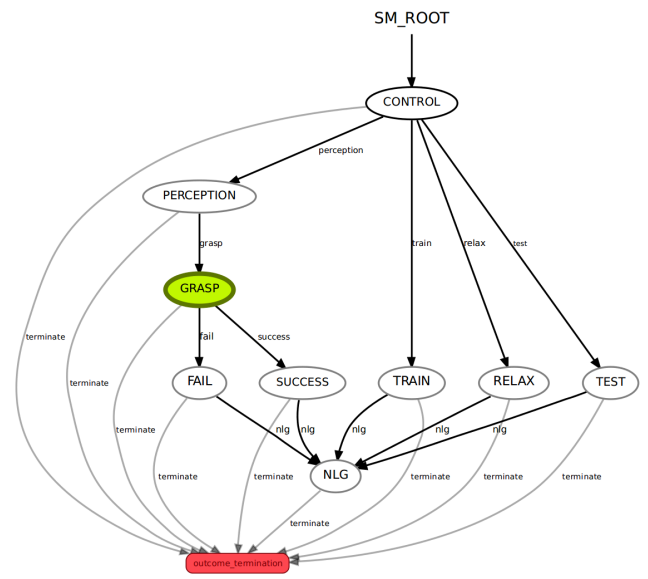

Fig. 3. Dialogue States for Object Grasping

respective sentence which is then conveyed to the user through speech using text-to-speech synthesis. The NLG function can be executed concurrently while another state is being executed, for the purpose of reporting progress without interfering with the executing action.

VI. EXPERIMENTAL PROTOCOL

A grasp-training task will be used to compare the effect of *robot-guided* and *human-guided* learning of a humanoid. After informing the participants about the experiment and gaining written consent, we will use a questionnaire to evaluate their previous experiences with robots. In the next step, the participants will be randomly assigned to one of the two conditions. The same protocol will be used for both the *robot-guided* and the *human-guided* learning conditions, with distinction in the way of interaction: in the *robot-guided* learning scenario, the robot will communicate with the user using Natural Language Generation, gaze, and display of emotions throughout the process whereas, in the *human-guided*

¹<http://wiki.ros.org/smach> [Accessed: 14.06.2017]

²<https://lasagne.readthedocs.io/en/latest/> [Accessed: 14.06.2017]

³<http://pyke.sourceforge.net/index.html> [Accessed: 14.06.2017]

⁴<https://pypi.python.org/pypi/gTTS> [Accessed: 14.06.2017]

Active robot-guided Scenario	Human-guided Scenario
I am ready to look. Please put the learning object onto the table for me. I am looking at the object. I have loaded the neural network. I computed the joint values. I am ready to grasp. I grasp the object. (success) Here you go, this is for you. (failure) Oh no, I failed to grasp the object. I will try again.	The robot is ready to look. Please put the learning object onto the table for the robot. The robot is looking at the object. The robot has loaded the neural network. The robot computed the joint values. It is ready to grasp. The robot grasps the object. (success) The robot lifts the object. (failure) Oh no, the robot failed to grasp the object. It will try again.

TABLE I
DIALOGUES FOR GRASP EVALUATION OF ACTIVE ROBOT-GUIDED AND HUMAN-GUIDED LEARNING SCENARIO

learning scenario, the same dialogue will be given by the experimenter to the user. Table I shows the dialogue for both scenarios. In the *human-guided* condition, the robot will not engage in dialogue interaction with the participant. Other than that, both conditions will have the same steps:

1) *Step 1*: The learning phase begins by handing the training object to the humanoid: The humanoid’s hand moves to the starting position and opens. The participant is asked to

place the training object into the hand. The humanoid then closes its hand and places the object in a random position on the table. Upon placing the object, the robot moves its hand away from the table to capture pictures. The hand is then moved back to re-grasp the object and continue the training cycle. As described in section IV-A, the learning phase is mostly autonomous after the participant has initially handed the training object to the robot. Should an error occur, like the training object falling off the table or being shoved away during grasping, the participant is alerted, and instructions are given to hand the object back to the humanoid before the training is resumed. In the *robot-guided* condition, the humanoid uses haptic perception to detect failed grasps, moves its head to an upright position to face the participant, displays a sad face, and requests help. In the *human-guided* condition, the experimenter stops the training cycle and instructs the participant to hand back the object. The learning phase lasts for 10 minutes; we use a fixed time to evaluate how many samples are collected in this time frame.

2) *Step 2*: Next, the participant is asked to evaluate the learned visuomotor skills by placing the training object repeatedly in front of the humanoid. The participant is truthfully informed that the evaluated sensorimotor skills were trained in the same way as in the learning phase, but more samples were necessary and thus an already trained neural model is used. After the participant places the object on the table, the humanoid looks down and records images. Using its neural network, the robot processes these images to compute joint values for grasping. In the *robot-guided* condition, the humanoid differentiates successful and failed grasps. It reacts accordingly by looking up, displaying a smiling face and offering the object to the participant, or by looking up and making a sad face, see Figure 4. In the *human-guided* condition, the robot lifts its hand regardless of the success of the grasp. Table I shows the dialogue for the *robot-guided* and *human-guided* conditions. This phase lasts for 5 minutes.

3) *Step 3*: Finally, the participant is asked to evaluate both the interaction and the humanoid. To evaluate the interaction, a specialized questionnaire is used. The humanoid is evaluated with the GODSPEED questionnaire [21]. Participants are asked to rate the humanoid on 24 five-point scales between pairs of opposed adjectives, e.g. artificial vs lifelike. The items cover the five categories anthropomorphism, animacy,

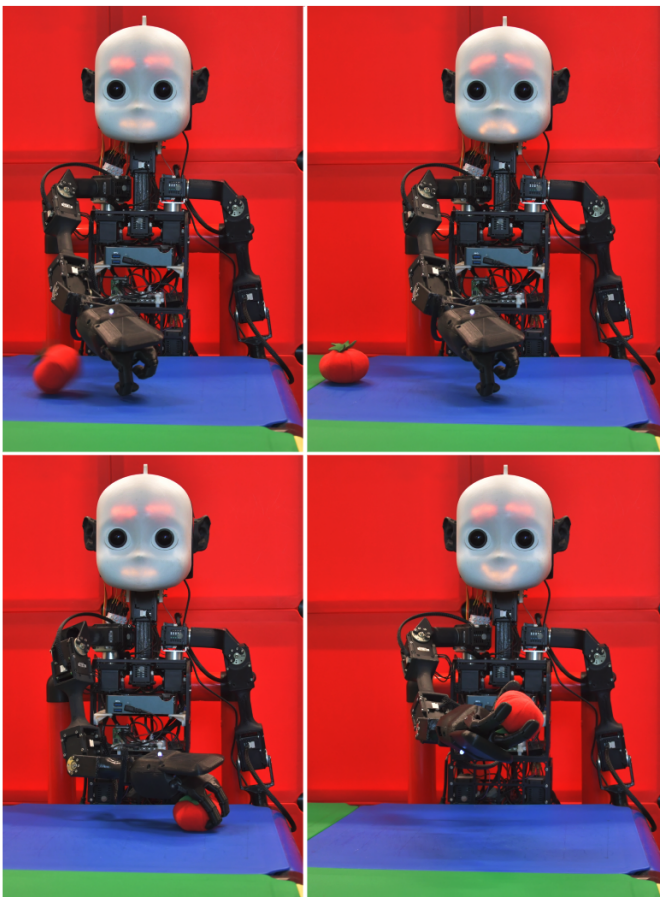

Fig. 4. Top: Failed grasp attempt; the humanoid displays a negative emotion to alert the human interaction partner. Bottom: Successful grasp attempt; the humanoid displays a positive emotion and offers the object to its interaction partner.

likeability, perceived intelligence, and perceived safety. After the experiment, participants are debriefed.

VII. CONCLUSION AND FUTURE WORK

We aim at researching the effect of an active role in learning of a humanoid robot. We want to evaluate how well a learning scenario that is solely mediated by the humanoid works, how well users accept such a scenario and how the robot's active role in learning influences the participant's perception of the robot. To answer these research questions in a principled way we designed and realized an experimental setup. We chose the child-sized humanoid NICO [23] which, due to its appearance, should enable participants to easily adopt the role of a teacher. NICO's arms have a human-like range of motion, which enables it to manipulate an object in front of the body. A haptic sensing mechanism in the hands informs the robot of successful grasp attempts. NICO can display emotion on its face to further enhance the human-robot interaction.

We employ a state-of-the-art approach for visuomotor skill acquisition based on deep neural learning to increase the authenticity of the scenario. The participants will train the robot using the same way it has been trained by researchers. All system components are integrated into an embodied dialogue system that not only handles the verbal interaction with the user but also uses knowledge about the learning progress and haptic sensing to control a multimodal interaction that includes physical actions and display of emotions.

In future work, we will evaluate the active learning humanoid against a baseline scenario where a human experimenter instructs the participants to assist a robot. We will use the insights gained from this study to improve the entire experimental setup, ranging from the robotic hardware to the embodied dialogue system.

ACKNOWLEDGMENT

This work was partially funded by the German Research Foundation (DFG) in project Crossmodal Learning (TRR-169) and the Hamburg Landesforschungsförderungsprojekt CROSS.

REFERENCES

- [1] J. Schmidhuber, "Deep learning in neural networks: An overview," *Neural networks*, vol. 61, pp. 85–117, 2015.
- [2] Y. LeCun, Y. Bengio, and G. Hinton, "Deep learning," *Nature*, vol. 521, no. 7553, pp. 436–444, 2015.
- [3] S. Levine, C. Finn, T. Darrell, and P. Abbeel, "End-to-end training of deep visuomotor policies," *arXiv preprint arXiv:1504.00702*, 2015.
- [4] L. Pinto and A. Gupta, "Supersizing self-supervision: Learning to grasp from 50k tries and 700 robot hours," in *Robotics and Automation (ICRA), 2016 IEEE International Conference on*. IEEE, 2016, pp. 3406–3413.
- [5] M. Kerzel and S. Wermter, "Neural end-to-end self-learning of visuomotor skills by environment interaction," in *International Conference on Artificial Neural Networks (ICANN)*, 2017 accepted.
- [6] A. Cangelosi and M. Schlesinger, *Developmental Robotics: From Babies to Robots*. MIT Press, 2015.
- [7] A. M. Turing, "Computing machinery and intelligence," *Mind*, vol. 59, no. 236, pp. 433–460, 1950.
- [8] A.-L. Völlmer, M. Mühlh, J. J. Steil, K. Pitsch, J. Fritsch, K. J. Rohlfing, and B. Wrede, "Robots show us how to teach them: Feedback from robots shapes tutoring behavior during action learning," *PLoS one*, vol. 9, no. 3, p. e91349, 2014.
- [9] V. Mnih, K. Kavukcuoglu, D. Silver, A. A. Rusu, J. Veness, M. G. Bellemare, A. Graves, M. Riedmiller, A. K. Fidjeland, G. Ostrovski *et al.*, "Human-level control through deep reinforcement learning," *Nature*, vol. 518, no. 7540, pp. 529–533, 2015.
- [10] T. P. Lillicrap, J. J. Hunt, A. Pritzel, N. Heess, T. Erez, Y. Tassa, D. Silver, and D. Wierstra, "Continuous control with deep reinforcement learning," *arXiv preprint arXiv:1509.02971*, 2015.
- [11] F. Cruz, S. Magg, C. Weber, and S. Wermter, "Training agents with interactive reinforcement learning and contextual affordances," pp. 271–284, Dec 2016. [Online]. Available: <https://www2.informatik.uni-hamburg.de/wtm/publications/2016/CMWW16/>
- [12] F. Cruz, G. I. Parisi, J. Twiefel, and S. Wermter, "Multi-modal integration of dynamic audiovisual patterns for an interactive reinforcement learning scenario," *IEEE*, pp. 759–766, Oct 2016. [Online]. Available: <https://www2.informatik.uni-hamburg.de/wtm/publications/2016/CPTW16/>
- [13] D. Gibbon, R. Moore, and R. Winski, Eds., *Handbook of standards and resources for spoken language systems*. Berlin: Walter de Gruyter, 1997.
- [14] D. Griol, Z. Callejas, R. López-Cózar, and G. Riccardi, "A domain-independent statistical methodology for dialog management in spoken dialog systems," *Computer Speech & Language*, vol. 28, no. 3, pp. 743–768, 2014.
- [15] P. Piwek, "Dialogue with computers: dialogue games in action," in *Dialogue across media book*, ser. Dialogue Studies, J. Mildorf and B. Thomas, Eds. Amsterdam: John Benjamins, 2017, vol. 28.
- [16] H. Cuayhuilit, "Simpleds: A simple deep reinforcement learning dialogue system," in *Dialogues with Social Robots*, K. Jokinen and G. Wilcock, Eds. Singapore: Springer, 2017, pp. 109–118. [Online]. Available: http://link.springer.com/chapter/10.1007/978-981-10-2585-3_8
- [17] R. T. Lowe, N. Pow, I. V. Serban, L. Charlin, C.-W. Liu, and J. Pineau, "Training end-to-end dialogue systems with the ubuntu dialogue corpus," *Dialogue & Discourse*, vol. 8, no. 1, pp. 31–65, 2017.
- [18] A. Perzyl, S. Griffiths, R. Lafrenz, and A. Knoll, "Generating grammars for natural language understanding from knowledge about actions and objects," in *Proceedings of the IEEE International Conference on Robotics and Biomimetics (ROBIO)*, Zhuhai, China, December 2015, <http://youtu.be/mgPQevfTWP8>.
- [19] M. Eppe, S. Trott, and J. Feldman, "Exploiting deep semantics and compositionality of natural language for human-robot-interaction," in *Intelligent Robots and Systems (IROS), 2016 IEEE/RSJ International Conference on*. IEEE, 2016, pp. 731–738.
- [20] S. Griffiths, F. A. Eyssel, A. Philippsen, C. Pietsch, and S. Wachsmuth, "Perception of artificial agents and utterance friendliness in dialogue," in *Proceedings of the 4th International Symposium on New Frontiers in Human-Robot Interaction at the AISB Convention 2015*. The Society for the Study of Artificial Intelligence and Simulation of Behaviour, 2015.
- [21] C. Bartneck, D. Kulić, E. Croft, and S. Zoghbi, "Measurement instruments for the anthropomorphism, animacy, likeability, perceived intelligence, and perceived safety of robots," *International journal of social robotics*, vol. 1, no. 1, pp. 71–81, 2009.
- [22] N. Churamani, M. Kerzel, E. Strahl, P. Barros, and S. Wermter, "Teaching emotion expressions to a human companion robot using deep neural architectures," in *2017 International Joint Conference on Neural Networks (IJCNN)*, May 2017, pp. 627–634.
- [23] M. Kerzel, E. Strahl, S. Magg, N. Navarro-Guerrero, S. Heinrich, and S. Wermter, "NICO – Neuro-Inspired COmpanion: A developmental humanoid robot platform for multimodal interaction," in *Proceedings of the IEEE International Symposium on Robot and Human Interactive Communication (RO-MAN)*. IEEE, 2017 accepted.
- [24] G. Metta, L. Natale, F. Nori, G. Sandini, D. Vernon, L. Fadiga, C. von Hofsten, K. Rosander, M. Lopes, J. Santos-Victor, A. Bernardino, and L. Montesano, "The iCub humanoid robot: An open-systems platform for research in cognitive development," *Neural Networks*, vol. 23, no. 8–9, pp. 1125–1134, 2010.
- [25] R. K. Moore, "From talking and listening robots to intelligent communicative machines," in *Robots that talk and listen*, J. Markowitz, Ed. Berlin: de Gruyter, 2015, pp. 317–335.
- [26] J. Feldman, "Embodied language, best-fit analysis, and formal compositionality," *Physics of Life Reviews*, vol. 7, no. 4, pp. 385–410, 2010.
- [27] D. Schlangen, "Modeling dialogue: Challenges and approaches," *Künstliche Intelligenz*, vol. 3, no. 5, pp. 23–28, 2005.

An Ontology-based approach for Robot and Ambient System collaboration

Emmanuel Dumont^{1,2}, Dan Istrate¹ and Mohamed Chetouani²

Abstract—In activity recognition, sensor based errors or uncertainties induce a wrong statement in the environment representation. To overcome these issues we introduce our ontology-based approach where a system, based on a mobile robot and an ambient system, is able to generate collaborative tasks when necessary to recognize activities. Using two ontologies to represent the environment, inconsistencies are detected and high level data are exchanged between both systems to correct and clarify ambiguous description of the environment. This process allows to generate adequate clarifying tasks by explicitly including knowledge and capabilities of each system. We expose our approach in two experiments where interaction between both systems are mandatory to respond a human "find an object" request in a first scenario and recognize multi user activities in a second scenario.

I. INTRODUCTION

Robotic and ambient systems are more and more involved to improve wellness and health condition. Usability and acceptance of robotics approaches for Ambient Assisted Living are increasingly getting investigated [1]. In the field of Active Assisted Living (AAL), ubiquitous systems are employed and, sometimes, hardware limitations or uncertainties in data processing induce wrong statement and inaccurate decision (i.e. a blind spot on a mobile robot or a low confidence presence detection in a security system). To overcome those issues, several systems, such as robots and ambient systems in a cloud robotics networks, can be used in parallel to complete and reinforce each other environment representation [2], [3].

In activity recognition, robots or ambient systems are widely explored ([8]-[12]) combination of these systems, as proposed by Hu in [4], are getting investigated through smart environment and cloud robotics. In this paper, we introduce a ROS-based interactive platform including a mobile robot and an ambient system, integrating connected objects and sensors developed by several companies. Based on knowledge, perception and action capabilities, the platform generates adequate collaborative tasks using ontology based representation. From a user point of view, the interaction between the robot and the ambient system is transparent, (i.e. asking to the robot or the ambient system to find an object does not change the outcome of the scenario). In accordance with [5], we name "system of systems" this transparent global structure composed of the ambient system and the mobile robot.

In [6], a human and a robot interact together to find objects. The robot is able to handle ambiguities (i.e. more than one object fulfills the given description) using an ontology approach. Knowledge representation over an ontology grants a formal naming and description of the classes (Object, Human, Sensor, etc.), attributes (spatial, temporal and physical properties), and relationships between everything that physically or fundamentally exists in an environment allowing a formal context representation. An ontology grounds the sensed physical world with natural language, making the comparison of different types of sensors, and thus different types of information in a system, easier. Moreover communication between a system and a human is also facilitated as an information comes with its context [7]. Finally defining in an ontology offline classes, properties and relationships, and using this ontology as an online semantic, thus human readable, data collection allow to infer and reason on the stored knowledge, i.e. defining a property "A *recognized human is in the same room as the sensor used to recognize him*" will automatically infer, when a human is detected by a camera, "This human is in the same room as the camera". Thereby, from a basic online extracted information and the offline defined properties, an environment representation can be described.

II. RELATED WORK

Our work is based on the recent advancements in cloud robotics network and activity recognition. It relates on a collaboration between a robot and an ambient system, both able to detect and clarify inconsistencies in their environment representation. We tend to recognize activities with this system of systems and exploit a collaboration mechanism to perform tasks. Consequently, [8]-[10] introduce ambient systems composed of a wide set of sensors to recognize ADL. Tapia in [8] designed a system for complex activity recognition using "tape on and forget" state-changes sensors placed on doors, sinks, light switches, etc. This work demonstrates that pervasive simple sensors can be used to recognize activities. Storf is able in [9] to monitor and extract typical behavior of older person. The system detects deviation by employing a range of ambient and non intrusive sensors. Van Kasteren in [10] recorded a dataset in a house where 14 state-change sensors were installed on doors, cup-boards, refrigerator and a toilet flush sensor. Each activities were annotated by the subject. Probabilistic models are employed to determine features for each activity in order to detect them during future experimentation. Xia in [11] present a framework and algorithm to recognize ADL from the robot's

²Laboratoire de BioMecanique et BioIngenierie UMR 7338, University of Technology of Compiègne, 60200 Compiègne, FRANCE

¹Institut des Systemes Intelligents et de Robotiques ISIR UMR 7222, University of Pierre and Marie Curie, 75005 Paris, France
emmanuel.dumont@isir.upmc.fr

point of view. Two datasets (one using a humanoid robot and one with a non-humanoid robot) for egocentric robot activity recognition recorded were registered and analyzed.

Compared with probabilistic approaches, ontologies based modeling are adjustable and can be easily customized and scaled up during initialization and in use situation. Chen in [12] introduce an ontology-based approach; considering sensors, objects and activities; to model, represent and infer the current user's activity. Whereas Riboni in [13] propose to combine statistical inferencing and ontological reasoning to recognize ADL.

Finally, an interaction between a robot and an ambient system is introduced by Hu in [4]. These two systems perform a task of user identification: A pervasive camera indicates users' position to the robot able to navigate and identify them. Waibel in [14] introduces a platform where multiple robots are connected. Each robot collects data during the execution of a task and share them with others to improve the overall task performance using a simple learning algorithm. Manzi in [15] proposes a cloud robotic architecture where an assistive robot gets data from worn sensor to localize a human in an apartment. Flexibility in a smart environment facilitates the user acceptance. Amato in [16] designed a smart environment composed of a robot and an ambient system able to adapt itself to a new environmental and/or user condition.

The contributions of our paper are the implementation of a platform where a mobile robot and an ambient system collaborate, when mandatory, to achieve simple activity recognition tasks. Currently, we do not aim to recognize Activities of Daily Living (ADL). However as this platform will tend to recognize them, we emphasize some features of the system using a basic activity recognition scenario in 3. An ontology-based data collection approach is used to clarify ambiguities, by exploiting data exchanges between the two environment representations.

III. SYSTEM DESIGN AND KNOWLEDGE REPRESENTATION

The system of systems is composed of a robot and an ambient system. Both interact and collaborate with each other in order to fulfill a proactive or human-requested task. In this section, we describe the way the environment representation is stored and shared.

A. Architecture

In our work, the robot and the ambient system, have their own perception environment. The global architecture is detailed in the figure 1. Software wrappers have been developed under the ROS middleware for each family of sensors integrated. They process received data (such as images, low level numerical values, etc.) and extract similar features (i.e. face detection and recognition, location of a detected movement, etc.) regardless of the platform on which they are integrated. A data manager software is used to update the ontology and manage exchanged data (*Request*) with the other system using a simple TCP/IP communication over WiFi. The server/client implemented in the data manager

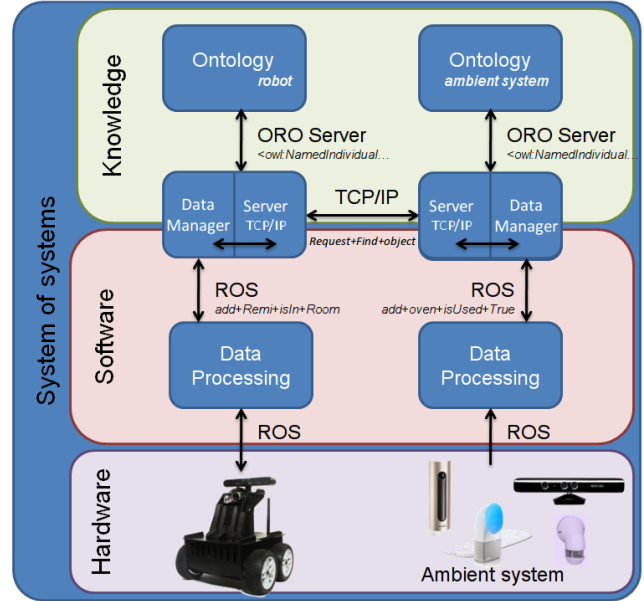

Fig. 1. Overview of the architecture

exchanges requests and data between the two systems. When a server receives a request, it transfers the received payload to the data manager by publishing in the adequate topic. Then the demand is processed and the answer (which contains information) is relayed to the client via the server.

Any extracted information is stored semantically in an ontology using the open source ORO platform [17]. "ORO relies on a dialect of RDF, OWL Description Logic, which is the decidable part of OWL". ORO functionalities include to insert (*Add*) or delete (*Remove*) facts (i.e. RDF¹ triples), to look up for concepts (*Find*) and check consistency: each time a data is added in an ontology, ORO checks if an inconsistency occurs. The communication protocol between ORO and the data manager uses another TCP/IP protocol, the ontologies are updated by executing standard SPARQL queries from ORO. The key benefits of this framework are 1) the simplification of expression statement in the ontology compared to the SPARQL queries. 2) Ontology reasoning with Pellet [18] on the high level data collection combined with the predefined properties, builds up the corresponding system environment representation in real time. So when a statement is added in the ontology using ORO Server, the ontology consistency is checked each time: a safe "add" option, provided by ORO, allows to safely add a statement in the ontology and check the consistency using Pellet. If the resulting ontology is inconsistent, ORO removes this statement and send back an error message. When a system adds an information in the ontology via ORO, this safe "add" command is employed. If an error is raised, a clarification process is initiated.

The mobile robot uses the ROS navigation stack for autonomous path planning and Simultaneous Location And

¹Resource Description Framework, <https://www.w3.org/RDF/>

Mapping (SLAM). Before the scenario, a map of the apartment is created using the map service proposed by Xaxxon and implemented on ROS. Each room and point of interest is manually labeled on the map as a "waypoint" which corresponds to a Cartesian position on the map. Moving to a specific destination, such as a table, corresponds to navigate to the specified waypoint.

The ambient system is composed of industrial sensors: Infrared sensors, used as movement detection to indicate active human presence in a room (*unknown_human1 isIn Bedroom*) and power consumption sensors, to specify if an electric device (oven, microwave, TV) is turned on (*kitchen hasAn-Activated oven*) both from Legrand, a Welcome camera, from Netatmo able to detect and recognize faces. Data are retrieved and updated in the ontology every minute (*human1 isIn livingRoom*), some Kinect devices from Microsoft used as RGB cameras for color detection and face recognition (*human1 isIn livingRoom, redObject isIn bedroom*), a sleeping connected object "Aura" from Withings indicates only if someone is sleeping every five minutes (*unknown_human1 isSleepingIn bedroom*). Each sensors were provided with an API. ROS wrappers were developed to be able to update and nourish the ontology.

The mobile robot is an Oculus Prime platform from Xaxxon. This robot is composed of a microphone, an RGB camera, a loudspeaker and an Orbbec Astra depth camera. In both systems, a new sensor or connected object with a provided Application Programming Interface (API) can be easily included just by developing a ROS wrapper to ensure data compatibility in the ontology.

B. Knowledge Representation

Data representation can be done at two levels. Low level data (signals) reflect the sensed environment and can only be compared to an alike low level data (a sound can only be compared to another sound to recognize it). Robotic and ambient systems are limited when a low level data comparison is processed: stored data have to come from the same kind of sensors which implies that both systems share the same sensors architecture. High level data (here semantic data) represents a normalized information, i.e. presence of a recognized human, here the human recognition could have been done using a voice recognition, a face recognition or any human recognition method and thus, does not depend on the sensors, thereby the ambient system and the robot does not need to share the same kind of sensors. We chose to collect semantic high level data in an ontology to be able, using its already defined properties, to process a more complex information. A more complex information is an imbrication of several high level data i.e. the activity *cooking* can inferred from the information of the activation of the oven and the presence of someone in the kitchen.

In this subsection, a formalization of the environment representation is done for the robot and the ambient system using semantic, regardless from which sensor the information is extracted.

1) *Classes, Properties and inference*: The ontology used is slightly inspired from the *OpenRobots Common Sense Ontology* [17]. Classes represent the basic concepts of the apartment environment *Objects* (*Bed, Oven, etc.*), *Sensors* (*Camera, Microphone, etc.*) or *Systems* (*Robot or Ambient system*). Spatial properties are defined and spatial chained properties are set up (i.e. a chain of object properties between *isIn* and *isNextTo*: *human1 isNextTo Bed, Bed isIn Bedroom* implies *human1 isIn Bedroom*).

Activity recognition is a more complex high level of data. They are established as a triplet [Human hasActivityIn Location] in the ontology and need to be inferred from other collected data and a chain of object properties (i.e. the two statement "*kitchen hasActivated oven*" and "*human1 isIn kitchen*" infer the next triplet *human1 isCookingIn kitchen*; or if the human has not been recognized for the moment but sensors detects someone is sleeping in the bed: *unknown_human1 isSleepingIn bedroom*).

2) *Spatial Knowledge*: When two humans exchange information about the localization of an object, relative position are employed "on the living room table", "close to the computer", etc. When two systems exchange information about the localization of an object, absolute and relative position in a space can be employed when the same perspective is shared. However ambiguities arise when a system cannot take the perspective from another point of view, i.e. an overhead camera has not the same point of view as an embedded camera on a robot. Here, some specific objects, which are not supposed to move daily (bed, tables, sofa, etc.), are set up in every ontology during initialization. When exchanging spatial knowledge, a global perspective point of view is adopted and relative properties are used:

[Object] isIn [Room]. An object or a human is detected in a specific room. This object property is functional "for each individual x, there can be at most one distinct individual y such that x is connected by *isIn* to y"². In other words, a first statement "*human1 isIn aRoom*" and the statement "*human1 isIn anotherRoom*" will lead to an inconsistency of the ontology so that, *human1* can only be in on room at a time.

[Object] isOn [Object]. An object, or a human, is on another object when a sensor detects the first one where a stationary known object should be (i.e. a bed, a sofa, etc.).

[Object] isNextTo [Object]. An object, or a human, is next to another human or object when the applied metrics between them is small.

3) *Ontology Fusion*: During the achievement of a task by a system, inconsistencies or uncertainties may occur during the feature extraction. In this paper, to clarify a situation means to detect that an inconsistency or an uncertainty occurred in a system. The system in question requests to the other to complete or correct the raised problem by sharing knowledge about a set of data. Here, this interaction, which consists of an exchange of data between the two systems, can be done if each system's environment representation

²See www.w3.org/TR/owl2-syntax/#Functional_Object_Properties

is semantically stored in its ontology and if necessary sets of data are shared during a clarification process. In term of software implementation, when a system request to the other an information, the request is immediately treated: the information is sought in the system ontology and if found, sent back to the requester. If not found, the ambient system will answer that *"nothing is found"* whereas the robot will seek for the missing information. An information always depends on a location, i.e. *"Is there someone in the bed ?"*. For each location there is a corresponding waypoint on the robot's map so that the robot can navigate to this point autonomously. For every system, when a new request is received during the process of the previous one, it is put in a queue (FIFO), and will be put out when the previous request will be completely treated.

IV. USE CASE SCENARIOS

In the previous section, we proposed an architecture allowing two systems to represent their environment. This paper focuses on a smart environment working with a mobile robot to achieve tasks they cannot do alone. This section analyzes two main situations where interactions between the systems are mandatory: a system seeks for a missing information in its ontology ; a system adds an information in its ontology which leads to an inconsistency. We present two scenarios selected to address these issues and report the resulting interactions. Figures 2 and 3 describe the interactions between the ambient system and the robot that occur when one of the system cannot find any required information to fulfill a task.

A. Scenario 1: Cooperation between the ambient system and the robot to find an object

In this scenario the cooperation between the ambient system and the robot is tested in a task where a human requests and asks to the robot to bring him/her to a specific object. Here, the robot and the ambient systems does not have any sensor alike (color detection is only integrated in the ambient system), moreover, the robot initially has no information on the object and no way to get some by itself. So, both systems must collaborate, by exchanging information, to find the object and reach the goal. Those interaction are totally transparent for the user which does not know if the robot is able or not to achieve alone the requested task.

The first step, as described in the figure 2, consists to launch the system and set up the goal *"Find and reach the red object"* which is, here a red-colored object. This object is on a table in sight range for the ambient system's RGB camera. In the second step, after initialization, the ambient system, using its RGB camera, extracts the relative location of the asked red object *:(Object isIn bedroom and Object isOn table)* then pushes corresponding data into its ontology. The robot, pulls everything about the red object from its ontology. As the robot has no cameras and cannot find it using its other sensors, nothing is found (cameras used for color detection purpose are only integrated in the ambient system; by default the robot has its own depth cameras only used, here, for a

navigation purpose). As no information of the object was found in the robot's ontology, it requests information about the object to the ambient system. From the ambient system point of view, as the robot is not seen by the camera, giving him the object's absolute coordinates would mean nothing for it as the perspective of the two systems are different and thus, the necessary Cartesian system is not common for the two systems. However, the room and position of some objects like the table have been set up initially in each system. So, stored data *(Object isIn bedroom and Object isOn table)* in the ambient system's ontology can be exchanged and directly stored in the robot ontology as such.

The data just harvested by the ambient system are transferred to the robot which, in turn, updates its ontology. At this point, the two ontologies contain the same data concerning the object. The robot is now able to locate the object and navigates as close as possible to its position on the table, so as close as possible to the table. Finally, when the table is reached, the robot interacts with the human by indicating *"The object is here"* with its loudspeakers.

B. Second scenario: Activity recognition

In this scenario the ambient system and the robot try to recognize humans activities in an apartment. The experiment takes place in a domestic environment where three people have an activity: the first one (H1) is sleeping in the bedroom, the second one (H2) is in the sofa watching TV, the third one (H3) is in the kitchen cooking. Following ethical rules, cameras are not installed in rooms where privacy should be preserved. Thus, cameras and microphone, including those which equip the robot, are banned in the bedroom, toilets and the bathroom.

For each human, three data are permanently assessed by the system of system $\{Identity; Location; Activity\}$. As previously mentioned, the objective for the two systems is to collaborate to recognize activities and to have in the ontology: *H1 isSleepingIn bedroom, H2 isWatchingTVIn livingRoom, H3 isCookingIn kitchen*. However, this goal cannot be reached as the sleeping human cannot be identified due to the ethical rule.

Moreover, at the beginning of the experiment in the ambient system, H2 and H3 are voluntarily mixed up in order to observe an ambiguous situation where one person is detected in two different rooms.

The ambient system is composed of two RGB cameras (one set up in the living room, one set up in the kitchen), a power consumption sensor and the Aura sensor in the bed. The robot is now equipped with an RGB camera for face detection and recognition and a depth camera for its navigation system.

First, as detailed in the initialization part in the figure 3, the ambient systems detects: a) An unidentified human is sleeping in the bedroom (*unknown.human1 isSleepingIn bed*), b) an identified human is cooking in the kitchen using the oven (*kitchen hasActivated oven, human1 isIn kitchen*), c) an identified human is watching tv in the living room (*livingRoom containsActivated tv, human1 isIn livingRoom*).

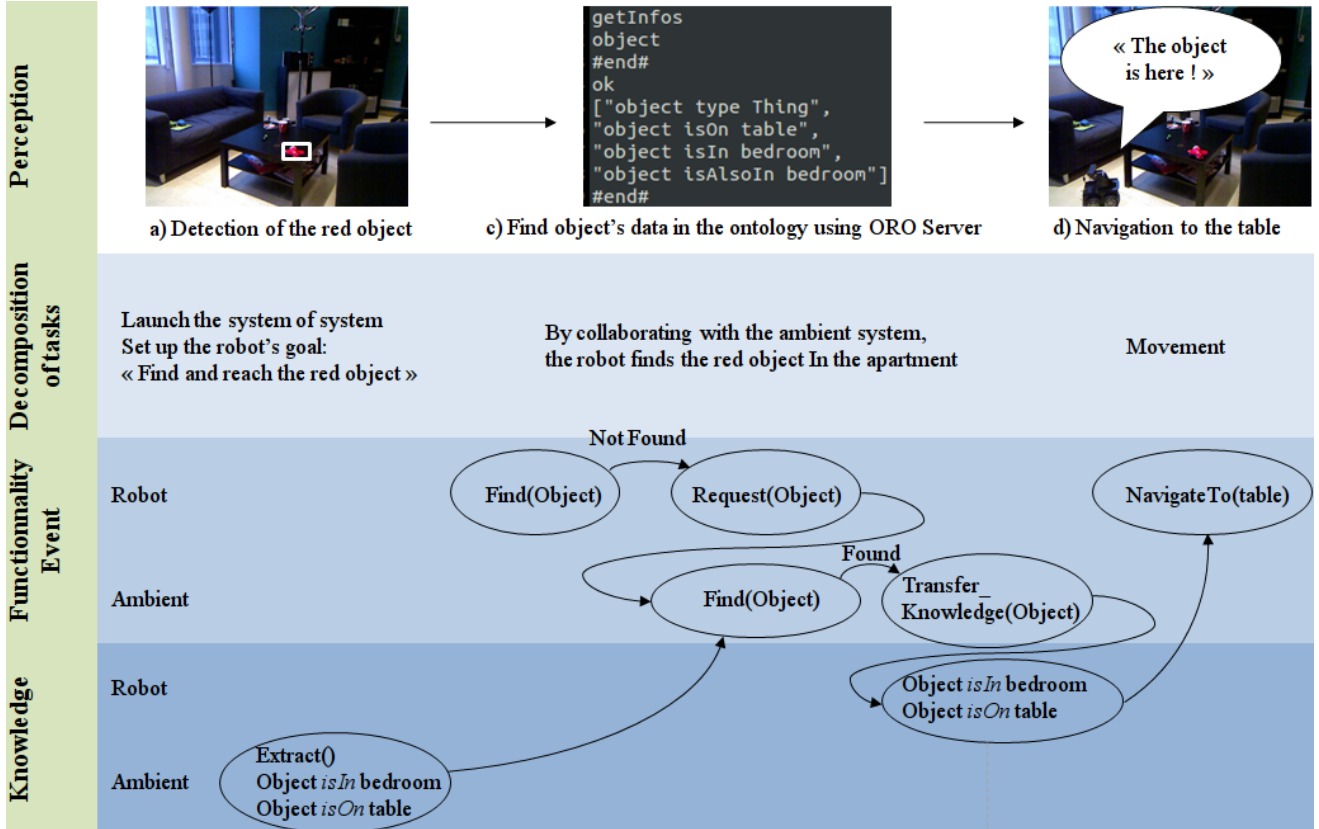

Fig. 2. Global overview of the system of systems knowledge transfer: Scenario where the robot work in with the ambient system to help a human to find a red-colored object in the apartment

Voluntarily, the two humans in the living room and in the kitchen are the same. So, when the system adds the last statement (*human1 isIn livingRoom*) in its ontology, as someone cannot be in two different places at the same moment (see the description of *isIn* in section III-B.2 for more information), an alarm is triggered due to the inconsistency and do not add this last statement in the ontology.

Finally the ambient system requests the robot to check every data [*?who isIn livingRoom*] and [*?who isIn kitchen*]. In other words, the ambient system requests the robot to share every information concerning who is in the kitchen and in the living room.

As the robot's ontology is initially empty, it navigates from its position to the living room and the kitchen (in order of request) to check the human identity. Then, using its loudspeaker, it asks to the person to look at him to be able to see the human's face and be able to recognize him. When the recognition process ends, the robot stores every extracted data in its ontology before sending them back to the ambient system. The same process is repeated again for the next request from the ambient system.

As the robot is in an "answering to request" mode, if an error occurs during this scenario and the robot's ontology is also inconsistent (e.g. one more time, if the same human is recognized in two different room), the robot will not request to the ambient to share data with him and will not send

the wrong statement but a *not found* answer instead without updating its ontology.

After the two identifications have been done, the ambient systems checks every human triplet. As the sleeping human is not identified it asks to the robot to get this last information. The robot is banned from the bedroom, thus it sends back to the ambient system an *not allowed room* answer to let the ambient system knows about the rule concerning the bedroom. The ambient system will not request again an identification for the bedroom and thus, avoiding any future request for information about the human which is sleeping.

V. CONCLUSIONS AND PERSPECTIVES

In this paper, we proposed an approach where a mobile robot and an ambient system platform collaborate to prevent wrong inferences from errors or inconsistencies from extracted data. The system of systems, designed to recognize activities of daily living, can use any kind of sensor to infer an activity as long as a software wrapper is implemented to ensure compatibility with the system. Features are extracted as high level data sent to an ontology for classification and reasoning. Activities are described in the ontology as new sets of object properties before activating the system.

While our system aims to recognize and analyze activities, only the approach used for clarification is described here. We scaled the validating tests corresponding to our needs (see

Initialization	
Ambient System	<p>Add information: <i>[unknown_Human0 isSleepingIn bed]</i> <i>[kitchen hasAnActivated oven, human1 isIn kitchen]:</i></p> <p>The Information <i>[human1 isCookingIn kitchen]</i> is inferred. <i>[livingRoom containsActivated tv, human1 isIn livingRoom]</i> leads to an inconsistency:</p>
Clarification	
Ambient system	request (<i>[?who isIn livingRoom]</i>)
Robot	<p>Receives the requests, navigate(<i>livingRoom</i>), when location is reached: speech(« <i>Can you look at me please ?</i> »)</p> <p>when the face is recognized add information: <i>[human1 isIn livingRoom]</i>, then sendback[<i>human1 isIn livingRoom</i>]</p>
Ambient System	<p>Received data from the robot: <i>[human1 isIn livingRoom]</i> Everything corresponding to <i>[?who isIn livingRoom]</i> is removed in the ontology and the returned data is added: add(<i>[human1 isIn livingRoom]</i>)</p> <p>request(<i>[?who isIn kitchen]</i>)</p>
Robot	<p>Receives the requests, navigate(<i>kitchen</i>), when location is reached: speech(« <i>Can you look at me please ?</i> »)</p> <p>when the face is recognized add information: <i>[human1 isIn kitchen]</i>, then sendback[<i>human1 isIn kitchen</i>]</p>
Ambient System	<p>Received data from the robot: <i>[human1 isIn kitchen]</i> Everything corresponding to <i>[?who isIn kitchen]</i> is removed in the ontology and the returned data is added: add(<i>[human1 isIn livingRoom]</i>)</p>

Fig. 3. Data based transcription of the interaction between the human, the robot and the ambient system, inconsistencies clarification

the two scenarios proposed in IV). However no evaluation like activity recognition analysis is done yet. Future works involve to use this platform to analyze ADL and IADL to assess the elderly's dependency. Several improvement are being investigated: Fuzzy ontologies approach to include more information about the data itself i.e. confidence coefficient, degree of truth, etc. Human Robot Interaction is also a possibility to clarify a situation. Being able to phrase a question at the end of the process when the global inference has a low confidence index.

ACKNOWLEDGMENTS

This work was funded within the framework of EBIOMED Chair part of IUIS (Institut Universitaire d'Ingénierie en Santé).

REFERENCES

- [1] A. QUEIRS, et al, Usability, accessibility and ambient-assisted living: a systematic literature review. Universal Access in the Information Society, 2015, vol. 14, no 1, p. 57-66.
- [2] J.J. KUFFNER, et al, Cloud-enabled robots, In: IEEE-RAS international conference on humanoid robotics, 2010, TN
- [3] K. KAMEI, Nishio, et al, Cloud networked robotics, IEEE Network, 2012. 26(3):2834.
- [4] N. Hu, Multi-user identification and efficient user approaching by fusing robot and ambient sensors, in Robotics and Automation (ICRA), 2014 IEEE International Conference on (pp. 5299-5306). IEEE.
- [5] M. JAMSHIDI, (ed.). Systems of systems engineering: principles and applications, CRC press, 2008.
- [6] R. ROS, Which one? grounding the referent based on efficient human-robot interaction, In : RO-MAN, 2010 IEEE. IEEE, 2010. p. 570-575.
- [7] R. STEVENS, Why use an ontology?, 2013 Ontogenesis.
- [8] E. Tapia, S. Munguia, et al. Activity recognition in the home using simple and ubiquitous sensors, In International Conference on Pervasive Computing, pp. 158-175. Springer Berlin Heidelberg, 2004.
- [9] H. STORF, T. Kleinberger, et al. An event-driven approach to activity recognition in ambient assisted living, In European Conference on Ambient Intelligence, pp. 123-132. Springer Berlin Heidelberg, 2009.
- [10] T. Van Kasteren, N. Athanasios, et al. Accurate activity recognition in a home setting, In Proceedings of the 10th international conference on Ubiquitous computing, pp. 1-9. ACM, 2008.
- [11] L. Xia, I. Gori, et al. Robot-centric activity recognition from first-person rgb-d videos, In Applications of Computer Vision (WACV), 2015 IEEE Winter Conference on. IEEE, 2015. p. 357-364.
- [12] L. Chen, J. Hoey, C. D. Nugent, et al. Sensor-based activity recognition, IEEE Transactions on Systems, Man, and Cybernetics, 2012 Part C (Applications and Reviews), 42(6), 790-808.
- [13] D. Riboni and C. Bettini, COSAR: hybrid reasoning for context-aware activity recognition, Personal and Ubiquitous Computing 15.3 (2011): 271-289.
- [14] M. WAIBEL, et al. Roboearth, IEEE Robotics & Automation Magazine, 2011, vol. 18, no 2, p. 69-82.
- [15] A. MANZI, et al. Design of a cloud robotic system to support senior citizens: The KuBo experience, Autonomous Robots, 2017, vol. 41, no 3, p. 699-709.
- [16] G. AMATO, et al. Robotic ubiquitous cognitive ecology for smart homes, Journal of Intelligent & Robotic Systems, 2015, vol. 80, p. 57.
- [17] S. Lemaignan, ORO, a knowledge management platform for cognitive architectures in robotics, in Intelligent Robots and Systems (IROS), 2010 IEEE/RSJ International Conference on. IEEE, 2010. p. 3548-3553.
- [18] E. SIRIN, Pellet: A practical owl-dl reasoner, in Web Semantics: science, services and agents on the World Wide Web, 2007, vol. 5, no 2, p. 51-53.