



HAL
open science

Power Modeling for Fast & Early Power Estimation of FPGA-based Communications Systems

Yehya Nasser, Jean-Christophe Prévotet, Maryline Héléard

► **To cite this version:**

Yehya Nasser, Jean-Christophe Prévotet, Maryline Héléard. Power Modeling for Fast & Early Power Estimation of FPGA-based Communications Systems. 12ème Colloque du GDR SoC/SiP, Jun 2017, Bordeaux, France. hal-01680485

HAL Id: hal-01680485

<https://hal.science/hal-01680485>

Submitted on 10 Jan 2018

HAL is a multi-disciplinary open access archive for the deposit and dissemination of scientific research documents, whether they are published or not. The documents may come from teaching and research institutions in France or abroad, or from public or private research centers.

L'archive ouverte pluridisciplinaire **HAL**, est destinée au dépôt et à la diffusion de documents scientifiques de niveau recherche, publiés ou non, émanant des établissements d'enseignement et de recherche français ou étrangers, des laboratoires publics ou privés.

1. Background

- Communicating devices are widespread
- IoT is everywhere
- Forecast: 50 billions devices available by 2020
- Huge impact on the world energy consumption
- FPGAs are parts of these communicating devices
- Energy estimation is a key point

1 Google search = ?
Same energy as 11-watt light bulb for an 1 hr.
Emit 7g CO2
There are 0.4B+ Google searches daily

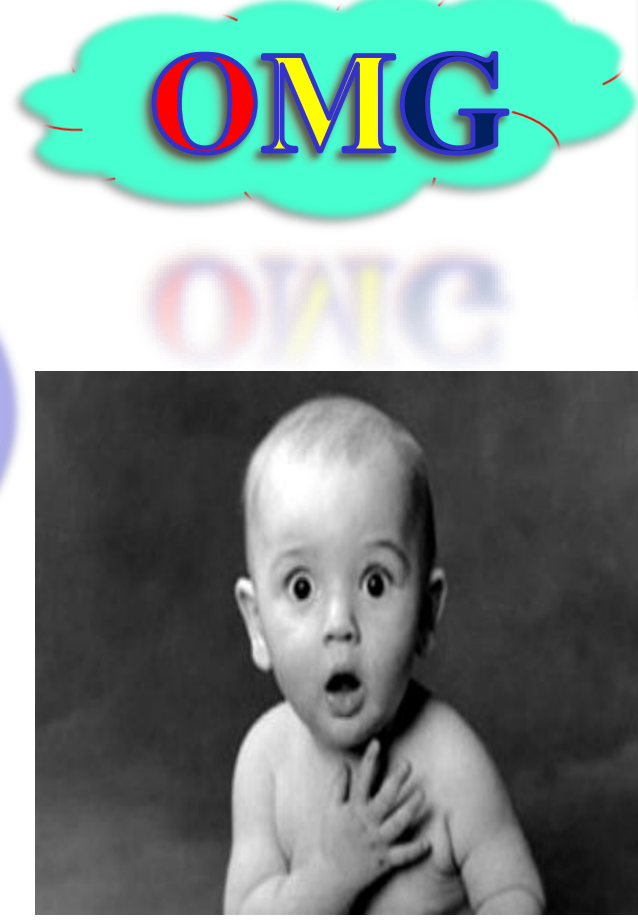

2. Motivation & Goals

Motivation:

- First step toward power reduction is power estimation
- FPGAs: Flexible, low cost & low time-to-market
- FPGAs: Consume 10x more power than ASICs.
- FPGAs: used as a final end product.

Goals:

- Design exploration for low power DSP algorithms
- High-Level power estimation strategy
- Accurate, early and fast power estimation

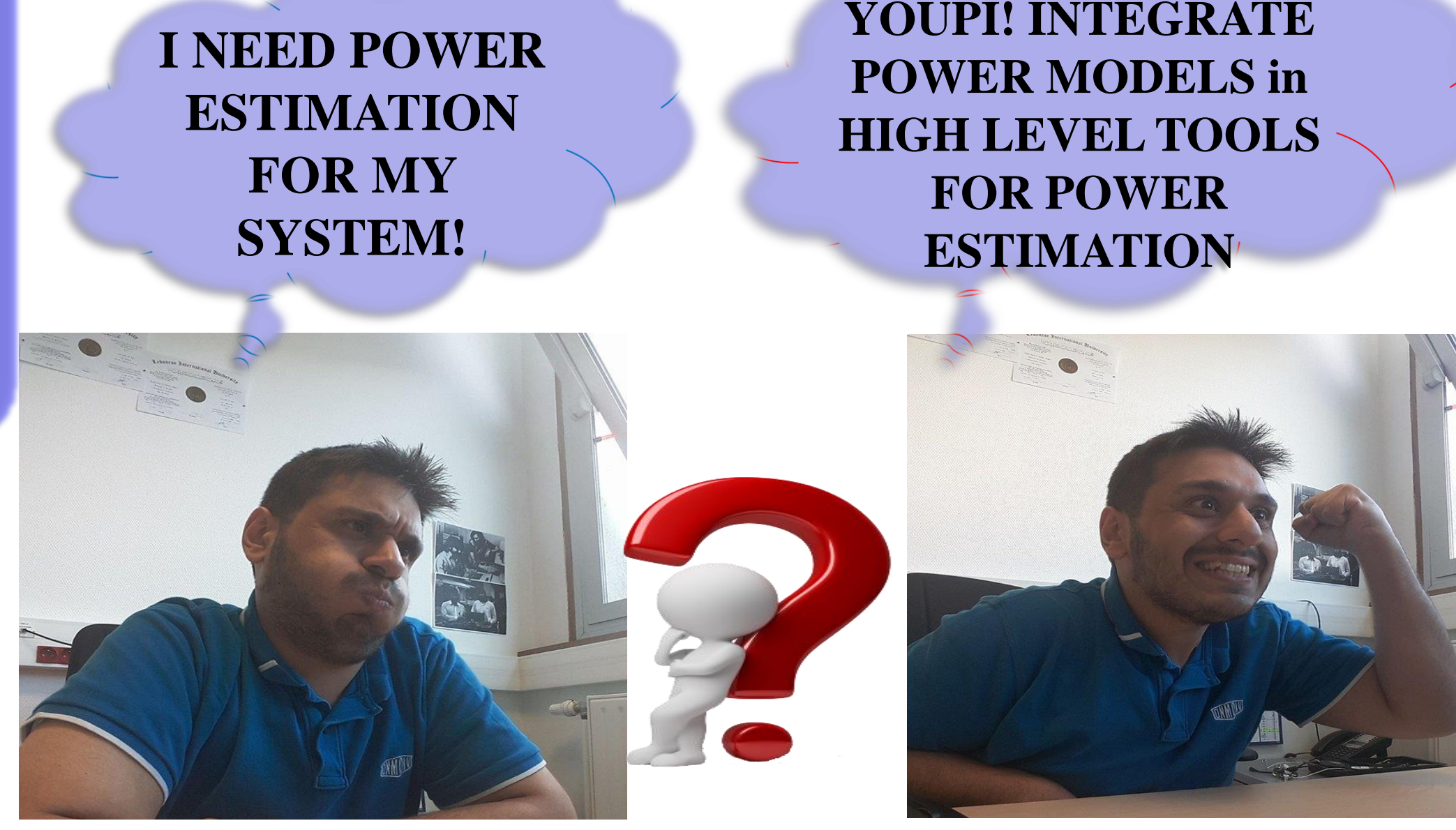
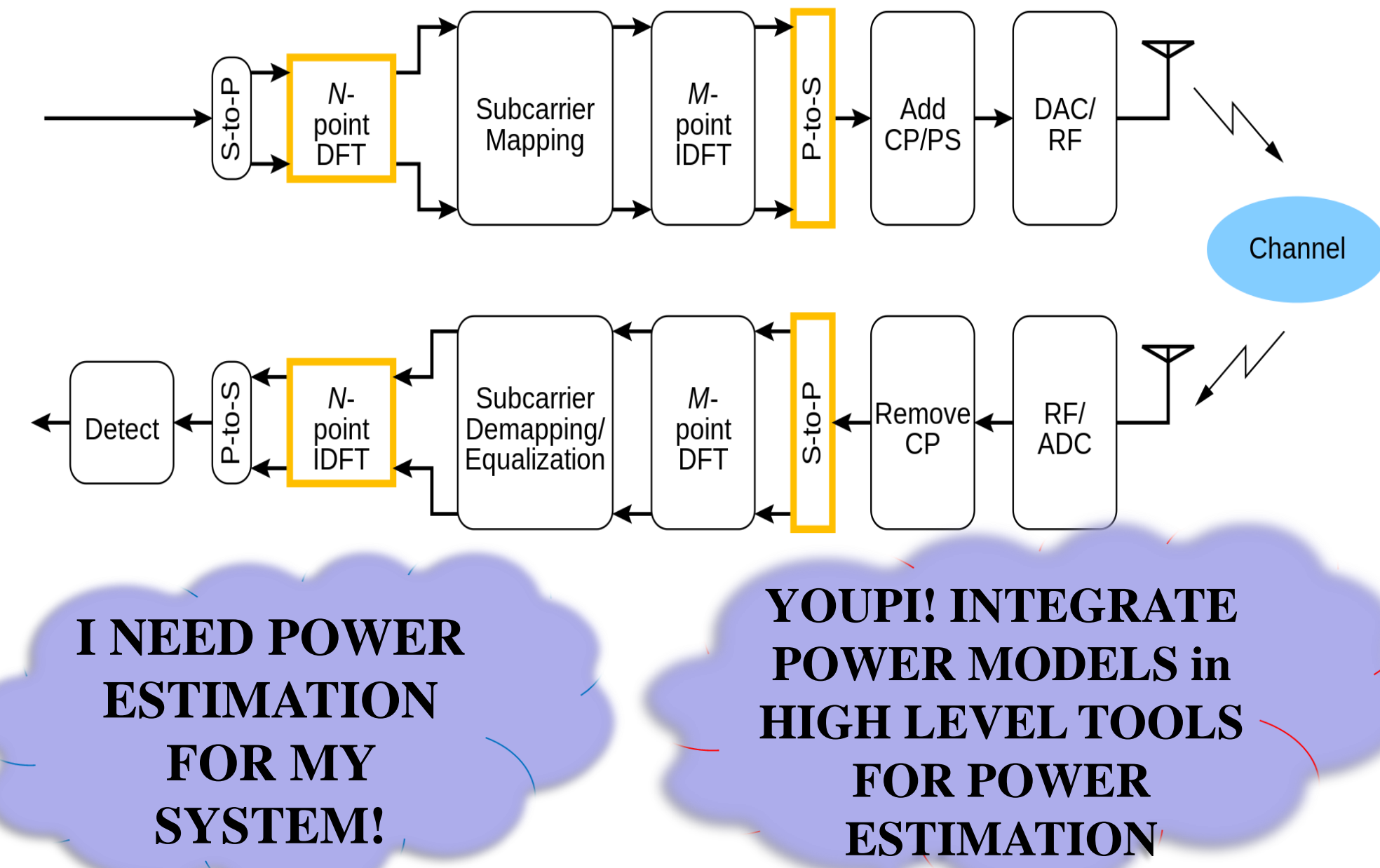
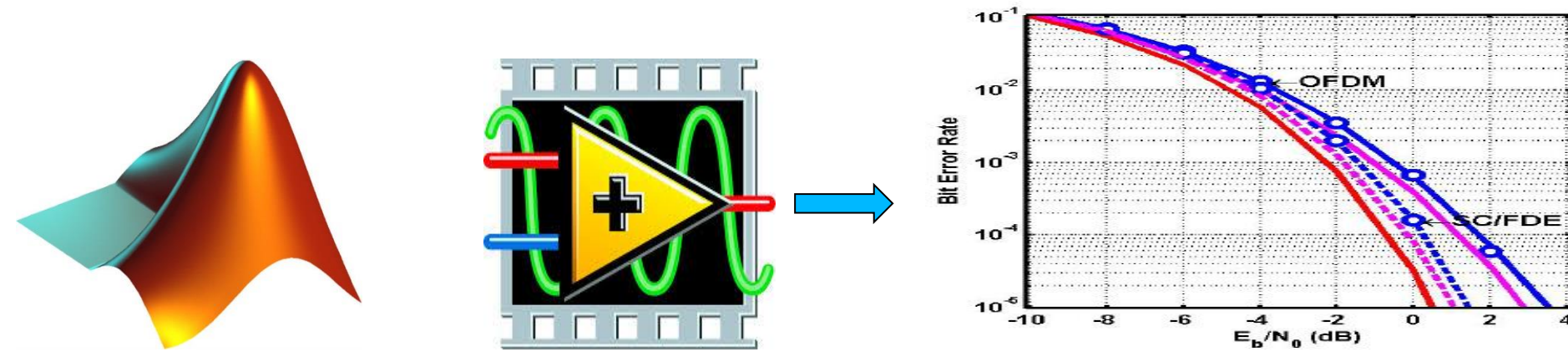

3.1 Theoretical Study

- $P_{Total} = P_{Dyn} + P_{Stat}$
- Static Power is technology dependent.
- Dynamic power is data dependent.
- $P_{Dyn} = SR \cdot C \cdot V^2$
- $SR = Signal Rate = \frac{Number\ of\ transitions(1 \rightarrow 0\ or\ 0 \rightarrow 1)}{T_{clock}}$
- SR is highly correlated to the input patterns.
- P_{Dyn} is highly correlated to the SR
- %high or static probability is the % of logic 1
- $P_{Dyn} = f(SR, \%high)$
- α : Input SR, P: Input static probability
- β : Output SR, h: Output static probability

3. Theoretical Study & Methodology

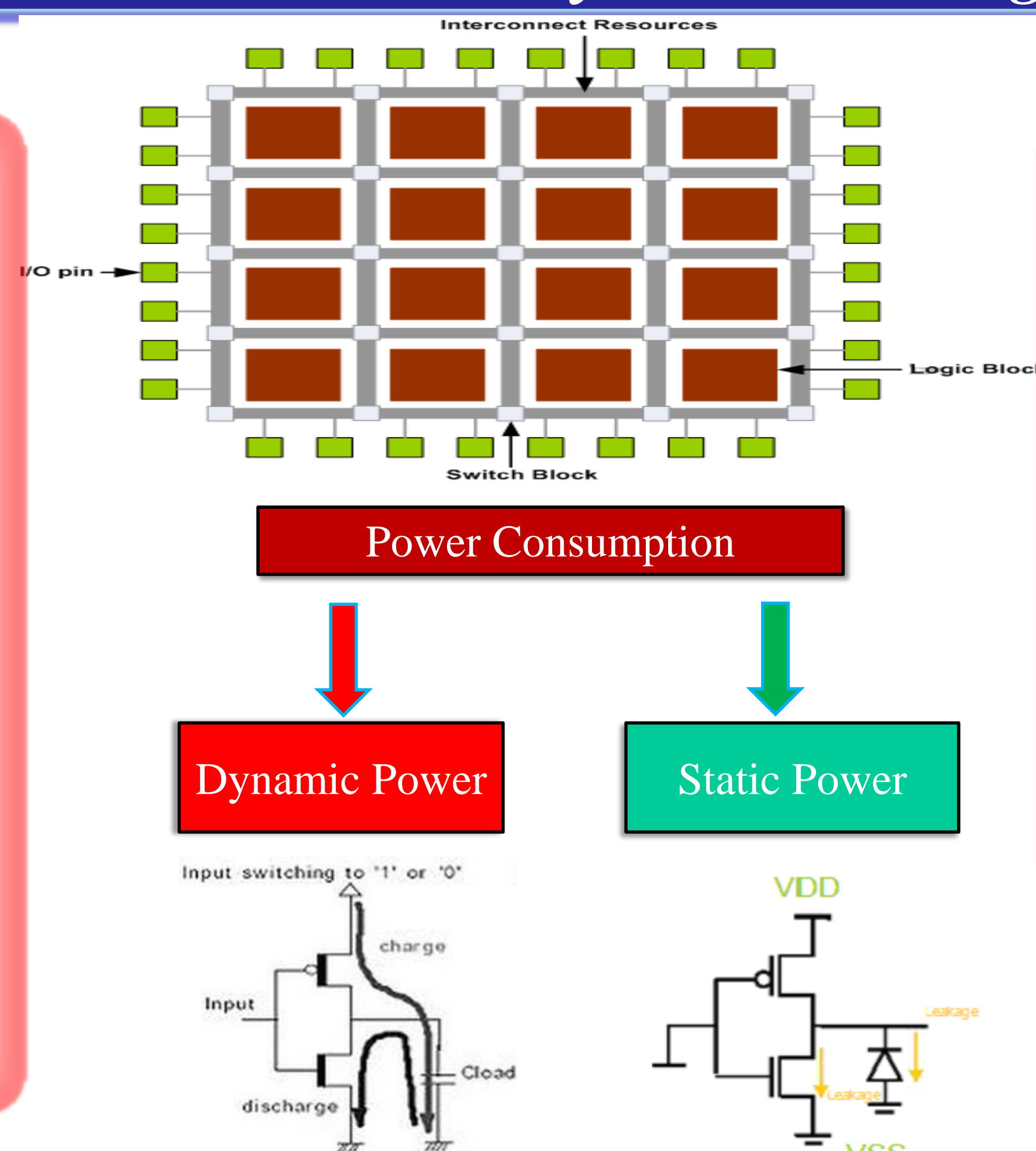

3.2 Methodology

- Digital system seen as a set of basic operators
- Each operator's power consumption is evaluated according to test_benches
- Use statistical information of the input patterns
- Provide low level power information to high level simulation tool
- Activity propagation throughout all operators for power estimation
- Evaluation of the global power consumption

Power Equation

$$P_{Global} = M_{1,1}(\alpha_1, p_1) + \sum_{i=2}^{N-1} M_{1,i}(\beta_{i-1}, h_{i-1})$$

Digital Operator Model

Power characterization

M1: Power Model

M2: SR & %high Model

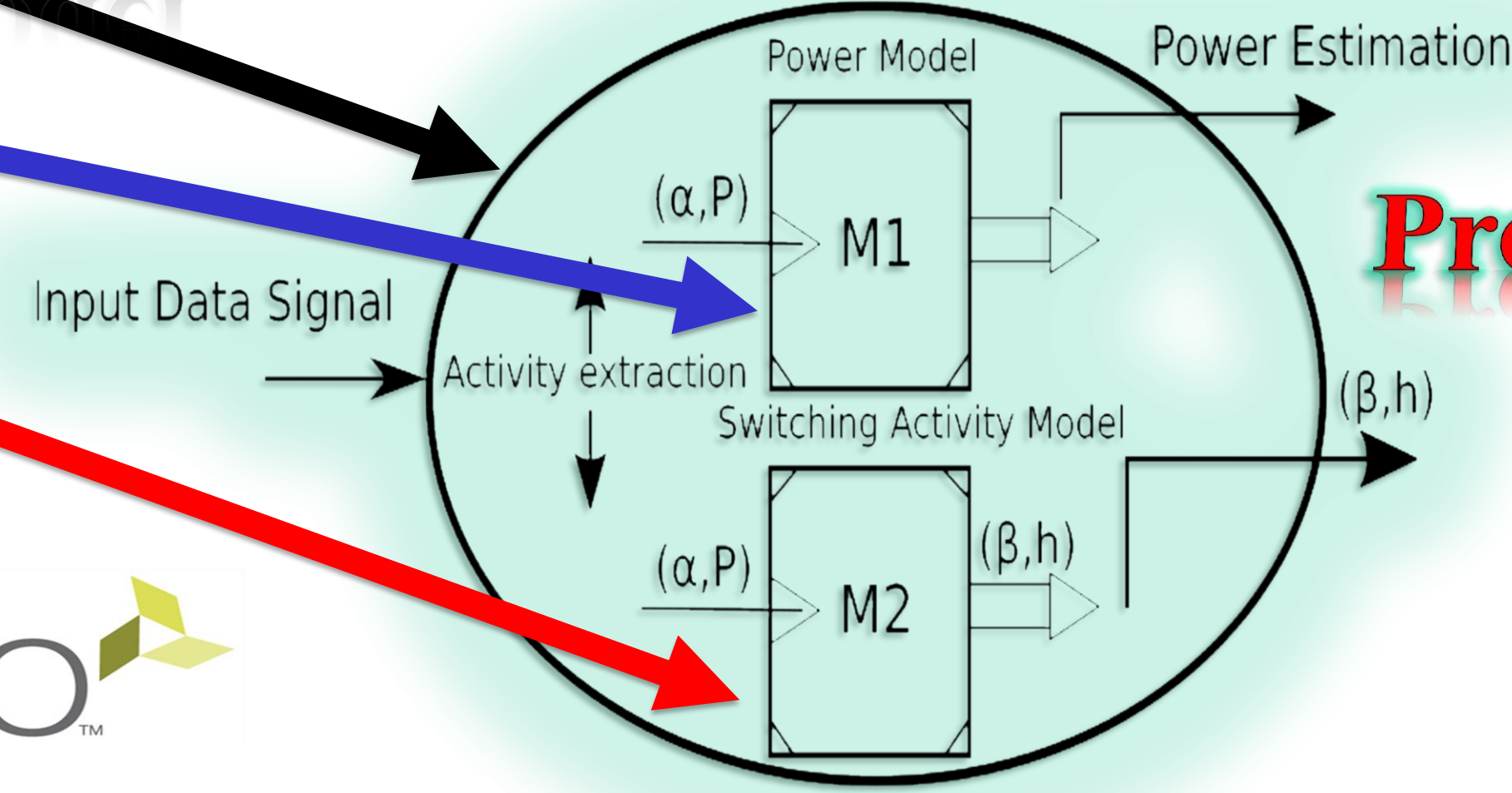

Propagation

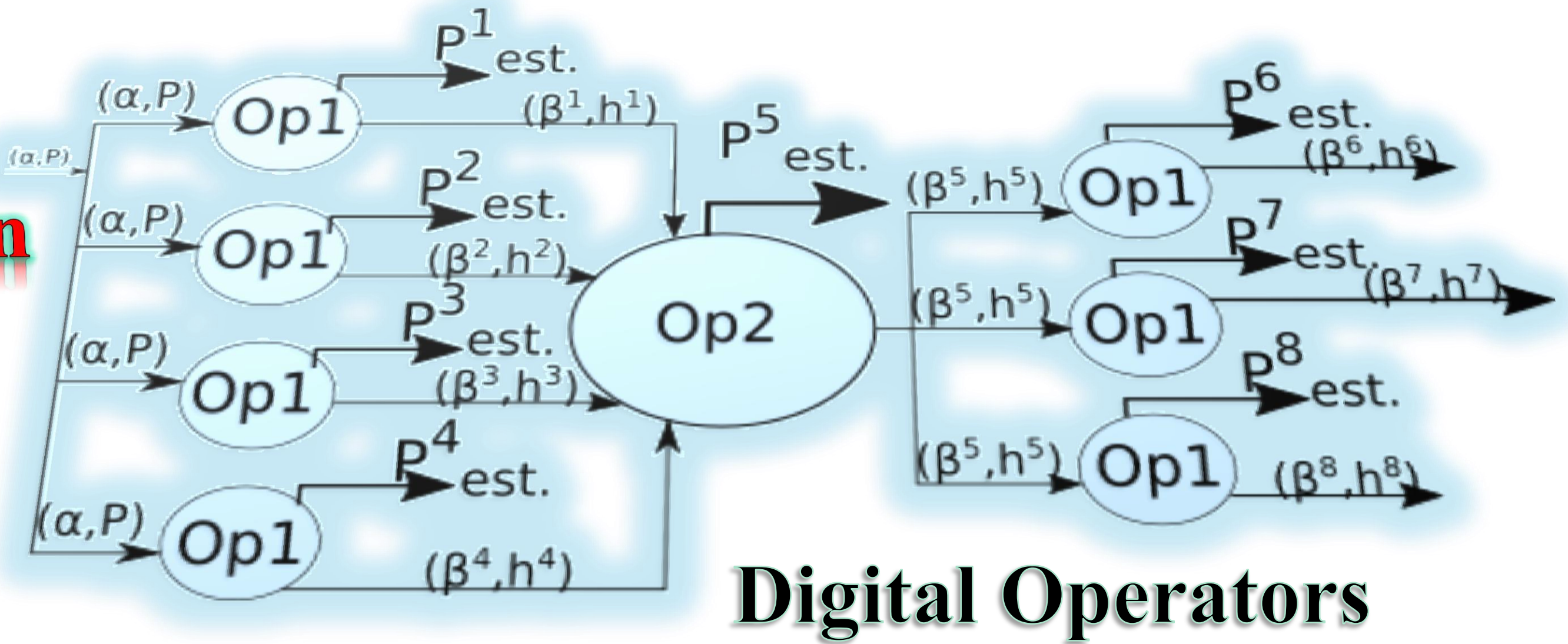

4. Case Study & Results

- Case study: Neural network implemented on FPGA
- Use of MAC (Multiply and accumulate) & Parallel to serial
 - MAC to achieve the multiplication & addition
 - P2S send the data serially to the next MACs
- NN Power Estimation (Vivado) : $P = 239mW$
- Our Methodology : $P = 221mW$
- Vivado based on default toggle rate : $P = 166mW$
- Error :
 - 8% (comparing to our Methodology)
 - 30,5% (comparing to default toggle rate)



5. Conclusion & Future Work

- Methodology for fast & accurate power :
 - Low level characterization of operators
 - Fast high-level simulation
- Exploration of communication system design
 - Speed up of the design process
 - Test of multiple scenarios for power assessment
- Library of predefined operators
- As Future work
 - Generalization to other FPGA families
 - Take real measurements into consideration



I AM READY TO WORK HARD FOR THE FUTURE