



**HAL**  
open science

# A Hierarchical Model for the Computation of Permeation Properties of Porous Materials and Their Enhancement due to Microcracks

Fadi Khaddour, David Grégoire, Gilles Pijaudier-Cabot

► **To cite this version:**

Fadi Khaddour, David Grégoire, Gilles Pijaudier-Cabot. A Hierarchical Model for the Computation of Permeation Properties of Porous Materials and Their Enhancement due to Microcracks. *Journal of Engineering Mechanics - ASCE*, 2018, 144 (2), pp.04017160. 10.1061/(ASCE)EM.1943-7889.0001392 . hal-01676761

**HAL Id: hal-01676761**

**<https://hal.science/hal-01676761>**

Submitted on 6 Oct 2022

**HAL** is a multi-disciplinary open access archive for the deposit and dissemination of scientific research documents, whether they are published or not. The documents may come from teaching and research institutions in France or abroad, or from public or private research centers.

L'archive ouverte pluridisciplinaire **HAL**, est destinée au dépôt et à la diffusion de documents scientifiques de niveau recherche, publiés ou non, émanant des établissements d'enseignement et de recherche français ou étrangers, des laboratoires publics ou privés.

# A hierarchical model for the computation of enhanced permeation properties of porous materials due to micro-cracks

by

Fadi Khaddour<sup>1</sup>, David Grégoire<sup>2</sup>, and Gilles Pijaudier-Cabot<sup>3</sup>, A.M. ASCE

**ABSTRACT:** This paper presents a model capable to provide estimates of the apparent permeability directly from the pore size distribution and from the properties of the fluid to be considered. The model is based on a hierarchical assembly of capillaries with decreasing diameter, generated randomly. The technique yields a porous network, which mimics the pore space measured experimentally by mercury intrusion. The intrinsic permeability and the evolution of the apparent permeability with mean pressure are provided by equating Darcy's law and a combination of Poiseuille's and Knudsen's laws. Comparisons with experimental data on mortar specimens show that the model provides the intrinsic permeability and its evolution when the material is subjected to mechanical loads. For a given pore size distribution, the evolution of the apparent permeability is also provided and test data with several types of gases compare quite well with the model.

---

<sup>1</sup> Laboratoire des Fluides Complexes et leurs Réservoirs, LFC-R UMR5150, Univ. Pau & Pays Adour, Allée du Parc Montaury, F64600 Anglet, France

<sup>2</sup> Laboratoire des Fluides Complexes et leurs Réservoirs, LFC-R UMR5150, Univ. Pau & Pays Adour, Allée du Parc Montaury, F64600 Anglet, France

<sup>3</sup> Laboratoire des Fluides Complexes et leurs Réservoirs, LFC-R UMR5150, Univ. Pau & Pays Adour, Allée du Parc Montaury, F64600 Anglet, France

## 20 INTRODUCTION

21 The relationship between the microstructure of cement, mortar and rocks and their permeation  
22 properties is a problem that has been addressed in many instances. Hydrocarbon production is a first  
23 example in which permeation properties have direct practical consequences. In most cases, the data  
24 available result from the extraction of cores during the exploration phase, and the permeability of  
25 the rock is related to its porosity. In the case of cementitious materials, what is at stake is not only  
26 the initial permeation properties of the material but also their evolution upon increasing, sustained  
27 or thermal loads. Because of micro-cracking, the permeability of the material increases (see e.g.  
28 Choinska et al. 2007). This increase is of great importance in the long-term assessment of tightness  
29 of vessels and waste containment facilities (see e.g. Jason et al. 2007).

30 In the literature, one may distinguish typically **several** approaches for estimating the permeability of  
31 a porous material.

32 In the first one, permeation properties are computed from pore network models. This approach  
33 allows a rather fine modelling at the pore scale in networks that are either generated randomly, e.g.  
34 on the basis of a pore size distribution using a discrete element approach (Li et al., 2016) or a lattice  
35 based model (Grassl, 2009), or taken from scanning electron microscope (SEM) images of mortar  
36 (see e.g. Wong et al. 2012, Sun et al. 2011, 2013). **Finite element or discrete element calculations**  
37 **can be coupled with Lattice-Boltzman calculations that solve the Stoke's problem in the pore**  
38 **network at the subscale or extracted from digital image analysis. It allows very accurate**  
39 **descriptions of the flow in the pore network coupled with the applied loads (White et al. 2006).**

40 Because the analysis is performed at the pore scale, multiphase flow and wettability considerations  
41 can be included in such models, allowing for estimates of relative permeability (see e.g. the review  
42 papers by Blunt, 2001 and Blunt et al., 2002). On the other hand, these very powerful techniques are  
43 quite computationally demanding, aside from the fact that each new state of micro-cracking in the  
44 material requires the consideration of a new pore network model.

45 The second type of approach relies on continuum based up-scaling and homogenisation theories.  
46 Berndt and Sevostianov (2012) discuss several micromechanical models in which the effective  
47 permeability of a heterogeneous material is derived from Darcy's law at the lower scale (Darcy,  
48 1856). It results into formulas where the porosity appears in the evaluation of the effective  
49 permeability of the porous material explicitly (see also Dormieux et al. 2006). Because these  
50 approaches do not represent the exact distribution of pores in the material (it is rather idealised  
51 through some concentration factors), they fail at capturing the effect of increasing micro-crack  
52 density on permeability as connectivity and tortuosity issues may arise. Extended models have been  
53 proposed for this purpose, e.g. by Chunsheng et al. (2011), based on specific micro-crack  
54 configuration (parallel cracks) and Monte-Carlo simulations. A more recent approach has been  
55 proposed by Timothy and Meschke (2016), in which the permeability is derived from cascade  
56 micromechanics, but the choice of the cascade number that controls connectivity properties is a  
57 pending issue.

58 The third type of approach is widely used in engineering applications and relies on analytical  
59 formulas where the input is the characterisation of the pore size distribution. Pioneering works by  
60 (Kozeny, 1927) related the permeability to the porosity, the tortuosity and an average pore size.  
61 Later on, Katz and Thompson (1986) predicted the permeability from the electrical conductivity of  
62 a porous material through a critical pores radius. Brown et al. (1991) provided a review of such  
63 approaches that may for instance be based on probabilistic descriptions of the interconnection  
64 between pores (Childs and Collis-George (1950), on percolation theory, or on combinations of both  
65 (Guegen and Dienes, 1989)). More recently, several studies appeared in which the pore size  
66 distribution has been modeled, e.g. with a bimodal (Aït-Mokhtar et al. 2002) or multimodal  
67 distribution (Amiri et al. 2005), and then entered into some capillary bundle model. A model for the  
68 calculation of the intrinsic permeability derived directly from the experimental pore size distribution  
69 (PSD), without any idealization has been also proposed (Khaddour et al. 2015).

70 In this paper, which is an extended and upgraded version of the conference paper by Khaddour et al.  
71 (2014), we are going to follow this type of approach, mainly because our final intend is to  
72 implement such a description into very large scale computations where at each point, the  
73 permeation properties are expected to change with micro-cracking due to applied loads. Hence, our  
74 aim is to devise a fast estimation technique that will be repeated a large number of times during a  
75 single calculation. In the present contribution, we will not reach this stage and we will stay at the  
76 level of the estimation of the permeation properties as a first step towards this final objective. The  
77 essential element from which the permeation properties are going to be estimated is the PSD. The  
78 present approach should be seen as follow up of models aimed at describing the influence of  
79 damage on the pore size distribution of mortar or rocks (Arson and Pereira, 2013) in order to  
80 provide a consistent hydro-mechanical framework to the context described above. **The experimental**  
81 **data provided may also serve validating these relationships, although providing or validating such is**  
82 **outside the scope of this paper.**

83 Mercury intrusion porosimetry (MIP) is going to be used for the determination of the PSD for  
84 various states of micro-cracking. It is well known that MIP has strong biases, e.g. for the  
85 characterisation of small pores (see Diamond, 2000). Furthermore, it cannot reach occluded  
86 porosity, but in our case such a porosity does not participate to permeation. MIP should be seen  
87 here as an indicator of connectivity and permeation capacity of the pore system, and not as an  
88 accurate characterisation technique for the determination of the complete pore network of the  
89 material.

90 The model presented in this paper is an extension of earlier works (Khaddour et al., 2015) and relies  
91 on a hierarchical capillary bundle description of the pore network, which mimics the porous space  
92 measured experimentally with MIP. In the literature, analyses are usually restricted to the intrinsic  
93 permeability of the material and the evolution of the apparent permeability with respect to the  
94 pressure gradient and to the nature of the fluid considered are left aside (see e.g. the review paper by  
95 Hoseini et al. (2009) on the effect of stress on permeability). **By apparent permeability, we mean the**

96 value of the permeability defined in the Darcy's sense, although it is not a material property. Here,  
97 we aim at a model capable to provide estimates of the apparent permeability as a function of the  
98 (compressible) fluid mean pressure, directly from the pore size distribution and from the properties  
99 of the fluid to be considered. The intrinsic permeability and the evolution of the apparent  
100 permeability with mean pressure are provided by combining Darcy's law which represents the flow  
101 in the porous media at the macro-scale and a combination of Poiseuille's (Poiseuille, 1840) and  
102 Knudsen's laws (Steckelmacher, 1986, Ziarani and Aguilera, 2012), which capture viscous flow and  
103 pore walls – fluid interaction at the micro-scale respectively. Knudsen's effect was found to be non  
104 negligible for pores of relatively large diameters (Kast and Hohenthanner, 2000) especially for tight  
105 rocks (Rahmanian et al., 2013) and mortar. It has been shown also that for typical gases, the  
106 contributions of laminar flow and of Knudsen diffusion are of the same order for pores of diameter  
107 in the range of a few hundred of nanometers (Khaddour et al., 2015).

108 This paper is organized as follows: in the second section, the construction of a random assembly of  
109 capillaries from a given pore size distribution is described. Then, the basic equations and solution  
110 techniques for computing fluid flow in such capillaries are discussed. The fourth section presents  
111 experimental works in which intrinsic and apparent nitrogen permeability evolutions upon damage  
112 have been obtained on mortar specimens. At each stage of damage, the PSD of the specimen is  
113 characterised. Comparisons between these experimental results and those obtained from the  
114 hierarchical model are discussed in the last section. Additional comparisons on the prediction of  
115 permeation properties for different gases are also provided.

## 116 **HIERARCHICAL CAPILLARY BUNDLE**

117 We consider here the porous structure of mortar in a very simplified way: it consists in straight  
118 cylindrical pores of different lengths and various diameters. Assuming that the porous space has  
119 been characterized by its pore size distribution, we may relate, for each pore size, the pore length to  
120 the pore volume fraction.

121 The simple assembly consists in distributing all the pores within the material in parallel and in a  
122 regular manner. The pore volume is divided into a set of capillary fibers of constant diameter and of  
123 length equal to the cubic root of the total porous volume for each diameter, times the tortuosity.  
124 Such an assembly is presented in Fig. 1 and permeability predictions based on such a parallel  
125 assembly of pores have been discussed by (Khaddour et al., 2015) and additional fitting parameters  
126 were required in order to achieve adequate results.

127 We adopt here a different approach where pores of different diameters are randomly connected to  
128 each other, under the condition that in the direction of the fluid flow, a given pore may only be  
129 connected to a smaller one. This hierarchical assumption is consistent with the technique  
130 implemented for obtaining the PSD, based on mercury intrusion porosimetry. The aim is to devise a  
131 model where the fitting parameters introduced in the simple assembly discussed by Khaddour et al.  
132 (2015) are avoided. Note that the model is based upon a fully connected pore space. Hence, the  
133 prediction of a percolation threshold that may be observed upon growing porosity is not possible.

134 In the present approach and in Khaddour et al. (2015) as well, the isotropy of the pore structure is  
135 assumed, providing as an outcome the same permeability in all directions (or an average  
136 permeability). This is a limitation embedded in the mercury intrusion technique used for obtaining  
137 the PSD. Therefore, the proposed model is mainly applicable to cases where anisotropy of the pore  
138 network (and of the permeability) is small. In the case of cementitious materials, the model applies  
139 on samples that have not been loaded, or on samples that have been loaded, with small micro-  
140 cracking, prior to the peak load in uniaxial compression typically. The comparisons that will be  
141 presented in the final section of this paper shall comply with such a restriction. It should be noted  
142 that serviceability analyses of nuclear reactor vessels for instance (see Jason et al. 2007) are  
143 conducted under the same assumption as it is considered that through-cracks are not expected. In  
144 the case of sedimentary rocks where transverse isotropy of the microstructure and of permeability  
145 should be expected, It might be envisioned to assign weighting factors corresponding to the  
146 directionality of the microstructure but such a possibility has not been considered in the present

147 paper and it is left for future considerations. For cases where extensive damage due to micro-  
148 cracking or localised cracking are observed, directionality effects on the permeability may be  
149 handled more easily by accounting on the crack aperture directly, e.g. through standard Poiseuille  
150 models (see Miehe and Mauthe, 2016, Pijaudier-Cabot et al. 2009, Chen et al. 2014).

151 The PSD is discretised into a finite set of pore diameters,  $i = 1, 2, \dots, N$ . Let  $V_i$  be the total porous  
152 volume, which may be organized according to the PSD into a series of volumes  $V_{pi}$  of mean  
153 diameter  $d_i$ . We may now relate, for each pore size, the total pore length  $L_i$  to the pore diameter  $d_i$   
154 and to the pore volume fraction  $V_{pi}$  assuming that pores are cylindrical:

155

$$156 \quad L_i = \frac{4.V_{pi}}{\pi.d_i^2} \quad (1)$$

157

158 This total pore length is then cut into small segments of random length  $\Delta L_i$  (see Figure 2.a)  
159 **comprised between 0 and the average pore length defined below**. Their assembly is performed from  
160 larger pores to smaller pores. Each pore segment either creates a new assembling site, on which  
161 subsequent segment will be connected to form a single capillary, or is connected to an existing one  
162 of larger or equal diameter on an existing assembling site (Figure 2.b). We then define the average  
163 pore length  $L_e$  and a critical length  $L_c$  as

164

$$165 \quad L_e = \sqrt[3]{V_t}, L_c = T.L_e \quad T = \text{tortuosity} \quad (2)$$

166

167 Throughout this study, the tortuosity will be taken equal to 1. **In our description, large pores are the**  
168 **most important factor on permeability and therefore, the influence of the tortuosity is diminished.**  
169 **This assumption is also made fore the sake of simplicity. Assigning a specific tortuosity on each**  
170 **class of pore diameters would be possible, at the price of additional model parameters that would be**  
171 **very delicate to characterise. Finally, one should keep in mind that orders of magnitude are often**  
172 **sought for in predictions of permeability in view of its experimental and spatial variability. Thus**



173 setting the tortuosity to 1 still provides a suitable estimate that ought to be considered as a local  
174 quantity resulting from an averaged PSD.

175 As soon as the sum of all pore segment lengths reaches the critical length on one capillary fiber,  
176 further segments cannot be added anymore.

177 The random function, which decides if the current pore segment dealt with is connected to an  
178 existing capillary (or assembling site) or creates a new one, is:

179

$$180 \quad f(x) = \exp\left(-\frac{(x-B)}{A}\right) \text{ if } x > B, \text{ and } f(x) = 1 \text{ if } x \leq B \quad (3)$$

181

182  $f(x)$  is the probability that a new segment may create a new assembling site and subsequently a  
183 new capillary fiber.  $x$  is the index of the current pore segment dealt with **i.e. the number of the pore**  
184 **segment comprised between 0 and the total number segments to be dealt with considering all the**  
185 **pore diameters**,  $A$  is a parameter controlling the starting diameter when the new pore segments have  
186 almost no chance to create a new site (capillary) and  $B$  is a parameter controlling the starting  
187 diameter when the new pore segments have a chance to be connected to existing sites. If the index  $x$   
188 is lower than  $B$ , the current pore increment is forced to create a new site ( $f(x) = 1$ ).

189 When the hierarchical capillary bundle is generated, the fact that a pore segment is connected to an  
190 existing capillary (or assembling site) or creates a new one is critical in achieving a good estimate  
191 of the permeability. This reflects on the technique that is implemented in order to obtain the PSD  
192 and on the evolution of the PSD upon micro-cracking.

193 During mercury intrusion porosimetry, two different phases of intrusion are performed. Firstly,  
194 mercury is introduced at low pressure (from 0 MPa to 0.2 MPa). Then, mercury is introduced at  
195 high pressure (from 0.2 MPa to 200 MPa). The smaller the pores, the higher the pressure needed to  
196 introduce mercury inside the porous medium. Unfortunately, the data obtained at low pressure are  
197 very noisy and very large pores are not well characterised. These large pores drive the permeability  
198 and it can be very problematic in order to predict the permeability accurately. Usually, the solution

199 consists in removing the low-pressure information in the analysis. Figure 3.a presents a typical PSD  
200 obtained on the mortar used in the present study. We can see the result from the low pressure  
201 intrusion (above  $5 \mu m$ ) and the one from the high pressure intrusion (below  $5 \mu m$ ) and two peaks  
202 are observed. Upon damage, e.g. due to mechanical loads, newly created pores (open cracks) of  
203 large aperture might contribute significantly to the permeability. Therefore, there is a need to keep  
204 the low-pressure information to predict the evolution of permeability upon damage and we have  
205 implemented a specific filtering of the low-pressure information in connection with the function  
206 defined in Eq. (3). Newly created cracks are most certainly not cylindrical but they are assumed as  
207 such in our approach and in the interpretation of MIP results too. In both cases, we deal with flow  
208 into newly formed pores, whatever their shape and it is important that assumptions be the same in  
209 each case. In this way, there is no bias between the characterisation of the PSD and the permeability  
210 analysis, although the models are a rough approximation of actual pore shapes.

211 In order to keep the low pressure information, and therefore to account for large pores, we  
212 implement a procedure aimed at minimizing their impact on the overall permeability by making  
213 sure that capillaries of large diameter have little chance to percolate. In such a way the inaccuracies  
214 encountered during the low pressure intrusion have little effect on the overall estimation of  
215 permeability: let us consider the pores of size corresponding to the low-pressure measurements  
216 only. These pores are discretized randomly into segments of equal size. We now count the number  
217 of segment corresponding to these pore sizes. Figure 3b shows this number for several random  
218 realizations. We observe that the first 10000 segments correspond to the average number of pores  
219 segments whose diameter is large enough to be intruded during MIP at low pressure and therefore  
220 we force them to create a new assembly site instead of being connected to each other. Consequently  
221 pores of such sizes cannot percolate throughout the material and they cannot provide a dramatic  
222 overestimation of the overall permeability. Their contributions to the PSD, however, still exists in  
223 the hierarchical assembly, these 10000 segments are located at the entry of capillaries, the rest that  
224 occurs in the random generation may or may not be connected to them according to the probability

225 function in Eq. (3). The limit of 10000 segments depends on the specific material considered.  
226 Hence, it is set for a given material and its PSD. For the same material, and upon micro-cracking,  
227 this limit is not changed, allowing for capturing the influence of subsequent micro-cracks on the  
228 capillary generation and on the calculation of the permeability.

229 Accordingly, the parameter  $B$  in Eq.(3) is chosen in such a way that the first 10000 low-pressure  
230 pore segments are forced to create a new site ( $f(x) = 1$ ). Upon damage, if meaningful information  
231 appear in the low-pressure part of the PSD, the number of increments at low-pressure will increase  
232 and then they will be taken into account automatically when  $x > B$ .

233 In the generation process, the permeability is calculated each time a capillary has reached the  
234 critical length. The contribution of this capillary to the permeability is added to the contributions of  
235 previous ones. When this contribution is less than a given percentage of the total permeability, the  
236 random process is stopped. The number of segment already assembled is  $N_{ass}$  and the rest of the  
237 pore segments are assembled into capillaries of constant diameter in order to save computer time  
238 (small pore sizes lead to a huge amount of pore segments to assemble). Their contribution is also  
239 taken into account in the global permeability.

240 The parameter  $A$  in Eq. (3) controls the decay of function  $f(x)$ . In particular,  $A$  controls the  
241 segment number above which new segments have almost no chance (say a few percent) to create a  
242 new capillary and should be connected to existing ones. Its influence on the calculation of the  
243 permeability is small if this segment number is above  $N_{ass}$  because new segments will be connected  
244 to each other anyway to form capillaries of constant diameter. The parameter  $A$  has been chosen  
245 equal to 1000 to ensure that this condition is met.

## 246 **CALCULATION OF THE PERMEABILITY**

247 The objective is now to compute the intrinsic and the apparent permeability from a given assembly  
248 of capillary fibers. The apparent permeability is obtained by equating Darcy's law, which represents  
249 the flow at the macro-scale, and Poiseuille's and Knudsen's laws, which represent the flow at the

250 micro-scale. This approach has already been detailed by (Khaddour et al., 2015) for a deterministic  
 251 assembly of parallel pores of constant diameter. The model assumes that permeation properties are  
 252 isotropic, which means that capillary bundles are randomly oriented in the porous material. As  
 253 discussed in the previous section, the assumption of isotropy is a restriction of the present model.  
 254 The fluid fluxes computed in this section shall be divided by three in order to compute the  
 255 directional permeability and to account for isotropy, which means that the fluid flow equally in the  
 256 three directions of space. Under the same assumption, we are going to extend this calculation to the  
 257 case of capillaries composed of segments of decreasing diameters.

258

259 *Flow in a pore of constant diameter*

260 Let us consider a cylindrical pore of diameter  $d_i$ . The fluid flux (i.e. volume of fluid per unit time)  
 261 passing through the pore of length  $L_e$  is calculated according to Poiseuille's law:

262

$$263 \quad Q_P^v = \left(\frac{1}{2}\right) \frac{\pi}{128} \frac{d_i^4}{\mu} \frac{(P_1^2 - P_2^2)}{L_e P_2} \quad (4)$$

264

265 where  $(P_1, P_2)$  are the upstream and downstream pressure respectively,  $Q_P^v$  is the volume of fluid  
 266 estimated at the outlet pressure and  $\mu$  is the fluid dynamic viscosity. This classical expression relies  
 267 on the assumption of laminar flow.

268 At the same time, the flow of a gas in the pore may be influenced by the pore walls. An indicator  
 269 for such an interaction is the Knudsen number  $N_i^{Kn}$  defined for each pore of diameter  $d_i$  by:

270

$$271 \quad N_i^{Kn} = \frac{\lambda}{d_i} = \left(\frac{1}{d_i}\right) \frac{R T}{\pi \sqrt{2} d_j^2 N_{Av} P_m} \quad (5)$$

272

273 where  $(\lambda, d_j, P_m)$  are the average free path, the molecule diameter and the average pressure of the  
 274 considered gas respectively, and  $(N_{Av})$  is the Avogadro's number. When the Knudsen number is

275 greater than one, the interaction between the walls of the pore and the gas, at the molecular level,  
 276 are dominant and the fluid flow is quite different from Poiseuille's flow. The volume of fluid per  
 277 unit time passing in the pore is (Steckelmacher, 1986):

$$279 \quad Q_{Kn}^v = \frac{\pi d_i^3}{12 L_e} \sqrt{\left(\frac{8RT}{\pi M}\right) \frac{\Delta P}{P_2}} \quad (6)$$

280  
 281 where  $\Delta P = P_1 - P_2$  is the difference between the upstream and downstream pressures. In the  
 282 transition regime defined as ( $0.01 < N_i^{Kn} < 1$ ) the flow rate  $Q_{tot}^i$  through a pore ( $i$ ) due to a pressure  
 283 gradient  $\Delta P$  is given as the sum of the viscous flow (Eq. 4) and the Knudsen's flow (Eq. 6):

$$285 \quad Q_{tot}^i = Q_{Kn}^i + Q_{Kn}^i, \quad Q_{tot}^i = \frac{\pi d_i^4}{L_e} \left[ \frac{1}{128 \mu} + \frac{1}{12 d_i} \sqrt{\left(\frac{8RT}{\pi M}\right)} \left(\frac{1}{P_m}\right) \right] \frac{\Delta P P_m}{P_2} \quad (7)$$

286  
 287 where  $P_m$  is the average pressure  $(P_1 + P_2)/2$ .

### 289 *Flow in a capillary with segments of decreasing diameter*

290 In order to be applied to the present hierarchical model, the flow rate for the case of a capillary  
 291 made of segments of pores with decreasing diameter needs to be calculated. A typical capillary of  
 292 this type is shown in Fig. 4. Mass conservation requires that:

$$294 \quad P_2 \delta Q_a = \frac{\pi d_1^4}{L_1} \left[ \frac{1}{128 \mu} + \frac{1}{12 d_1} \sqrt{\left(\frac{8RT}{\pi M}\right)} \left(\frac{1}{P_{m1}}\right) \right] \Delta P_1 P_{m1} = \dots =$$

$$295 \quad \frac{\pi d_j^4}{L_j} \left[ \frac{1}{128 \mu} + \frac{1}{12 d_j} \sqrt{\left(\frac{8RT}{\pi M}\right)} \left(\frac{1}{P_{mj}}\right) \right] \Delta P_j P_{mj} = \dots$$

$$296 \quad = \frac{\pi d_M^4}{L_M} \left[ \frac{1}{128 \mu} + \frac{1}{12 d_M} \sqrt{\left(\frac{8RT}{\pi M}\right)} \left(\frac{1}{P_{mM}}\right) \right] \Delta P_M P_{mM} \quad (8)$$

297

298 where  $\Delta P_j, P_{mj}$  are the difference between the upstream and downstream pressures and the average  
 299 pressure in segment  $j$  respectively. Because the sum of the difference of square pressures is equal to  
 300 the overall difference of the square pressures for the entire capillary, we have also:

301

$$302 \quad \Delta P_1 P_{m1} + \dots + \Delta P_j P_{mj+1} + \dots + \Delta P_M P_{mM} = \Delta P P_m \quad (9)$$

303

304 Combining the two above equations, one obtains:

305

$$306 \quad \delta Q_a = \frac{1}{\sum_{j=1}^M \frac{1}{\pi d_j^4 \left[ \frac{1}{L_j} \left( \frac{1}{128 \mu} + \frac{1}{12 d_j} \sqrt{\frac{8RT}{\pi M}} \right) \left( \frac{1}{P_{mj}} \right) \right]}} \frac{\Delta P P_m}{P_2} \quad (10)$$

307

308 This expression gives the flow rate as a function of the upstream and downstream pressures applied  
 309 to the capillary, but also as a function of the mean pressures in each segment, which are unknown.

310 These unknown are solved iteratively. Given the mean pressure distribution at step  $(I - 1)$ , the flow  
 311 rate in each pore segment is computed according to Eq. (8). We obtain for each segment a flow rate

312  $\delta Q^{I-1}$ . Because the pressure distribution is not correct (and conservation of mass is not satisfied),

313 this flow rate does not satisfy Eq. (10). A new value of the difference at the inlet and outlet of each

314 segment can be computed according to this equation:

315

$$316 \quad \Delta P_j^I = \frac{\delta Q^{I-1} P_2}{P_m} \sum_{j=1}^M \frac{1}{\pi d_j^4 \left[ \frac{1}{L_j} \left( \frac{1}{128 \mu} + \frac{1}{12 d_j} \sqrt{\frac{8RT}{\pi M}} \right) \left( \frac{1}{P_{mj}^{I-1}} \right) \right]} \quad (11)$$

317

318 and the new distribution of pressure in each segment of the capillary at step  $I$  can be computed. The

319 calculation starts with a linear distribution of pressure over the capillary and stops when the error

320 defined as:

321

322 
$$\varepsilon^I = \left( \frac{\delta Q^I - \delta Q^{I-1}}{\delta Q^{I-1}} \right)^2 \quad (12)$$

323

324  $\varepsilon^I$  is less than a given threshold ( $10^{-24}$ ). Figure 5 shows the result of such a calculation in the case  
 325 of a capillary made of three segments of equal length subjected to a difference of pressure of 0.3  
 326 MPa. In this case, the iterative scheme converges very rapidly (12 iterations), the logarithm of the  
 327 error being a nearly linear function decreasing with the number of iterations. In the case of  
 328 Poiseuille flow, the pressure distribution should be linear. Because of Knudsen effect, the pressure  
 329 increases in the capillary.

330

331 *Permeability of the hierarchical capillary bundle*

332 For a given random assembly of capillary fibers, the transport properties are obtained by adding the  
 333  $N_s$  contributions of each capillary:

334

335 
$$Q_{tot} = \sum_{i=1}^{N_s} \delta Q_i = \frac{\Delta P P_m}{P_2} \sum_{i=1}^{N_s} \frac{1}{\sum_{j=1}^{m(i)} \frac{1}{\frac{\pi d_j^4}{L_j} \left[ \frac{1}{128 \mu} + \frac{1}{12 d_j} \sqrt{\left( \frac{8 R T}{\pi M} \right) \left( \frac{1}{P_{mj}} \right)} \right]}} \quad (13)$$

336

337 where  $m(i)$  is equal to 1 for capillaries of constant diameter and then  $L_j = L_e$ . At the macro-scale,  
 338 the flow rate through the porous medium is described by Darcy's law:

339

340 
$$Q_D^v = \frac{K_a}{\mu} S \frac{\Delta P P_m}{L_e P_2} \quad (14)$$

341

342 where  $S$  is the apparent cross section of the material through which gas flows. Comparison between  
 343 Eq (13) and Eq (14) provides the expression of the apparent permeability  $K_a$ :

344

345 
$$K_a = \left( \frac{\mu L_e}{S} \right) \sum_{i=1}^{N_s} \frac{1}{\sum_{j=1}^{m(i)} \frac{1}{\frac{\pi d_j^4}{L_j} \left[ \frac{1}{128 \mu} + \frac{1}{12 d_j} \sqrt{\left( \frac{8 R T}{\pi M} \right) \left( \frac{1}{P_{mj}} \right)} \right]}} \quad (15)$$

346

347 This expression may appear rather complex, but the dependence on the average pressure is quite  
 348 similar to that in Klinkenberg's expression (1941) of the permeability to gas in a porous material.  
 349 The apparent permeability depends on the inverse of the pressure distribution because Poiseuille's  
 350 flow is a function of the square of the pressure whereas Knudsen flow is linearly dependent on the  
 351 pressure. The intrinsic permeability  $K_{in}$  is obtained by considering an infinite average pressure:

352

353 
$$K_{in} = \left( \frac{\mu L_e}{S} \right) \sum_{i=1}^{N_s} \frac{1}{\sum_{j=1}^{m(i)} \frac{1}{\frac{\pi d_j^4}{L_j} \left[ \frac{1}{128 \mu} \right]}} \quad (16)$$

354

355 and it depends on the contribution of Poiseuille's flow only. **Recall that the permeability calculated**  
 356 **account for an isotropic flux. Hence, it needs to be divided by three in order to compare with the**  
 357 **directional permeability obtained next experimentally.** We are now are going to describe the  
 358 experiments carried out in order to evaluate the capabilities of the above model.

## 359 **EXPERIMENTS**

### 360 *Specimens and testing description*

361 Experiments have been performed on mortars specimens with a water/cement ratio of 0.7 and a  
 362 maximum aggregate diameter of 3mm. The composition is reported in Table 1. Mortar was cast in  
 363 aluminum moulds (dimensions: 40x60x400 in mm). Cylindrical holes were moulded by adding  
 364 metallic bars of diameter 6.5mm in the mould. Finally, a core drill was used to extract a cylindrical  
 365 hollow specimen (outer diameter=24.5mm; inner diameter=6.5mm; height=40 mm). Note that top  
 366 and bottom surfaces were rectified using an accurate cutting machine. Finally, the samples were  
 367 cured in a ventilated oven at 80°C at constant humidity during 48 hours.



368 The testing apparatus consists in a conventional electro-mechanical testing machine (Zwick Proline  
369 Z20, maximal force: 20kN) coupled with a nitrogen permeameter in order to measure in-situ the  
370 radial permeability under loading (Fig. 6). This set-up is similar to the one implemented by  
371 Choinska et al. (2007), but the specimens are much smaller so that they can fit in the mercury  
372 intrusion machine.

373 The tests are displacement controlled in order to avoid post-peak unstable regime. Figure 7 presents  
374 a typical measurement cycle. A small preload is first applied to seal the upper and lower faces of the  
375 specimen so that leakage occurs on the outer circular surface only. The initial permeability is then  
376 measured and a given compressive load is applied. Permeability under load and after unloading is  
377 measured. Several cycles are performed on different specimens made of the same material in order  
378 to describe different states of increasing damage in mortar.

379 After complete unloading, the middle part of each sample (15mm over 40mm) is cut and further  
380 used in order to characterize the PSD by mercury intrusion. The same sample cannot be  
381 characterized in term of PSD and then loaded again. Nevertheless, the reproducibility of the PSD  
382 measurements as well as of the mechanical response of different samples has been checked. Each  
383 PSD is obtained as an average of measurements on 3 different specimens.

384

### 385 *Experimental measurements*

386 Damage  $D$  is defined as the relative reduction of the modulus of elasticity upon unloading-  
387 reloading:

388

$$389 \quad \sigma = E \varepsilon = (1 - D)E_0 \varepsilon , \quad D = 1 - \left(\frac{E}{E_0}\right) \quad (17)$$

390

391 where  $(\sigma, \varepsilon, D, E, E_0)$  are respectively the uniaxial stress and strain, the damage parameter and the  
392 current and initial elastic moduli.

393 The apparent permeability is measured by applying a pressure gradient and measuring the gas flow  
394 through the sample (Scheidegger, 1974):

395

$$396 \quad K_a = \frac{Q_i \mu P_i \ln\left(\frac{R_2}{R_1}\right)}{\pi h (P_i^2 - P_2^2)} \quad (18)$$

397

398 Here, nitrogen is used.  $Q_i$  is the gas volumetric flow,  $(h, R_2, R_1)$  are the sample height, outer and  
399 inner diameters respectively and  $(P_i, P_2)$  are the gas upstream and downstream pressure  
400 respectively. Typically  $P_2$  is the atmospheric pressure and four to five values of the upstream  
401 pressure (ranging from 0 to 0.4 MPa) are considered. In order to obtain the intrinsic permeability  
402 experimentally, Klinkenberg's formula is implemented:

403

$$404 \quad K_a = K_{in} \left(1 + \frac{\beta}{P_m}\right) \quad (19)$$

405

406 where  $\beta$  is the Klinkenberg's coefficient,  $K_{in}$  is the intrinsic permeability and  $P_m$  is the mean  
407 pressure.  $\beta$  and  $K_{in}$  are obtained from the linear regression of the curve giving the apparent  
408 permeability as a function of the inverse of the mean pressure.

409 The PSD measurements are performed by mercury intrusion (Micromeritics–AutoPore IV). The  
410 analysis is based on the Washburn equation with the assumption that the pores are cylindrical and  
411 connected from the larger pores to the smaller ones. Only the porosity accessible from the outer  
412 surface is taken into account. Bottle neck effects are limited by performing two intrusion cycles.

413

#### 414 *Experimental results*

415 Table 2 presents the mechanical properties of the mortar tested under compression. Figure 8 shows  
416 a typical mechanical response of the specimens for different loading-unloading cycles and Figure 9  
417 shows the evolution of damage computed according to Eq. (17). On the horizontal axis, the stress

418 has been normalized by the peak stress. Figure 10 shows the evolution of pore size distribution of  
419 samples subjected to different mechanical damage (from 0 to 12%). As damage increases, a slight  
420 increase of the PSD is observed between 1,000nm and 3,000nm. Moreover new porosity is created  
421 around 10,000nm. This new porosity leads to the increase of the intrinsic permeability by two  
422 orders of magnitude. This figure illustrates also the necessity to record low-pressure signals during  
423 mercury intrusion. Indeed, as damage develops, micro-cracks form pores with aperture in the range  
424 of the measurement of mercury intrusion under low pressure. These pores are major contributors to  
425 the increase of permeability and ought to be taken into account in the model.

426 The evolution of the intrinsic permeability and Klinkenberg coefficient upon damage are very  
427 similar to those obtained by Choinska et al. (2007) on concrete. They will be compared in the next  
428 section against the model results.

## 429 **COMPARISON BETWEEN EXPERIMENTAL RESULTS AND MODEL** 430 **PREDICTIONS**

431 Figure 11(a) presents the comparison between the measured and computed intrinsic permeability  
432 evolution upon damage from 0% to 12%. The computed values are derived from an average of at  
433 least 5 hierarchical capillary bundles generated for each average PSD with different random seeds.  
434 They are in good agreement with the experimental ones. Note that no tortuosity parameter has been  
435 introduced in the model (tortuosity equals 1). Introducing a tortuosity in the model would not,  
436 however, change drastically the predictions, e.g. by an order of magnitude.

437 The predicted values are compared to the measurements of the permeability obtained under load.  
438 The PSD measurements, which are the only input of the model, are performed after unloading but it  
439 seems that the mercury intrusion may have reopened micro-cracks that were closed upon unloading.  
440 In these conditions, the porous network characterized by mercury intrusion may be closer to the  
441 under-load one than to the unload one.

442 Figure 11(b) shows the evolution of the Klinkenberg's coefficient upon damage. Comparisons  
443 between the experimental and theoretical results are plotted. Once again the agreement is rather  
444 good whatever the damage state and the predicted values are closer to the under-load ones.

445 The model provides rather good predictions in term of apparent permeability to nitrogen. We have  
446 also tested its predictability for other gases. Because their molecular diameter and average free path  
447 are different compared to nitrogen, Knudsen's effect will be different too, yielding (along with  
448 variations of the viscosity) different evolution of the apparent permeability with pressure. For an  
449 undamaged sample, Figure 12 shows the evolution of the apparent permeability to different gases  
450 (CO<sub>2</sub>, CH<sub>4</sub>, N<sub>2</sub>, H<sub>2</sub>) estimated by the model. Table 3 shows the various parameters that enter for  
451 each gas in the model. We observe that the responses of CO<sub>2</sub>, CH<sub>4</sub> and N<sub>2</sub> are similar whereas the  
452 helium response is different. Since the helium mean free path is greater than the nitrogen one,  
453 Knudsen effect is higher for helium and then the slope of the apparent permeability vs. mean  
454 pressure curve is also higher compared to the other gases.

455 Figure 13 shows the comparison between the apparent permeabilities to nitrogen and helium  
456 measured experimentally and computed according to the present model. We observe a good  
457 agreement between the experimental and predicted values, both on the intrinsic permeability and on  
458 the Klinkenberg's coefficient. It is important to notice that when performing the comparisons, no  
459 specific model parameter is set to predict the apparent permeability with the proposed model upon a  
460 change of the nature of the gas.

## 461 **CONCLUSIONS**

462 A **semi-analytical** model aimed at computing the apparent permeability of a porous material to gas  
463 has been presented. The model uses the pore size distribution of the material as an input, including  
464 the low-pressure information obtained from mercury intrusion technique.

465 The porous network is generated according to a hierarchical scheme in which pore segments are  
466 assembled hierarchically, from large diameters of pores to small ones. Within each capillary pore,  
467 fluid flow is described at the micro-scale by a combination of Poiseuille's Flow and Knudsen's

468 (diffusion) flow. The outcome at the macroscopic scale results into a Klinkenberg-type of apparent  
469 permeability, within a Darcy-type equation. The sensitivity of the permeability to the mean pressure  
470 is recovered.

471 The model has been compared with experiments on cylindrical hollow mortar specimens subjected  
472 to uniaxial compression and radial permeation. In the case of permeability to nitrogen, the intrinsic  
473 permeability increases and the Klinkenberg's coefficient are found to decrease experimentally upon  
474 damage. The theoretical model captures these trends very consistently. In addition, the same model  
475 is also capable of predicting the permeability of the material to different gas, without any  
476 adjustment of the model parameters.

477

478 **Acknowledgements:** Financial supports from the *European Research Council* through the ERC  
479 advanced grant Failflow (27769), from the French *Région Aquitaine* through the grant CEPAGE  
480 (20121105002) and from the French *Agglomération Côte Basque – Adour* are gratefully  
481 acknowledged. F. Khaddour is grateful to the Syrian Ministry of Higher Education for its support  
482 (13153/4/W). The authors would like to thank Lionel Ecay for his help.

## 483 **BIBLIOGRAPHY**

484 Aït-Mokhtar, A., Amiri, O., Dumargue, P., and Sammartino, S. (2002). A new model to calculate  
485 water permeability of cement materials from MIP results. *Advances in Cement Research*, Vol.  
486 14(2), 43–49.

487 Amiri, O., Aït-Mokhtar, A., and Sarhani, M. (2005). Tri-dimensional modelling of cementitious  
488 materials permeability from polymodal pore size distribution obtained by mercury intrusion  
489 porosimetry tests. *Advances in Cement Research*, Vol.17(1), 39–45.

490 Arson, C. and Pereira, J.M. (2013). Influence of Damage on pore size distribution and permeability  
491 of rock, *Int. J. Numer. Anal. meth. Geomechanics*, Vol. 37, 810-831.

492 Berndt, E. and Sevostianov, I. (2012). Multiscale modeling of fluid permeability of a non-  
493 homogeneous porous media, *Int. J. Engrg. Sciences*, Vol. 56, 99-110.

494 Blunt, M.J. (2001). Flow in porous media - Pore network models and multiphase flow, *Current*  
495 *Opinions in Colloid and Interface Science*, Vol. 6, 197-207.

496 Blunt, M.J., Jackson, M.D., Piri, M., and Valvatne, P.H. (2002). Detailed physics, predictive  
497 capabilities and macroscopic consequences for pore-network models of multiphase flow, *Advances*  
498 *in Water Res.*, Vol. 25, 1069-1089.

499 Brown, P.W., Shi, D., and Skalny, J.P. (1991). Porosity/permeability relationships, *Material*  
500 *Science of Concrete II*, J. Skalny and S. Mindess Eds., American Ceramic Society, Westerville OH.,  
501 83-109.

502 Chen, W., La Borderie, C., Maurel, O., Pijaudier-Cabot, G., Rey-Betbeder, F. (2014). Simulation of  
503 Damage - Permeability Coupling for Mortar under Dynamic Loads, *Int. Num. Anal. Meth.*  
504 *Geomechanics*, Vol. 38, 457-474.

505 Childs, E.C. and Collis-George, N. (1950). The permeability of porous materials, *Proc. Royal Soc.*,  
506 London, 201A, 392.

507 Choinska, M., Khelidj, A., Chatzigeorgiou, G., and Pijaudier-Cabot, G. (2007). Effects and  
508 Interactions of Temperature and Stress-Level Related Damage on Permeability of Concrete. *Cement*  
509 *Concr. Res.*, Vol. 37, 79-88.

510 Chunsheng, Z., Kefei, L. Xiaoyun, P. (2011). Effect of crack density and connectivity on the  
511 permeability of microcracked solids, *Mech. Mats.*, Vol. 43, 969-978.

512 Darcy, H. (1856). Les fontaines publiques de la ville de Dijon,. *Dalmont, Paris*.

513 Diamond, S. (2000). Mercury porosimetry - an inappropriate method for the measurement of pore  
514 size distributions in cement-based materials, *Cement and Concr. Res.*, Vol. 30, 1517-1525.

515 Dormieux, L., Kondo, D., and Ulm, F.J. (2006). *Microporomechanics*, Wiley Pubs. London U.K.,

516 Grassl, P. (2009). A lattice approach to model flow in cracked concrete, *Cement and Concr.*  
517 *Composites*, Vol. 31, 454-460.

518 Gueguen, Y., and Dienes, J. (1989). Transport properties of rocks from statistics and percolation,  
519 *Math. Geology*, Vol. 21, 1.

520 Hoseini, M., Bindiganaville, V., and Banthia, N. (2009). The effect of mechanical stress on  
521 permeability of concrete: A review, *Cement and Concr. Composites*, Vol. 31, 213-220.

522 Jason, L., Pijaudier-Cabot, G., Ghavamian, S., and Huerta, A. (2007). Hydraulic behaviour of a  
523 representative structural volume for containment buildings, *Nuclear Engrg. Design*, Vol. 237, 1259-  
524 1274.

525 Kast, W., and Hohenthanner, C.-R. (2000). Mass transfer within the gas-phase of porous media.  
526 *International Journal of Heat and Mass Transfer*, Vol. 43(5), 807–823.

527 Katz, A.J. and Thompson, A.H. (1986). Quantitative prediction of permeability in porous rock.  
528 *Physical review*, Vol. 34(11), 8179–8181.

529 Khaddour, F., Grégoire, D., and Pijaudier-cabot, G. (2013). Upscaling Permeation Properties in  
530 Porous Materials from Pore Size Distributions. *Geomechanical Issues in CO2 Storage Facilities*, G.  
531 Pijaudier-Cabot and J.M. Pereira Eds., ISTE Wiley Pubs., London U.K., 44–56.

532 Khaddour, F., Gregoire, D., Pijaudier-Cabot, G. (2014). Computing permeation properties of mortar  
533 from pore size distributions, *Computational Modelling of Concrete Structures - Proc. Euro-C conf.*  
534 held in St. Anton, Austria, N. Bicanic, H. Mang, G. Meschke, and R. de Borst eds., CRC press,  
535 Vol. 1, 405-414.

536 Khaddour, F., Grégoire, D., and Pijaudier-Cabot, G. (2015). Capillary bundle model for the  
537 computation of the apparent permeability from pore size distributions. *European journal of*  
538 *environmental and civil engeneering*, Vol. 19, 168-183.

539 Klinkenberg, L. J. (1941). The permeability of porous media to liquids and to gases. *API Drilling*  
540 *and Production Practice*, 200–213.

541 Kozeny, J. (1927). Ueber kapillare Leitung des Wassers im Boden'. *Wien, Akad. Wiss*, Vol.  
542 136(2a), 271.

543 Li, K., Stroeven, M., Stroeven, P., and Sluys, L.J. (2016). Investigation of liquid water and gas  
544 permeability of partially saturated cement paste by DEM approach, *Cement Concr. Res.*, Vol. 83,  
545 104-113.

546 Miehe, C., Mauthe, S. (2016). Phase field modeling of fracture in multi-physics problems. Part III.  
547 Crack driving forces in hydro-poro-elasticity and hydraulic fracturing of fluid-saturated porous  
548 media, *Computer Methods in Applied Mechanics and Engineering*, Vol. 304, 619-655.

549 Pijaudier-Cabot, G., Dufour, F., Choinska, M. (2009). Permeability Due to the Increase of Damage  
550 in Concrete: From Diffuse to Localised Damage Distributions, *J. Engrg. Mech. ASCE*, 135, 1022 –  
551 1028.

552 Poiseuille, J.L.M. (1840). Physique-Recherches expérimentales sur le mouvement des liquides dans  
553 les tubes de très petits diamètres, Academie des sciences. *Academie des sciences , comptes rendus-*  
554 *in French, 11*, 961–967 and 1041–1048.

555 Rahmanian, M. R., Aguilera, R., and Kantzas, A. (2013). A New Unified Diffusion — Viscous-  
556 Flow Model Based on Pore-Level Studies of Tight Gas Formations. *Society of Petroleum*  
557 *Engineers*, Vol. 18(1), 38–49.

558 Scheidegger, A. E. (1974). The physics of flow through porous media. *University of Toronto Press*.

559 Steckelmacher, W. (1986). Knudsen flow 75 years on: the current state of the art for flow of  
560 rarefied gases in tubes and systems. *Rep. Prog. Phys*, Vol. 49, 1083–1107.

561 Sun, W.C., Andrade, J.E, Rudnicki, J.W. (2011). A multiscale method for characterization of  
562 porous microstructures and their impact on macroscopic effective permeability, *International*  
563 *Journal for Numerical Methods in Engineering*, Vol. 88, 1260-1279.

564 Sun, W.C., Kuhn, M.R., Rudnicki, J.W. (2013). A multiscale DEM-LBM analysis on permeability  
565 evolutions inside a dilatant shear band, *Acta Geotechnica*, Vol. 8, 465-480.

566 Timothy, J.J., and Meschke, G. (2016). A cascade lattice micromechanics model for the effective  
567 permeability of materials with microcracks, *Journal of nanomechanics and Micromechanics, ASCE*,  
568 Vol. 6, NM.2153-5477.0000113.

569 White, J. A., Borja, R. I., & Fredrich, J. T. (2006). Calculating the effective permeability of  
570 sandstone with multiscale lattice Boltzmann/finite element simulations. *Acta Geotechnica*, Vol. 1,  
571 195-209.



572 Wong, H.S., Zimmerman, R.W., and Buenfeld, N.R. (2012). Estimating the permeability of cement  
573 pastes and mortar using image analysis and effective medium theory, *Cement Concr. Res.*, Vol. 42,  
574 476-483.

575 Ziarani, A.S. and Aguilera, R. (2012). Knudsen's permeability correction for tight porous media,  
576 *Transp. Porous Med.*, Vol. 91, 239-260.

577

Table1. Mortar composition.

Ingredient	Water	Cement	Sand	W/C ratio
Quantity (kg/m <sup>3</sup> )	243	412	1651	0.7

Table2. Mechanical properties of mortar.

Modulus of Young (GPa)	Resistance to compression (Mpa)	Strain at peak (%)
20	29	0.21

Table 3. Physical parameters for each gas obtained from NIST database (<http://webbook.nist.gov/chemistry/>)

Type of gas	N <sub>2</sub>	He	CO <sub>2</sub>	CH <sub>4</sub>
Molar mass (kg/mol)	0.0280134	0.0040026	0.0440095	0.0160425
Viscosity (Pa.s)	0.0000174	0.0000199	0.00001469	0.000011026
Molecular diameter (Å°)	3,64	2,6	3,3	3,8

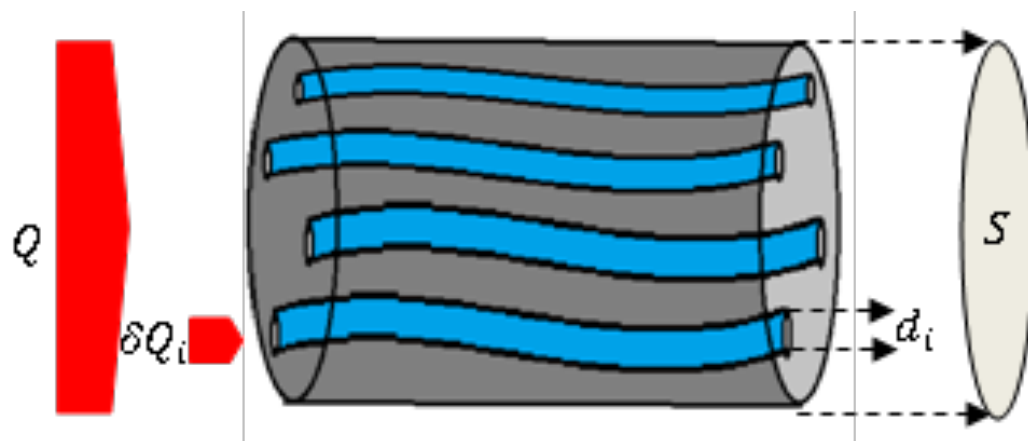
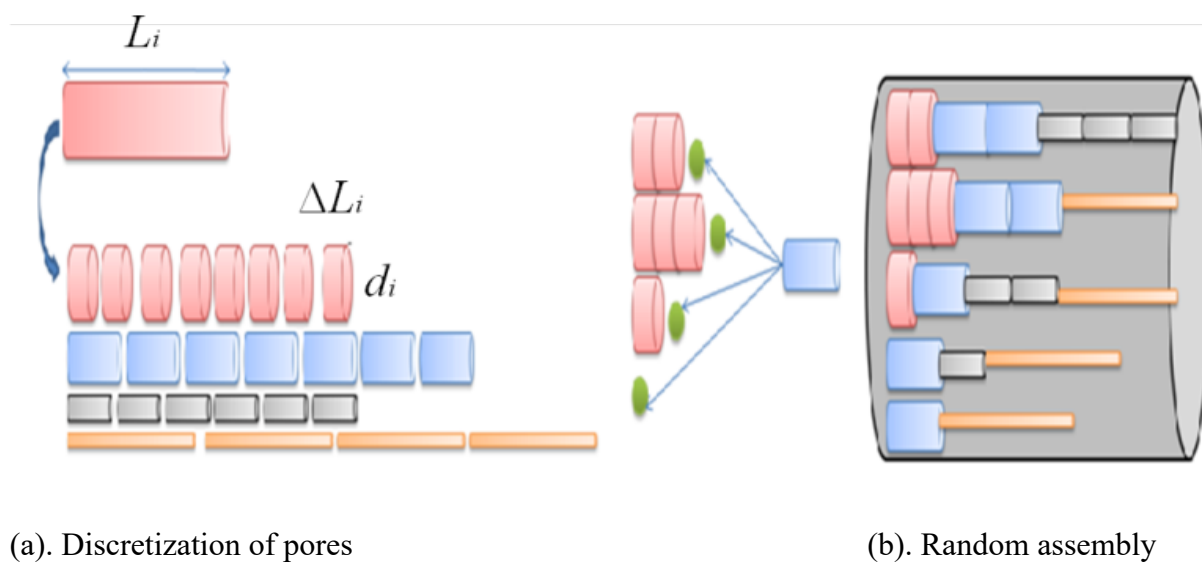

Figure 1. Model of parallel assembly of pores



(a). Discretization of pores

(b). Random assembly

Figure 2. Random network assembly of pores

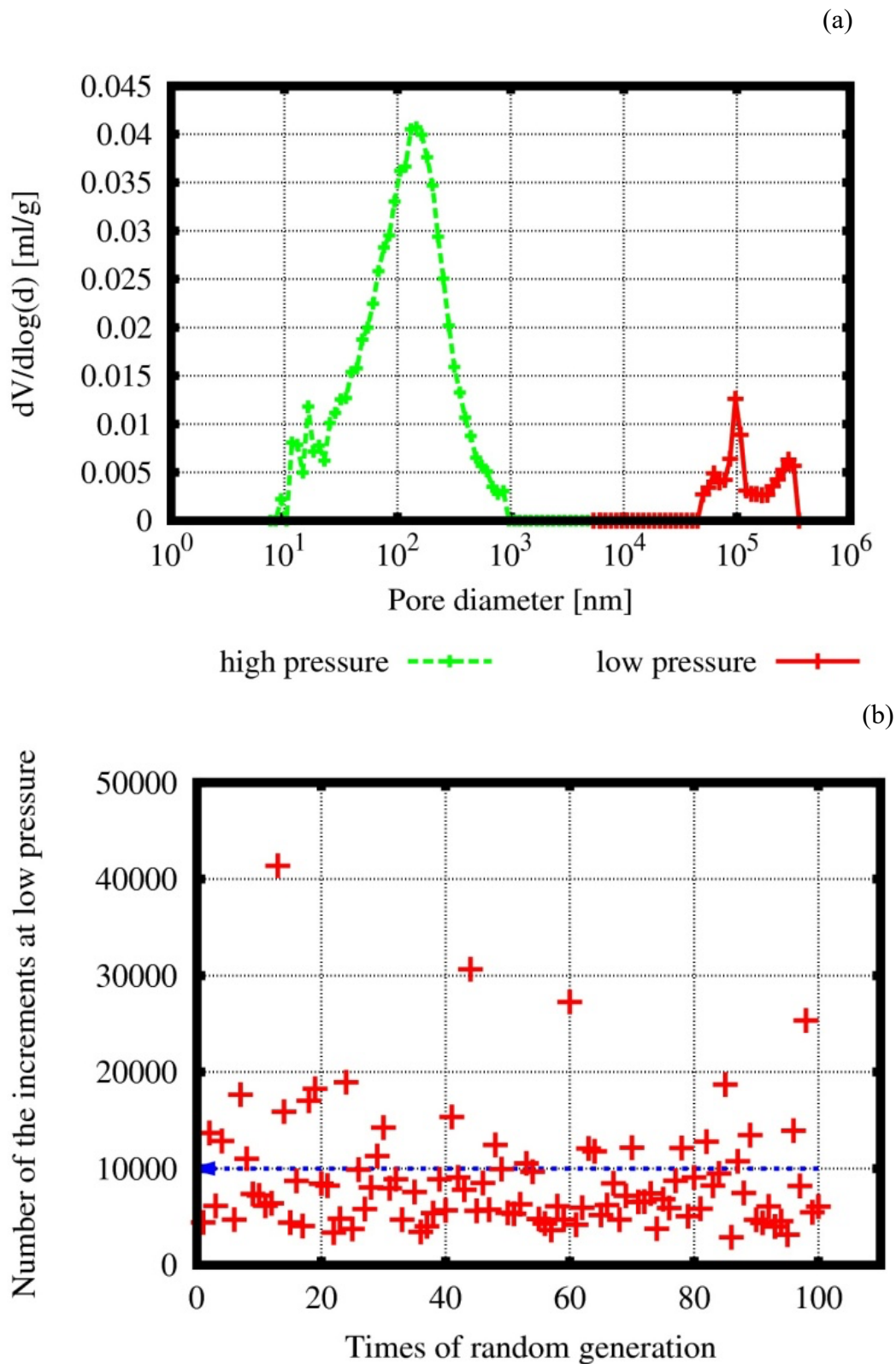

Figure 3. Method of eliminating of the noise at low pressure for an undamaged sample a) pore size distribution corresponding to the low and high pressures b) statistical study of the low frequency for 100 random times

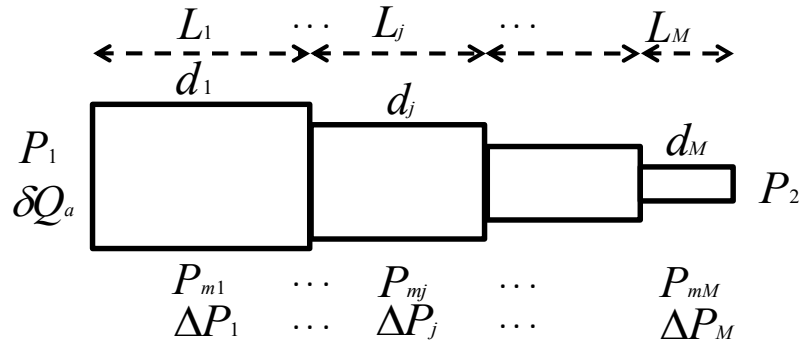

Figure 4. : Capillary made of segments with decreasing diameter

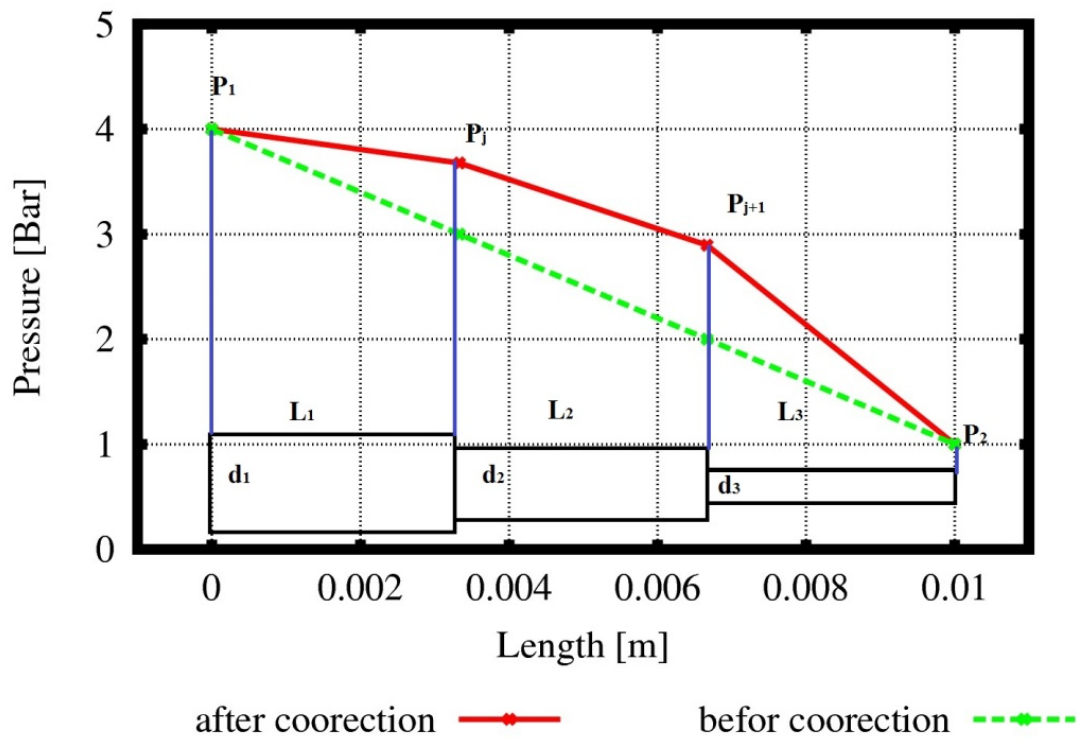

Figure 5. Distribution of pressure in a capillary made of three segments with decreasing diameter at the initial iterative scheme and after convergence.

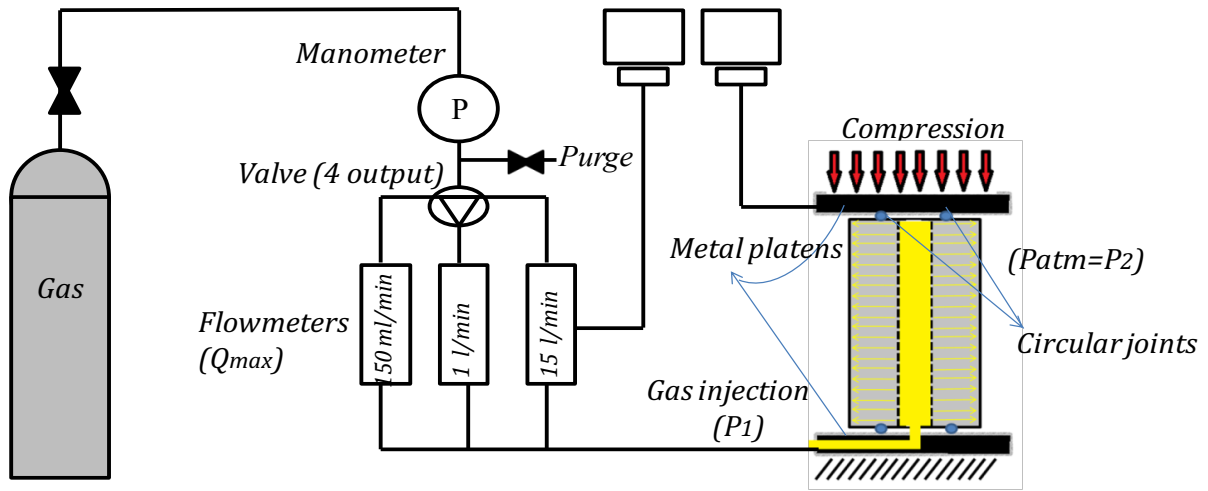

Figure 6. Schematic description of the mechanical and permeability tests

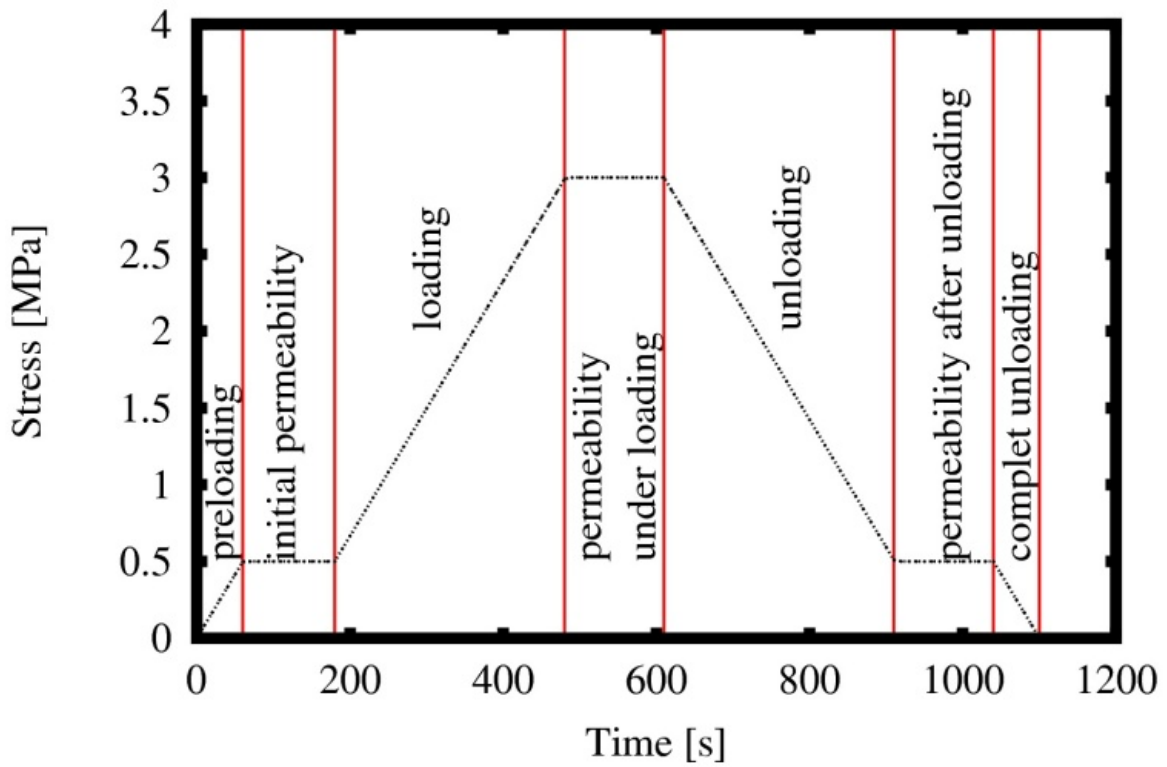

Figure 7. Load vs time curve

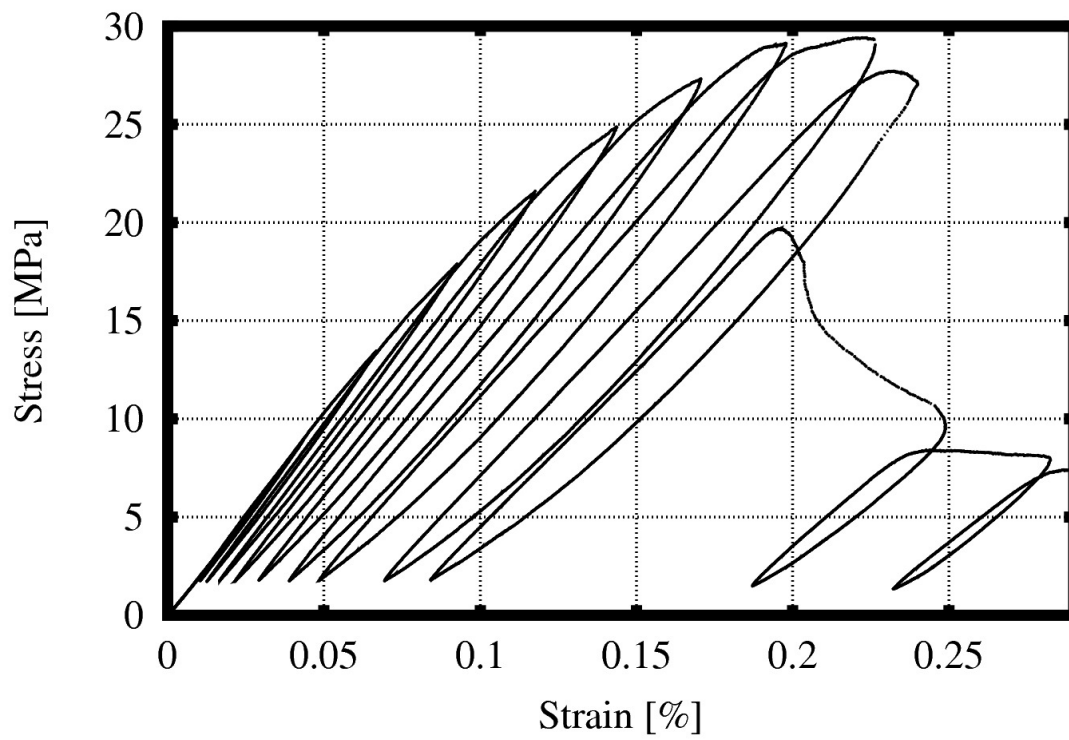

Figure 8. Typical stress-strain curve of a mortar sample

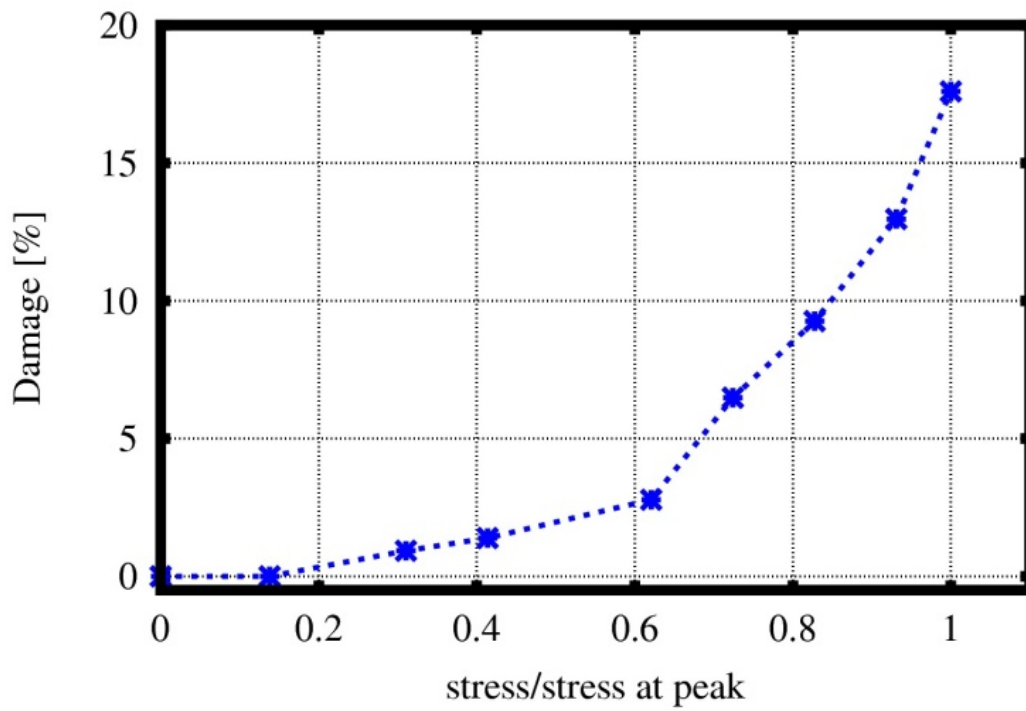

Figure 9. Damage-stress/stress at peak curve of the specimens

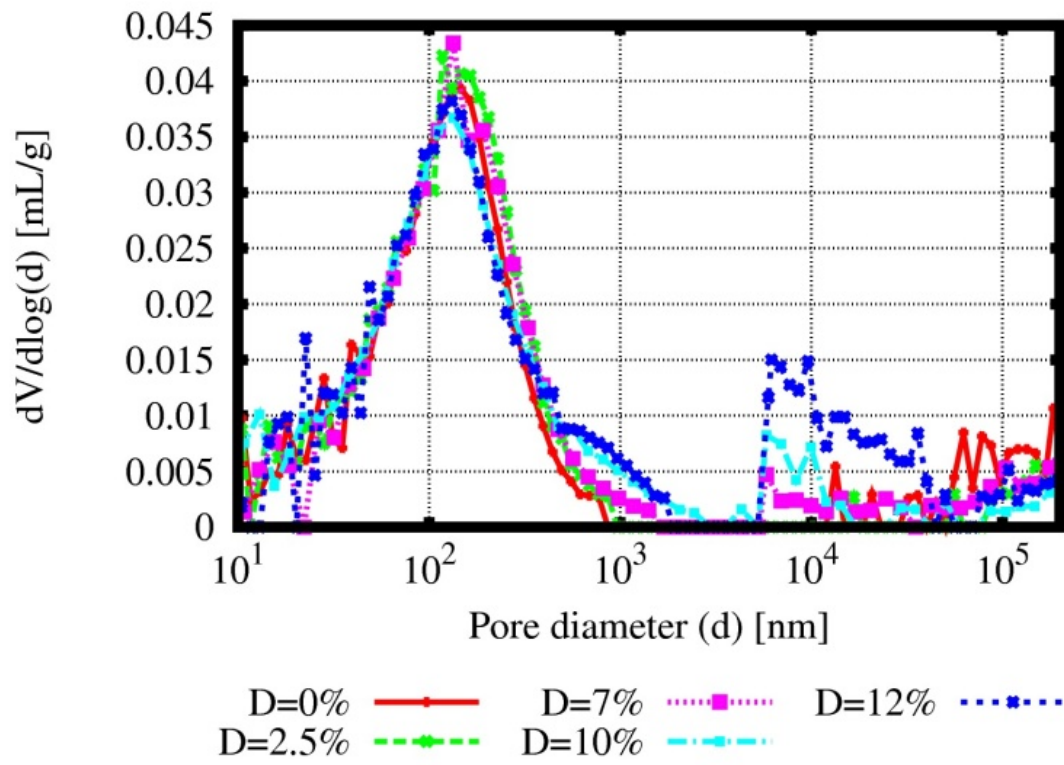
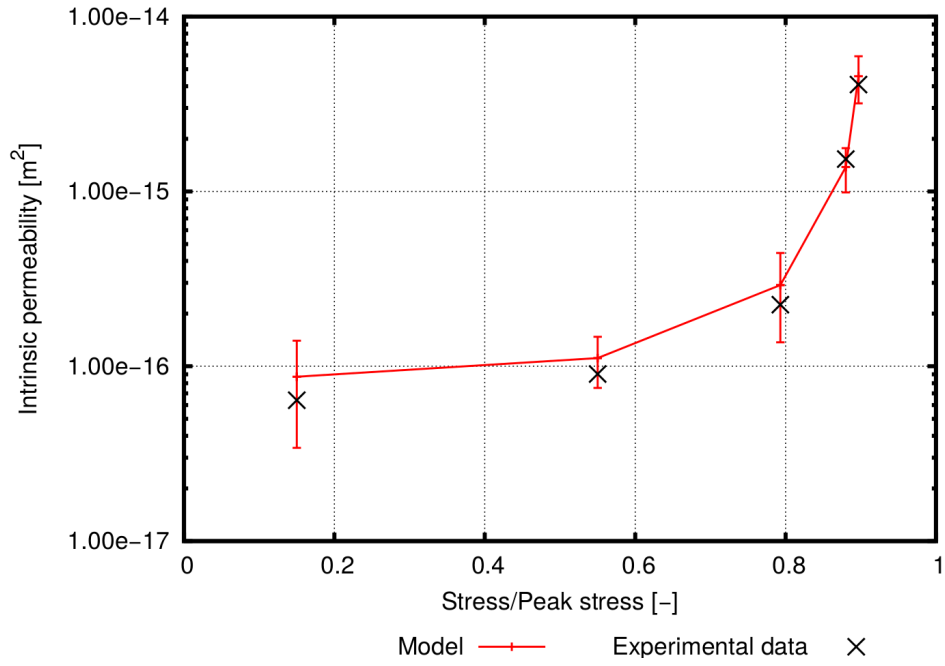
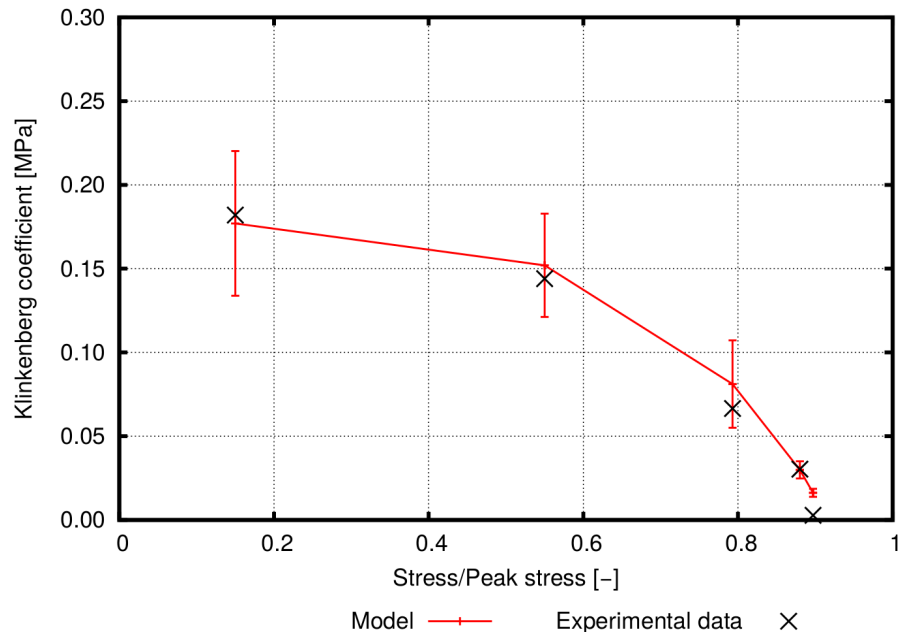

Figure 10. Evolution of pore size distribution upon damage





(a) Intrinsic permeability



(b) Klinkenberg coefficient

Figure 11. Comparison between the intrinsic permeability measured and predicted (a); comparison between the Klinkenberg's coefficient measured and predicts (b).

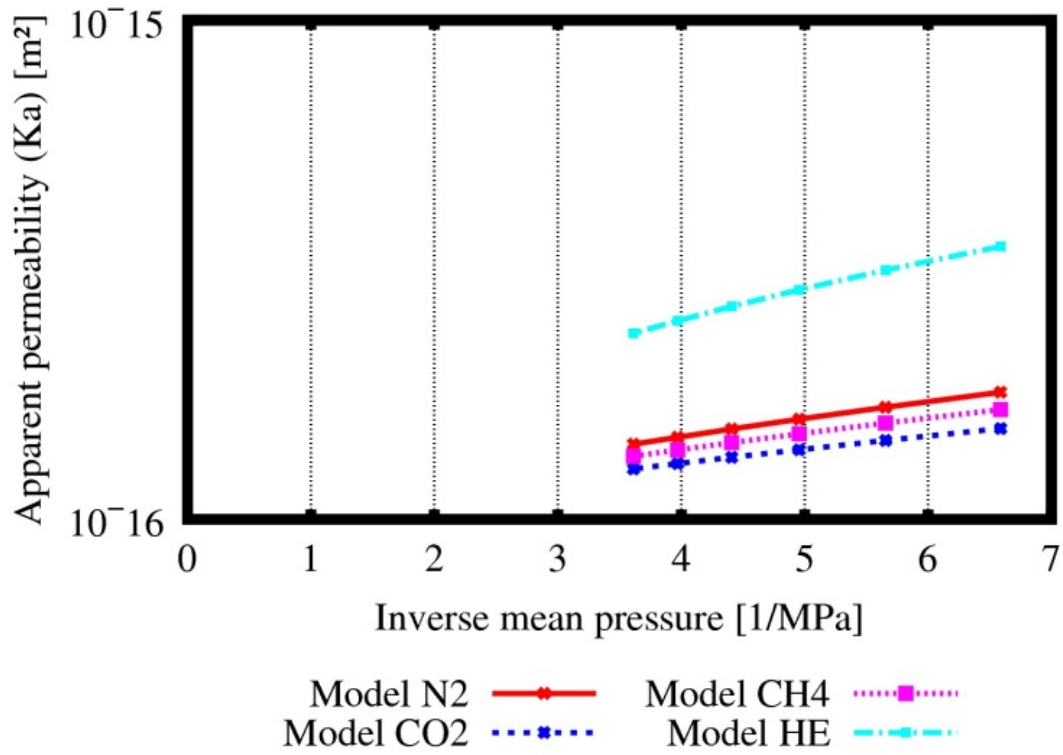

Figure 12. Evolution of the apparent permeability for several gases (CO<sub>2</sub>, CH<sub>4</sub>, N<sub>2</sub>, He)

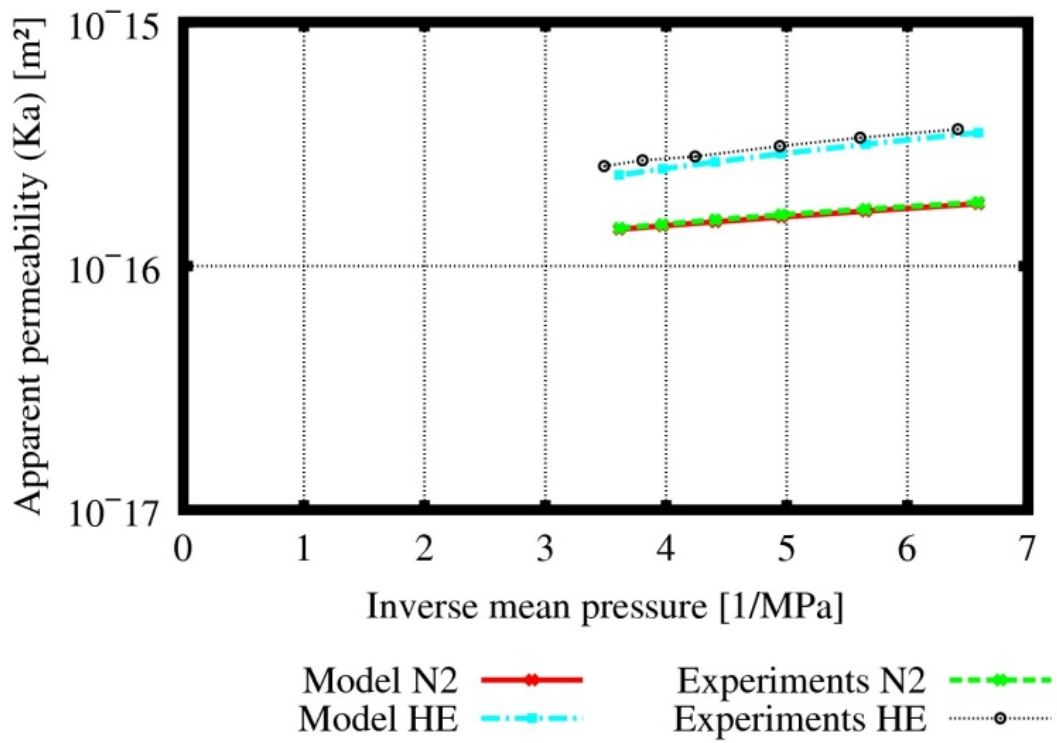

Figure 13. Comparison between the model and the experimental results of apparent permeabilities for N<sub>2</sub> and He.