



**HAL**  
open science

## Surface characterization and influence of anodizing process on fatigue life of Al 7050 alloy

Majid Shahzad, Michel Chaussumier, Rémy Chieragatti, Catherine Mabru, Farhad Rezai-Aria

► **To cite this version:**

Majid Shahzad, Michel Chaussumier, Rémy Chieragatti, Catherine Mabru, Farhad Rezai-Aria. Surface characterization and influence of anodizing process on fatigue life of Al 7050 alloy. *Materials & Design*, 2011, 32 (6), pp.3328-3335. 10.1016/j.matdes.2011.02.027 . hal-01666700

**HAL Id: hal-01666700**

**<https://hal.science/hal-01666700>**

Submitted on 2 Aug 2018

**HAL** is a multi-disciplinary open access archive for the deposit and dissemination of scientific research documents, whether they are published or not. The documents may come from teaching and research institutions in France or abroad, or from public or private research centers.

L'archive ouverte pluridisciplinaire **HAL**, est destinée au dépôt et à la diffusion de documents scientifiques de niveau recherche, publiés ou non, émanant des établissements d'enseignement et de recherche français ou étrangers, des laboratoires publics ou privés.



## Open Archive Toulouse Archive Ouverte (OATAO)

OATAO is an open access repository that collects the work of Toulouse researchers and makes it freely available over the web where possible.

This is an author -deposited version published in: <http://oatao.univ-toulouse.fr/>  
Eprints ID: 4985

To link to this article: DOI: 10.1016/j.matdes.2011.02.027

URL: <http://dx.doi.org/10.1016/j.matdes.2011.02.027>

**To cite this version:** SHAHZAD Majid, CHAUSSUMIER Michel, CHIERAGATTI Rémy, MABRU Catherine, REZAIĀ-ARIA Farhad. Surface characterization and influence of anodizing process on fatigue life of Al 7050 alloy. *Materials & Design*, vol. 32, n° 6, pp. 3328-3335. ISSN 0261-3069

Any correspondence concerning this service should be sent to the repository administrator:  
[staff-oatao@inp-toulouse.fr](mailto:staff-oatao@inp-toulouse.fr)

# Surface characterization and influence of anodizing process on fatigue life of Al 7050 alloy

Majid Shahzad <sup>a,\*</sup>, Michel Chaussumier <sup>a</sup>, Rémy Chieragatti <sup>a</sup>, Catherine Mabru <sup>a</sup>, Farhad Rezai-Aria <sup>b</sup>

<sup>a</sup> Université de Toulouse, Institut Supérieur de l'Aéronautique et de l'Espace (ISAE), Département Mécanique des Structures et Matériaux (ICA), 10-Avenue Edouard Belin, 31055 Toulouse Cedex 4, France

<sup>b</sup> Université de Toulouse, Ecoles des Mines d'Albi (ICA), Campus Jarlard, F-81013 Albi, France

## A B S T R A C T

The present study investigates the influence of anodizing process on fatigue life of aluminium alloy 7050-T7451 by performing axial fatigue tests at stress ratio 'R' of 0.1. Effects of pre-treatments like degreasing and pickling employed prior to anodizing on fatigue life were studied. The post-exposure surface observations were made by scanning electron microscope (SEM) to characterize the effect of each treatment before fatigue testing. The surface observations have revealed that degreasing did not change the surface topography while pickling solution resulted in the formation of pits at the surface. Energy dispersive spectroscopy (EDS) was used to identify those constituent particles which were responsible for the pits formation. These pits are of primary concern with respect to accelerated fatigue crack initiation and subsequent anodic coating formation. The fatigue test results have shown that pickling process was detrimental in reducing the fatigue life significantly while less decrease has been observed for anodized specimens. Analyses of fracture surfaces of pickled specimens have revealed that the process completely changed the crack initiation mechanisms as compared to non-treated specimens and the crack initiation started at the pits. For most of the anodized specimens, fatigue cracks still initiated at the pits with very few cracks initiated from anodic coating. The decrease in fatigue life for pickled and anodized specimens as compared to bare condition has been attributed to decrease in initiation period and multi-site crack initiations. Multi-site crack initiation has resulted in rougher fractured surfaces for the pickled and anodized specimens as compare to bare specimens tested at same stress levels.

### Keywords:

C. Surface treatments

E. Fatigue

G. Scanning electron microscopy (SEM)

## 1. Introduction

High strength to weight ratios make aluminium alloys, specially 2000 and 7000 series, attractive to be used in aeronautical industry for different structural components. In aeronautical applications, an important aspect to take into consideration is the fatigue behaviour of the structures due to the influence of fluctuating loads [1]. Being subjected to different environmental conditions (for the aeronautical structures) corrosion resistance of the materials used is also an important aspect to be taken into account. To prevent the corrosion failure and enhance the corrosion resistance, anodizing is the most typical process used for aluminium alloys [2]. Despite the benefits obtained in terms of enhanced corrosion properties, the anodizing process has a damaging effect on the fatigue performance of the base material [3–7] with the main effect being the encouragement of crack initiation. The anodization produces a brittle and hard oxide layer as compared to aluminium substrate with inherent pores and it easily cracks under cyclic stress [8].

Since oxide layer adheres extremely well to substrate, any crack that develops in it acts like stress raiser and propagates towards the substrate.

Prior to anodizing, the appropriate pretreatment of the surface is necessary which comprised of degreasing and pickling and the objective is to produce chemically clean surface ready to be anodized. Localized corrosion, in the form of pits, occurs during the pre-treatment solution exposure and these pits have been identified as cause for accelerated crack nucleation during subsequent fatigue loading [9,10]. Abramovici et al. [11] have shown that changing the pickling time had a great influence on the fatigue life of 7000 series. In a recent study for 7010 alloy, Shahzad et al. [12] have shown that pickling process resulted in the formations of pits by attacking the constituent particles at the surface with significant fatigue life implications.

In the presence of these surface defects, fatigue failure of a component can be greatly accelerated, so an inclusive understanding of these pre-treatments on localized corrosion mechanism is therefore of scientific interest. In this context, the objective of present paper is to quantify the effect of each surface treatment individually and their combined effects on fatigue life of the given alloy.

\* Corresponding author. Tel.: +33 5 61 33 91 48; fax: +33 5 61 33 90 95.  
E-mail address: majid.shahzad@isae.fr (M. Shahzad).

Moreover, constituent particles sizes and distributions can be different for longitudinal  $L$ , long transverse  $T_L$  and short transverse  $S_T$  directions, thus localized corrosion behaviour can be different for each treatment. However, in this article specimens have been machined in the long transverse ' $T_L$ ' direction and subsequent fatigue strength has been evaluated. Optical and scanning electron microscope coupled with energy dispersive spectroscopy were used to study the effect of each treatment on surface topography and fracture surfaces of fatigue specimens to identify the crack origin sites and to understand the damage mechanism.

## 2. Experimental details

### 2.1. Material

The material investigated during this study is 7050-T7451 whose chemical composition, as determined by EDS technique, is given in Table 1. T7451 treatment consists of heat-treating, quenching and overaging [13] for improved fracture toughness and minimal loss of tensile strength.

Metallographic analysis of the microstructure by optical microscope revealed that it is composed of unrecrystallized and recrystallized grains and latter are elongated in the rolling direction as shown in Fig. 1. Three types of constituent particles were found in this material:  $Al_7Cu_2Fe$ ,  $Al_2CuMg$  and  $Mg_2Si$  as determined by EDS and their average size varied between 8 and 12  $\mu m$ .

Mechanical properties of the alloy determined by tensile tests are; yield strength 448 MPa and 440 MPa, ultimate tensile strength 507 MPa and 504 MPa, elongation 12% and 11.4% in  $L$  and  $T_L$  directions respectively.

### 2.2. Specimen preparation

Fatigue test specimens, as shown in Fig. 2, have been machined with initial surface roughness  $R_a = 0.6 \pm 0.1 \mu m$  by lathe turning, without using lubricant, with the loading axis along the long

**Table 1**  
Chemical composition of 7050-T7451 alloy.

Element	Si	Fe	Cu	Mn	Mg	Ti	Zn	Zr	Al
wt.%	0.28	0.19	1.76	0.07	2.42	0.06	6.15	0.14	Bal.

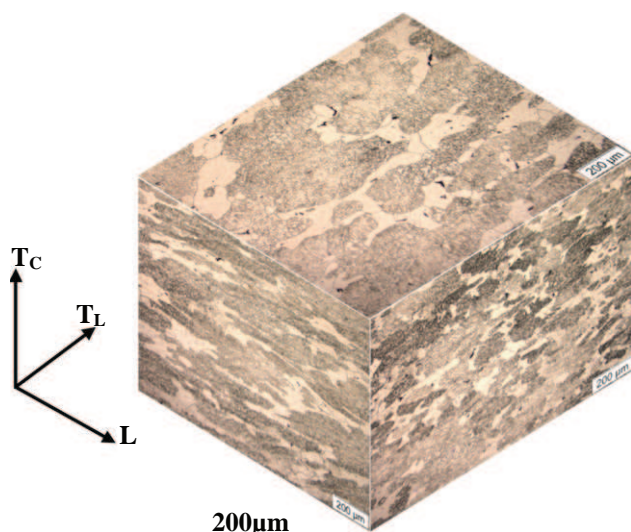

**Fig. 1.** Optical micrograph of 7050-T7451 alloy microstructure.

transverse ( $T_L$ ) direction of the 7050 plate. Stress concentration factor ' $K_t$ ' of the specimen is 1.04 [14].

### 2.3. Surface treatments

Prior to anodizing, the specimens were initially degreased manually by diestone followed by degreasing in alkaline bath (pH  $\sim 9$ ) at  $60 \pm 5 \text{ }^\circ C$  during 3 min followed by water rinsing for 1–2 min. For pickling process, specimens were submerged in aqueous solution of  $H_2SO_4$  (10–15% by weight),  $HNO_3$  (20–30% by weight) and ferric-sulphate  $Fe_2(SO_4)_3$  (20–30% by weight) for 3 min at  $32 \pm 2 \text{ }^\circ C$  followed by 1–2 min water rinsing. Anodizing was carried out in chromic acid  $CrO_3$  solution (55 g/L) at  $40 \pm 2 \text{ }^\circ C$  for 50 min followed by water rinsing.

The thickness of anodic film was measured by optical microscopy and was also confirmed by SEM inspection. The average thickness of film produced by the process is measured to be about 3  $\mu m$ .

### 2.4. Surface measurements

Besides the observations made by SEM, to characterize the effect of each surface treatment quantitatively, topography measurements were carried out with the help of a contact profilometer coupled with motorized table. To do so rectangular specimens of dimension  $40 \times 40 \text{ mm}^2$  were machined with the help of a shaper to give same surface roughness ' $R_a$ ' values as generated for fatigue specimens machined by lathe. After machining, the specimens were subjected to different surface treatments. Several measurements adjacent to each other were done with zone size of  $4 \times 4 \text{ mm}^2$  each with transverse and longitudinal resolutions of 5  $\mu m$  in each direction. The characterization of pits was done with a specific program developed for this purpose. From surface topography data, a plane orientation correction was made using the least square method and pits were initially neglected in this step. Then, surface profile, calculated from machining condition, is subtracted from the real surface measured by profilometer to define the depth of pits.

### 2.5. Fatigue testing

Axial fatigue tests have been performed at 10 Hz in ambient conditions at stress ratio ' $R$ ' of 0.1 according to ASTM E 466 [15]. All tests were conducted under load controlled condition using a 100kN servo-hydraulic MTS machine. The nominal maximum cyclic stress was set at a value that was expected to result in a fatigue life of between  $10^4$  and  $10^6$  cycles and tests were stopped if the specimen did not fail at  $1.2 \times 10^6$  cycles.

## 3. Results and discussions

### 3.1. Characterizing the effects of pre-treatments

Microscopic examination was made after degreasing and pickling process to verify if these pre-treatments affect the surface topography of the specimen. By comparing micrographs Fig. 3a and b before and after degreasing process, we concluded that degreasing process did not change the surface topography of the specimens. Moreover, EDS analysis showed that the constituent particles; i.e.  $Al_7Cu_2Fe$ ,  $Al_2CuMg$  and  $Mg_2Si$  were always present after the degreasing treatment. On the contrary, after the pickling solution exposure, numbers of pits were observed at the surface of the specimen. The pickling process was found to attack the constituent particles resulting in pits formations (Fig. 3c and d). During SEM examination of the pickled specimens, it was observed that some particles were completely dissolved while others were

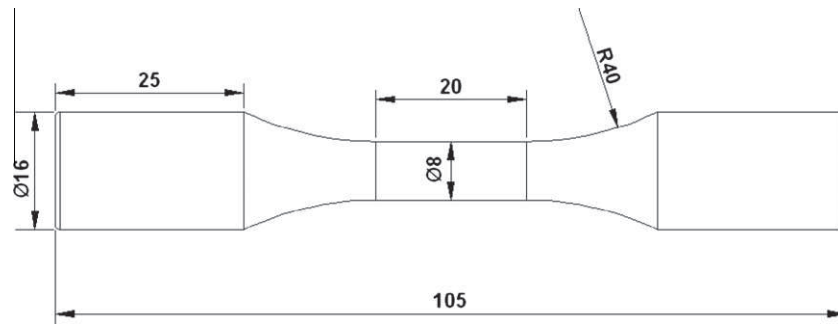

Fig. 2. Fatigue specimen geometry (dimensions in mm).

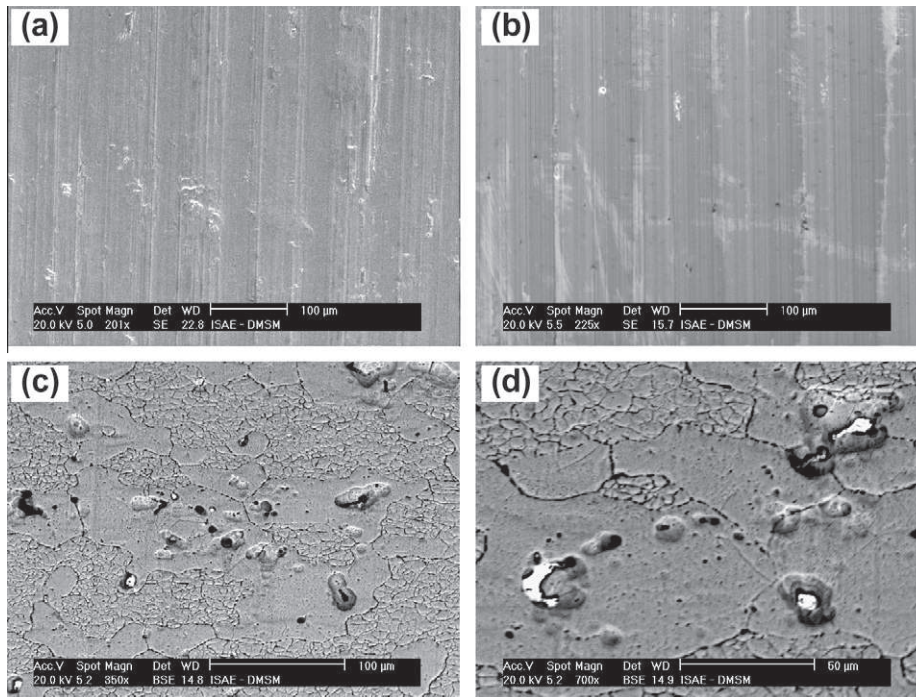

Fig. 3. (a) SEM micrograph of the surface of machined specimen, (b) SEM micrograph of the specimen undergone degreasing only, (c) formation of pits at the surface of specimen subjected to pickling process and (d) dissolution of constituent particles to various extents.

partially dissolved leaving behind a trace (Fig. 3d). This phenomenon has also been reported earlier [16]; Birbilis et al. have shown that nature of the constituent particle had an influence on the pitting process. EDS analysis of some partially dissolved particles showed that these were particles rich in Cu and Fe; i.e.  $Al_7Cu_2Fe$  and  $Al_2CuMg$ .

Fig. 4 presents the results of topography measurements taken for specimen that has undergone the pickling treatment. Here we can observe that most of the pits have depth below  $8 \mu m$  with very few exceeding this value. The possible reason for this phenomenon, as observed by SEM, that some particles were partially dissolved leaving behind the remnants. In their work for aluminium alloys, Ezuber et al. [17] have shown that pit morphology depends on the type of constituent particles present and their reactivity with the exposed solution.

### 3.2. SEM observations of anodic coating

It is of scientific interest to study the effect of these pre-existing defects formed on the specimen surface during pretreatment solution exposure prior to the anodizing step. In Fig. 5, surface observa-

tions made by SEM are shown for specimens undergone the anodization process. It can be clearly seen that anodization tend to form a smooth anodic coating with few pits still present at the surface (Fig. 5). These pits can act as stress raiser during fatigue loading and can significantly affect the fatigue life by reducing or even eliminating the initiation period. On the contrary to pickled specimens, no traces of partially dissolved particles were found for specimens that undergone complete anodization process. This phenomenon can be explained by the complete dissolution of remnant particles, left after pickling solution exposure, during anodizing process.

In Fig. 6 distribution of depth of pits measured by topography is given for the anodized specimens. Here we can observe that size of the largest pit observed has been increased as compared to the pits observed for pickled specimens which can be explained by the complete dissolution of constituent particles. In a recent investigation for aluminium alloy 7075, Savas and Earthman [18] studied the effects of different anodizing pretreatment solutions on localized corrosion behaviour. They hypothesized that if pits, initiated during pretreatment solution exposure, were beyond a threshold size ( $10-20 \mu m$ ), a higher current density existed at these locations

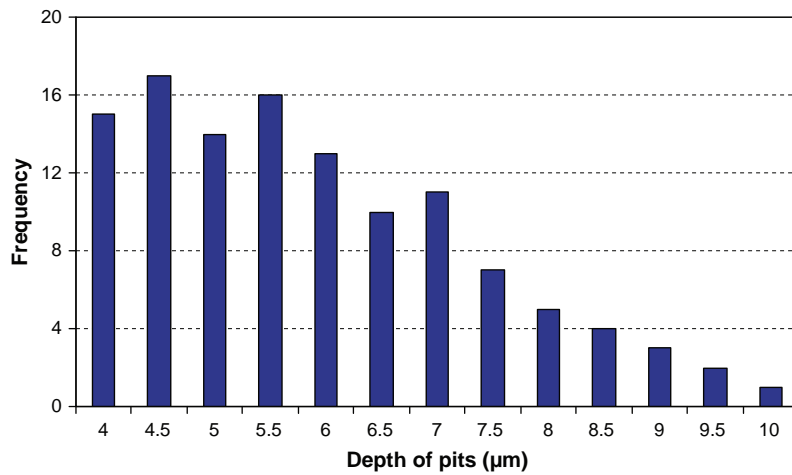

Fig. 4. Distribution of depth of pits formed after pickling solution exposure (topography measurements for a zone of  $4 \times 4 \text{ mm}^2$ ).

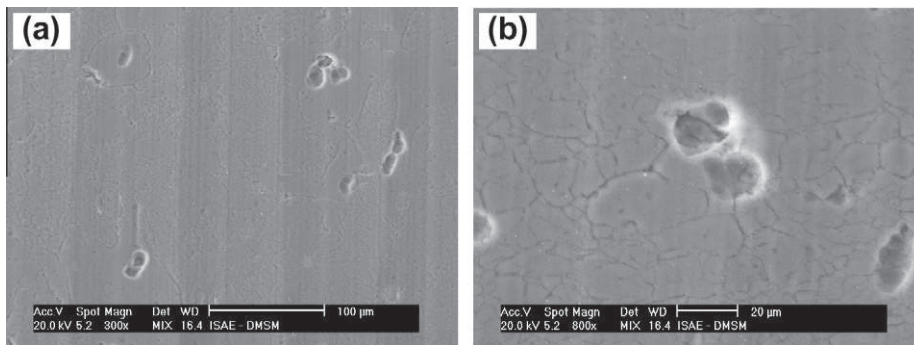

Fig. 5. (a) Surface appearance of specimen after complete anodization cycle and (b) larger pits resulted as complete dissolution of particles.

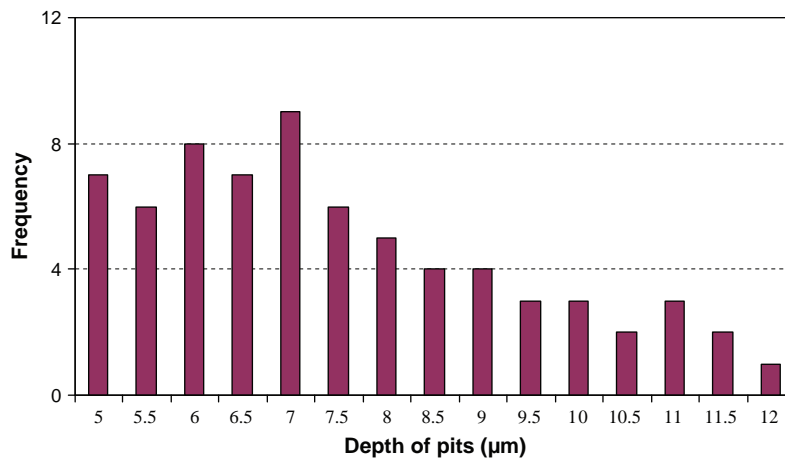

Fig. 6. Distribution of pit depths resulted as complete anodization process (topography measurements for zone of  $4 \times 4 \text{ mm}^2$ ).

during anodizing process, thus resulting in deeper pit structure. During this study, the maximum pit depth was determined to be  $12 \mu\text{m}$  by topography measurements for anodized specimens.

### 3.3. S-N curves

To further validate the fact that degreasing has no effect on fatigue behaviour of this alloy, some specimens were tested after

degreasing solution exposure and results showed no change in the fatigue life as compared to machined specimens. Fatigue test results for machined and pickled specimens are given in Fig. 7 and from the graph it is possible to evaluate the influence of pickling treatment by taking machined specimens as reference. It can be clearly seen that tendency of pickling process is to degrade the fatigue performance of the given alloy at all stress levels as compare to machined specimens. The presence of pits at the

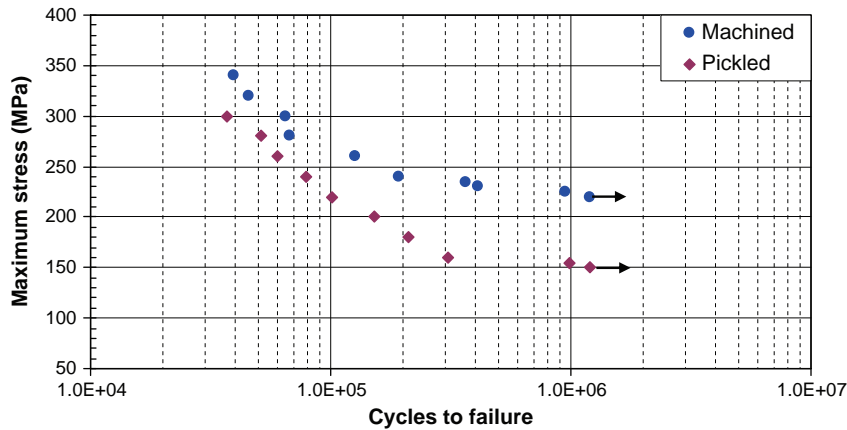

Fig. 7. Fatigue test results for machined and pickled specimens.

surface facilitates cracks initiation and as expected, decrease in the fatigue life of pickled specimens increases with the decrease of fatigue stress. The fatigue strength drops from 220 MPa for the machined specimens to 150 MPa for pickled specimens. The surface topography submitted to pickling treatment, shown in Fig. 3 before any fatigue loading, helps in understanding the strong effect of the process on fatigue strength for this alloy. In the Fig. 3, it is possible to observe many pits which resulted as dissolution of  $Al_7Cu_2Fe$  and  $Al_2CuMg$  particles during pickling solution exposure. These pits can act like stress concentration and can accelerate the crack initiation mechanism in the material.

In case of anodized specimens, fatigue strength decreased from 150 MPa to 125 MPa as compared to pickled specimens for high cycle regime. By taking machined specimens as reference, 43% decrease has been observed for specimens after complete anodization cycle of which 32% decrease has been associated to pickling process (see Fig. 8). This small decrease of fatigue strength for anodizing as compared to pickling can be attributed to slight increase in pit size and brittle nature of oxide coating.

### 3.4. Fatigue fractographic analysis

Several specimens tested at different stress levels were examined after failure by SEM, using backscattered and secondary electrons, in order to understand the different fatigue damage mechanisms for machined, pickled and anodized conditions.

Fatigue test results presented above indicate that the decrease in fatigue strength for pickled and anodized specimens was related to the crack initiation stage. Therefore, it is important to identify the origin of fatigue cracks for different specimens. For aluminium alloys, constituent particles and grain boundaries are the common sites for fatigue crack initiation [19]. For the specimens tested in as machined state, fatigue cracks have been observed to nucleate at constituent particles  $Mg_2Si$  and  $Al_7Cu_2Fe$  particles as determined by EDS analysis while  $Al_2CuMg$  particles were not effective in initiating cracks. It was found that for a given specimen if crack initiation originated at  $Mg_2Si$  particle, it always started by the cracking of the particle and then crack propagated in matrix as shown in Fig. 9.

On the other hand, for  $Al_7Cu_2Fe$  particles, crack initiation always started at the interface of the particle and matrix as shown in Fig. 10. No cracking of the constituent particle or debonding was found at the crack initiation sites. The nucleation site was observed to quickly form a semi-elliptical surface crack approximately double the size of the constituent particle.

For pickled specimens, fatigue cracks were found to initiate at the pits formed by the dissolution of the Cu rich particles, i.e.  $Al_7Cu_2Fe$  and  $Al_2CuMg$  as shown in Fig. 11. These pits may cause local stress concentration and may have a provocative effect on the subsequent cracks growth in the matrix. The fractographic examination of pickled specimens revealed that most of the pits which were found to initiate fatigue cracks was more than 8  $\mu m$

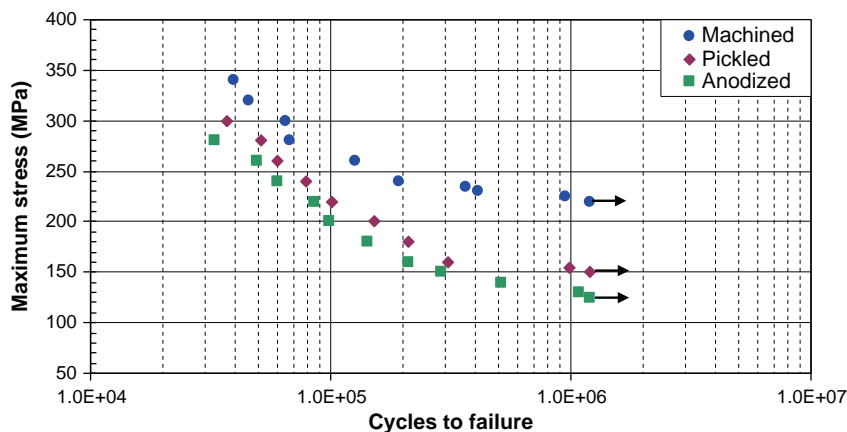
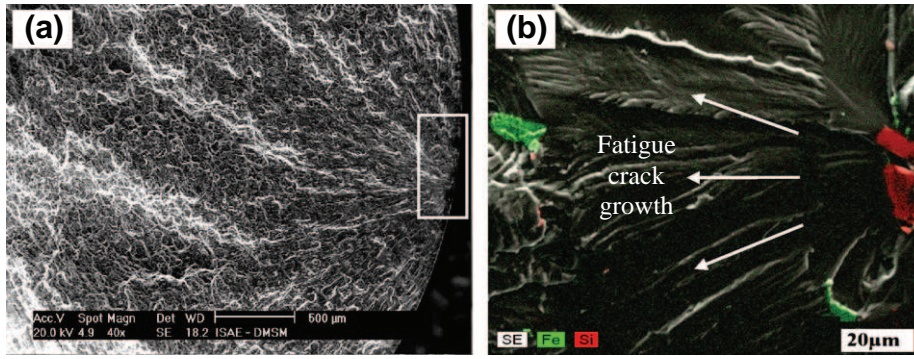
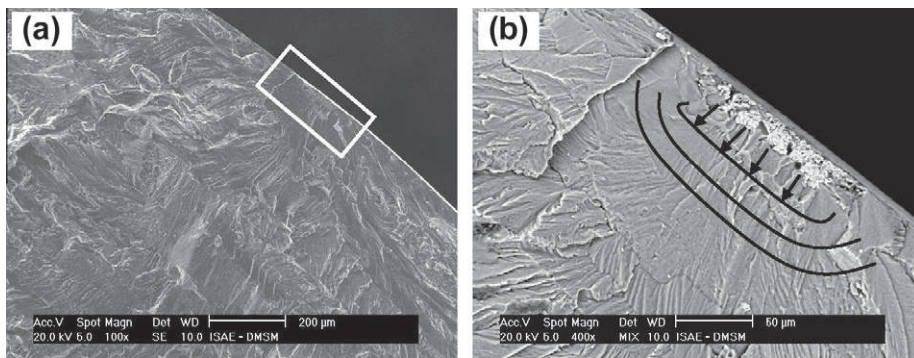

Fig. 8. Fatigue test results for as machined, pickled and anodized specimens.



**Fig. 9.** (a) SEM image for machined specimen at low magnification showing crack initiation site and (b) EDS analysis of (a) showing cracking of  $Mg_2Si$  particle and subsequent crack growth.



**Fig. 10.** Fracture surfaces of machined specimen, at low and high magnification showing fatigue crack initiated by  $Al_7Cu_2Fe$  particle and subsequent crack growth.

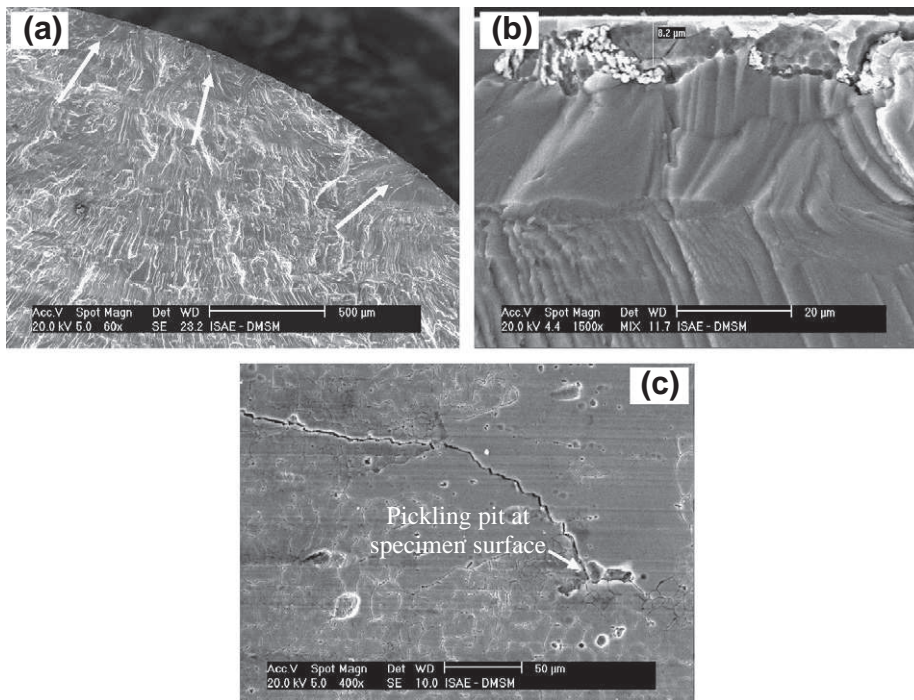
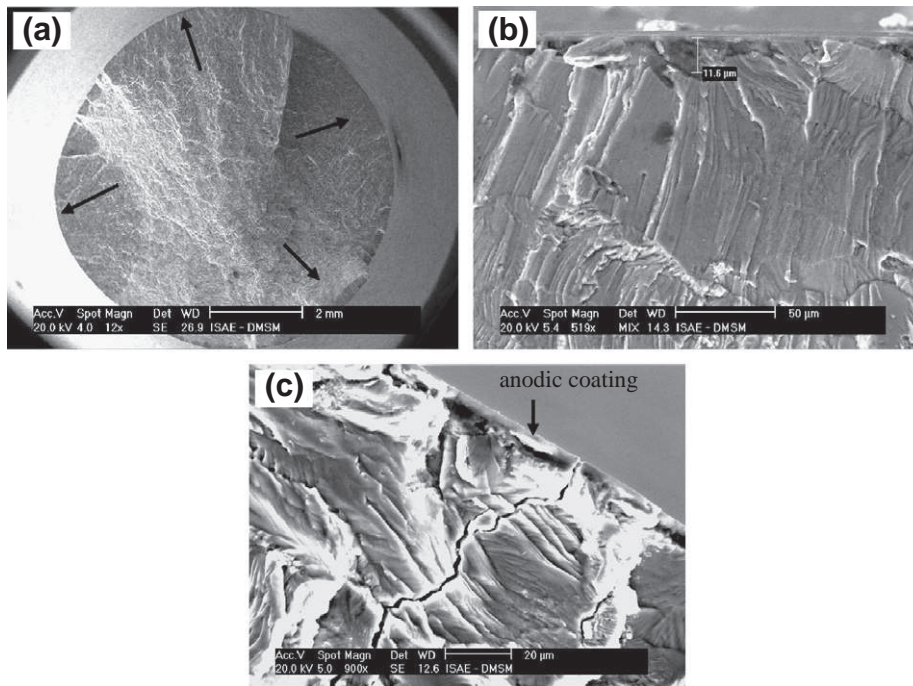

**Fig. 11.** SEM images of pickled specimens: (a) multi-site initiation and cracks coalescence, (b) crack initiation starting from pit and (c) SEM image showing secondary crack on surface.

deep (Fig. 11b). Although there were few pits which were beyond  $8 \mu m$  depth, as determined by topography (Fig. 4) measurements,

the fractography revealed that fatigue failure process exploits the deep pits existing on the specimen surface.





**Fig. 12.** (a) Multi-site crack initiation for anodized specimen, (b) SEM image showing crack initiation from pickling pit and (c) cracking from anodic coating and subsequent crack growth to substrate.

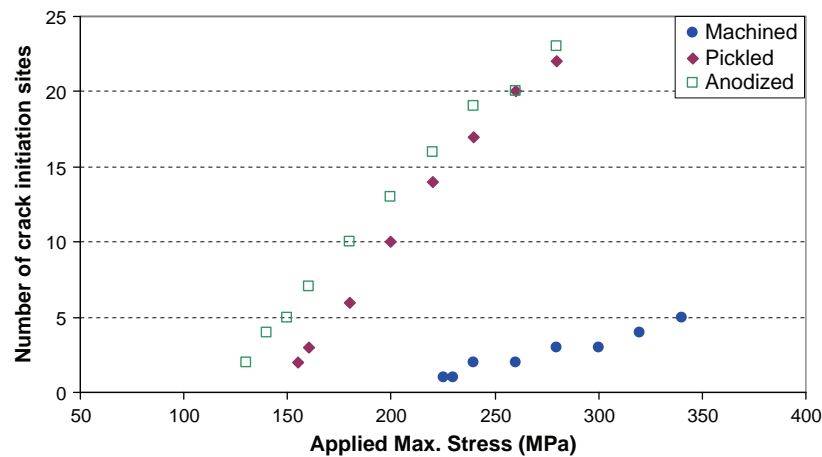

**Fig. 13.** Number of initiation sites as function of max. stress for three different conditions.

In some cases, where two pits were close to each other, initiated cracks grew together to form single crack front as shown in Fig. 11a. Presence of the many pits on the surface also explains multi-crack initiation sites for the specimens which were treated with pickling solution. Some pickled specimens were observed at the surface to show that fatigue cracks are initiated from the pits (Fig. 11c).

Similar to pickled specimens, multiple crack nucleation sites were also found on the fractured surface of the anodized specimens. When analyzed thoroughly by SEM, it was found that almost all fatigue cracks for anodized specimens were initiated by pickling pits beneath the coating as shown in Fig. 12b while very few initiated in the coating and then propagated towards the substrate (Fig. 12c). Relatively small decrease in fatigue strength for anodized specimens as compared to pickled specimens, as shown by

fatigue test results, can be explained in terms of fatigue crack initiation mechanism. Since for anodized specimens, crack initiation mechanism remains the same; i.e. fatigue initiation always started by the pickling pits. As compared to pickled specimens, the depth of pits which were found to initiate fatigue cracks in anodized specimens is 11  $\mu\text{m}$  or more.

At same stress level, the numbers of cracks formed on fractured surface of the pickled and anodized specimens were larger than that of the machined specimens (Fig. 13). The fracture surface is not flat (Fig. 12a) which also reveals that number of fracture steps exists, indicating that fracture has occurred as a consequence of the propagation of several cracks that initiated from pits. This multi-crack initiation is also responsible for rough fractured surface of the anodized specimen. Shiozawa et al. [20] have also demonstrated this phenomenon that number of crack initiation sites

increased after the anodizing treatment. For the pickled and anodized specimens, cracks at the multiple initiation sites propagated independently and coalesce with neighbouring cracks. Therefore, one can also conclude that decrease in fatigue strength for specimens after surface treatments is caused by the increase in number of crack initiation sites and crack propagation rates due to coalescence of cracks.

#### 4. Conclusions

The fatigue strength of 7050 aluminium alloy has been evaluated for different surface treatments. The SEM micrographs of pickled and anodized specimens have revealed the presence of pit like defects at surface before any fatigue loading. These pits were formed as a result of dissolution of constituent particles ( $Al_7Cu_2Fe$  and  $Al_2CuMg$ ) during different solution exposure. Topographical measurements were made to determine the size of these pits. The fatigue test results indicated that pickling and anodizing processes reduce the fatigue strength of the base material and this could be attributed to surface pits which can facilitate an early fatigue crack initiation and accelerate subsequent crack growth.

In as machined condition, fractographic examination showed that crack initiation has been associated with constituent particles  $Mg_2Si$  and  $Al_7Cu_2Fe$ . While for pickled specimens damage mechanism was associated with pit initiation and most of the pits found to initiate cracks were more than 8  $\mu m$  deep. The microscopic aspect of fracture surface for anodized specimen has shown a dual micro-mechanism of failure, with almost all crack initiation sites started from pits while very few were found to start from anodic coating. The decrease in fatigue life could also be attributed to the increase number of crack initiation sites. The fracture surface was not flat, revealing the presence of a number of fracture steps, which points out that fracture has occurred as a consequence of the propagation of several cracks that initiated from surface of the specimens.

#### References

- [1] Fatigue design of aluminium components and structures. 1st ed. In: Sharp ML, Nordmark GE, Menzemer CC. McGraw-Hill Professional; 1996.
- [2] ASM Handbook. Corrosion. 9th ed, vol. 13. USA: ASM International; 1998.
- [3] Lonyuk B, Apachitei I, Duszczyc J. The effect of oxide coatings on fatigue properties of 7475-T6 aluminium alloy. *Surf Coat Technol* 2007;201:8688–94.
- [4] Sadeler R. Effect of a commercial hard anodizing on the fatigue property of a 2014-T6 aluminium alloy. *J Mater Sci* 2006;41:5803–9.
- [5] Rateick RG, Binkowski TC, Boray BC. Effect of hard anodize thickness on the fatigue of AA6061 and C355 aluminium. *J Mater Sci Lett* 1996;15:1321–3.
- [6] Cirik E, Genel K. Effect of anodic oxidation on fatigue performance of 7075-T6 alloy. *Surf Coat Technol* 2008;202:5190–201.
- [7] Camargo AM, Voorwald HJ. Influence of anodization on fatigue strength of 7050-T7451 aluminium alloy. *Fatigue Fract Eng Mater Struct* 2007;30:993–1007.
- [8] Merati A, Eastaugh G. Determination of fatigue related discontinuity state of 7000 series of aerospace aluminium alloys. *Eng Fail Anal* 2007;14:673–85.
- [9] Monsalve A, Paez M, Toledano M, Artigas A, Valencia N. S–N–P curves in 7075-T7351 and 2024-T3 aluminium alloys subjected to surface treatments. *Fatigue Fract Eng Mater Struct* 2006;30:748–58.
- [10] Barter SA, Sharp PK, Clark G. Initiation and early growth of fatigue cracks in an aerospace aluminium alloy. *Fatigue Fract Eng Mater Struct* 2002;25:111–25.
- [11] Abramovici E, Leblanc P, Weaver B. The influence of etch pits on fatigue life of anodized aluminium alloys. In: International conference and exhibits on failure analysis. Canada; 1991. p. 21–32.
- [12] Shahzad M, Chaussumier M, Chieragatti R, Mabru C, Aria FR. Influence of surface treatments on fatigue life of Al 7010 alloy. *J Mater Process Technol* 2010;210:1821–6.
- [13] Military Specification MIL-H6088G. Heat treatment of aluminium alloys. USA: Department of Defense; 1991.
- [14] Peterson RE. Stress concentration factors. New York: Wiley; 1974.
- [15] Standard practice for conducting force controlled constant amplitude axial fatigue tests of metallic materials. ASTM E466; 2004.
- [16] Birbilis N, Buchheit RG. Electrochemical characteristics of intermetallic phases in aluminium alloys. *J Electrochem Soc* 2005;152:141–51.
- [17] Ezuber HA, Houd E, El-Shawesh F. A study on the corrosion behaviour of aluminium alloys in sea water. *Mater Des* 2008;29:801–5.
- [18] Savas TP, Earthman JC. Surface characterization of 7075-T73 aluminium exposed to anodizing pretreatment solutions. *J Mater Eng Perform* 2008;17:674–81.
- [19] Przystupa MA, Bucci RJ, Magnussen PE, Hinkle AJ. Microstructure based fatigue life predictions for thick plate 7050-T7451 airframe alloys. *Int J Fatigue* 1998;20:263–70.
- [20] Shiozawa K, Kbayashi H, Terada M, Matsui A. Effect of anodized films on fatigue strength in aluminium alloy. In: 5th International conference of computational and experimental methods; 2001. p. 397–406.