



**HAL**  
open science

## **Aethalometer multiple scattering correction Cref for mineral dust aerosols**

Claudia Di Biagio, Paola Formenti, Mathieu Cazaunau, Edouard Panguï,  
Nicolas Marchand, Jean-Francois Doussin

► **To cite this version:**

Claudia Di Biagio, Paola Formenti, Mathieu Cazaunau, Edouard Panguï, Nicolas Marchand, et al..  
Aethalometer multiple scattering correction Cref for mineral dust aerosols. Atmospheric Measurement  
Techniques, 2017, 10 (8), pp.2923-2939. 10.5194/amt-10-2923-2017 . hal-01656061

**HAL Id: hal-01656061**

**<https://hal.science/hal-01656061v1>**

Submitted on 17 Jan 2018

**HAL** is a multi-disciplinary open access archive for the deposit and dissemination of scientific research documents, whether they are published or not. The documents may come from teaching and research institutions in France or abroad, or from public or private research centers.

L'archive ouverte pluridisciplinaire **HAL**, est destinée au dépôt et à la diffusion de documents scientifiques de niveau recherche, publiés ou non, émanant des établissements d'enseignement et de recherche français ou étrangers, des laboratoires publics ou privés.



# Aethalometer multiple scattering correction $C_{\text{ref}}$ for mineral dust aerosols

Claudia Di Biagio<sup>1</sup>, Paola Formenti<sup>1</sup>, Mathieu Cazaunau<sup>1</sup>, Edouard Pangui<sup>1</sup>, Nicolas Marchand<sup>2</sup>, and Jean-François Doussin<sup>1</sup>

<sup>1</sup>Laboratoire Interuniversitaire des Systèmes Atmosphériques (LISA), UMR 7583, CNRS, Université Paris Est Créteil et Université Paris Diderot, Institut Pierre et Simon Laplace, Créteil, France

<sup>2</sup>Aix Marseille Univ., CNRS, LCE, Marseille, France

Correspondence to: Claudia Di Biagio (cldibiagio@gmail.com) and Paola Formenti (paola.formenti@lisa.u-pec.fr)

Received: 9 March 2017 – Discussion started: 18 April 2017

Revised: 11 July 2017 – Accepted: 12 July 2017 – Published: 15 August 2017

**Abstract.** In this study we provide a first estimate of the Aethalometer multiple scattering correction  $C_{\text{ref}}$  for mineral dust aerosols.  $C_{\text{ref}}$  is an empirical constant used to correct the aerosol absorption coefficient measurements for the multiple scattering artefact of the Aethalometer; i.e. the filter fibres on which aerosols are deposited scatter light and this is miscounted as absorption. The  $C_{\text{ref}}$  at 450 and 660 nm was obtained from the direct comparison of Aethalometer data (Magee Sci. AE31) with (i) the absorption coefficient calculated as the difference between the extinction and scattering coefficients measured by a Cavity Attenuated Phase Shift Extinction analyser (CAPS PMex) and a nephelometer respectively at 450 nm and (ii) the absorption coefficient from a MAAP (Multi-Angle Absorption Photometer) at 660 nm. Measurements were performed on seven dust aerosol samples generated in the laboratory by the mechanical shaking of natural parent soils issued from different source regions worldwide. The single scattering albedo (SSA) at 450 and 660 nm and the size distribution of the aerosols were also measured.

$C_{\text{ref}}$  for mineral dust varies between 1.81 and 2.56 for a SSA of 0.85–0.96 at 450 nm and between 1.75 and 2.28 for a SSA of 0.98–0.99 at 660 nm. The calculated mean for dust is 2.09 ( $\pm 0.22$ ) at 450 nm and 1.92 ( $\pm 0.17$ ) at 660 nm. With this new  $C_{\text{ref}}$  the dust absorption coefficient by the Aethalometer is about 2 % (450 nm) and 11 % (660 nm) higher than that obtained by using  $C_{\text{ref}} = 2.14$  at both 450 and 660 nm, as usually assumed in the literature. This difference induces a change of up to 3 % in the dust SSA at 660 nm. The  $C_{\text{ref}}$  seems to be independent of the fine and

coarse particle size fractions, and so the obtained  $C_{\text{ref}}$  can be applied to dust both close to sources and following transport. Additional experiments performed with pure kaolinite minerals and polluted ambient aerosols indicate  $C_{\text{ref}}$  of 2.49 ( $\pm 0.02$ ) and 2.32 ( $\pm 0.01$ ) at 450 and 660 nm (SSA = 0.96–0.97) for kaolinite, and  $C_{\text{ref}}$  of 2.32 ( $\pm 0.36$ ) at 450 nm and 2.32 ( $\pm 0.35$ ) at 660 nm for pollution aerosols (SSA = 0.62–0.87 at 450 nm and 0.42–0.76 at 660 nm).

## 1 Introduction

Mineral dust is abundant and widespread in the atmosphere and strongly contributes to the global and regional direct radiative effect and climate forcing (Highwood and Ryder, 2014; Miller et al., 2014). Mineral dust interacts through processes of scattering and absorption with both incoming shortwave radiation and outgoing terrestrial longwave radiation (Sokolik and Toon, 1999). Currently, the evaluation of the direct effect of mineral dust and its climate implications is still limited by knowledge of the intensity of dust absorption in the shortwave spectral range (Miller et al., 2004; Balkanski et al., 2007; Solmon et al., 2008; Jin et al., 2016), represented by the light absorption coefficient ( $\beta_{\text{abs}}$ , units of  $\text{Mm}^{-1}$ ). The absorption coefficient of mineral dust accounts for less than  $\sim 10$ – $20$  % of its total shortwave extinction, where it shows a pronounced spectral variation (Cattrall et al., 2003; Redmond et al., 2010). The highest dust absorption occurs in the UV-VIS region of the spectrum, while it levels off to null values towards the near IR (Caponi et al., 2017). As a result,

its single scattering albedo (SSA), i.e. the ratio of the aerosol scattering ( $\beta_{\text{sca}}$ ) to extinction ( $\beta_{\text{ext}} = \beta_{\text{sca}} + \beta_{\text{abs}}$ ) coefficient, increases from values of  $\sim 0.80$ – $0.90$  at 370 nm to values of  $\sim 0.95$ – $0.99$  at 950 nm (e.g. Schladitz et al., 2009; Redmond et al., 2010; Formenti et al., 2011; Ryder et al., 2013).

Given its relatively high SSA, mineral dust can be considered as weakly absorbing in the shortwave. This is particularly true when compared to other aerosol species, such as soot, for which the SSA in the visible may be as low as 0.2 (Bergstrom et al., 2007). Nonetheless, because of its elevated atmospheric concentration ( $\sim 100$ – $100\,000\ \mu\text{g m}^{-3}$  close to sources and  $\sim 0.1$ – $100\ \mu\text{g m}^{-3}$  after mid- to inter-continental transport; e.g. Goudie and Middleton, 2006; Kandler et al., 2009; Querol et al., 2009; Denjean et al., 2016a), light absorption by mineral dust can be comparable to that of soot both at regional and global scales (Reddy et al., 2005; Caponi et al., 2017). Under very intense dust episodes, dust may absorb up to  $\sim 150\ \text{W m}^{-2}$  of incoming solar radiation (Slingo et al., 2006; di Sarra et al., 2011), inducing a remarkable warming of the atmospheric layer. This strong warming can alter the atmospheric structure and stability (Heinold et al., 2008), with a possible influence on the atmospheric dynamics and meteorological fields (Pérez et al., 2006). By its direct shortwave effect, dust also affects the position of the Intertropical Convergence Zone, which in turn influences the West African Monsoon and modifies the pattern and intensity of rainfall over northern Africa and the Sahel (Yoshioka et al., 2007). Nonetheless, the extent of the dust effect and its implications critically depend on the exact amount of absorbed shortwave radiation. Solmon et al. (2008), for example, showed that a small change (5%) in the shortwave SSA of dust may modify the effect of dust on the West African Monsoon, moving from a reduction to an increase of precipitation over the Sahel.

The accurate estimation of the dust absorption over the whole shortwave range is therefore necessary to properly assess its direct radiative effect and climate implications. One instrument used to obtain aerosol–light absorption from the UV to near-IR range is the Aethalometer (Magee Sci. AE31 model, Hansen et al., 1984; Arnott et al., 2005), operating at seven wavelengths in the 370–950 nm range. The Aethalometer reports equivalent black carbon mass concentration but the spectral absorption by aerosols can be also calculated. Given its large spectral interval, the Aethalometer has been used in the past to investigate the spectral dependence of dust absorption (Fialho et al., 2005; Formenti et al., 2011), as well as the absorption by many aerosol types in different environments (Sandradewi et al., 2008; Segura et al., 2014; Di Biagio et al., 2016; Backman et al., 2016). General reviews on aerosol absorption measurements and their applications are provided by Horvath (1993) and Moosmüller et al. (2009).

The working principle of the Aethalometer, a filter-based instrument, consists of measuring the attenuation through an aerosol-laden quartz filter according to the Beer–Lambert

law, used then to derive the spectral attenuation coefficient ( $\beta_{\text{ATT}}$ ) of the deposited particles (Hansen et al., 1984). The “true” spectral aerosol absorption coefficient ( $\beta_{\text{abs}}$ ) is proportional but lower than  $\beta_{\text{ATT}}$  (Weingartner et al., 2003; Colaud Coen et al., 2010; hereinafter referred to as W2003 and C2010), because  $\beta_{\text{ATT}}$  is enhanced by (i) aerosol scattering towards directions different from that of the detector (scattering effect); (ii) gradual accumulation of absorbing particles on the loaded filter, thus reducing the optical path (loading effect); (iii) multiple scattering of the light beam by the filter fibres, increasing the optical path (multiple scattering effect).

Empirical formulations of the scattering and loading effects are available in the literature and permit the correction of Aethalometer data for these artefacts (W2003; Arnott et al., 2005; Schmid et al., 2006; Virkkula et al., 2007; C2010). The correction of the multiple scattering effect instead requires the knowledge of a correction factor  $C_{\text{ref}}$ , which needs to be directly estimated by comparison of Aethalometer data against reference absorption measurements (W2003; C2010).

Currently data for  $C_{\text{ref}}$  are available for soot particles ( $C_{\text{ref}} = 2.1$ – $2.2$  at 660 nm, W2003), internally and externally mixed soot particles and organic material ( $C_{\text{ref}} = 2.3$ – $3.9$ , W2003), and ambient aerosols collected in Europe and Amazonia ( $C_{\text{ref}} = 2.6$ – $4.8$ , C2010;  $C_{\text{ref}} = 4.9$ – $6.3$ , Saturno et al., 2016) and in the Arctic ( $C_{\text{ref}} = 3.1$ , Backman et al., 2016). The value most often used in the literature is 2.14 ( $\pm 0.21$ ), assumed as wavelength-independent (e.g. Sandradewi et al., 2008; Formenti et al., 2011; Di Biagio et al., 2016), which corresponds to the mean of observations at 660 nm for soot aerosols (W2003). Both W2003 and C2010, however, found a dependence of  $C_{\text{ref}}$  on the aerosol single scattering albedo, with  $C_{\text{ref}}$  decreasing for increasing SSA. Thus, the value of 2.14 obtained for highly absorbing soot (SSA  $\sim 0.2$  in the visible) may not be appropriate for weakly absorbing mineral dust.

Henceforth, in this work we present the experimental estimate of  $C_{\text{ref}}$  for mineral dust aerosols at 450 and 660 nm obtained from a laboratory-based intercomparison study. Experiments were conducted on seven dust aerosol samples generated by the mechanical shaking of natural parent soils. Control experiments on pure kaolinite mineral, ambient aerosols sampled in the polluted environment of the suburbs of Paris, and purely scattering ammonium sulfate were also performed to investigate the dependence of  $C_{\text{ref}}$  on the aerosol single scattering albedo.

## 2 Experimental set-up

The experimental set-up used for the intercomparison study is shown in Fig. 1. Instrumental details and uncertainties are summarized in Table 1. The following measurements were performed from a 8-port glass manifold ( $\sim 1\ \text{L}$  volume):

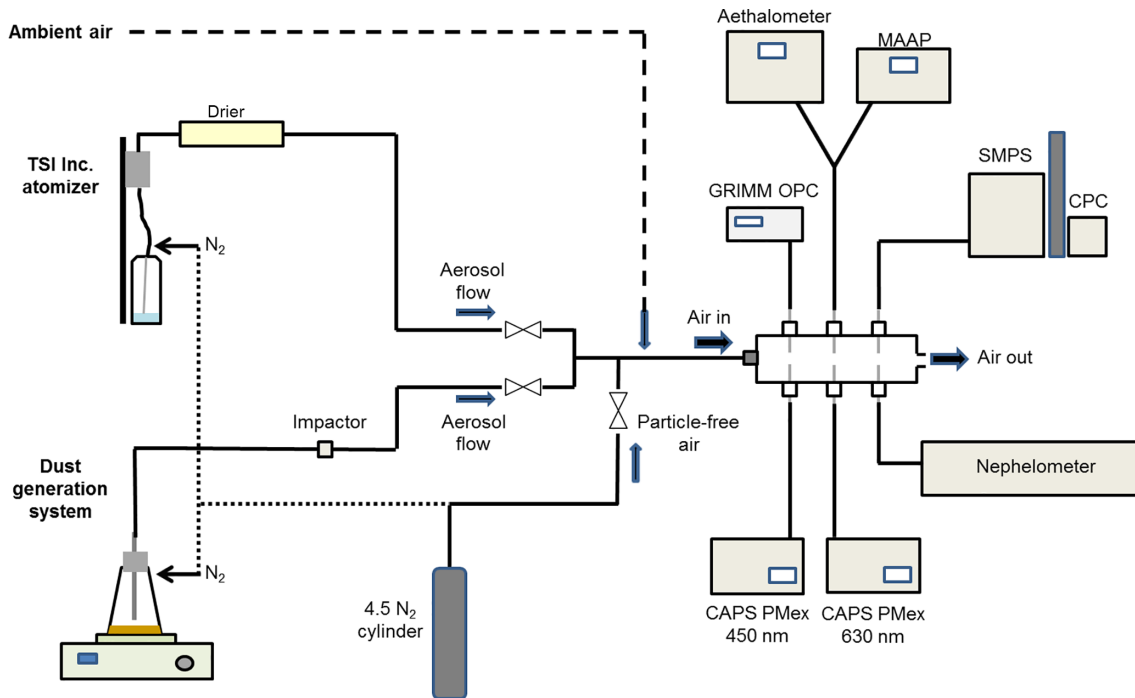

**Figure 1.** Experimental set-up used for the Aethalometer intercomparison experiments.

**Table 1.** Specifications and references of instruments used during experiments.

Instrument	Property	Operating wavelength (nm)	Time resolution	Flow rate ( $L\ min^{-1}$ )	Percent uncertainty	Reference
Aethalometer (model AE-31, Magee Sci.)	Spectral absorption coefficient	370, 470, 520, 590, 660, 880, 950	2 min	8	$\pm 20\%$ (attenuation coefficient)	Hansen et al. (1984); W2003; C2010
Multi-Angle Absorption Photometer (MAAP, model 5012, Thermo Sci.)	Single-wavelength absorption coefficient	670	1 min	8	$\pm 12\%$	Petzold and Schönlinner (2004); Petzold et al. (2005)
Cavity Attenuated Phase Shift Extinction (CAPS PMex, Aerodyne)	Spectral extinction coefficient	450, 630	1 s	0.85	$\pm 5\%$	Massoli et al. (2010)
Nephelometer (model 3563, TSI Inc.)	Spectral scattering coefficient	450, 550, 700	1 s	18	$\pm \sim 9\%$	Sherman et al. (2015)
SMPS (DMA model 3080, CPC model 3772, TSI Inc.)	Number size distribution	–	3 min	2	–	De Carlo et al. (2004)
OPC optical particle counter (model 1.109, Grimm Inc.)	Number size distribution	655	6 s	1.2	$\pm 15\%$ (diameter optical to geometric conversion); $\pm 10$ (concentration)	Heim et al. (2008)

– The absorption coefficient ( $\beta_{abs}$ ) was measured by a 7-wavelength Aethalometer (Magee Sci., model AE31 working at 370, 470, 520, 590, 660, 880, 950 nm; flow rate  $8\ L\ min^{-1}$ , 2 min resolution) and a MAAP (Multi-Angle Absorption Photometer, Thermo Sci., model

5012 working at 670 nm; flow rate  $8\ L\ min^{-1}$ , 1 min resolution). Unlike the Aethalometer, the MAAP measures the transmitted light from the aerosol-laden filter as well as the backscattered light at two angles ( $135^\circ$  and  $165^\circ$ ) (Petzold et al., 2005). Backscattering mea-

surements are used to constrain the scattering fraction of the measured attenuation that would erroneously be interpreted as absorption. The aerosol absorption coefficient for the MAAP is obtained from a radiative transfer scheme, taking into account the multiple scattering in the filter and the scattering effect, without requiring any further adjustment (Petzold and Schönlinner, 2004). The MAAP is commonly assumed to provide the most reliable filter-based direct estimate of the aerosol absorption coefficient at a single wavelength (Andreae and Gelencser, 2006). In this study we assume for the MAAP the manufacturer's reported wavelength of 670 nm, although Müller et al. (2011) measured a wavelength of 637 nm for this instrument. An estimate of the change in the obtained  $C_{\text{ref}}$  due to the change in MAAP nominal wavelength from 670 to 637 nm is reported in Sect. 4.2.

- The scattering coefficient ( $\beta_{\text{sca}}$ ) was measured by a 3-wavelength nephelometer (TSI Inc., model 3563 working at 450, 550 and 700 nm; flow rate 18 L min<sup>-1</sup>, 1 s resolution).
- The extinction coefficient ( $\beta_{\text{ext}}$ ) was measured by two Cavity Attenuated Phase Shift Extinction analysers (CAPS PMex by Aerodyne; one working at 450 nm and the other at 630 nm; flow rate 0.85 L min<sup>-1</sup>, 1 s resolution).
- The particle number size distribution ( $dN/d\log D$ ) was measured by a scanning mobility particle sizer, SMPS (TSI Inc., DMA Model 3080, CPC Model 3772; operated at 2.0/0.2 L min<sup>-1</sup> sheath/aerosol flow rates; 3 min resolution) and an optical particle counter, OPC (Grimm Inc., model 1.109, 655 nm operating wavelength; flow rate 1.2 L min<sup>-1</sup>, 6 s resolution). The SMPS measures the aerosol number concentration in the electrical mobility diameter ( $D_{\text{m}}$ ) range 0.019–0.882  $\mu\text{m}$ , and the OPC measures in the optical equivalent diameter ( $D_{\text{opt}}$ ) range 0.25–32  $\mu\text{m}$ .

Sampling lines from the manifold to the instruments were made of conductive silicone tubing (TSI Inc.,  $6.4 \times 10^{-3}$  m diameter) to minimize particle loss by electrostatic deposition. They were designed to be as straight and as short as possible. Their length, varying between 0.3 and 0.7 m, was adjusted based on the flow rate of each instrument to ensure an equivalent particle loss, so that the same aerosol size distribution was input to the different instruments. Particular care was given to ensure the same aerosol size at the input of the Aethalometer and the MAAP. To this end, as illustrated in Fig. 1, the two instruments sampled air from the same manifold exit line, and the same sampling flow rate was also set for the two instruments (8 L min<sup>-1</sup>). Particle loss calculations were performed with Particle Loss Calculator (PLC) software (von der Weiden et al., 2009).

Aerosols were generated in three ways:

- Mineral dust was generated by mechanical shaking as described and validated in Di Biagio et al. (2014, 2017). About 3 g of soil sample (sieved at 1000  $\mu\text{m}$  and dried at 100 °C) was placed in a Büchner flask and shaken at 100 Hz by a sieve shaker (Retsch AS200). The dust was injected in the manifold by a flow of N<sub>2</sub> at 3.5 L min<sup>-1</sup> through a single-stage impactor used to eliminate particles larger than about 20  $\mu\text{m}$ , which could be preferentially sampled by the instruments with the highest flow rate. Pure N<sub>2</sub> was added to the aerosol flow to make the injection flow equal to the total sampling flow by instruments connected to the manifold (about 38 L min<sup>-1</sup>).
- Ammonium sulfate (Sigma-Aldrich 99.999 % purity, 0.03 M solution in ultrapure water) and kaolinite particles (Source Clay Repository KGa-2, 0.05 M solution in ultrapure water) were generated by a constant flow atomizer (TSI, model 3075) operated at 3 L min<sup>-1</sup> and coupled with a diffusion drier (TSI, model 3062). As for dust, pure N<sub>2</sub> was added to the aerosol flow to equalize the total sampling flow.
- Ambient pollution aerosols were sampled by opening the manifold to the exterior ambient air. Ambient aerosols were not dried before entering the manifold. Sampling was performed at the University Paris-Est Creteil, in the suburbs of Paris, at the ground floor of the University building, which is close to a main local road ( $\sim 20$  m) and to the A86 highway ( $\sim 200$  m).

### 3 Strategy for data analysis

The Aethalometer spectral attenuation coefficient  $\beta_{\text{ATT}}(\lambda)$  is related to the measured attenuation  $\text{ATT}(\lambda)$  through the following formula:

$$\beta_{\text{ATT}}(\lambda) = \frac{\Delta \text{ATT}(\lambda)}{\Delta t} \frac{A}{V}, \quad (1)$$

where  $A$  is the area of the aerosol collection spot ( $0.5 \pm 0.1$ ) cm<sup>2</sup> and  $V$  the air sample volume (0.016 m<sup>3</sup> over 2 min integration time).  $\Delta \text{ATT}(\lambda)/\Delta t$  in Eq. (1) can be calculated as the linear fit of the measured attenuation as a function of time.

The spectral attenuation coefficient  $\beta_{\text{ATT}}(\lambda)$  measured by the Aethalometer is related to the targeted absorption coefficient  $\beta_{\text{abs}}(\lambda)$  using the following formula (C2010):

$$\beta_{\text{abs}}(\lambda) = \frac{\beta_{\text{ATT}}(\lambda) - \alpha(\lambda)\beta_{\text{sca}}(\lambda)}{R \cdot C_{\text{ref}}}, \quad (2)$$

where the different terms parameterize different instrument artefacts:

- the scattering effect  $\alpha(\lambda)\beta_{\text{sca}}(\lambda)$ , that is, the amount of scattered radiation by the aerosols deposited on the filter that is miscounted as absorption, where  $\alpha(\lambda)$  is

a wavelength-dependent proportionality constant and  $\beta_{\text{sca}}(\lambda)$  is the aerosol spectral scattering coefficient;

- the loading effect  $R$ , representing the artificial flattening of measured attenuation with time due to the gradual accumulation of absorbing particles on the loaded filter;
- the multiple scattering  $C_{\text{ref}}$ , representing multiple scattering of the light beam by the filter fibres.

The  $\alpha(\lambda)$  term and  $R$  in Eq. (2) can be calculated through various empirical formulas reported in the literature (W2003, Arnott et al., 2005; Virkkula et al., 2007; Schmid et al., 2006; C2010). The determination of  $C_{\text{ref}}$ , instead, is the objective of our study.

### 3.1 Scattering effect correction

Arnott et al. (2005) provide for  $\alpha(\lambda)$  the following formulation:

$$\alpha(\lambda) = A^{d-1} \cdot c \cdot \lambda^{-\alpha_S(d-1)}, \quad (3)$$

where the  $A$  and  $\alpha_S$  terms are obtained from the power-law fit of  $\beta_{\text{sca}}(\lambda)$  versus  $\lambda$ , and the  $c$  and  $d$  terms can be determined from the power-law fit of the attenuation  $\beta_{\text{ATT}}(\lambda)$  versus the scattering  $\beta_{\text{sca}}(\lambda)$  coefficient as

$$\beta_{\text{sca}}(\lambda) = A\lambda^{-\alpha_S} \quad (4)$$

$$\beta_{\text{ATT}}(\lambda) = c\beta_{\text{sca}}(\lambda)^d. \quad (5)$$

### 3.2 Loading effect correction

Two formulations for the loading effect correction  $R$  are proposed by W2003 and C2010:

$$R(\text{W2003})(\lambda) = \left( \frac{1}{f(\lambda)} - 1 \right) \frac{\ln(\text{ATT}(\lambda)) - \ln(10\%)}{\ln(50\%) - \ln(10\%)} + 1 \quad (6a)$$

$$R(\text{C2010})(\lambda) = \left( \frac{1}{f(\lambda)} - 1 \right) \frac{\text{ATT}(\lambda)}{50\%} + 1. \quad (6b)$$

The factor  $f(\lambda)$  represents the dependence of the loading effect on the aerosol absorption. This dependence is parameterized by the aerosol single scattering albedo  $\text{SSA}(\lambda)$  in the form of

$$f(\lambda) = a(1 - \text{SSA}(\lambda)) + 1, \quad (7)$$

where  $a$ , equal to 0.85 in W2003 and 0.74 in C2010, is obtained as the slope of the linear fit between the attenuation coefficient  $\beta_{\text{ATT}}$  normalized to its value at 10% attenuation ( $\beta_{\text{ATT}}/\beta_{10\%}$ ) and the natural logarithm of the measured attenuation  $\ln(\text{ATT}(\lambda))$ .

### 3.3 Multiple scattering correction

For the determination of  $C_{\text{ref}}$  only  $\beta_{\text{ATT}}$  and  $R$  are required. Hence, in this work, attenuation data from the Aethalometer were corrected for the loading effect  $R$  but not for the scattering term  $\alpha(\lambda)\beta_{\text{sca}}(\lambda)$ . Three different formulations of  $C_{\text{ref}}$  were therefore considered:

$$C_{\text{ref}}^*(\lambda) = \frac{\beta_{\text{ATT}}(\lambda)}{\beta_{\text{abs-ref}}(\lambda)} \quad (8a)$$

$$C_{\text{ref}}(\text{W2003})(\lambda) = \frac{1}{\beta_{\text{abs-ref}}(\lambda)} \frac{\beta_{\text{ATT}}(\lambda)}{R(\text{W2003})(\lambda)} \quad (8b)$$

$$C_{\text{ref}}(\text{C2010})(\lambda) = \frac{1}{\beta_{\text{abs-ref}}(\lambda)} \frac{\beta_{\text{ATT}}(\lambda)}{R(\text{C2010})(\lambda)}. \quad (8c)$$

The  $\beta_{\text{abs-ref}}$  term in Eqs. (8a–c) represents the reference absorption coefficient estimated from independent measurements.  $C_{\text{ref}}^*$  does not take into account the loading effect correction in Aethalometer data, as in Schmid et al. (2006).  $C_{\text{ref}}(\text{W2003})$  and  $C_{\text{ref}}(\text{C2010})$  take this correction into account by using the  $R(\text{W2003})$  and the  $R(\text{C2010})$  parameterizations, respectively. The spectral  $\beta_{\text{ATT}}/R(\text{C2010})$  was used to calculate the absorption Ångström exponent ( $\alpha_A$ ). Note that in this work we considered, for each experiment, only data corresponding to  $\text{ATT} < 20\%$  to calculate  $\beta_{\text{ATT}}$  ( $R^2 > 0.99$  for the  $\Delta\text{ATT}/\Delta t$  fits in all cases; see Eq. 1). This threshold was fixed based on two requirements: first, we limited our data analysis to points with low attenuation in order to account almost exclusively for the scattering by the filter fibres in the  $C_{\text{ref}}$  calculation and not for the scattering from aerosol particles embedded in the filter. This choice was also made for consistency with the literature, since both W2003 and C2010 relate  $C_{\text{ref}}$  to  $\text{ATT} \sim 10\%$ . Second, this choice ensured that enough data points were available for analysis regardless of the aerosol type, in particular for ambient aerosols, for which attenuation rapidly exceeded 10%.

### 3.4 Determination of reference absorption coefficient and single scattering albedo

The reference absorption coefficient  $\beta_{\text{abs-ref}}$  in Eqs. (8a–c) was obtained in different ways depending on wavelength. At 450 nm,  $\beta_{\text{abs-ref}}$  was obtained with the “extinction minus scattering” approach by using the CAPS measurements for extinction and the nephelometer measurements for scattering. At 660 nm,  $\beta_{\text{abs-ref}}$  was extrapolated from MAAP measurements at 670 nm.

#### 3.4.1 Direct determination of reference absorption coefficient at 660 nm from the MAAP

The reference absorption coefficient  $\beta_{\text{abs-ref}}$  at 660 nm was obtained by the MAAP measurement at 670 nm. The MAAP attenuation (ATT) at 670 nm is estimated from the measured transmission (T) and retrieved single scattering albedo of the

aerosol-filter layer ( $\text{SSA}_0$ , from the inversion algorithm) as

$$\text{ATT}(670) = (1 - \text{SSA}_0) \cdot \ln T \cdot 100. \quad (9)$$

Equation (1) is applied to estimate the absorption coefficient at 670 nm from  $\text{ATT}(670)$ . The area of the aerosol collection spot is 2 cm<sup>2</sup> and the sampled volume is 0.008 m<sup>3</sup> over 1 min integration time. The absorption coefficient of the MAAP was extrapolated to the 660 nm wavelength by using the absorption Ångström exponent  $\alpha_A$  calculated from Aethalometer data.

### 3.4.2 Indirect determination of reference absorption coefficient at 450 nm: extinction minus scattering approach

The reference absorption coefficient  $\beta_{\text{abs-ref}}$  at 450 nm was calculated as the difference between the extinction and scattering coefficient from the CAPS and the nephelometer.

The extinction coefficient  $\beta_{\text{ext}}$  at 450 and 630 nm was measured directly by the two CAPS analysers without additional corrections (Massoli et al., 2010). The spectral  $\beta_{\text{ext}}$  was used to calculate the extinction Ångström exponent ( $\alpha_E$ ), which was then applied to extrapolate  $\beta_{\text{ext}}$  at 660 nm.

The scattering coefficient  $\beta_{\text{sca}}$  at 450, 550, and 700 nm measured by the nephelometer between 7 and 170° was corrected for the size-dependent angular truncation of the sensing volume to report it to the full angular range 0–180° (Anderson and Ogren, 1998). Two different approaches were used: for submicrometric ammonium sulfate, the correction proposed by Anderson and Ogren (1998) was applied, while for aerosols with a significant coarse fraction (dust, ambient air and kaolinite), the truncation correction was estimated by optical calculations according to the Mie theory for homogeneous spherical particles using the measured number size distribution as input. In the calculations the real and the imaginary parts of the complex refractive index  $m$  ( $m = n - ik$ , where  $n$  is the real part and  $k$  is the imaginary part) were varied in the wide range 1.42–1.56 and 0.001–0.025*i* for dust (Di Biagio et al., 2017), and 1.50–1.72 and 0.001–0.1*i* for ambient air (Di Biagio et al., 2016), while the value of 1.56–0.001*i* was assumed for kaolinite (Egan and Hilgeman, 1979; Utry et al., 2015). Then,  $n$  and  $k$  were set to the values which reproduced the measured  $\beta_{\text{sca}}$  at 7–170°. The truncation correction factor ( $C_{\text{trunc}}$ ) was estimated as the ratio of the modelled  $\beta_{\text{sca}}$  at 0–180 and 7–170°. At the three nephelometer wavelengths (450, 550, and 700 nm) the correction factor  $C_{\text{trunc}}$  varied in the range 1.03–1.06 for ammonium sulfate, 1.08–1.6 for dust, 1.03–1.05 for kaolinite, and 1.05–1.25 for ambient air. For both approaches (Anderson and Ogren, 1998 correction and Mie calculations) the uncertainty on the truncation correction was estimated to be less than 3%. Once corrected for truncation, the spectral  $\beta_{\text{sca}}$  was used to calculate the scattering Ångström exponent ( $\alpha_S$ ), which was then applied to extrapolate  $\beta_{\text{sca}}$  at 630 and 660 nm.

### 3.4.3 Determination of the single scattering albedo (SSA)

The aerosol single scattering albedo (SSA) represents the ratio of scattering to extinction. At 450 nm, the SSA was estimated by nephelometer and CAPS data (Eq. 10), while at 660 nm CAPS data were combined with MAAP observations (Eq. 11):

$$\text{SSA}(450) = \frac{\beta_{\text{sca}}(450)_{\text{nephelometer}}}{\beta_{\text{ext}}(450)_{\text{CAPS}}} \quad (10)$$

$$\text{SSA}(660) = \frac{\beta_{\text{ext}}(660)_{\text{CAPS}} - \beta_{\text{abs-MAAP}}(660)}{\beta_{\text{ext}}(660)_{\text{CAPS}}}. \quad (11)$$

### 3.5 Number size distribution and effective fine and coarse diameter

The number size distribution was measured by a combination of SMPS and OPC observations. For the SMPS, corrections for particle loss by diffusion in the instrument tubing and the contribution of multiple-charged particles were performed using the SMPS software. The electrical mobility diameter measured by the SMPS can be converted to a geometrical diameter ( $D_g$ ) by taking into account the particle dynamic shape factor ( $\chi$ ;  $D_g = D_m/\chi$ ). In this study, the SMPS showed good agreement with OPC data for a shape factor  $\chi = 1$ , which corresponds to spherical particles.

The OPC optical-equivalent nominal diameters were converted into sphere-equivalent geometrical diameters ( $D_g$ ) by taking into account the aerosol complex refractive index. This consisted of recalculating the OPC calibration curve for different complex refractive index values. For dust aerosols the refractive index was varied in the range 1.47–1.53 ( $n$ ) and 0.001–0.005*i* ( $k$ ) following the literature (see Di Biagio et al., 2017) and  $D_g$  was set at the mean  $\pm$  one standard deviation of the values obtained for the different  $n$  and  $k$ . For kaolinite the OPC diameter conversion was performed by setting the refractive index at 1.56–0.001*i*. For ambient air the refractive index was set at 1.60–0.01*i*, a value that represents a medium absorbing urban polluted aerosol (see Di Biagio et al., 2016). The impact of humidity on the refractive index of ambient aerosols and associated changes OPC response were not taken into account. The relative humidity was always below 35% during ambient air measurements, which implies a very small particle growth. After conversion, the OPC diameter range became 0.28–18.0  $\mu\text{m}$  for dust (taking into account the particle cut at  $\sim 20 \mu\text{m}$  due to the use of the impactor), and 0.27–58.0  $\mu\text{m}$  for kaolinite and 0.28–65.1  $\mu\text{m}$  for ambient air (the impactor was not used in these cases). The uncertainty was < 15% at all diameters.

The aerosol effective fine ( $D_{\text{eff,fine}}$ ) and coarse ( $D_{\text{eff,coarse}}$ ) diameter were estimated from OPC data as

$$D_{\text{eff}} = \frac{\int_{D_1}^{D_2} D_g^3 \frac{dN}{d \log D_g} d \log D_g}{\int_{D_1}^{D_2} D_g^2 \frac{dN}{d \log D_g} d \log D_g}, \quad (12)$$

with  $D_1 = 0.3 \mu\text{m}$  and  $D_2 = 1 \mu\text{m}$  for the fine mode and  $D_1 = 1 \mu\text{m}$  and  $D_2 = 10 \mu\text{m}$  for the coarse mode.

### 3.6 Data integration and error analysis

Aethalometer data were first processed at 2 min resolution to obtain the time evolution of the attenuation coefficients  $\beta_{\text{ATT}}$  and  $\beta_{\text{ATT}}/R$ . Data from the MAAP, CAPS, nephelometer, OPC and SMPS were averaged over 2 min, so they could be reported as having the same resolution as the Aethalometer.

The  $\beta_{\text{ATT}}$  and  $\beta_{\text{ATT}}/R$  were calculated over the whole duration of each experiment from Eqs. (1) and (6). Corresponding averages of the reference absorption coefficient ( $\beta_{\text{abs-ref}}$ ) were calculated for each experiment and used to estimate  $C_{\text{ref}}$ . Experiment averages of SSA,  $D_{\text{eff, fine}}$ , and  $D_{\text{eff, coarse}}$  were also calculated to be related to the obtained  $C_{\text{ref}}$ .

The uncertainty of  $C_{\text{ref}}$  was estimated with the error propagation formula by taking into account the uncertainties on  $\beta_{\text{ATT}}$ ,  $\beta_{\text{ATT}}/R$ , and the standard deviation of the averaged  $\beta_{\text{abs-ref}}$  from the CAPS-nephelometer and the MAAP. The uncertainty of  $\beta_{\text{ATT}}$  was estimated as the quadratic combination of the uncertainty of the linear fit of  $\Delta\text{ATT}$  with respect to time and the uncertainties on the surface deposit  $A$ . The uncertainty of  $\beta_{\text{ATT}}/R$  was estimated by taking into account the uncertainty of  $\beta_{\text{ATT}}$  and  $R$ . Uncertainties on  $\beta_{\text{ATT}}$  and  $\beta_{\text{ATT}}/R$  are both  $\sim 20\%$ .

## 4 Results

The time series of observations for all the experiments are shown in Fig. 2 as 2 min averages. Seven experiments were performed on mineral dust issued from six different areas in the Sahel (Niger), eastern Asia (China), North America (Arizona), northern Africa (Tunisia), Australia, and southern Africa (Namibia), and on a kaolinite powder. Experiments were performed between the 3 and the 9 November 2016 and lasted between 1 and 2 h each. The experiments on Niger dust (labelled as Niger 1 and Niger 2) were duplicated to test the repeatability of the obtained  $C_{\text{ref}}$ . Ambient air data were collected between the 8 and the 14 November 2016 for a total of 7 h of measurements. Eight different periods characterized by little variation and different levels of SSA were selected in the whole set of ambient air measurements. These are identified as ambient air 1 to 8. The summary of information is provided in Table 2. SMPS data were available for ammonium sulfate and kaolinite experiments, for one of the two Niger dust experiments (Niger 2), and for some of the ambient air experiments. OPC measurements were performed for all experiments with the exception of the ammonium sulfate.

### 4.1 Quality control data

Results of the ammonium sulfate control experiment (24 October 2016) used to test the performance of the optical instruments are illustrated in Fig. 3. As expected for this purely

scattering aerosol (Toon et al., 1976), the nephelometer scattering and the CAPS extinction at 450 and 630 nm were in very good agreement (less than 4 % difference) during the whole duration of the experiment. This is well below the single instrument uncertainty of  $\pm 9\%$  for the nephelometer (Sherman et al., 2015) and  $\pm 5\%$  for the CAPS (Massoli et al., 2010). This is further demonstrated by the scatter plot of their respective 10 min averages, yielding a linear regression in the form of  $y = 0.95x + 5.1$  ( $R^2 = 0.95$ ) at 450 nm and  $y = 1.01x - 1.4$  ( $R^2 = 0.98$ ) at 630 nm. The average  $\beta_{\text{ext}}$  at 450 and 630 nm from CAPS observations were  $913 (\pm 52)$  and  $424 (\pm 33) \text{Mm}^{-1}$ , respectively, while the average  $\beta_{\text{sca}}$  was  $921 (\pm 36)$  and  $420 (\pm 17)$ . This led to an average SSA of  $1.01 (\pm 0.07)$  at 450 nm and  $0.99 (\pm 0.07)$  at 630 nm.

The absorption coefficient, averaged over the duration of the experiment, was  $0.10 (\pm 0.04) \text{Mm}^{-1}$  at 450 nm and  $0.24 (\pm 0.07) \text{Mm}^{-1}$  at 660 nm according to the Aethalometer, and  $0.82 (\pm 0.13) \text{Mm}^{-1}$  at 660 nm according to the MAAP. For the Aethalometer, the absorption coefficient was calculated from Eq. (2) assuming  $C_{\text{ref}} = 2.14$  and the  $R$  formulation by C2010 (Eq. 6b). The  $\alpha(\lambda)$  coefficient was calculated from Eq. (3). The  $c$  and  $d$  terms in Eq. (3) were determined from the power-law fit of  $\beta_{\text{ATT}}(\lambda)$  vs.  $\beta_{\text{sca}}(\lambda)$  and are  $c = (0.56 \pm 0.06) \text{Mm}^{-1}$  and  $d = (0.485 \pm 0.09)$ . These values are lower than those reported by Arnott et al. (2005) ( $c = 0.797$ ,  $d = 0.564$ ). The  $A$  and  $\alpha_S$  terms, obtained from the power-law fit of  $\beta_{\text{sca}}(\lambda)$  vs. wavelength (Eq. 3) are  $A = (4.07 \pm 0.49) \times 10^9 \text{Mm}^{-1}$  and  $\alpha_S = (-2.46 \pm 0.12)$ .

Figure 4 shows the extinction coefficient at 660 nm extrapolated from CAPS observations and calculated as the sum of nephelometer and MAAP data for dust, kaolinite, and ambient air experiments. The linear regression of the data yields  $y = 1.03x - 0.5$  ( $R^2 = 0.99$ ), indicating the consistency of optical measurements between the CAPS, nephelometer, and MAAP (less than 3 % difference on average). Based on the success of the optical closure at 660 nm, we therefore assume the ‘‘CAPS minus nephelometer’’ approach, which is appropriate for estimating the aerosol absorption coefficient at 450 nm.

### 4.2 Estimate of $C_{\text{ref}}$

The  $C_{\text{ref}}^*$ ,  $C_{\text{ref}}(\text{W2003})$  and  $C_{\text{ref}}(\text{C2010})$  at 450 and 660 nm obtained for all different experiments and the corresponding aerosol SSA,  $D_{\text{eff, fine}}$ , and  $D_{\text{eff, coarse}}$  are summarized in Table 2.

$C_{\text{ref}}$  for mineral dust varied between 1.81 and 2.56 for a SSA of 0.85–0.96 at 450 nm and between 1.75 and 2.28 for a SSA of 0.98–0.99 at 660 nm. The estimate for Niger 1 and 2 samples agreed within 4.9 %, which suggests a good repeatability of the  $C_{\text{ref}}$  estimate. For kaolinite  $C_{\text{ref}}$  was 2.47–2.51 and 2.31–2.34 at 450 and 660 nm, respectively, with an associated SSA of 0.96 and 0.97 at the two wavelengths. For ambient air  $C_{\text{ref}}$  varied in the range 1.91–4.35 for a SSA of 0.62–0.87 at 450 nm and 1.66–2.96 for and SSA of 0.42–0.76



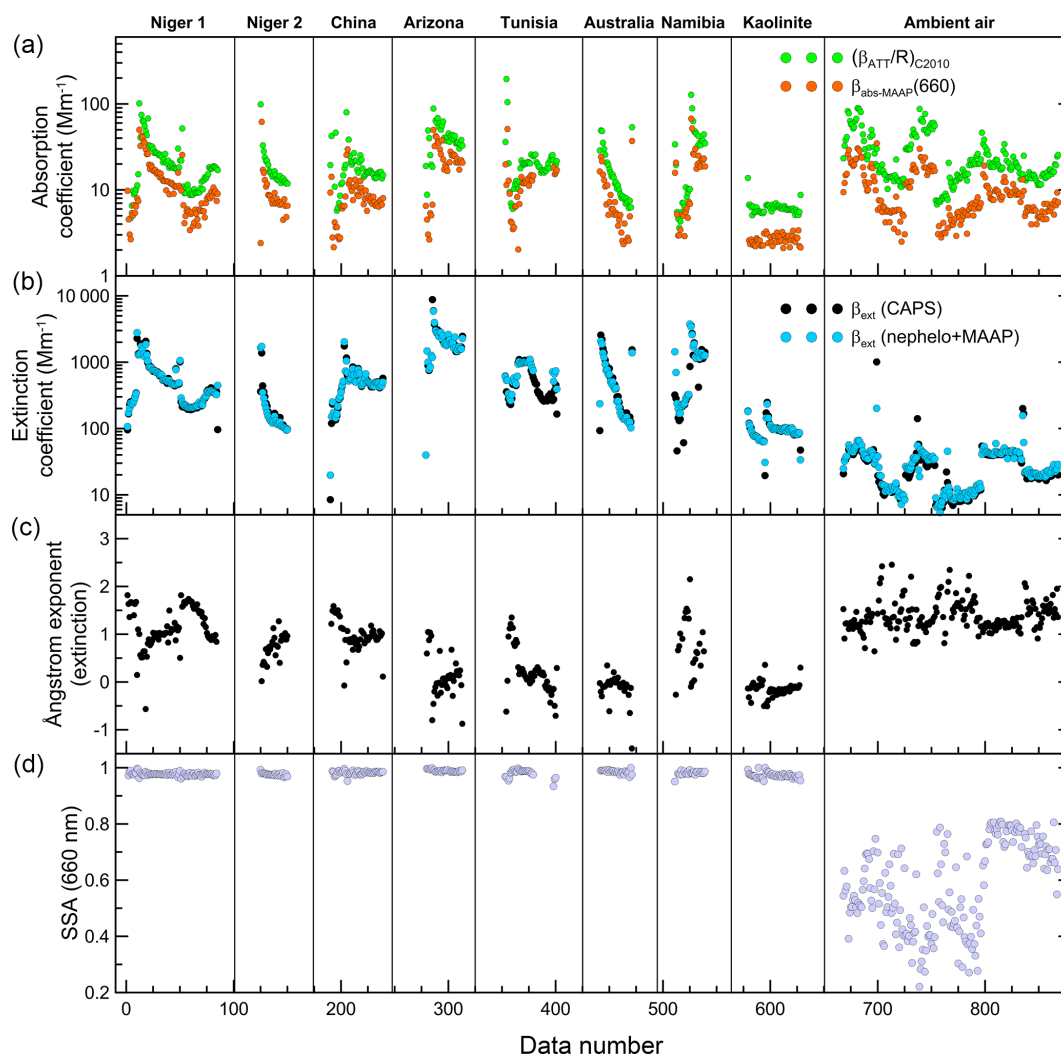

**Figure 2.** Temporal series of experiments showing the measured optical data at 660 nm. The different panels show (from the top to the bottom): (a) the loading-corrected Aethalometer attenuation at 660 nm (data corrected with the  $R$  formulation by Collaud Coen et al. (2010) (referred to as  $R(\text{C2010})$ ) are shown) and the MAAP aerosol absorption coefficient; (b) the aerosol extinction at 660 nm extrapolated from CAPS PMex measurements and estimated as the sum of nephelometer scattering and MAAP absorption; (c) the extinction aerosol Ångström exponent; (d) the aerosol single scattering albedo at 660 nm. Each point in the plot corresponds to 2 min average data. The  $x$  axis indicates the data point sequential number. Experiments with dust samples and kaolinite occurred between the 3 and the 9 November 2016 and lasted between 1 and 2 h each. Ambient air data were collected at different steps between the 8 and the 14 November 2016 for a total of 7 h of measurements.

at 660 nm. For samples 6 and 8 the  $C_{\text{ref}}$  at 450 was lower than at 660 nm. Otherwise, for all other cases, the  $C_{\text{ref}}$  was larger at 450 nm than at 660 nm.

Differences within 2.8 % were obtained between  $C_{\text{ref}}^*$ ,  $C_{\text{ref}}(\text{W2003})$  and  $C_{\text{ref}}(\text{C2010})$  at 450 and 660 nm for weakly absorbing dust and kaolinite. In contrast, for more absorbing ambient air aerosols the differences between  $C_{\text{ref}}^*$ ,  $C_{\text{ref}}(\text{W2003})$  and  $C_{\text{ref}}(\text{C2010})$  were in the range 2.7 to 24.3 %. The different ATT threshold, assumed here to be 20 % compared to W2003 and C2010 (10 %), has a negligible impact (less than 1 % difference) on the results. In some cases (ambient air 1–2 and Niger 1 sam-

ples), however, we obtained  $C_{\text{ref}}(\text{C2010}) > C_{\text{ref}}(\text{W2003})$ ; these cases correspond to a mean Aethalometer measured  $\text{ATT} < 10\%$ , for which  $R(\text{W2003}) > R(\text{C2010})$ , and this explains the larger  $C_{\text{ref}}(\text{C2010})$ . Conversely,  $C_{\text{ref}}(\text{C2010}) < C_{\text{ref}}(\text{W2003})$  when the measured  $\text{ATT}$  was  $\sim 15\text{--}20\%$ , yielding  $R(\text{W2003}) < R(\text{C2010})$ . The percent difference between the obtained  $C_{\text{ref}}(\text{W2003})$  and  $C_{\text{ref}}(\text{C2010})$  increased for decreasing SSA due to the increase of the  $R(\text{W2003})$  to  $R(\text{C2010})$  absolute difference for decreasing SSA. When averaging data for all ambient air samples, the two formulations yield very similar values. For example, at 660 nm the mean  $C_{\text{ref}}(\text{W2003})$  was 2.44

**Table 2.** Summary of experiments and results. The mean and the standard deviation of  $D_{\text{eff, fine}}$ ,  $D_{\text{eff, coarse}}$ , SSA at 450 and 660 nm,  $C_{\text{ref}}^*$ ,  $C_{\text{ref}}(\text{W2003})$ , and  $C_{\text{ref}}(\text{C2010})$  are reported. As a reminder,  $C_{\text{ref}}^*$  is the multiple scattering correction obtained when not taking into account the loading effect correction in Aethalometer data;  $C_{\text{ref}}(\text{W2003})$  and  $C_{\text{ref}}(\text{C2010})$  take the loading effect correction into account by using the parameterizations by Weingartner et al. (2003) (referred to as W2003) and Collaud Coen et al. (2010) (referred to as C2010), respectively. The maximum of the % difference between  $C_{\text{ref}}^*$ ,  $C_{\text{ref}}(\text{W2003})$ , and  $C_{\text{ref}}(\text{C2010})$  is indicated in the table.

Aerosol ID	Source	$D_{\text{eff, fine}}$ ( $\mu\text{m}$ ) $D_{\text{eff, coarse}}$ ( $\mu\text{m}$ )	SSA		$C_{\text{ref}}^*$ 450 nm 660 nm	$C_{\text{ref}}$ (W2003)		$C_{\text{ref}}$ (C2010)		Max % diff $C_{\text{ref}}$ 450 nm 660 nm
			450 nm 660 nm	450 nm 660 nm		450 nm 660 nm	450 nm 660 nm			
Ammonium sulfate	Sigma-Aldrich 99.999 % purity	–	$0.999 \pm (<)0.001$ $0.999 \pm (<)0.001$		–	–		–		–
Niger 1	Sahel (13.52° N, 2.63° E)	$0.38 \pm 0.01$ $2.6 \pm 0.1$	$0.93 \pm 0.01$ $0.98 \pm 0.01$	$2.00 \pm 0.45$ $1.87 \pm 0.51$	$2.01 \pm 0.45$ $1.87 \pm 0.51$	$2.02 \pm 0.45$ $1.88 \pm 0.51$			1.0 % 0.4 %	
Niger 2	Sahel (13.52° N, 2.63° E)	$0.32 \pm 0.02$ $2.3 \pm 0.1$	$0.92 \pm 0.01$ $0.98 \pm 0.01$	$2.05 \pm 0.46$ $1.89 \pm 0.57$	$2.11 \pm 0.47$ $1.92 \pm 0.56$	$2.10 \pm 0.47$ $1.92 \pm 0.57$			2.8 % 1.6 %	
China	Gobi desert (39.43° N, 105.67° E)	$0.44 \pm 0.01$ $3.1 \pm 0.2$	$0.94 \pm 0.01$ $0.98 \pm 0.01$	$2.15 \pm 0.48$ $2.02 \pm 0.62$	$2.16 \pm 0.48$ $2.01 \pm 0.62$	$2.16 \pm 0.48$ $2.02 \pm 0.63$			0.5 % 0.3 %	
Arizona	Sonoran desert (33.15° N, 112.08° W)	$0.53 \pm 0.02$ $3.1 \pm 0.2$	$0.96 \pm 0.01$ $0.99 \pm 0.01$	$1.81 \pm 0.40$ $1.76 \pm 0.56$	$1.82 \pm 0.41$ $1.78 \pm 0.55$	$1.82 \pm 0.41$ $1.78 \pm 0.57$			0.5 % 1.1 %	
Tunisia	Sahara desert (33.02° N, 10.67° E)	$0.48 \pm 0.03$ $3.2 \pm 0.7$	$0.96 \pm 0.01$ $0.99 \pm 0.01$	$1.97 \pm 0.49$ $1.80 \pm 0.42$	$1.98 \pm 0.44$ $1.80 \pm 0.42$	$1.98 \pm 0.44$ $1.80 \pm 0.42$			0.5 % 0 %	
Australia	Strzelecki desert (31.33° S, 140.33° E)	$0.55 \pm 0.02$ $2.4 \pm 0.1$	$0.85 \pm 0.01$ $0.98 \pm 0.01$	$2.52 \pm 0.56$ $2.28 \pm 0.74$	$2.56 \pm 0.57$ $2.26 \pm 0.72$	$2.56 \pm 0.57$ $2.28 \pm 0.74$			1.6 % 0.9 %	
Namibia	Namib desert (19.0° S, 13.0° E)	$0.45 \pm 0.04$ $3.6 \pm 0.3$	$0.95 \pm 0.01$ $0.98 \pm 0.01$	$2.02 \pm 0.45$ $1.75 \pm 0.57$	$2.03 \pm 0.45$ $1.76 \pm 0.54$	$2.03 \pm 0.45$ $1.79 \pm 0.57$			0.5 % 2.2 %	
Kaolinite	Source clay repository KGa-2	$0.39 \pm 0.07$ $2.3 \pm 1.6$	$0.96 \pm 0.01$ $0.97 \pm 0.01$	$2.47 \pm 0.55$ $2.31 \pm 0.60$	$2.51 \pm 0.56$ $2.34 \pm 0.60$	$2.50 \pm 0.56$ $2.33 \pm 0.60$			1.6 % 1.3 %	
Ambient air 1	Suburbs of Paris	$0.24 \pm 0.08$ $5.2 \pm 0.9$	$0.79 \pm 0.05$ $0.61 \pm 0.08$	$3.87 \pm 0.87$ $1.97 \pm 0.71$	$4.01 \pm 0.90$ $2.05 \pm 0.73$	$4.03 \pm 0.90$ $2.11 \pm 0.76$			4.0 % 6.6 %	
Ambient air 2	Suburbs of Paris	$0.50 \pm 0.02$ $4.5 \pm 0.1$	$0.72 \pm 0.04$ $0.67 \pm 0.09$	$3.22 \pm 0.72$ $1.66 \pm 0.44$	$3.68 \pm 0.82$ $1.94 \pm 0.52$	$3.57 \pm 0.80$ $1.87 \pm 0.50$			12.5 % 14.4 %	
Ambient air 3	Suburbs of Paris	$0.46 \pm 0.03$ $6.2 \pm 0.7$	$0.78 \pm 0.06$ $0.54 \pm 0.10$	$3.93 \pm 0.88$ $2.32 \pm 0.76$	$4.35 \pm 0.97$ $2.78 \pm 0.89$	$4.25 \pm 0.95$ $2.68 \pm 0.87$			21.1 % 16.5 %	
Ambient air 4	Suburbs of Paris	$0.53 \pm 0.05$ $5.3 \pm 1.3$	$0.63 \pm 0.05$ $0.42 \pm 0.08$	$3.41 \pm 0.76$ $2.25 \pm 0.68$	$3.90 \pm 0.87$ $2.69 \pm 0.81$	$3.79 \pm 0.85$ $2.62 \pm 0.79$			12.6 % 16.4 %	
Ambient air 5	Suburbs of Paris	$0.37 \pm 0.03$ $3.4 \pm 0.1$	$0.76 \pm 0.08$ $0.65 \pm 0.12$	$2.72 \pm 0.61$ $2.54 \pm 0.82$	$2.58 \pm 0.58$ $2.51 \pm 0.81$	$2.77 \pm 0.62$ $2.61 \pm 0.85$			5.4 % 2.7 %	
Ambient air 6	Suburbs of Paris	$0.37 \pm 0.05$ $4.1 \pm 1.0$	$0.62 \pm 0.04$ $0.46 \pm 0.09$	$2.75 \pm 0.50$ $2.24 \pm 0.60$	$2.78 \pm 0.62$ $2.96 \pm 0.79$	$2.66 \pm 0.59$ $2.79 \pm 0.75$			19.1 % 24.3 %	
Ambient air 7	Suburbs of Paris	$0.40 \pm 0.01$ $4.7 \pm 0.7$	$0.87 \pm 0.05$ $0.76 \pm 0.08$	$3.85 \pm 0.86$ $1.86 \pm 0.74$	$4.06 \pm 0.91$ $2.04 \pm 0.69$	$4.01 \pm 0.90$ $2.02 \pm 0.80$			5.2 % 8.8 %	
Ambient air 8	Suburbs of Paris	$0.42 \pm 0.07$ $4.3 \pm 0.7$	$0.78 \pm 0.06$ $0.71 \pm 0.07$	$1.91 \pm 0.43$ $2.09 \pm 0.61$	$2.22 \pm 0.50$ $2.53 \pm 0.73$	$2.16 \pm 0.48$ $2.45 \pm 0.72$			14.0 % 17.4 %	

( $\pm 0.38$ ), less than 2 % larger than the mean  $C_{\text{ref}}(\text{C2010})$  of  $2.39 (\pm 0.35)$ .

The mean and standard deviation of the multiple scattering correction at 450 and 660 nm for dust, kaolinite, and ambient air calculated as the mean of the  $C_{\text{ref}}^*$ ,  $C_{\text{ref}}(\text{W2003})$ , and  $C_{\text{ref}}(\text{C2010})$  are reported in Table 3. The mean  $C_{\text{ref}}$  at 450 and 660 nm is  $2.09 (\pm 0.22)$  and  $1.92 (\pm 0.17)$  for dust,  $2.49 (\pm 0.02)$  and  $2.31 (\pm 0.02)$  for kaolinite, and  $2.32 (\pm 0.36)$

and  $2.32 (\pm 0.35)$  for pollution aerosols. If the wavelength of 637 nm is assumed for the MAAP instead of 670 nm, as suggested by Müller et al. (2011), the average  $C_{\text{ref}}$  at 660 nm would increase by up to  $\sim 15\%$  for dust and ambient air ( $2.17 \pm 0.19$  and  $2.48 \pm 0.41$ , respectively) and  $\sim 3\%$  for kaolinite ( $2.40 \pm 0.02$ ).

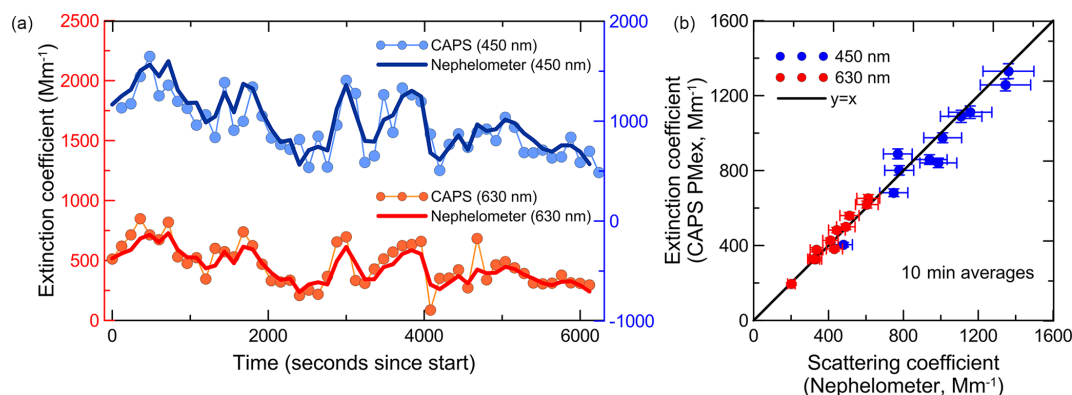

**Figure 3.** Ammonium sulfate experiment. (a) Temporal evolution of the extinction and scattering coefficients measured by the CAPS PMex and the nephelometer at 450 nm (blue scale) and 630 nm (red scale). Each point in the plot corresponds to 2 min average data. (b) CAPS PMex versus nephelometer data (10 min averages). The  $y = x$  line and the results of the linear fit between CAPS and nephelometer data are also shown in the plot.

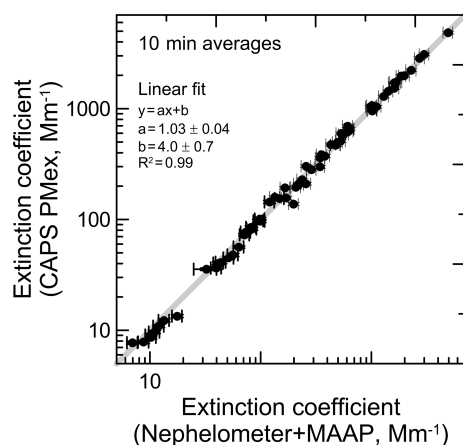

**Figure 4.** CAPS PMex extinction coefficient extrapolated at 660 nm versus nephelometer and MAAP calculated extinction at 660 nm for all experiments (dust, kaolinite, ambient air). Each point in the plot corresponds to 10 min average data. The  $y = x$  line and the results of the linear fit between CAPS and nephelometer and MAAP data are also shown in the plot.

### 4.3 Dependence of $C_{ref}$ on SSA

As reported in Table 2, very different SSA values at 450 and 660 nm were obtained for the various cases. For dust aerosols, the measured SSA values were larger than 0.85 at 450 nm and close to unity ( $>0.98$ ) at 660 nm, in line with field observations of dust from different sources (Schladitz et al., 2009; Formenti et al., 2011; Ryder et al., 2013). In particular, our results for China, Arizona, and Australia samples are in line with published values by Engelbrecht et al. (2016), who used a photoacoustic instrument to measure absorption of resuspended dust aerosols. This would suggest the similar performances of the Aethalometer compared to the photoacoustic technique. The SSA for kaolinite was 0.96–0.97

at 450 and 660 nm, in agreement with Utry et al. (2017), also using a photoacoustic method to measure absorption (0.97 and 0.99 ( $\pm 0.04$ ) at 450 and 635 nm, respectively). Both at 450 and 660 nm, the single scattering albedo for ambient air varied in the wide range of 0.2 to 0.9 during the whole measurement period (see Fig. 2 for measurements at 660 nm). The average values obtained for air samples 1–8 were 0.62–0.87 at 450 and 0.42–0.76 at 660 nm. The SSA decreased with increasing wavelength, as expected for pollution aerosols (e.g. Bergstrom et al., 2007; Di Biagio et al., 2016). The wide range of values indicates the occurrence of particles with very different absorption properties, hence chemical composition (or complex refractive index) and/or different size distribution (e.g. Moosmüller and Arnott, 2009). For instance, in urban environments, Bergstrom et al. (2007) reported SSA in the range 0.2–1.0 at 550 nm, with lowest values observed for soot-dominated air masses and highest values for urban pollution dominated by low-absorbing organic components.

The experimental SSA values serve two purposes. Firstly, as shown in Fig. 5, they are linearly related to the factor  $f$  in the loading effect correction term  $R$  in Eqs. (6a–b) as  $f = a(1 - \text{SSA}) + 1$ . The linear regression of our data yields a slope  $a = (1.48 \pm 0.14)$ , which is larger than the value of 0.85 reported in W2003 ( $f$  data from W2003 are also shown in Fig. 5) and 0.76 in C2010.

Secondly, SSA data serve to investigate the dependence of  $C_{ref}$  on relative amounts of particle absorption for mineral dust. As shown in Fig. 6 (top panel),  $C_{ref}$  for dust seems to be independent of SSA at 660 nm, whereas it decreases for increasing SSA at 450 nm. This trend is statistically significant (correlation coefficient of  $R^2 = 0.85$ ). The relationship between  $C_{ref}$  and SSA is also investigated in Fig. 6 (bottom panel) for all aerosol samples. Globally, Fig. 6 suggests a decrease of  $C_{ref}$  for increasing SSA, in particular at 450 nm, albeit with a poorer statistical significance at both

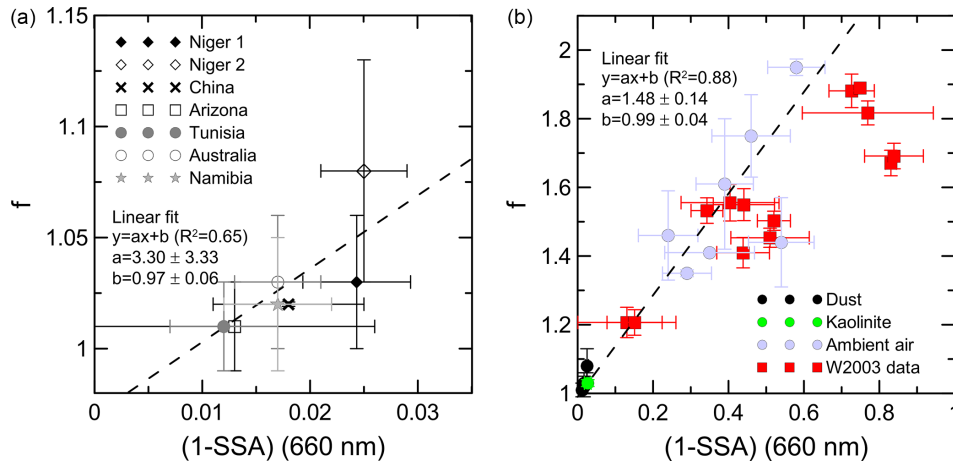

**Figure 5.** (a) Estimated  $f$  values versus  $(1 - SSA)$  at 660 nm for dust aerosols. Different symbols are used to distinguish between dust from different sources. The uncertainty of  $(1 - SSA)$  is the standard deviation over 2 min data, while that of  $f$  is calculated with the error propagation formula taking into account the uncertainty of  $a$  ( $\pm 0.14$ ) and that of  $(1 - SSA)$ . (b)  $f$  versus  $SSA$  at 660 nm for all experiments. Different symbols are used to distinguish between different aerosol types. The results of the linear fit between  $f$  and  $(1 - SSA)$  are also reported. Data from Weingartner et al. (2003) (W2003) (extracted from their Fig. 4) are also shown in the plot for comparison.

**Table 3.** Mean and standard deviation multiple scattering correction  $\overline{C_{ref}}$  at 450 and 660 nm for dust, kaolinite, and ambient air. The  $\overline{C_{ref}}$  was calculated as the mean of the  $C_{ref}^*$ ,  $C_{ref}(W2003)$ , and  $C_{ref}(C2010)$  obtained at each wavelength for the different aerosol types. As a reminder,  $C_{ref}^*$  is the multiple scattering correction obtained when not taking into account the loading effect correction in Aethalometer data;  $C_{ref}(W2003)$  and  $C_{ref}(C2010)$  take the loading effect correction into account by using the parameterizations by Weingartner et al. (2003) and Collaud Coen et al. (2010), respectively.

	$\overline{C_{ref}}$	
	450 nm	660 nm
Mineral dust	$2.09 \pm 0.22$	$1.92 \pm 0.17$
Kaolinite	$2.49 \pm 0.02$	$2.31 \pm 0.02$
Ambient air	$3.31 \pm 0.75$	$2.32 \pm 0.35$

wavelengths ( $R^2 = 0.35$  and  $0.59$ ). Data are also compared to those reported in W2003 and C2010 at 660 nm for different aerosol types. Diesel soot and soot mixed with ammonium sulfate were investigated in W2003, while C2010 reported data for ambient aerosols sampled at different locations in Europe and in Amazonia. W2003 also reported the  $C_{ref}$  for soot particles at 450 nm (not shown in Fig. 6), with values between 2.08 and 3.64; these values are in line with our observations at 450 nm for ambient air. However, as illustrated in Fig. 6, both W2003 and C2010 found a relationship between  $C_{ref}$  and  $SSA$  at 660 nm. Contrasting results are obtained when plotting the two data sets together. C2010 obtained a sharp and almost linear decrease of  $C_{ref}$  with increasing  $SSA$  ( $C_{ref} \sim 5-2.5$  for  $SSA \sim 0.65-0.9$ ), while W2003 data showed a pronounced decrease of  $C_{ref}$  ( $\sim 2-4$ ) for in-

creasing  $SSA$  in the range 0.5 and 0.7 and low  $C_{ref}$  values ( $\sim 2$ ) at  $SSA \sim 0.2$ . Our data for dust and kaolinite at high  $SSA$  ( $> 0.97$ ) seem to follow the same linear relationship as C2010. However at lower  $SSA$ , our data for ambient aerosols are closer to W2003 results at 660 nm. These differences between W2003 and C2010 data, and also with our results, are quite difficult to explain. The main difference between W2003 compared to C2010 is that W2003 performed measurements in a simulation chamber, while C2010 was a field study. Working in ambient conditions may influence the retrieved  $C_{ref}$ . In fact, volatile-organic compounds or water vapour present in the atmosphere may condense on the filter (Lack et al., 2008), thus enhancing the scattering from the filter fibres and leading to higher  $C_{ref}$ . This could explain the higher  $C_{ref}$  obtained in C2010 compared to W2003. Our results for ambient air particles, however, are in agreement with W2003 chamber results. Differences in the size distributions of the investigated aerosols are also expected to possibly affect the comparison; however, no detailed information on the size of investigated aerosols is provided in W2003 and C2010. Another source of discrepancy may be in the fact that, in contrast to W2003 and our study, where the Aethalometer and MAAP were compared at 660 nm,  $C_{ref}$  in C2010 was estimated by comparing Aethalometer data at 660 nm with MAAP observations at 630 nm. As aerosol absorption increases with decreasing wavelength, this wavelength difference may induce an underestimation of  $C_{ref}$  in C2010.

#### 4.4 Dependence of $C_{ref}$ on particles size

Examples of the number size distribution measured by the SMPS and OPC for ammonium sulfate, Niger dust, kaolin-

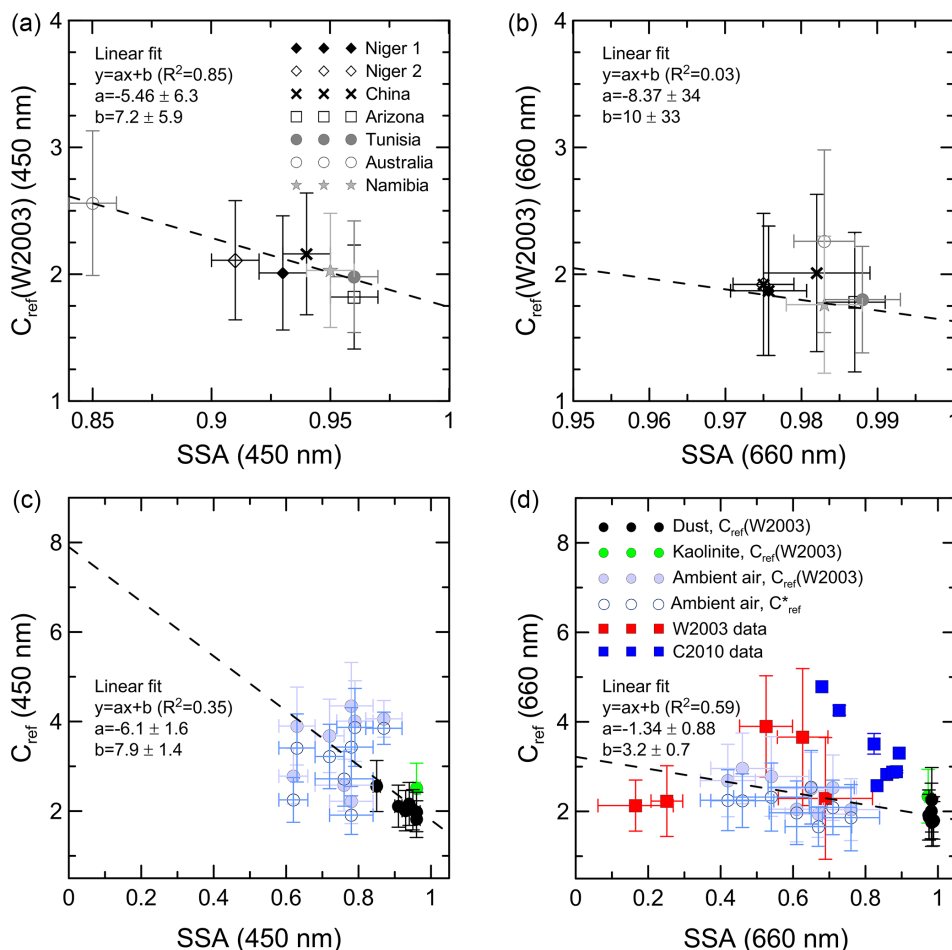
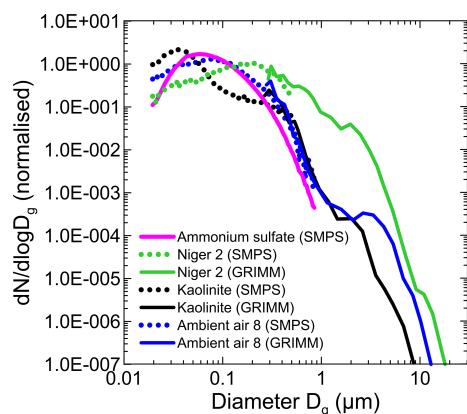

**Figure 6.** (a, b)  $C_{\text{ref}}(\text{W2003})$  (multiple scattering correction obtained by taking into account the loading effect correction using the parameterizations by Weingartner et al., 2003) versus SSA at 450 and 660 nm for mineral dust samples analysed in this study. Different symbols are used to distinguish between dust from different sources. As indicated in Table 2, the difference between  $C_{\text{ref}}^*$ ,  $C_{\text{ref}}(\text{W2003})$ , and  $C_{\text{ref}}(\text{C2010})$  is very low for mineral dust aerosols. The uncertainty of SSA is the standard deviation over 2 min data, while that of  $C_{\text{ref}}(\text{W2003})$  is calculated with the error propagation formula taking into account the uncertainty of  $\beta_{\text{abs,ref}}$  and that of  $\beta_{\text{ATT}}/R(\text{W2003})$ . (c, d)  $C_{\text{ref}}$  versus SSA at 450 and 660 nm for the different aerosol samples analysed in this study. Different symbols are used to distinguish between different aerosol types. Data for both  $C_{\text{ref}}(\text{W2003})$  and  $C_{\text{ref}}^*$  (multiple scattering correction obtained while not taking into account the loading effect correction in Aethalometer data) are shown for ambient air aerosols, while for dust and kaolinite, for which the difference between the different formulations is very low, only  $C_{\text{ref}}(\text{W2003})$  is reported. Data from Weingartner et al. (2003) (W2003) ( $C_{\text{ref}}$  from their Table 3, and SSA extracted from their Fig. 4) and Collaud Coen et al. (2010) (C2010) (extracted from their Fig. 5) at 660 nm are also shown in the plot for comparison. The results of the linear fits between  $C_{\text{ref}}$  and SSA for mineral dust and for the entire data set are also shown in the plot.

ite, and ambient air are shown in Fig. 7. Ammonium sulfate had mostly a submicron distribution, while dust aerosols presented the largest fraction over the whole supermicron range up to about 10–20  $\mu\text{m}$ . Dust particles larger than 20  $\mu\text{m}$  were completely suppressed by the impactor system and were not detected by the OPC. The coarse component, up to about 10  $\mu\text{m}$ , was also identified in the kaolinite and ambient air samples. In particular, a defined mode at  $\sim 4 \mu\text{m}$  was detected in the number distribution of ambient air particles, and may be linked to the presence of soot aggregates, tire abrasions, resuspended road dust, or bioaerosols (Harrison et al., 2001; Bauer et al., 2008; Pakbin et al., 2010; Liu and Har-

ison, 2011). The  $D_{\text{eff, fine}}$  varied between 0.24 and 0.62  $\mu\text{m}$  and the  $D_{\text{eff, coarse}}$  between 2.3 and 6.2  $\mu\text{m}$  for the different cases (Table 2). For mineral dust,  $D_{\text{eff, coarse}}$  ranged between 2.3 and 3.6  $\mu\text{m}$ , encompassing the value of  $D_{\text{eff, coarse}} \sim 3 \mu\text{m}$  reported by Denjean et al. (2016b) in their Fig. 11 for Saharan dust, both close to sources and during transport over the Atlantic.

These observations are consistent with the extinction ( $\alpha_{\text{E}}$ ) and the absorption ( $\alpha_{\text{A}}$ ) Ångström exponent measured during the experiments. The  $\alpha_{\text{E}}$  (shown in Fig. 2) was  $\sim 0$  for kaolinite, varied between about 0 and 2 for mineral dust aerosols, and between 0.5 and 2.5 for ambient air, indicat-



**Figure 7.** Examples of number size distribution (normalized to the total number concentration) for ammonium sulfate, dust (Niger sample), kaolinite, and ambient air aerosols. Data refer to the mean over each experiment as measured from the SMPS and the OPC. Error bars (standard deviations) have been omitted for the sake of clarity.

ing particles with variable sizes, both the submicron and the supermicron fractions. The absorption Ångström coefficient  $\alpha_A$  obtained from Aethalometer data was between 2.2 and 4 for dust, between 1 and 1.5 for kaolinite and between 0.5 and 1.5 for ambient air aerosols.

The dependence of  $C_{\text{ref}}$  at 450 and 660 nm on the effective fine  $D_{\text{eff, fine}}$  and coarse  $D_{\text{eff, coarse}}$  diameters as a measure of particle size was investigated. The scatter plot of  $C_{\text{ref}}$  versus  $D_{\text{eff, coarse}}$  is shown in Fig. 8 and indicates that the  $C_{\text{ref}}$  does not have any statistically significant dependence on the particle size for mineral dust at both wavelengths and for all data at 660 nm ( $R^2 \leq 0.40$ ). Conversely, a slight increase of  $C_{\text{ref}}$  for increasing  $D_{\text{eff, coarse}}$  is obtained at 450 nm when all aerosol samples are considered ( $R^2 = 0.70$ ). In contrast, no dependence of  $C_{\text{ref}}$  on  $D_{\text{eff, fine}}$  is found ( $R^2 \leq 0.44$ , not shown).

## 5 Conclusions

In this paper we presented an intercomparison study between an Aethalometer and a MAAP, a nephelometer, and two CAPS with the aim of determining a two-wavelength multiple scattering correction ( $C_{\text{ref}}$ ) for Aethalometer measurements for weakly absorbing mineral dust aerosols. Mineral dust aerosols investigated here were generated from natural parent soils collected in desert areas, both in the northern and southern hemispheres (Di Biagio et al., 2014, 2017). The size distribution of the generated dust included both the submicron and the supermicron fractions, with an effective fine and coarse diameter between 0.32–0.55 and 2.3–3.6  $\mu\text{m}$ , respectively.

The estimated  $C_{\text{ref}}$  was in the range 1.81–2.56 at 450 nm and 1.75–2.28 at 660 nm for the different dust samples, with

mean  $C_{\text{ref}}$  values of 2.09 ( $\pm 0.22$ ) and 1.92 ( $\pm 0.17$ ), respectively. Using these values of  $C_{\text{ref}}$ , the dust absorption coefficient estimated by the Aethalometer will be about 2 % (450 nm) and 11 % (660 nm) higher than obtained by using the wavelength-independent value of 2.14, which is commonly used in the literature (e.g. Sandradewi et al., 2008; Formenti et al., 2011; Di Biagio et al., 2016). The new estimate of  $C_{\text{ref}}$  has a negligible impact on the dust SSA at 450 nm (less than 0.5 % difference between the value obtained for  $C_{\text{ref}} = 2.09$  or 2.14), but affects the estimate of SSA by up to  $\sim 3$  % at 660 nm.

Given that the median of the solar spectrum occurs at about 700 nm, the expected change in the dust SSA at 660 nm may significantly affect the impact of dust on radiation. Mallet et al. (2009) estimated that about a 3 % change in the visible SSA of dust may determine up to a 10 % change in the radiative effect of dust at the surface, and up to 20 % change at the top of the atmosphere, with a net  $\sim 25$  % increase of dust absorption in the atmosphere. Given the strong sensitivity of the dust direct effect to particle absorption (Solmon et al., 2008; Mallet et al., 2009; Di Biagio et al., 2010; Jin et al., 2016, among others), we recommend this new  $C_{\text{ref}}$  value at 660 nm to be used when analysing Aethalometer data for mineral dust aerosols.

The analysis performed in this study indicates that there is no dependence of  $C_{\text{ref}}$  on the coarse component of the particle size distribution for dust. This suggests that the  $C_{\text{ref}}$  obtained here can be used to correct Aethalometer data for dust at the time of emission, when the coarse fraction dominates the dust size distribution, as well as after long-range transport, when the coarsest component of dust has preferentially settled out.

Finally, our body of observations, spanning a wide range of SSA values from 0.96–0.97 (kaolinite) to  $\sim 0.4$ –0.8 (ambient urban aerosols), indicates that  $C_{\text{ref}}$  decreases for increasing SSA, both at 450 and 660 nm. This is generally consistent with the results of W2003 and C2010 at 660 nm. However, a unique relationship cannot be established. At high SSA ( $> 0.90$ ), our data, as well as those of C2010, suggest a sharper decrease than at SSA in the range 0.4–0.8, whereas our data are more consistent with those of W2003. Differences in aerosol sampling conditions and in the exact analysed wavelengths from the three studies may be the cause of such a discrepancy, but clear conclusions, as well as an explicit relationship between  $C_{\text{ref}}$  and SSA, are still difficult to state. Similarly, our observations seem to indicate that  $C_{\text{ref}}$  increases for increasing  $D_{\text{eff, coarse}}$  at 450 nm. This trend was only observed when the entire data set was considered, and not when the data set was limited to just the dust observations, making it difficult to draw clear conclusions.

A more extensive characterization of  $C_{\text{ref}}$  is required to provide an appropriate correction of Aethalometer data under the wide range of atmospheric conditions.

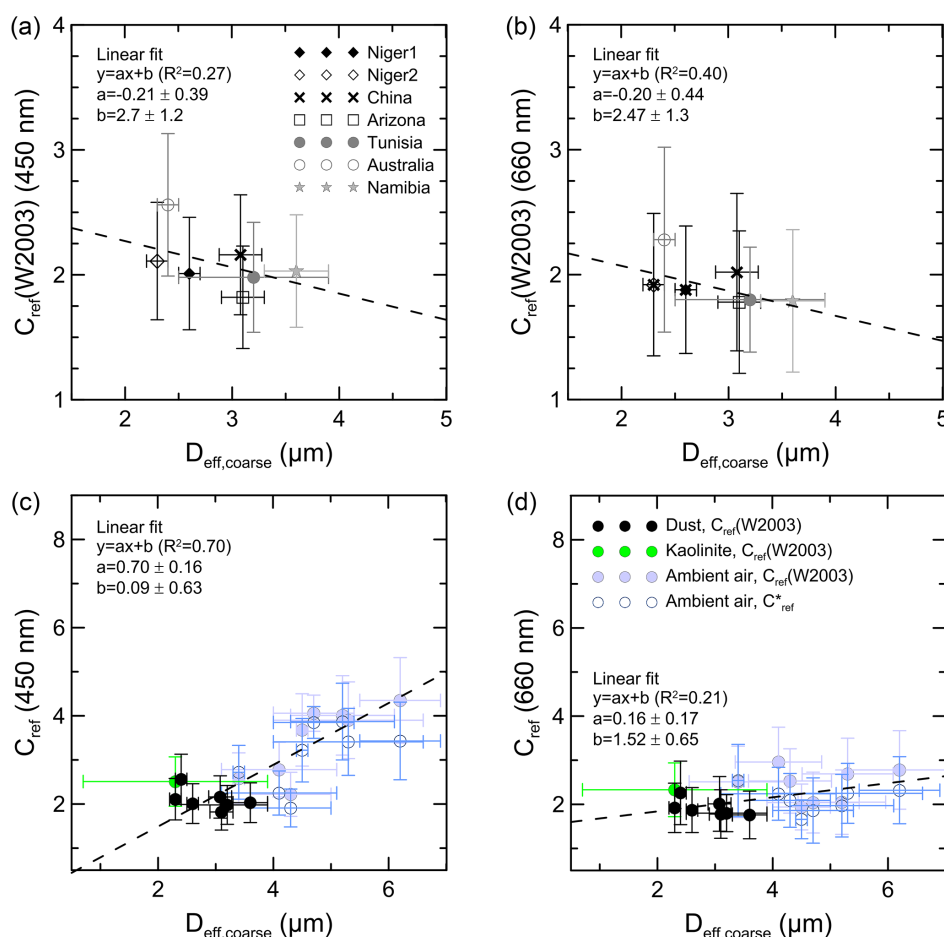

**Figure 8.** (a, b)  $C_{ref}(W2003)$  (multiple scattering correction obtained by taking into account the loading effect correction using the parameterizations by Weingartner et al., 2003) at 450 and 660 nm versus the effective diameter coarse  $D_{eff,coarse}$  for mineral dust samples analysed in this study. Different symbols are used to distinguish between dust from different sources. The uncertainty of  $D_{eff,coarse}$  is the standard deviation over 2 min data, while that of  $C_{ref}(W2003)$  is calculated with the error propagation formula taking into account the uncertainty of  $\beta_{abs,ref}$  and that of  $\beta_{ATT}/R(W2003)$ . (c, d)  $C_{ref}$  at 450 and 660 nm versus the effective diameter coarse  $D_{eff,coarse}$  for the different aerosol samples analysed in this study. Different symbols are used to distinguish between different aerosol types. Data for both  $C_{ref}(W2003)$  and  $C_{ref}^*$  (multiple scattering correction obtained while not taking into account the loading effect correction in Aethalometer data) are shown for ambient air aerosols, while for dust and kaolinite, for which the difference between the different formulations is very low, only  $C_{ref}(W2003)$  is reported. The results of the linear fits between  $C_{ref}$  and  $D_{eff,coarse}$  for mineral dust and for the entire data set are also shown in the plot.

**Data availability.** Experimental and processed data are available upon request to the contact author.

**Author contributions.** CDB and PF designed the experiments, discussed the results, and wrote the manuscript with comments from all co-authors. NM provided the MAAP used in the experiments. CDB, MC, and EP performed the experiments. CDB performed the data analysis.

**Competing interests.** The authors declare that they have no conflict of interest.

**Acknowledgements.** The RED-DUST project was supported by the French national programme LEFE/INSU, by the Institut Pierre Simon Laplace (IPSL), and by OSU-EFLUVE (Observatoire des Sciences de l'Univers-Enveloppes Fluides de la Ville à l'Exobiologie) through dedicated research funding. Claudia Di Biagio was supported by the CNRS via the Labex L-IPSL, which is funded by the ANR (grant no. ANR-10-LABX-0018). This work has also received funding from the European Union's Horizon 2020 (H2020) research and innovation programme through the EUROCHAMP-2020 Infrastructure Activity under grant agreement No 730997. The authors thank Konrad Kandler, Dave Seibert, and the LISA staff who collected the soil samples used in this study, Emilie Journet who provided the kaolinite sample, Andreas Petzold for helpful discussions on the Aethalometer multiple scattering effects, and Benjamin Tamime-Roussel for logistic help with

the MAAP. The three anonymous reviewers are also gratefully acknowledged for their helpful comments which allowed us to improve and clarify the manuscript.

Edited by: Pierre Herckes

Reviewed by: three anonymous referees

## References

- Anderson, T. L. and Ogren, J. A.: Determining aerosol radiative properties using the TSI 3563 integrating nephelometer, *Aerosol Sci. Technol.*, 29, 57–69, 1998.
- Andreae, M. O. and Gelencsér, A.: Black carbon or brown carbon? The nature of light-absorbing carbonaceous aerosols, *Atmos. Chem. Phys.*, 6, 3131–3148, <https://doi.org/10.5194/acp-6-3131-2006>, 2006.
- Arnott, W. P., Hamasha, K., Moosmüller, H., Sheridan, P. J., and Ogren, J. A.: Towards aerosol light-absorption measurements with a 7-wavelength aethalometer: Evaluation with a photoacoustic instrument and 3-wavelength nephelometer, *Aerosol Sci. Technol.*, 39, 17–29, 2005.
- Backman, J., Schmeisser, L., Virkkula, A., Ogren, J. A., Asmi, E., Starkweather, S., Sharma, S., Eleftheriadis, K., Uttal, T., Jefferson, A., Bergin, M., and Makshtas, A.: On Aethalometer measurement uncertainties and multiple scattering enhancement in the Arctic, *Atmos. Meas. Tech. Discuss.*, <https://doi.org/10.5194/amt-2016-294>, in review, 2016.
- Balkanski, Y., Schulz, M., Claquin, T., and Guibert, S.: Reevaluation of Mineral aerosol radiative forcings suggests a better agreement with satellite and AERONET data, *Atmos. Chem. Phys.*, 7, 81–95, <https://doi.org/10.5194/acp-7-81-2007>, 2007.
- Bauer, H., Schueller, E., Weinke, G., Berger, A., Hitzemberger, R., Marr, I. L., and Puxbaum, H.: Significant contributions of fungal spores to the organic carbon and to the aerosol mass balance of the urban atmospheric aerosol, *Atmos. Environ.*, 42, 5542–5549, 2008.
- Bergstrom, R. W., Pilewskie, P., Russell, P. B., Redemann, J., Bond, T. C., Quinn, P. K., and Sierau, B.: Spectral absorption properties of atmospheric aerosols, *Atmos. Chem. Phys.*, 7, 5937–5943, <https://doi.org/10.5194/acp-7-5937-2007>, 2007.
- Caponi, L., Formenti, P., Massabó, D., Di Biagio, C., Cazaunau, M., Pangui, E., Chevaillier, S., Landrot, G., Andreae, M. O., Kandler, K., Piketh, S., Saeed, T., Seibert, D., Williams, E., Balkanski, Y., Prati, P., and Doussin, J.-F.: Spectral- and size-resolved mass absorption efficiency of mineral dust aerosols in the shortwave spectrum: a simulation chamber study, *Atmos. Chem. Phys.*, 17, 7175–7191, <https://doi.org/10.5194/acp-17-7175-2017>, 2017.
- Cattrall, C., Carder, K. L., and Gordon, H. R.: Columnar aerosol single-scattering albedo and phase function retrieved from sky radiance over the ocean: measurements of Saharan dust, *J. Geophys. Res.*, 108, 4287, <https://doi.org/10.1029/2002JD002497>, 2003.
- Collaud Coen, M., Weingartner, E., Apituley, A., Ceburnis, D., Fierz-Schmidhauser, R., Flentje, H., Henzing, J. S., Jennings, S. G., Moerman, M., Petzold, A., Schmid, O., and Baltensperger, U.: Minimizing light absorption measurement artifacts of the Aethalometer: evaluation of five correction algorithms, *Atmos. Meas. Tech.*, 3, 457–474, <https://doi.org/10.5194/amt-3-457-2010>, 2010.
- DeCarlo, P., Worsnop, D. R., Slowik, J. G., Davidovits, P., and Jimenez, J. L.: Particle Morphology and Density Characterization by Combined Mobility and Aerodynamic Diameter Measurements. Part 1: Theory, *Aerosol Sci. Technol.*, 38, 1185–1205, 2004.
- Denjean, C., Formenti, P., Desboeufs, K., Chevaillier, S., Triquet, S., Maillé, M., Cazaunau, M., Laurent, B., Mayol-Bracero, O. L., Vallejo, P., Quiñones, M., Gutierrez-Molina, I. E., Cassola, F., Prati, P., Andrews, E., and Ogren, J.: Size distribution and optical properties of African mineral dust after intercontinental transport, *J. Geophys. Res.-Atmos.*, 121, 7117–7138, <https://doi.org/10.1002/2016JD024783>, 2016a.
- Denjean, C., Cassola, F., Mazzino, A., Triquet, S., Chevaillier, S., Grand, N., Bourriane, T., Momboisse, G., Sellegri, K., Schwarzenbock, A., Freney, E., Mallet, M., and Formenti, P.: Size distribution and optical properties of mineral dust aerosols transported in the western Mediterranean, *Atmos. Chem. Phys.*, 16, 1081–1104, <https://doi.org/10.5194/acp-16-1081-2016>, 2016b.
- Di Biagio, C., di Sarra, A., and Meloni, D.: Large atmospheric shortwave radiative forcing by Mediterranean aerosols derived from simultaneous ground-based and spaceborne observations and dependence on the aerosol type and single scattering albedo, *J. Geophys. Res.*, 115, D10209, <https://doi.org/10.1029/2009JD012697>, 2010.
- Di Biagio, C., Formenti, P., Styler, S. A., Pangui, E., and Doussin, J.-F.: Laboratory chamber measurements of the longwave extinction spectra and complex refractive indices of African and Asian mineral dusts, *Geophys. Res. Lett.*, 41, 6289–6297, <https://doi.org/10.1002/2014GL060213>, 2014.
- Di Biagio, C., Formenti, P., Doppler, L., Gaimoz, C., Grand, N., Ancellet, G., Attié, J.-L., Bucci, S., Dubuisson, P., Fierli, F., Mallet, M., and Ravetta, F.: Continental pollution in the Western Mediterranean basin: large variability of the aerosol single scattering albedo and influence on the direct shortwave radiative effect, *Atmos. Chem. Phys.*, 16, 10591–10607, <https://doi.org/10.5194/acp-16-10591-2016>, 2016.
- Di Biagio, C., Formenti, P., Balkanski, Y., Caponi, L., Cazaunau, M., Pangui, E., Journet, E., Nowak, S., Caquineau, S., Andreae, M. O., Kandler, K., Saeed, T., Piketh, S., Seibert, D., Williams, E., and Doussin, J.-F.: Global scale variability of the mineral dust long-wave refractive index: a new dataset of in situ measurements for climate modeling and remote sensing, *Atmos. Chem. Phys.*, 17, 1901–1929, <https://doi.org/10.5194/acp-17-1901-2017>, 2017.
- di Sarra, A., Di Biagio, C., Meloni, D., Monteleone, F., Pace, G., Pugnaghi, S., and Sferlazzo, D.: Shortwave and longwave radiative effects of the intense Saharan dust event of March 25–26, 2010, at Lampedusa (Mediterranean sea), *J. Geophys. Res.*, 116, D23209, <https://doi.org/10.1029/2011JD016238>, 2011.
- Egan, W. G. and Hilgeman, T. W.: *Optical Properties of Inhomogeneous Materials: Applications to Geology, Astronomy, Chemistry, and Engineering*, Academic Press, New York, USA, 235 pp., 1979.
- Engelbrecht, J. P., Moosmüller, H., Pincock, S., Jayanty, R. K. M., Lersch, T., and Casuccio, G.: Technical note: Mineralogical, chemical, morphological, and optical interrelationships of min-



- eral dust re-suspensions, *Atmos. Chem. Phys.*, 16, 10809–10830, <https://doi.org/10.5194/acp-16-10809-2016>, 2016.
- Fialho, P., Hansenb, A. D. A., and Honrath, R. E.: Absorption coefficients by aerosols in remote areas: a new approach to decouple dust and black carbon absorption coefficients using seven-wavelength Aethalometer data, *Aerosol Sci.*, 36, 267–282, 2005.
- Formenti, P., Rajot, J. L., Desboeufs, K., Saïd, F., Grand, N., Chevaillier, S., and Schmechtig, C.: Airborne observations of mineral dust over western Africa in the summer Monsoon season: spatial and vertical variability of physico-chemical and optical properties, *Atmos. Chem. Phys.*, 11, 6387–6410, <https://doi.org/10.5194/acp-11-6387-2011>, 2011.
- Goudie A. S. and Middleton, N. J.: *Desert dust in the global system*, Springer, Berlin, Heidelberg, New York, 2006.
- Hansen, A. D. A., Rosen, H., and Novakov, T.: The aethalometer – an instrument for the real-time measurement of optical absorption by aerosol particles, *Sci. Total Environ.*, 36, 191–196, 1984.
- Harrison, R. M., Yin, J., Mark, D., Stedman, J., Appleby, R. S., Booker, J., and Moorcroft, S.: Studies of the coarse particle (2.5–10  $\mu\text{m}$ ) component in UK urban atmospheres, *Atmos. Environ.*, 35, 3667–3679, 2001.
- Heim, M., Mullins, B. J., Umhauer, H., and Kasper, G.: Performance evaluation of three optical particle counters with an efficient “multimodal” calibration method, *J. Aerosol Sci.*, 39, 1019–1031, 2008.
- Heinold, B., Tegen, I., Schepanski, K., and Hellmuth, O.: Dust radiative feedback on Saharan boundary layer dynamics and dust mobilization, *Geophys. Res. Lett.*, 35, L20817, <https://doi.org/10.1029/2008GL035319>, 2008.
- Highwood, E. J. and Ryder, C. L.: Radiative Effects of Dust, in: *Mineral Dust: A Key Player in the Earth System*, edited by: Knippertz, P. and Stuut, J.-B. W., Springer ScienceCBusiness Media, Dordrecht, [https://doi.org/10.1007/978-94-017-8978-3\\_11](https://doi.org/10.1007/978-94-017-8978-3_11), 2014.
- Horvath, H.: Atmospheric Light Absorption – A Review, *Atmos. Environ.*, 27A, 293–317, 1993.
- Jin, Q., Zang, Z.-L., and Wei, J.: High sensitivity of Indian summer monsoon to Middle East dust absorptive properties, *Sci. Rep.*, 6, 30690, <https://doi.org/10.1038/srep30690>, 2016.
- Kandler, K., Schütz, L., Deutscher, C., Ebert, M., Hofmann, H., Jäckel, S., Jaenicke, R., Knippertz, P., Lieke, K., Massling, A., Petzold, A., Schladitz, A., Weinzierl, B., Wiedensohler, A., Zorn, S., and Weinbruch, S.: Size distribution, mass concentration, chemical and mineralogical composition and derived optical parameters of the boundary layer aerosol at Tinfou, Morocco, during SAMUM 2006, *Tellus B*, 61, 32–50, <https://doi.org/10.1111/j.1600-0889.2008.00385.x>, 2009.
- Lack, D. A., Cappa, C. D., Covert, D. S., Baynard, T., Massoli, P., Sierau, B., Bates, T. S., Quinn, P. K., Lovejoy, E. R., and Ravishankara, A. R.: Bias in Filter-Based Aerosol Light Absorption Measurements Due to Organic Aerosol Loading: Evidence from Ambient Measurements, *Aerosol Sci. Technol.*, 42, 1033–1041, 2008.
- Liu, X. J. and Harrison, R. M.: Properties of coarse particles in the atmosphere of the United Kingdom, *Atmos. Environ.*, 45, 3267–3276, 2011.
- Mallet, M., Tulet, P., Serça, D., Solmon, F., Dubovik, O., Pelon, J., Pont, V., and Thouron, O.: Impact of dust aerosols on the radiative budget, surface heat fluxes, heating rate profiles and convective activity over West Africa during March 2006, *Atmos. Chem. Phys.*, 9, 7143–7160, <https://doi.org/10.5194/acp-9-7143-2009>, 2009.
- Massoli, P., Kebebian, P. L., Onasch, T. B., Hills, F. B., and Freedman, A.: Aerosol Light Extinction Measurements by Cavity Attenuated Phase Shift (CAPS) Spectroscopy: Laboratory Validation and Field Deployment of a Compact Aerosol Particle Extinction Monitor, *Aerosol Sci. Technol.*, 44, 428–435, <https://doi.org/10.1080/02786821003716599>, 2010.
- Miller, R. L., Tegen, I., and Perlwitz, J. P.: Surface radiative forcing by soil dust aerosols and the hydrologic cycle, *J. Geophys. Res.*, 109, D04203, <https://doi.org/10.1029/2003JD004085>, 2004.
- Miller, R. L., Knippertz, P., Pérez García-Pando, C., Perlwitz, J. P., and Tegen, I.: Impact of dust radiative forcing upon climate. In *Mineral Dust: A Key Player in the Earth System*, edited by: Knippertz, P. and Stuut, J.-B. W., Springer, 327–357, [https://doi.org/10.1007/978-94-017-8978-3\\_13](https://doi.org/10.1007/978-94-017-8978-3_13), 2014.
- Moosmüller, H. and Arnott, W. P.: Particle Optics in the Rayleigh Regime, *J. Air Waste Manage.*, 59, 1028–1031, 2009.
- Moosmüller, H., Chakrabarty, R. K., and Arnott, W. P.: Aerosol Light Absorption: A Review, *J. Quant. Spectrosc. Ra.*, 110, 844–878, 2009.
- Müller, T., Henzing, J. S., de Leeuw, G., Wiedensohler, A., Alastuey, A., Angelov, H., Bizjak, M., Collaud Coen, M., Engström, J. E., Gruening, C., Hillamo, R., Hoffer, A., Imre, K., Ivanow, P., Jennings, G., Sun, J. Y., Kalivitis, N., Karlsson, H., Komppula, M., Laj, P., Li, S.-M., Lunder, C., Marinoni, A., Martins dos Santos, S., Moerman, M., Nowak, A., Ogren, J. A., Petzold, A., Pichon, J. M., Rodriguez, S., Sharma, S., Sheridan, P. J., Teinilä, K., Tuch, T., Viana, M., Virkkula, A., Weingartner, E., Wilhelm, R., and Wang, Y. Q.: Characterization and intercomparison of aerosol absorption photometers: result of two intercomparison workshops, *Atmos. Meas. Tech.*, 4, 245–268, <https://doi.org/10.5194/amt-4-245-2011>, 2011.
- Pakbin, P., Hudda, N., Cheng, K. L., Moore, K. F., and Sioutas, C.: Spatial and temporal variability of coarse (PM<sub>10-2.5</sub>) particulate matter concentrations in the Los Angeles area, *Aerosol Sci. Technol.*, 44, 514–525, 2010.
- Perez, C., Nickovic, S., Baldasano, J. M., Sicard, M., Rocadenbosch, F., and Cachorro, V. E.: A long Saharan dust event over the western Mediterranean: Lidar, Sun photometer observations, and regional dust modeling, *J. Geophys. Res.*, 111, D15214, <https://doi.org/10.1029/2005JD006579>, 2006.
- Petzold, A. and Schönlinner, M.: Multiangle Absorption Photometry? A New Method for the Measurement of Aerosol Light Absorption and Atmospheric Black Carbon, *J. Aerosol Sci.*, 35, 421–441, 2004.
- Petzold, A., Schloesser, H., Sheridan, P. J., Arnott, W. P., Ogren, J. A., and Virkkula, A.: Evaluation of Multi-angle Absorption Photometry for Measuring Aerosol Light Absorption, *Aerosol Sci. Technol.*, 39, 40–51, 2005.
- Querol, X., Pey, J., Pandolfi, M., Alastuey, A., Cusack, M., Pérez, N., Moreno, T., Viana, M., Mihalopoulos, N., Kallos, G., and Kleanthous, S.: African dust contributions to mean ambient PM<sub>10</sub> mass-levels across the Mediterranean Basin, *Atmos. Environ.*, 43, 4266–4277, 2009.
- Reddy, M. S., Boucher, O., Balkanski, Y., and Schulz, M.: Aerosol optical depths and direct radiative perturbations by

- species and source type, *Geophys. Res. Lett.*, 32, L12803, <https://doi.org/10.1029/2004GL021743>, 2005.
- Redmond, H. E., Dial, K. D., and Thompson, J. E.: Light scattering and absorption by wind blown dust: Theory, measurement, and recent data, *Aeolian Res.*, 2, 5–26, 2010.
- Ryder, C. L., Highwood, E. J., Rosenberg, P. D., Trembath, J., Brooke, J. K., Bart, M., Dean, A., Crosier, J., Dorsey, J., Brindley, H., Banks, J., Marsham, J. H., McQuaid, J. B., Sodemann, H., and Washington, R.: Optical properties of Saharan dust aerosol and contribution from the coarse mode as measured during the Fennec 2011 aircraft campaign, *Atmos. Chem. Phys.*, 13, 303–325, <https://doi.org/10.5194/acp-13-303-2013>, 2013.
- Sandradewi, J., Prévôt, A. S. H., Weingartner, E., Schmidhauser, R., Gysel, M., and Baltensperger, U.: A study of wood burning and traffic aerosols in an Alpine valley using a multi-wavelength Aethalometer, *Atmos. Environ.*, 42, 101–112, 2008.
- Saturno, J., Pöhlker, C., Massabò, D., Brito, J., Carbone, S., Cheng, Y., Chi, X., Ditas, F., Hrabec de Angelis, I., Morán-Zuloaga, D., Pöhlker, M. L., Rizzo, L. V., Walter, D., Wang, Q., Artaxo, P., Prati, P., and Andreae, M. O.: Comparison of different Aethalometer correction schemes and a reference multi-wavelength absorption technique for ambient aerosol data, *Atmos. Meas. Tech. Discuss.*, <https://doi.org/10.5194/amt-2016-361>, in review, 2016.
- Schladitz, A., Müller, T., Kaaden, N., Massling, A., Kandler, K., Ebert, M., Weinbruch, S., Deutscher, C., and Wiedensohler, A.: In situ measurements of optical properties at Tin-fou (Morocco) during the Saharan Mineral Dust Experiment SAMUM 2006, *Tellus B*, 61, 64–78, <https://doi.org/10.1111/j.1600-0889.2008.00397.x>, 2009.
- Schmid, O., Artaxo, P., Arnott, W. P., Chand, D., Gatti, L. V., Frank, G. P., Hoffer, A., Schnaiter, M., and Andreae, M. O.: Spectral light absorption by ambient aerosols influenced by biomass burning in the Amazon Basin. I: Comparison and field calibration of absorption measurement techniques, *Atmos. Chem. Phys.*, 6, 3443–3462, <https://doi.org/10.5194/acp-6-3443-2006>, 2006.
- Segura, S., Estellés, V., Titos, G., Lyamani, H., Utrillas, M. P., Zotter, P., Prévôt, A. S. H., Mocnik, G., Alados-Arboledas, L., and Martínez-Lozano, J. A.: Determination and analysis of in situ spectral aerosol optical properties by a multi-instrumental approach, *Atmos. Meas. Tech.*, 7, 2373–2387, <https://doi.org/10.5194/amt-7-2373-2014>, 2014.
- Sherman, J. P., Sheridan, P. J., Ogren, J. A., Andrews, E., Hageman, D., Schmeisser, L., Jefferson, A., and Sharma, S.: A multi-year study of lower tropospheric aerosol variability and systematic relationships from four North American regions, *Atmos. Chem. Phys.*, 15, 12487–12517, <https://doi.org/10.5194/acp-15-12487-2015>, 2015.
- Slingo, A., Ackerman, T. P., Allan, R. P., Kassianov, E. I., McFarlane, S. A., Robinson, G. J., Barnard, J. C., Miller, M. A., Harries, J. E., Russell, J. E., and Dewitte, S.: Observations of the impact of a major Saharan dust storm on the atmospheric radiation balance, *Geophys. Res. Lett.*, 33, L24817, <https://doi.org/10.1029/2006GL027869>, 2006.
- Sokolik, I. and Toon, O.: Incorporation of mineralogical composition into models of the radiative properties of mineral aerosol from UV to IR wavelengths, *J. Geophys. Res.*, 104, 9423–9444, 1999.
- Solmon, F., Mallet, M., Elguindi, N., Giorgi, F., Zakey, A., and Konaré, A.: Dust aerosol impact on regional precipitation over western Africa, mechanisms and sensitivity to absorption properties, *Geophys. Res. Lett.*, 35, L24705, <https://doi.org/10.1029/2008GL035900>, 2008.
- Toon, O. B., Pollack, J. B., and Khare, B. N.: The Optical Constants of Several Atmospheric Aerosol Species: Ammonium Sulfate, Aluminum Oxide, and Sodium Chloride, *J. Geophys. Res.*, 81, 5733–5748, 1976.
- Utry, N., Ajtai, T., Pintér, M., Tombácz, E., Illés, E., Bozóki, Z., and Szabó, G.: Mass-specific optical absorption coefficients and imaginary part of the complex refractive indices of mineral dust components measured by a multi-wavelength photoacoustic spectrometer, *Atmos. Meas. Tech.*, 8, 401–410, <https://doi.org/10.5194/amt-8-401-2015>, 2015.
- Utry, N., Ajtai, T., Pintér, M., Illés, E., Tombácz, E., Szabó, G., and Bozóki, Z.: Generation and UV-VIS-NIR spectral responses of organo-mineral aerosol for modelling soil derived dust, *Atmos. Environ.*, 152, 553–561, 2017.
- Virkkula, A., Makela, T., Hillamo, R., Yli-Tuomi, T., Hirsikko, A., Hameri, K., and Koponen, I. K.: A simple procedure for correcting loading effects of aethalometer data, *J. Air Waste Manage.*, 57, 1214–1222, 2007.
- von der Weiden, S.-L., Drewnick, F., and Borrmann, S.: Particle Loss Calculator – a new software tool for the assessment of the performance of aerosol inlet systems, *Atmos. Meas. Tech.*, 2, 479–494, <https://doi.org/10.5194/amt-2-479-2009>, 2009.
- Weingartner, E., Saathof, H., Schnaiter, M., Streit, N., Bitnar, B., and Baltensperger, U.: Absorption of light by soot particles: Determination of the absorption coefficient by means of Aethalometers, *J. Aerosol Sci.*, 34, 1445–1463, 2003.
- Yoshioka, M., Mahowald, N. M., Conley, A. J., Collins, W. D., Fillmore, D. W., Zender, C. S., and Coleman, D. B.: Impact of desert dust radiative forcing on sahel precipitation: Relative importance of dust compared to sea surface temperature variations, vegetation changes, and greenhouse gas warming, *J. Climate*, 20, 1445–1467, 2007.