



**HAL**  
open science

# An interoperability assessment approach based on criteria dependencies to support decision making in networked enterprises

Gabriel S S Leal, Wided Guédria, Hervé Panetto, Erik Proper

## ► To cite this version:

Gabriel S S Leal, Wided Guédria, Hervé Panetto, Erik Proper. An interoperability assessment approach based on criteria dependencies to support decision making in networked enterprises. 17th CIAO! Doctoral Consortium Workshop, May 2017, Antwerp, Belgium. hal-01647084

**HAL Id: hal-01647084**

**<https://hal.science/hal-01647084>**

Submitted on 24 Nov 2017

**HAL** is a multi-disciplinary open access archive for the deposit and dissemination of scientific research documents, whether they are published or not. The documents may come from teaching and research institutions in France or abroad, or from public or private research centers.

L'archive ouverte pluridisciplinaire **HAL**, est destinée au dépôt et à la diffusion de documents scientifiques de niveau recherche, publiés ou non, émanant des établissements d'enseignement et de recherche français ou étrangers, des laboratoires publics ou privés.

# An interoperability assessment approach based on criteria dependencies to support decision making in networked enterprises

Gabriel Leal<sup>1,2</sup>, Wided Guédria<sup>2</sup> (co-supervisor), Hervé Panetto<sup>1</sup> (main supervisor), Erik Proper<sup>2</sup> (co-supervisor),

<sup>1</sup> Université de Lorraine, CRAN, UMR 7039, CNRS, Boulevard des Aiguillettes B.P.70239, 54506 Vandoeuvre-lès-Nancy, France

{gabriel.da-silva-serapiao-leal, herve.panetto}@univ-lorraine.fr

<sup>2</sup> ITIS, Luxembourg Institute of Science and Technology, 5, avenue des Hauts-Fourneaux, L-4362 Esch-sur-Alzette, Luxembourg

{gabriel.leal, wided.guedria, erik.proper}@list.lu

**Abstract.** In the networked enterprise, the interoperability is seen as a requirement for ensuring the collaboration among partners. Therefore, an assessment for identifying the enterprise's strengths and weakness regarding interoperability is paramount. It involves determining the gaps between where enterprises envision themselves in the future and the enterprises' current states. Indeed, a variety of approaches were proposed in the literature. However, based on surveys, existing methods are assessing specific aspects of interoperability and focusing only on one kind of measurement. The objective of this work is, therefore, to propose a holistic assessment approach to support the interoperability development. To do so, the criteria regarding the interoperability aspects and measurements were identified and are being formalised. The enterprise systems associated with the criteria are being modelled based on Enterprise Architecture techniques. This modelling supports the identification of existing interdependencies between criteria. Finally, case studies will be used to validate the proposed approach.

**Keywords:** Interoperability; Networked Enterprise; Interoperability assessment;

## 1 Introduction

Nowadays, enterprises struggle to remain competitive in the fast changing environment in which they evolve. Socio-economic challenges such as globalization, the rise of new technologies and the increasing demand of customizable services [1] are forcing companies to adapt themselves in order to ensure their market shares. In certain cases, enterprises are shifting their boundaries and participating in the so-called Networked Enterprise (NE) [2]. Such a network can be created when (a) an enterprise settles up its business in a new environment and it seeks collaboration with existing partners, (b) when two or more business entities merge or (c) when two or more enterprises join forces to provide a service or product which they couldn't do individually. In all these cases, for ensuring the network's business performance, the partners have to collaborate. To do so, enterprises should be able to interoperate together to exchange and reuse information or functionalities of each other [3]. Thus, in such context, Interoperability (i.e. the ability to interoperate) is a requirement that any enterprise should meet [4]. Assessing this ability to interoperate is frequently the initial step toward a new collaboration development or an improvement program. An enterprise needs this kind of assessment to determine its strengths and weaknesses in terms of interoperability as well as the best capabilities that will help in reaching a target state.

In the past three decades, academics and practitioners proposed different frameworks to describe interoperability such as the IDEAS framework [5], the Framework of Enterprise Interoperability (FEI) [6], the ATHENA framework [7], the European Interoperability Framework [8], and also numerous approaches to assess and improve interoperability. So far, comparative studies have been conducted to analyse

interoperability assessment approaches [15], [16], [17], [18]. Based on the analysis' results, existing methods are assessing specific aspects of interoperability (i.e. Organisational, Technical or Conceptual) [6] and focusing only on one kind of measurement i.e. focusing on the potentiality, the compatibility or the performance measurement [6]. In the interoperability assessment domain, the potentiality measurement assesses the interoperability between a system towards its environment [6]. The compatibility measurement assesses the interoperability between two known systems [6] and the performance measurement assess the cost, delay and quality of the interoperations [6]. It is worth noting that the measurement referring to performance is out of the scope of this research because it is performed only during interoperations, meaning that it is too late to identify interoperability problems at this stage.

Taking into account the comparative analysis results [18], we argue that the application of multiple approaches may hinder the design of the *as-is* (i.e. current enterprise architecture) and *to-be* (i.e. targeted alternatives) situations of the enterprise regarding interoperability, and it might cause redundancy and confusion when assessing the same aspect using different metrics and viewpoints. Thus, the research problem addressed by this thesis can be formulated as follows *“There is a lack of an assessment approach dealing with multiple aspects of interoperability and considering the different kinds of measurements. Therefore, the dependencies of requirements related to the different measurements and aspects of interoperability are not explicitly defined. Besides, enterprises have little visibility on the impacts caused by a non-fulfilment of a requirement, and by changes for improving their interoperability.”*

The objective of this work is, therefore, to propose an assessment approach to support the interoperability development, covering multiple aspects of interoperability and considering the potentiality and compatibility measurements. We will also identify and formalise the different interoperability requirements interdependencies to support the proposed approach. We argue that knowing the interdependencies between requirements is paramount for assessing interoperability as well as for supporting decisions to conduct an improvement program.

The remainder of this paper is structured as follows: we first present the research methodology in Section 2. In Section 3 we proceed to an analysis of related work. The proposed contribution is presented in Section 4. Finally, Section 5 concludes the paper and discusses the current state of the thesis and future work.

## **2 Research Methodology**

The research methodology which this thesis follows is based on the design science research (DSR) [19], [20]. We chose this methodology as it aims at providing a valuable artefact (e.g. a model or a tool) to solve a particular problem. The DSR methodology adopts six iterative steps i.e. we may revisit previously steps based on results and feedbacks from other steps. For example, considering results of the proposed artefacts' evaluation or feedbacks from publications, we could improve the design and development of the artefact, refine the research problem, etc.

The fulfilment of the methodology steps is described in Table 1 and Fig. 1 illustrates the specific activities for this research.

**Table 1.** DRS methodology's steps fulfilment.

DSRM step	Fulfilment
<b>1-Problem identification and motivation</b>	Based on an exploratory research approach, we conducted interviews and workshops with a real NE. The questionnaire used in the interviews was semi-structured, and the questions were used to initiate discussion on identified issues. During the interviews, we discussed the network adopted strategy, their services proposals, the different relations between the network partners and existing and potential problems regarding collaborations. We conclude that NE have difficulties in assessing the interoperability among their partners, and they have little visibility on the impacts caused by changes for solving interoperability problems. Further, based on the interviews, the limitations found in the literature and the comparative analysis' results [18], we raised the research problem cited in Section 1 and the following research question: <i>"How can we assess coherently the interoperability criteria and their interdependencies, when dealing with different kinds of measurements and interoperability aspects, in the NE context?"</i>
<b>2-Definition of objectives for a solution</b>	Based on the problem identification and the research question, we aim at proposing as a solution, a holistic assessment approach based on criteria dependencies for supporting the interoperability development in a NE, and at developing a prototype tool to endorse the proposed approach.
<b>3-Design and Development</b>	Based mainly on literature review, we intend to identify the interoperability requirements (i.e. the evaluation criteria from the potentiality and compatibility measurements) for ensuring and improving interoperability and its dependencies. Further, using the formalisation process proposed in [21], we intend to formalise the identified requirements and their relations. Considering that, we intent to build the assessment approach based on a maturity model. (i.e. a framework that describes the stages through which systems should evolve [15]). After that, a prototype tool will be developed for implementing the proposed approach.
<b>4-Validation</b>	The proposed approach will be applied in three case studies based on real NE located in Luxembourg.
<b>5-Evaluation</b>	We will evaluate: (a) the research conducted by doing a critical analysis. According to Österle et al. [22], scientific research in general needs to be characterised by "abstraction", "originality", "justification", and "benefit" for distinguishing itself from the manner solutions are developed in the practitioners' community or by commercial providers. (b) The assessment approach by checking the requirements for the development of maturity models proposed by Becker et al. in [23]. (c) The prototype tool by checking the requirements for the elaboration of a maturity model tool proposed by Krivograd et al. [24].
<b>6-Communication</b>	Participation in international conferences and publications in well ranked journals. This step is useful for gathering feedback from the scientific community interested in interoperability within networked enterprises.

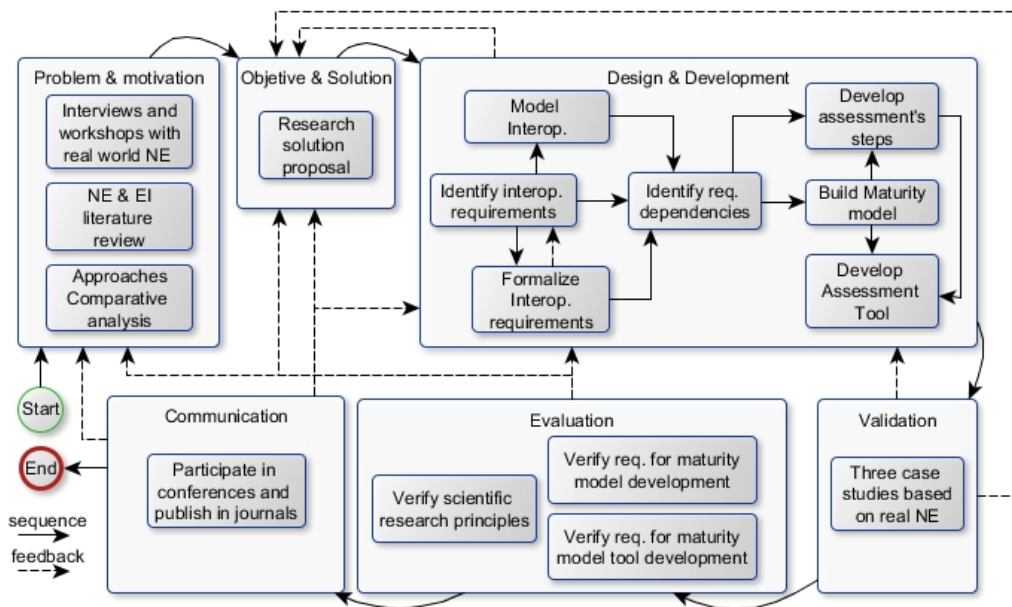

**Fig. 1.** The research method

### 3 Related Works

In this section, topics concerning this thesis' scope are brought up and discussed.

A systemic approach to addressing the interoperability is adopted in this research work. Undoubtedly, having a systemic view is paramount and widely used in Enterprise Modelling [27] because it provides a component-oriented view, which reflects closely the reality of enterprise functioning. Accordingly, we consider an enterprise as a complex system comprised of processes, people, organisations, information and communication technologies (ICT), with interdependencies and interrelationships across their boundaries [25], [26]. Taking into account these considerations, we present the different aspects of interoperability and the enterprise concerns where potential barriers can be found. Moreover, we investigate the interoperability assessment domain and existing approaches. The Enterprise Architecture (EA) [28], [29], domain is also highlighted as it is considered to provide a good steering medium to analyse the *as-is* state of the enterprise, identify and describe alternative *to-be* states, guard the coherence and alignment between the different concerns of an enterprise such as business processes and their ICT support [29]. Finally, techniques for requirements formalisation are brought forward.

#### 3.1 Enterprise Interoperability frameworks

In the past years, researchers and practitioners have proposed many frameworks for interoperability [5], [6], [7] and [8]. Among those frameworks, the FEI [6] is the only one highlighting the barriers related to the interoperability aspects. Hence, we are adopting FEI in this thesis for describing the interoperability domain.

The framework defines three dimensions which are: (1) the enterprise interoperability (EI) concerns referring to the levels of an enterprise where interoperations can take place (i.e. Business, Process, Service and Data) [6], (2) the interoperability barriers (Organisational, Technical and Organisational) which are incompatibilities that obstructs the exchange of information or functionalities between systems [6] and (3) the interoperability approaches to allow categorising knowledge and solutions relating to interoperability according to the ways of removing various barriers [6].

In this thesis, we are interested mainly in the problem space proposed by FEI which is the cross-section between the concerns and barriers dimensions. The problem space forms the twelve areas of interoperability containing the criteria (i.e. requirements) that an EI concern should meet to prevent interoperability barriers. In this work, we will adopt the term "interoperability criteria" to represent requirements composing the areas of interoperability. A limitation of FEI is the fact that it does not explicitly define the relations between the areas of interoperability.

#### 3.2 Interoperability assessment approaches

In order to support enterprises to better interoperate with their partners, the interoperability between their systems requires being assessed and continuously improved. Numerous methods have been proposed in the literature regarding interoperability assessment. Some of them are defining a maturity model such as the Levels of Information System Interoperability maturity model [9], the Organizational interoperability maturity model [10], the Levels of conceptual interoperability model [11] and the Maturity Model for Enterprise Interoperability (MMEI) [15]. Besides the maturity models, there are other approaches such as the interoperability assessment method [12], the Interoperability score [13] and the formal measures for semantic interoperability assessment [14], that are not defining levels of maturity but rather characterising the interoperability by attributing numeric or linguistics values.

Among these methods, we chose MMEI [15] as reference model because it (1) defines a common framework for assessing and measuring potential interoperability maturity, (2) covers the three aspects of

interoperability and (3) it provides ‘best practices’ that allow enterprises to improve their interoperability potential [15]. The model defines five maturity levels: Un-prepared, Defined, Aligned, Organised and Adaptive. Each maturity level is an instantiation of the main elements of an interoperability aspect with an evolution of the elements regarding the development of the level. However, MMEI cannot guarantee that enterprises having the same maturity levels can interoperate without problems (i.e. it does not provide measurements of compatibility). Also, it does not define the dependencies of the interoperability criteria within and between each maturity level.

### **3.3 Enterprise Architecture**

Regarding the interoperability assessment, we argue that the representation of the relationships among the enterprise components are essential for identifying the potential barriers in the overall system. Indeed the alignment of different levels of a company such as the business/IT [31], [32], business models and process [33], and process and data architecture [34] are crucial for enterprises performing their business. However, the different relationships between the enterprise components are not covered by the EI frameworks or assessment approaches. To tackle this limitation, we address to EA frameworks such as the Zachman framework [28] and The Open Group Architectural Framework [29] for studying the enterprise component relations.

A variety of EA modelling languages were proposed in the literature such as the Unified Enterprise Modelling Language (UEML) [35], the Design & Engineering Methodology for Organizations (DEMO) [36], the Business process model and notation (BPMN) [37] and ArchiMate [38]. Compared to other EA languages, ArchiMate is successfully used and applied in many industries and easy to understand and learn [30]. Thus, we propose in this thesis to adopt ArchiMate as it offers an architectural approach that describes and visualises the different architecture domains and their underlying relations and dependencies [38]. ArchiMate defines three layers of an EA which are the Business, the Application and Technology layers; and two extensions which are the Motivation and Implementation extensions to support the EA steering [38].

### **3.4 Requirements formalisation**

In general, natural languages (e.g. English or Portuguese) are usually used for writing requirements, either because requirement engineers do not know formal languages, or because it is too early to use such a specification structure [21]. Requirements written in natural language can cause ambiguities, misinterpretation and they cannot serve as inputs for automated verification techniques [21]. To cope with this issues, numerous methods have been developed over the years to model and formalise requirements and their relationships. For example, the formal framework for the formalisation of informal requirements [21], the Goal-oriented Requirement Language (GRL) [39] and the techniques for writing and verifying interoperability requirements proposed in [40].

To address the interoperability criteria formalisation, we adopt the methodology proposed by Peres et al. [21]. The formalisation process follows a top-down approach: it starts from the high-level requirements (i.e. requirements directly taken from the requirements’ document) and ends with directly formalised requirements. We do not describe the process entirely because of space constraints. Thus, please refer to [21] for a more detailed view of the formalisation process.

## 4 Proposed contribution

In this section, we present the proposition of a new interoperability assessment approach. It will be defined based on the interoperability criteria interdependencies. Hence, the hypothesis that we are considering in this proposal is: *There are interdependencies between interoperability criteria.*

The following sections describe the design and development, validation and evaluation of our proposal.



### 4.1 Design and Development

Two preliminary works were conducted regarding the NE and EI relations, as well as the current EI assessments approaches. The first allowed us to model the existing relationships between the concepts from the NE and EI domains. The results were published in [41] as the Networked Enterprise Meta-Model, where we stated that to be part of an NE and perform an effective collaboration, enterprises should meet requirements regarding interoperability. The Meta-Model was evaluated using a case study based on a real NE.

Afterwards, we conducted a comparative analysis considering the main approaches. The evaluation criteria and the complete results can be found in [18]. Our main finding from this analysis is that MMEI is the only model that sufficiently covers the three aspects of interoperability. Although, it performs only the EI measurement when the partner is unknown, and it does not explicitly define the interoperability criteria dependencies.

Further, for representing the different relations between enterprise components that are relevant for the interoperability assessment, we first map the MMEI objects of evaluation (e.g. Business Models, Organisational structure and storage devices) [15] using the ArchiMate notation [30] as depicted in Table 2. Concepts such as “Actor”, “Goal”, “Requirement”, “Interface”, and “Function” were also mapped, but they are not represented in this paper because of space restriction.

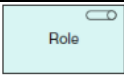
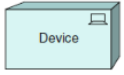
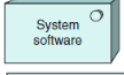
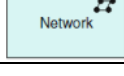
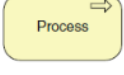
**Table 2.** MMEI and ArchiMate concepts mapping.

MMEI concept	ArchiMate concept	Notation
<b>Role:</b> A set of responsibilities, Activities and authorities granted to a person or team. One person or team may have multiple Roles	<b>Business role:</b> the responsibility for performing specific behaviour, to which an actor can be assigned	
<b>IT Infrastructure:</b> All of the hardware, software, networks, etc. that are required to Develop, Test, deliver, Monitor, Control or support IT Services. The term IT Infrastructure includes all of the ICT but not the associated people, processes and documentation	<b>Device:</b> a hardware resource upon which artefacts may be deployed for execution	
	<b>System software:</b> a software environment for specific types of components and objects that are deployed on it.	
	<b>Network:</b> a communication medium between two or more devices	
<b>Business Process:</b> A Business Process contributes to the delivery of a product or Service to a Business Customer. Many Business Processes rely on IT Services.	<b>Business Process:</b> A behaviour that groups behaviour based on an ordering of activities. It is intended to produce a defined set of products and services.	
<b>IT Service:</b> is not directly used by the Business, but is required by the IT Service Provider so they can provide other IT Services.	<b>Infrastructure service:</b> provided by one or more nodes, exposed through well-defined interfaces, and meaningful to the environment	

Based on this mapping, we design the areas of interoperability and their relationships. The identified components' relations will serve as the basis for identifying the criteria interdependencies. The relations used are those already defined in ArchiMate. A summary of the adopted relations notation is illustrated in Table 3. More details about the relations' semantics can be found in [30] and [38].

**Table 3.** ArchiMate relations

Relation	Association	Access	Uses	Realises	Specialises	Assignment	Composition
Notation	—	.....>	→	-▷	▷	↔	◆

In this paper, we present only the modelling of the business-organisational (BO) area. Based on the criteria defined by MMEI, the purpose of the BO is to ensure that the organisational structure is defined, put in place, flexible and agile [42]. It is also concerned with ensuring that human resources are trained for performing interoperations. It means that the organisational structure including the different entities and their relations are the object of evaluation when considering the interoperability assessment. In the case of a NE, the members of the network are also seen as business entities. Fig. 2 illustrates the BO area modelling.

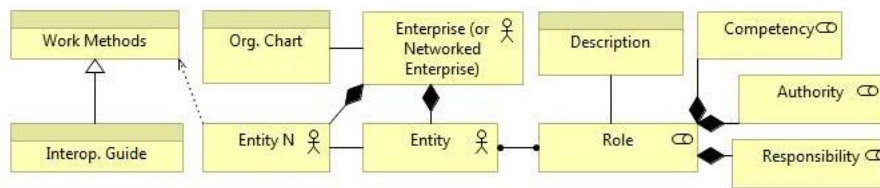

**Fig. 2.** The Business-Organisational area modelling.

In Fig. 2, the enterprise, NE and their different entities are represented by the “Actor” notation. The “Business Object” notation is used to illustrate the organisational chart, the job descriptions, the work methods and the interoperability guidelines. Roles, responsibilities, authorities and competencies are represented by the “Business Role” notation. Regarding the relations between components, we assert that the Business Role is *composed by* Responsibility, Authority and Competency. A Business Role is *associated with* a Job description and it is *assigned to* an Actor (i.e. entities). An enterprise/NE is *composed of* Actors and represented by an *associated* Organisational Chart. For dealing with interoperability issues, Actors can *access* work methods and interoperability guidelines (which are *specialisations of* work methods).

Afterwards, we move for the criteria formalisation using the methodology proposed in [21]. The adopted criteria are those defined based on the MMEI best practices. A list containing the criteria for each area of interoperability and each maturity level can be found in [42]. So far, we have formalised the twelve criteria from the first maturity level and their fifty-nine atomic criterion (i.e. a criterion which cannot be broken down into smaller criteria). The formal language used in this study is a combination of suitable temporal connectors from the CTL\* (Computer Tree Logic) [44] and the usual logical connectors from the first-order logic [45]. For respecting the space constraints, Fig. 3 illustrates only the formalisation steps of the PO1 criterion i.e. the high-level criterion refinement to the formalisation of its atomic criteria. Table 4 describes the main concepts and symbols that we are adopting to formalise the PO1 criteria.

**Table 4.** Formal language symbols.

Type	Symbol	Semantics
Term	e.g. PO1.2	It is a binary variable
Formula	F[]	An expression which is a sentence or which contains variables and becomes a sentence upon appropriate substitutions for these variables
Connectors	U	“until” Let consider A and B as requirements of a system. Then, AUB means that A has to hold (i.e. be valid) at least until at some position B holds.
	ω	“weak until” Let consider A and B as requirements of a system. Then, AωB means that A has to hold until B holds. The difference with U is that there is no guarantee that B will ever be verified.



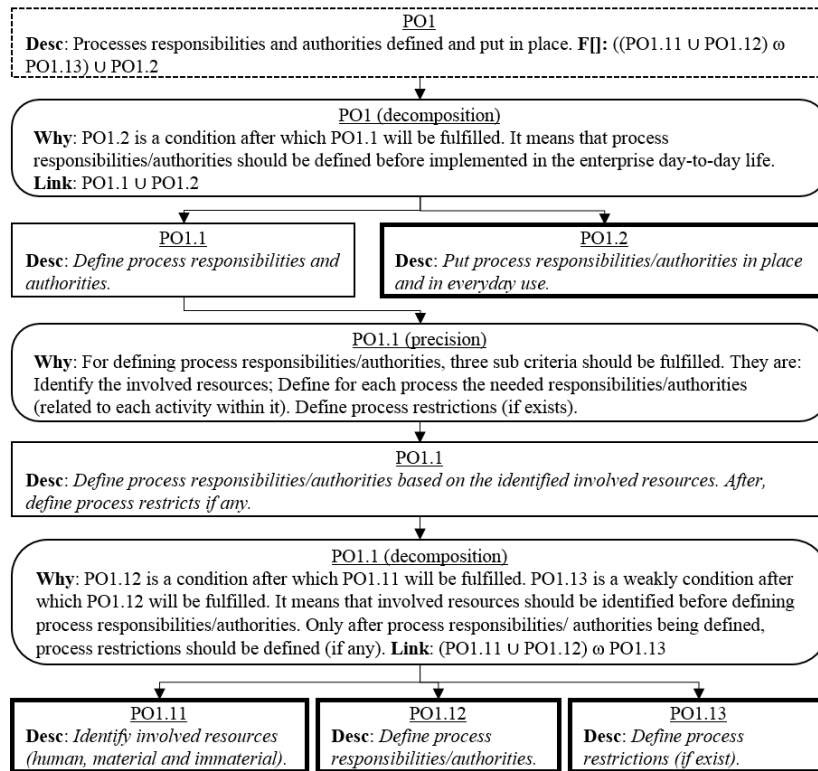

**Fig. 3.** Formalisation of the PO1 criterion

In Fig. 3, the dashed square represents the Interoperability Criterion extracted directly from the document of reference [42]. It contains its identification (i.e. PO1) and its description. The rounded rectangles represent the types of refinement (Abstractions, Decomposition, Precision or Correction) [21] and contain the “Why” property (which it explains why the refinement is helpful) [21]. The ordinary squares represent the results of the criterion refinement. And finally, the squares with thick lines represents the atomic criteria. Both ordinary and tick lined squares contain the criteria/atomic criteria descriptions. Having the criteria formalised, we can identify the same terms that are used by different formulas or even formulas that are used by different criteria. Therefore, combining the enterprise components relations and the criteria similarities, we can define the dependencies of the interoperability criteria.

Further in [45], we proposed ten general steps, as depicted in Fig.4, to be used in our assessment approach. The first step (S1) concerns with the definition of the purpose, application context and the interoperability aspects to be assessed. It is followed by the data gathering (S2) regarding the defined assessment scope. Having these steps validated, we move forward to the enterprise *as-is* design (S3) and assessment (S4). Regarding the interoperability assessment, a first evaluation is performed to evaluate the individual maturity of the enterprises within the network. It is done based on the current version of MMEI [15]. Further, an assessment comparing the interoperability criteria fulfilment of two particular enterprises is done i.e. the compatibility measurement. As mentioned before, the current version of MMEI was not proposed for this kind of measurement. To tackle this limitation, we intend to extend MMEI for the compatibility assessment context. We argue that it is possible as MMEI is based on a systemic approach. The compatibility assessment will be done by checking if the criterion fulfilled individually during the potential evaluation, is met in the same or similar way by the enterprises. The process for criterion checking based on the criteria interdependencies is still under development, and the information concerning the

incompatibilities will be extracted from knowledge stored using an ontology based on the Ontology of Enterprise Interoperability (OoEI) [46]. With this assessment, we do not intend to give a precise percentage of the compatibility of standards, data formats, etc. but rather highlights the potential EI barriers. After step four is completed, a report is generated (S5). The next step will be the design of the NE future situation (S6) for reducing the negatives impacts from the identified EI barriers. Once the *to-be* situation is defined and modelled, a gap analysis (S7) can be performed to determine the possible transformations to achieve the target state. Further, a report is generated (S8) with the gap analysis results and recommendations. Based on this report, decision-makers should prioritise the identified recommendations (S9) and define an action plan (S10). The prototype which we intend to develop will support the approach, mainly in the data gathering (S2), *as-is* assessment (S4) and the gap analysis (S7) steps.

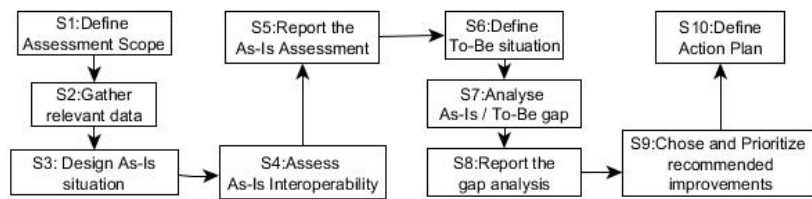

Fig. 4. The assessment process

## 4.2 Validation

As part of the research methodology, this section illustrates a real case study based on an active NE in the field of marketing and communication in Luxembourg. First, we describe a business scenario and the NE perceived problems. Further, we design the NE using EA components considering the EI relevant concepts. The MMEI assessment of two enterprises from the network is briefly presented. The information used to define the scenario were gathered through interviews and analysis of provided documents by the enterprises. The selected interviewees are members of the board of directors of each enterprise. The name of the network and its members as well as the identity of the customer remains classified for security reasons. Thus, we will refer to them as “*TheNetwork*”, “*EntA*”, “*EntB*” and “*Customer*”.

**Scenario description.** In general, entrepreneurs do not know what the steps to follow for developing their brand image are. They turn to business development and marketing agencies such as *TheNetwork*. Hence, the *Customer* objectives are to request information concerning what is required to develop their business image and to request the agencies to handle all the development process. To offer any combination of the network’s services, *TheNetwork* promises a single point of contact for their customers. It implies that one of the members assumes the role of mediator between the *Customer* and the rest of the network. In this scenario, *EntA* supposed to be the mediator. However, it is not what happened in reality. *EntA* does not fulfil its role as mediator. It means that after contacting the *Customer*, *EntA* requests *EntB* their services and put *EntB* in direct contact with the client. *EntB* keeps touch with the *Customer* until the delivery of their services. The perceived problems in this configuration are (a) that information is not centralised, (b) the members do not have a “one voice” when handling customer relationships, and (c) participants faced information exchange barriers such as lack of linguistics skills and documents in different formats.

**Modelling TheNetwork.** Fig. 5 illustrates the part of *TheNetwork* model which represents the components involved in the Client information exchange. For instance, project manager from *EntA* sends an email to a project manager from *EntB* containing the Client File (which is all documents containing key data from the client). This view can help us to identify the component that may be the source of the EI barriers.

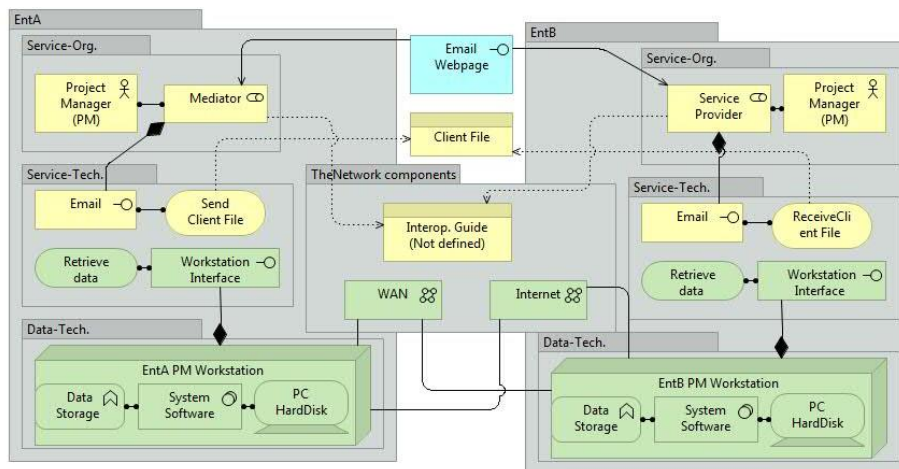

**Fig. 5.** TheNetwork model – Client File exchange representation.

**Assessing TheNetwork interoperability.** Here, we assessed the interoperability maturity of *EntA* and *EntB* applying the assessment methodology described in [15]. Both enterprises had scored a global maturity level equal to 0 which means that companies do not have an appropriate environment for developing and maintaining interoperability. It is important to note that a lower interoperability maturity for a company does not systematically mean a dysfunction at all levels and for all functions of the enterprise. The maturity is only evaluated from the interoperability point of view and cannot be applied for another purpose. Based on the assessment, we identified some EI potential barriers which are: (a) the syntax incompatibilities i.e. heterogeneous formats to describe and represent the Client File. (b) The semantics incompatibilities of the exchanged information as the enterprises use multiple languages (e.g. English, German and French) and the fact that for both enterprises it holds that not all employees have the needed linguistic skills. (c) The differences in the respective companies' goals and (d) that collaboration rules are not defined (i.e. no interoperability guide is defined).

**Recommendations.** It is worth noting that with the current state of this thesis, we are not yet able to plan interoperability transformation, but we can recommend some actions for improving the NE interoperability based on the assessment results and the best practices proposed in MMEI. Thus, *TheNetwork* could take the following actions: (a) Formalise and document information related to collaborative business processes; (b) Standardise administrative documents (e.g. client files, contracts, etc.); (c) Share the employees' Job description to allow employees identify who does what within the group; and (d) Implement an integrated project management tool.

### 4.3 Evaluation

In this section, we evaluate the thesis proposal.

**Critical analysis.** The thesis's fulfilment of the Österle et al. [22] principles are the following: *Abstraction* – The thesis proposes a holistic interoperability assessment approach based on the interoperability criteria formalisation and their relations; *Originality* – There is no explicit representation of interoperability criteria interdependencies in the literature; *Justification* – The literature limitations mentioned in Section 3 justify the proposed contribution; *Benefit* – Knowing the relations between interoperability criteria, helps enterprises to decide and plan EI improvements.

**Requirement for maturity model development.** The proposed artefact fulfilment of Becker et al. in [23] requirements are the following: *R1) Comparison with existing maturity models* – Published in [19]; *R2) Iterative Procedure* – the relations between requirements and the compatibility measures are done iteratively, starting from literature reviews followed by group discussion. Case studies will also be used to identify missing relations; *R3) Evaluation* - Fulfilment of the Becker et al. requirements and qualitative feedback from practitioners. *R4) Multi-methodological Procedure* – Literature review, exploratory research and case study; *R5) Identification of problem relevance* – The use of different approaches for covering all aspects of interoperability may hinder the *as-is* and *to-be* design and the maturity determination as they use different metrics and viewpoints. *R6) Problem definition* – Cited in Section 1; *R7) Target Presentation of results* - Scientific community and practitioners who have the need to assess enterprise interoperability; *R8) Scientific documentation* – Covered by the DSR methodology Communication step.

**Requirements for developing a maturity model tool.** The prototype tool is under development. However, we intend to meet the requirements for the development of a generic tool for the application of maturity models as proposed by [24]. They are divided into two types: Functional (e.g. Connectivity and Compare assessments) and Non-Functional (e.g. ease to use, and assistance function) requirements.

## 5 Conclusion

Enterprises within NE have difficulties in identifying existing and potential interoperability barriers that may impact negatively their business. Hence, the primary objective of this research is to propose an approach for assessing the interoperability within a network of enterprises and for providing improvements guidance. We also aim at identifying and formalising the interdependencies between the interoperability criteria as we argue that knowing these interdependencies is essential for supporting a comprehensive assessment. To do so, we propose to design the objects of evaluation (e.g. business process models, data storage devices, etc.) defined by MMEI using the ArchiMate modelling language. It gives an overall view of the enterprise components and their relations regarding interoperability. Further, we intend to formalise the interoperability criteria extracted from the MMEI and the literature for strengthening the identified criteria relationships. The criteria relationships will be used to enrich the current version of MMEI. In addition, a prototype tool is being developed to endorse the proposed assessment approach. Following the research methodology, we illustrate the approach using a real scenario provided by a real NE. Preliminary evaluations of our contribution were made and presented in Section 4.

As future work, we intend to (i) finish the interoperability requirements formalisation; (ii) use the Analytical Network Process [47] for representing through its super matrix, the outcome of interoperability criteria dependencies within and between maturity levels; (iii) extend the MMEI to cover the compatibility measures; and finally, (iv) finalise the prototype tool architecture development.

**Acknowledgments.** This work has been conducted in the context of the PLATINE project (PLanning Transformation Interoperability in Networked Enterprises), financed by the Luxembourg National Research Fund (FNR), under the grant C14/IS/8329172.

## References

1. Proper, H.A.: Enterprise architecture: informed steering of enterprises in motion. In: 15th International Conference on Enterprise Information Systems. pp. 16-34. Springer International Publishing (2013)
2. Camarinha-Matos, L. M., Afsarmanesh, H., Galeano, N., Molina, A.: Collaborative Networked Organizations – Concepts and Practice in Manufacturing Enterprises. *Computers & Industrial Engineering Internat. Journal* 57.1, 46-60 (2009).

3. Vernadat, F.B. Interoperable enterprise systems: Principles, concepts, and methods. In *Annual Reviews in Control*, 31, 137-145. (2007)
4. Mallek, S., Daclin, N., Chapurlat, V.: The application of interoperability requirement specification and verification to collaborative processes. *Computers in industry*, 63.7, 643-658 (2012)
5. IDEAS 2003 - IDEAS Project Deliverables (WP1-WP7), Public Reports (2003)
6. David Chen, Michele Dassisti, Brian Elvesaeter, Hervé Panetto, Nicolas Daclin, Frank-Walter Jaekel, et al.: Deliverable DI.2, INTEROP NoE (Network of Excellence) (2006)
7. ATHENA: Specification of interoperability framework and profiles, guidelines and best practices. ATHENA public Deliverable D. A.4 (2007)
8. European Commission: Annexe on the Communication from the Commission to the European Parliament, the Council, the European Economic and Social Committee and the Committee of Regions 'Towards interoperability for European public services. (2010)
9. Department of Defense: Levels of Information System Interoperability (LISI). C4ISR Architecture Working Group Final Report - Washington DC (1998)
10. Clark, T., Jones, R.: Organizational interoperability maturity model for c2. In: *Proc. of the Command and Control Research and Technology Symposium*, Washington (1999)
11. Tolk, A., Muguira, J.A.: The levels of conceptual interoperability model. In *Fall Simulation Interoperability Workshop*, USA (2003)
12. Leite, M.: Interoperability Assessment. In: *Proceedings of the 66th MORS Symposium*, Naval Postgraduate School, Monterey, CA, 23-25 (1998)
13. Ford, T., Colombi, J., Graham, J., Jacques, D.: The Interoperability Score. In: *Proceedings of the 5th Annual Conference on Systems Engineering Research*. Hoboken, N.J. (2007)
14. Yahia, E., Aubry, A., Panetto, H.: Formal measures for semantic interoperability assessment in cooperative enterprise information systems. *Computers in Industry* 63.5,443-457 (2012)
15. Guédria, W., Naudet, Y. Chen, D.: Maturity model for enterprise interoperability. *Enterprise Information Systems* 9.1, 1-18 (2013)
16. Panetto, H.: Towards a Classification Framework for Interoperability of Enterprise Applications. *International Journal of Computer Integrated Manufacturing*, Taylor & Francis, 20.8, 727-740 (2007)
17. Ford, T.C.: Interoperability measurement, Ph.D. thesis, Department of the Air Force Air University, Air Force Institute of Technology (2008)
18. Leal, G., Guédria, W., Panetto, H., Lezoche, M.: Towards a comparative analysis of interoperability assessment approaches for collaborative enterprise systems. In *23rd International Conference on Transdisciplinary Engineering*, 45-54, IOS Press (2016)
19. Hevner, A., March, S. Park J., Ram. S.: Design Science in Information Systems Research. *MIS Quarterly*, 28.1, 75-105 (2004)
20. Peffers, K., Tuunanen, T., Rothenberger, M.A. Chatterjee. S.: A Design Science Research Methodology for Information Systems Research. *Journal of Management Information Systems*, 24.3, 45-78 (2008)
21. Peres, F., Yang, J. and Ghazel, M.: A formal framework for the formalization of informal requirements. In *International Journal of Soft Computing and Software Engineering*, 2.8, 14-27 (2012)
22. Österle, H., Becker, J., Frank, U., Hess, T., Karagiannis, D., Krcmar, H., Loos, P., Mertens, P., Oberweis, A. and Sinz, E.J.: Memorandum on design-oriented information systems research. *European Journal of Information Systems*, 20.1, 7-10. (2001)
23. Becker, J., Knackstedt, R., Pöppelbuß, P.: Developing Maturity Models for IT Management - A Procedure Model and its Application. *Business & Information Systems Engineering* 1.3, 213-222 (2009)
24. Krivograd, N., Fettke, P. and Loos, P.: Development of an Intelligent Maturity Model-Tool for Business Process Management. In *47th Hawaii International Conference of Systems Science*, 3878-3887. IEEE. (2014)
25. Nightingale, D.: Principles of enterprise systems. In *Second International Symposium on Engineering Systems*, Cambridge, Massachusetts, USA. MIT (2009)
26. Giachetti, R.E.: *Design of Enterprise Systems: Theory, Architecture, and Methods*. CRC Press Inc; Édition1, (2010)
27. Vernadat, F.: Enterprise Modeling in the context of Enterprise Engineering: State of the art and outlook. *Int. Journal of Production Management and Engineering*, 2.2, 57-73. (2014)
28. Zachman, J. A.: A Framework for Information Systems Architecture. *IBM Systems Journal*, 26.3, (1987)
29. The Open Group Architectural Framework (TOGAF) Version 9.1. The Open Group, Reading, UK. <http://www.opengroup.org/togaf/>.
30. Lankhorst, M.M.: *Enterprise Architecture at Work - Modelling, Communication and Analysis*, 4th edn. The Enterprise Engineering Series. Springer (2013)

31. Henderson, J.C. and Venkatraman, N.: Strategic alignment: a model for organizational transformation through information technology. *Transforming organizations*, 97-117 (1992)
32. Goepf, V. and Avila, O.: An Extended-Strategic Alignment Model for technical information system alignment. *International Journal of Computer Integrated Manufacturing*, 28.12, 1275-1290 (2015)
33. Solaimani, S. and Bouwman, H.: A framework for the alignment of business model and business processes: A generic model for trans-sector innovation. *Business Process Management Journal*, 18.4, 655-679. (2012)
34. Castellanos, C. and Correal, D.: A framework for alignment of data and processes architectures applied in a government institution. *Journal on Data Semantics*, 2, 61-74 (2013)
35. Panetto, H., Berio, G., Benali, K., Boudjlida, N. and Petit, M.: A unified enterprise modelling language for enhanced interoperability of enterprise models. In 11th IFAC INCOM2004 Symposium, pp. 1-12). Elsevier. (2004)
36. Dietz, J.L.G., *Enterprise Ontology – theory and methodology*, Springer-Verlag Heidelberg, Berlin, New York (2006)
37. OMG, Business process model and notation (BPMN 2.0), formal/2011-01-03, OMG. <http://www.omg.org/spec/BPMN/2.0>
38. The Open Group, ArchiMate® 2.1 Specification. Available: <http://pubs.opengroup.org/architecture/archimate2-doc/>.
39. Giorgini P, Mylopoulos J, Sebastini R. Goal-oriented requirements analysis and reasoning in the Tropos methodology. *Engineering Applications of Artificial Intelligence* 18.2, 159–171 (2005)
40. Daclin, N., Daclin, S.M., Chapurlat, V. and Vallespir, B.: Writing and verifying interoperability requirements: Application to collaborative processes. *Computers in Industry*, 82, 1-18. (2016)
41. Leal, G., Guédria, W., Panetto, H., Proper E.: Towards a Meta-Model for Networked Enterprise. In 21st EMMSAD, Slovenia. In LNBP 248, 417-431. Springer, (2016)
42. Guédria, W., 2012. A contribution to enterprise interoperability maturity assessment (Doctoral dissertation, Bordeaux 1).
43. Emerson, E.A. and Halpern, J.Y.: “Sometimes” and “not never” revisited: on branching versus linear time temporal logic. *Journal of the ACM*, 33(1), pp.151-178. (1986)
44. Nienhuys-Cheng, S.H. and De Wolf, R.: *Foundations of inductive logic programming* (Vol. 1228). Springer Science & Business Media. (1997)
45. Leal, G. Guédria, W., Panetto, H. Proper E.: An approach for interoperability assessment in networked enterprise. In the 20th IFAC WC to be held in Toulouse, France, July 2017
46. Naudet, Y., Latour, T., Guedria, W., Chen D.: Towards a systemic formalisation of interoperability. *Computers in Industry*, 61.2, 176–185. (2009)
47. Saaty, T.L.: Fundamentals of the Analytical Network Process, in: *ISAHP* 12–14 (1999)