



HAL
open science

Consistent formulation for the Discrete-Continuous Model: Improving complex dislocation dynamics simulations

O. Jamond, R. Gatti, Arjen Roos, Benoit Devincere

► **To cite this version:**

O. Jamond, R. Gatti, Arjen Roos, Benoit Devincere. Consistent formulation for the Discrete-Continuous Model: Improving complex dislocation dynamics simulations. *International Journal of Plasticity*, 2016, 80, pp.19 - 37. 10.1016/j.ijplas.2015.12.011 . hal-01637572

HAL Id: hal-01637572

<https://hal.science/hal-01637572>

Submitted on 22 Jan 2018

HAL is a multi-disciplinary open access archive for the deposit and dissemination of scientific research documents, whether they are published or not. The documents may come from teaching and research institutions in France or abroad, or from public or private research centers.

L'archive ouverte pluridisciplinaire **HAL**, est destinée au dépôt et à la diffusion de documents scientifiques de niveau recherche, publiés ou non, émanant des établissements d'enseignement et de recherche français ou étrangers, des laboratoires publics ou privés.

1
2
3
4
5
6
7
8
9
10
11
12
13
14
15
16
17
18
19
20
21
22

Consistent formulation for the Discrete-Continuous Model: improving complex Dislocation Dynamics simulations

O. Jamond^{a,b,*}, R. Gatti^a, A. Roos^{b,**}, B. Devincré^a

^a*LEM, UMR104 CNRS-ONERA, 29 Avenue de la Division F-92322 Châtillon, France.*

^b*ONERA – The French Aerospace Lab, France.*

Abstract

23
24
25
26
27
28
29
30
31
32
33
34
35
36
37
38
39
40
41
42
43
44
45
46
47
48
49
50
51
52
53

A new and efficient formulation of the Discrete-Continuous Model (DCM) for the simulation of 3D dislocation dynamics in complex finite or periodic volumes is presented. As in previous versions, the improved model is based on a coupling between a Dislocation Dynamics (DD) code and a Finite Element (FE) code through eigenstrain theory. Short-range interactions are now handled more properly. Specifically, in the continuous limit the stress field driving the dislocation dynamics is now reconstructed consistently. Furthermore, the DCM can now handle nonstructured meshes, and free surface and interface handling does not depend on having a structured mesh anymore. Also numerical experiments shed some light on the influence of the choice of the FE quadrature. Some approximations are proposed and justified, and the use of advanced algorithmic techniques are used for time integration and the homogenisation procedure to reach a high computational efficiency. Basic tests demonstrate the validity and the efficiency of the proposed strategy. Remarkably, it is demonstrated that for a periodic domain the

54
55
56
57
58

*Corresponding author: olivier.jamond@cea.fr. Present address: CEA – Paris Saclay, France.

**Present address: Safran Tech – Paris Saclay, France.

1
2
3
4
5
6
7
8
9 DCM with a very fine FE mesh is actually faster than a corresponding classical
10 DD simulation.

11
12 *Keywords:* Dislocation dynamics, Finite element, Dislocation theory, Crystal
13 plasticity, Micromechanics
14
15

16 17 18 **1. Introduction** 19

20
21 Three-dimensional Dislocation Dynamics (DD) simulation has become an essen-
22 tial tool in materials science during the last few years because of the many inves-
23 tigation into the mechanical properties of micro- and nano-objects and because
24 of the need for more physically justified crystal plasticity constitutive rules. In
25 its most standard formulations, DD simulations use analytical expressions for the
26 stress field of dislocation segments which are part of discretised dislocation loops.
27 However those expressions are valid only for isotropic elasticity and in an infinite
28 continuum [1–3]. In order to handle more complex boundary conditions and to
29 take the effects of free surfaces or internal boundaries into account, alternative nu-
30 merical solutions have also been developed (see for instance [4] for a description
31 and comparison of the main methods). In the following such solutions are called
32 hybrid methods, as opposed to classical methods defined in infinite domains.
33
34

35
36
37
38
39
40
41
42
43
44 Most of the hybrid methods depend on a coupling between DD and Finite
45 Elements (FE). The most widely used approach is the superposition method in
46 which the mechanical problem is decomposed into a DD problem in an infinite
47 medium and a dislocation-free complementary boundary value problem, solved
48 by a FE elastic solver [5–10]. The Peach-Köhler forces driving the dislocation
49 dynamics are then calculated, at line segments, from the stress obtained by adding
50 the stress from the dislocation-free complementary FE problem to the analytical
51
52
53
54
55
56
57
58
59
60
61
62
63
64
65

1
2
3
4
5
6
7
8
9 stress as calculated in the standard DD simulation in an infinite medium, so that
10 the boundary conditions are taken into account properly. This approach was ex-
11 tensively used and optimised in the past years to simulate mainly plasticity of
12 micro- and nano-objects (see for instance [11–18]).

13
14
15
16 An alternative hybrid approach is the Discrete-Continuous Model (DCM) [19–
17 23]. Here only the short-range dislocation-dislocation interactions are treated an-
18 alytically and all other interactions including those due to external loads and free
19 boundaries are calculated numerically by FE. Mixed calculations in which the
20 DD responses in one set of regions are combined with phenomenological con-
21 stitutive laws in other regions of the structure then become almost trivial. The
22 DCM is based on a regularisation of the atomic displacement jump across the slip
23 plane into a plastic strain inclusion following the eigenstrain theory [24]. It was
24 successfully applied to several practical problems, such as anisotropic thin films
25 [25, 26], metal-matrix composites with long fibres [27], micro-pillars [21] and
26 single-crystal $\gamma - \gamma'$ Ni based superalloys [28]. Nevertheless, several limitations
27 have appeared in the past years:

- 28 • The calculations were restricted to simple geometries due to the need for
29 regular structured meshes made out of hexaedron elements.
- 30 • The procedure for regularising slip near domain boundaries was restricted
31 to and optimised for such structured meshes [22].
- 32 • Calculations of the dislocation self-stress field at distances around the bound-
33 ary of the eigenstrain volume suffered from a sharp discontinuity and there-
34 fore could be at the origin of an artificial jump in the velocity of two ap-
35 proaching dislocations [29].

- 1
2
3
4
5
6
7
8
9 • The coupling algorithm between the two codes was general and not opti-
10 mised for the DCM.
11
12

13
14 In this work, these limitations are addressed through the development of a new
15 formulation for the DCM and through numerical improvements. This new formu-
16 lation is presented in §2 and is said to be consistent because it leads to a proper
17 reconstruction of the stress field driving the DD at the continuous limit for the
18 FE problem. Next, numerical optimisations of the DCM procedures are presented
19 in §3 with some recommendations regarding the choice of the spatial integration
20 in the FE simulation part. The paper is closed with elementary tests presented
21 in §4 to show the new possibilities and performances of the DCM. Large-scale
22 computation tests with high dislocation densities and complex geometries with
23 associated performance analyses will be presented in a forthcoming paper. In the
24 following, all DCM tests use the microMegas DD simulation code [30] and the
25 Z-set FE solver [31].
26
27
28
29
30
31
32
33
34
35
36
37

38 **2. The new DCM formulation**

39
40

41 In the DCM, the stress field $\boldsymbol{\sigma}$ driving the movement of the dislocations is a su-
42 perposition of a stress field $\boldsymbol{\sigma}^{FE}$ computed numerically by the FE code and a local
43 correction stress field $\boldsymbol{\sigma}^{LC}$. The latter is calculated analytically in the vicinity of
44 the dislocation lines in order to reconstruct a pseudo-singular field close to the
45 dislocation lines. The stress $\boldsymbol{\sigma}^{FE}$ transmits the long-range dislocation-dislocation
46 interactions, the body forces and the loads transmitted through the boundary con-
47 ditions. It takes into account the plastic strains $\boldsymbol{\epsilon}^p$ generated by the movement of
48 dislocations through a regularisation of the displacement jump $[[\boldsymbol{u}]]$ across the slip
49 plane. The regularisation procedure, following the eigenstrain theory [24], intro-
50
51
52
53
54
55
56
57
58

duces a homogenisation length h . The maximum element size of the FE mesh is directly related to this length in order to guarantee that sufficient integration points lie inside each eigenstrain volume. The local correction σ^{LC} is computed by the DD code, which then handles the movements of the dislocation lines and their topological contact reactions. These basic principles of the DCM are described in full detail in [22] and schematically illustrated in Fig. 1.

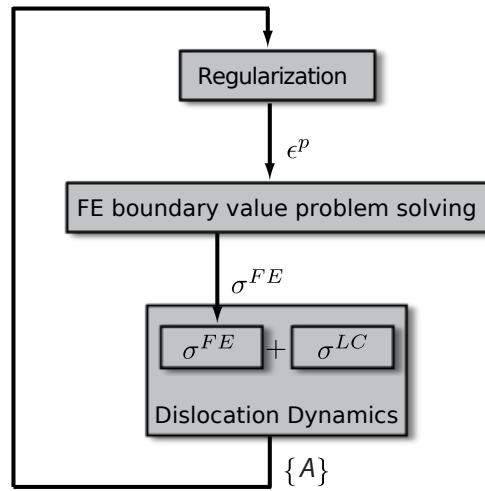

Figure 1: The basic DCM algorithm: the motion of the discrete dislocation lines is handled by the DD simulation code. For the calculation of the Peach-Köhler force, a local correction σ^{LC} is calculated internally in the DD code to account for the strong elastic interactions between close segments. The other stress contribution σ^{FE} is computed with the FE code when solving the boundary value problem and taking the eigenstrain distribution into account. The latter results from the regularisation of the accumulated slipped areas $\{A\}$.

The calculation of the local correction σ^{LC} is a key point of the DCM to reproduce correctly short-distance dislocation-dislocation interactions and contact reactions between dislocation segments. In the previous DCM formulation, σ^{LC} is simply the singular stress field σ^S as is usually used in standard DD simula-

1
2
3
4
5
6
7
8
9 tions, truncated at a distance h from the dislocation line. This simple solution is
10 precise enough to capture, for instance, the zipping/unzipping process of junctions
11 [22]. However it turns out that for small values of h (*i.e.*, < 50 nm), large numer-
12 ical errors may appear in the dislocation dynamics when dislocation lines are at
13 distances around h . This is because the superposition of the two contributions
14 generates a stress discontinuity at the contour of the eigenstrain volume, which
15 becomes significant in those cases.
16
17
18
19
20
21

22 To overcome this important limitation, a revised local correction is presented
23 in §2.1. This revised local correction is said to be *consistent* because at the con-
24 tinuous limit for the FE solution, *i.e.* at the limit when the element size tends to
25 zero, it leads to an exact reconstruction of the mechanical fields for the problem of
26 an infinite domain. The improved calculation of $\boldsymbol{\sigma}^{LC}$ also implies modifications
27 to the regularisation procedure, *i.e.* the way in which the plastic eigenstrain $\boldsymbol{\epsilon}^P$ is
28 distributed to the integration points (IP) of the FE mesh. This is presented in §2.2.
29 Then, the way in which surfaces and interfaces are handled is described in §2.3.
30
31
32
33
34
35
36
37
38

39 2.1. Consistent reconstruction of the stress field

40
41 As for the superposition method, the new DCM formulation is based on the lin-
42 earity of the problem of finding the displacement and stress fields $(\boldsymbol{u}, \boldsymbol{\sigma})$ in a finite
43 elastic domain Ω containing displacement jumps $[[\boldsymbol{u}]]$ due to dislocation glide, and
44 its decomposition into sub-problems which are easier to solve. This reference
45
46
47
48
49
50
51
52
53
54
55
56
57
58
59
60
61
62
63
64
65

boundary value problem \mathcal{P} can be written as follows:

$$\mathcal{P} \left\{ \begin{array}{ll} \nabla \cdot \boldsymbol{\sigma} + \mathbf{f} = \mathbf{0} & \text{in } \Omega \setminus \{A\} \\ \boldsymbol{\sigma} = \mathbf{E} : \boldsymbol{\varepsilon} & \text{in } \Omega \setminus \{A\} \\ [[\mathbf{u}]] & \text{across } \{A\} \\ \mathbf{u} = \mathbf{u}_0 & \text{at } \partial\Omega_u \\ \boldsymbol{\sigma} \cdot \mathbf{n} = \mathbf{t} & \text{at } \partial\Omega_\sigma. \end{array} \right. \quad (1)$$

The boundary $\partial\Omega$ of Ω with outward normal \mathbf{n} is divided into $\partial\Omega_u$ where Dirichlet boundary conditions are applied and into $\partial\Omega_\sigma$ (non-overlapping with $\partial\Omega_u$) where Neumann boundary conditions are applied. At time t , $\{A\}$ represents the area swept by the dislocation loops since the beginning of the simulation. This includes the initial Volterra process used to define the initial eigenstrain distribution associated to the initial dislocation line configuration. The displacement jump $[[\mathbf{u}]]$ is tangent to $\{A\}$, its magnitude and direction are given by the Burgers vector \mathbf{b} . Furthermore, \mathbf{E} is the fourth-order tensor of elasticity, $\boldsymbol{\varepsilon}$ the small-strain strain tensor (the symmetric part of the gradient of the displacement field), \mathbf{f} represents the body forces, \mathbf{t} the traction applied at Neumann boundaries, and \mathbf{u}_0 is the prescribed displacement at Dirichlet boundaries.

This problem \mathcal{P} can be decomposed linearly into three sub-problems

1. \mathcal{P}^{FE} with solution $(\mathbf{u}^{FE}, \boldsymbol{\sigma}^{FE})$, where the FE stands for Finite Element even though at this point the problem is not yet discretised, and even though this sub-problem might be solved by any other numerical method,
2. \mathcal{P}^S with an analytical Singular (S) solution $(\mathbf{u}^S, \boldsymbol{\sigma}^S)$, and
3. \mathcal{P}^{NS} with an analytical Non-Singular (NS) solution, written as $(\mathbf{u}^{NS}, \boldsymbol{\sigma}^{NS})$.

The three considered sub-problems are

$$\begin{array}{l|l}
 \mathcal{P}^{FE} & \begin{array}{l}
 \nabla \cdot \boldsymbol{\sigma}^{FE} + \mathbf{f} = \mathbf{0} \text{ in } \Omega \\
 \boldsymbol{\sigma}^{FE} = \mathbf{E} : (\boldsymbol{\varepsilon}^{FE} - \boldsymbol{\varepsilon}^P) \text{ in } \Omega \\
 \mathbf{u}^{FE} = \mathbf{u}_0 - (\mathbf{u}^S - \mathbf{u}^{NS}) \text{ at } \partial\Omega_u \\
 \boldsymbol{\sigma}^{FE} \cdot \mathbf{n} = \mathbf{t} - (\boldsymbol{\sigma}^S - \boldsymbol{\sigma}^{NS}) \cdot \\
 \mathbf{n} \text{ at } \partial\Omega_\sigma,
 \end{array}
 \end{array} \quad (2)$$

$$\begin{array}{l|l}
 \mathcal{P}^S & \begin{array}{l}
 \nabla \cdot \boldsymbol{\sigma}^S = \mathbf{0} \text{ in } \mathbb{R}^3 \setminus \{A\} \\
 \boldsymbol{\sigma}^S = \mathbf{E} : \boldsymbol{\varepsilon}^S \text{ in } \Omega \setminus \{A\} \\
 \llbracket \mathbf{u}^S \rrbracket \text{ across } \{A\},
 \end{array}
 \end{array} \quad (3)$$

$$\begin{array}{l|l}
 \mathcal{P}^{NS} & \begin{array}{l}
 \nabla \cdot \boldsymbol{\sigma}^{NS} = \mathbf{0} \text{ in } \mathbb{R}^3 \\
 \boldsymbol{\sigma}^{NS} = \mathbf{E} : (\boldsymbol{\varepsilon}^{NS} - \boldsymbol{\varepsilon}^P) \text{ in } \Omega.
 \end{array}
 \end{array} \quad (4)$$

With the definition

$$(\mathbf{u}, \boldsymbol{\sigma}) \equiv (\mathbf{u}^{FE}, \boldsymbol{\sigma}^{FE}) - (\mathbf{u}^{NS}, \boldsymbol{\sigma}^{NS}) + (\mathbf{u}^S, \boldsymbol{\sigma}^S) \quad (5)$$

it can be verified that

$$\mathcal{P} = \mathcal{P}^{FE} - \mathcal{P}^{NS} + \mathcal{P}^S. \quad (6)$$

The eigenstrain distribution $\boldsymbol{\varepsilon}^P$ is constructed additively over the set of dislocation loops, *i.e.*

$$\boldsymbol{\varepsilon}^P = \sum_{\ell \in L} \boldsymbol{\varepsilon}_\ell^P \quad (7)$$

where L is the set of dislocation loops. The problem \mathcal{P}^{NS} can then be decomposed into dislocation loop-wise sub-problems \mathcal{P}_ℓ^{NS} :

$$\mathcal{P}^{NS} = \sum_{\ell \in L} \mathcal{P}_\ell^{NS} \quad (8)$$

where

$$\mathcal{P}_\ell^{NS} \left| \begin{array}{ll} \nabla \cdot \boldsymbol{\sigma}_\ell^{NS} = \mathbf{0} & \text{in } \mathbb{R}^3 \\ \boldsymbol{\sigma}_\ell^{NS} = \mathbf{E} : (\boldsymbol{\varepsilon}_\ell^{NS} - \boldsymbol{\varepsilon}_\ell^p) & \text{in } \Omega. \end{array} \right. \quad (9)$$

Similarly one can write

$$\llbracket \mathbf{u}^S \rrbracket = \sum_{\ell \in L} \llbracket \mathbf{u}^S \rrbracket_\ell \quad (10)$$

and

$$\mathcal{P}^S = \sum_{\ell \in L} \mathcal{P}_\ell^S \quad (11)$$

where

$$\mathcal{P}_\ell^S \left| \begin{array}{ll} \nabla \cdot \boldsymbol{\sigma}_\ell^S = \mathbf{0} & \text{in } \mathbb{R}^3 \setminus \{A\} \\ \boldsymbol{\sigma}_\ell^S = \mathbf{E} : \boldsymbol{\varepsilon}_\ell^S & \text{in } \Omega \setminus \{A\} \\ \llbracket \mathbf{u}^S \rrbracket_\ell & \text{across } \{A\}. \end{array} \right. \quad (12)$$

The key point of this new DCM decomposition (6) is that one can choose an eigenstrain distribution such that $\boldsymbol{\sigma}_\ell^S - \boldsymbol{\sigma}_\ell^{NS}$ decreases rapidly to zero with increasing distance from the dislocation line ℓ (the actual eigenstrain distribution considered is described in §2.2). Thus, the term $\boldsymbol{\sigma}_\ell^S - \boldsymbol{\sigma}_\ell^{NS}$ can be truncated at a given distance $r = r_\ell$ from the dislocation line ℓ , and the DCM reconstruction of the total stress field then becomes

$$\boldsymbol{\sigma}^{LC} \equiv \sum_{\ell \in L} \boldsymbol{\sigma}_{\ell|r_\ell}^S - \sum_{\ell \in L} \boldsymbol{\sigma}_{\ell|r_\ell}^{NS} \quad (13)$$

$$\boldsymbol{\sigma} = \boldsymbol{\sigma}^{FE} + \boldsymbol{\sigma}^{LC}, \quad (14)$$

where $\boldsymbol{\sigma}_{\ell|r_\ell}^{NS}$ and $\boldsymbol{\sigma}_{\ell|r_\ell}^S$ are the stress fields $\boldsymbol{\sigma}_\ell^{NS}$ and $\boldsymbol{\sigma}_\ell^S$ truncated at a distance r_ℓ of the dislocation ℓ and the stress $\boldsymbol{\sigma}^{LC}$ is the new definition of the DCM local-correction term. In what follows, unless noted explicitly, the notations $\boldsymbol{\sigma}^{NS}$ and $\boldsymbol{\sigma}^S$ refer to the *truncated* fields, i.e. $\boldsymbol{\sigma}^{NS} = \sum_{\ell \in L} \boldsymbol{\sigma}_{\ell|r_\ell}^{NS}$ and $\boldsymbol{\sigma}^S = \sum_{\ell \in L} \boldsymbol{\sigma}_{\ell|r_\ell}^S$.

Remark 1: The difference between this new formulation of the DCM and the superposition method are as follows. The problem \mathcal{P}^{FE} can be decomposed into two sub-problems \mathcal{P}^{FEa} and \mathcal{P}^{FEb} with

$$\mathcal{P}^{FEa} \left\{ \begin{array}{l} \nabla \cdot \boldsymbol{\sigma}^{FEa} + \mathbf{f} = \mathbf{0} \text{ in } \Omega \\ \boldsymbol{\sigma}^{FEa} = \mathbf{E} : \boldsymbol{\varepsilon}^{FEa} \text{ in } \Omega \\ \mathbf{u}^{FEa} = \mathbf{u}_0 - \mathbf{u}^S \text{ at } \partial\Omega_u \\ \boldsymbol{\sigma}^{FEa} \cdot \mathbf{n} = \mathbf{t} - \boldsymbol{\sigma}^S \cdot \mathbf{n} \text{ at } \partial\Omega_\sigma \end{array} \right. \quad (15)$$

and

$$\mathcal{P}^{FEb} \left\{ \begin{array}{l} \nabla \cdot \boldsymbol{\sigma}^{FEb} = \mathbf{0} \text{ in } \Omega \\ \boldsymbol{\sigma}^{FEb} = \mathbf{E} : (\boldsymbol{\varepsilon}^{FEb} - \boldsymbol{\varepsilon}^p) \text{ in } \Omega \\ \mathbf{u}^{FEb} = \mathbf{u}^{NS} \text{ at } \partial\Omega_u \\ \boldsymbol{\sigma}^{FEb} \cdot \mathbf{n} = \boldsymbol{\sigma}^{NS} \cdot \mathbf{n} \text{ at } \partial\Omega_\sigma. \end{array} \right. \quad (16)$$

The superposition method can be written as

$$\mathcal{P}^{SP} = \mathcal{P}^{FEa} + \mathcal{P}^S \quad (17)$$

and the DCM can be written as

$$\mathcal{P} = \left(\mathcal{P}^{FEa} + \mathcal{P}^S \right) + \mathcal{P}^{FEb} - \mathcal{P}^{NS}. \quad (18)$$

The DCM can then be seen as an extension of the superposition method to which two sub-problems are added. Even though at first sight these two added sub-problems may appear as incurring extra computation costs, their introduction can

1
2
3
4
5
6
7
8
9 actually lead to major computational cost savings with respect to the superposition
10 method and even with respect to classical DD.

11
12 In the \mathcal{P}^{SP} problem the dislocation segments interact with each other through
13 problem \mathcal{P}^S , where each segment generates a slowly decreasing stress field (as
14 $1/r$) around its core which cannot be truncated without major loss of accuracy.
15 This leads to a N -segment problem, *a priori* of $O(N^2)$ complexity, in which each
16 dislocation segment interacts with every other one. The *a priori* here means that
17 some advanced technique such as the Fast Multipole Method (FMM) ([32–34])
18 might be used to reduce this complexity to $O(N\log(N))$ or ideally to $O(N)$ as-
19 suming that the heterogeneity of the dislocation density in the simulated volume
20 can be effectively subdivided into a hierarchical structure.
21
22

23
24 In the new DCM formulation each dislocation segment interacts with all the
25 other segments through problem \mathcal{P}^{FE} , but, thanks to the truncation in equation
26 (13), only with neighbouring segments at $r < r_l$ in \mathcal{P}^{NS} and \mathcal{P}^S . For the latter
27 two problems the complexity *a priori* then becomes of order $O(N \times N_l)$, where N_l
28 is the average number of segments at $r < r_l$. Given that r_l must be of the order
29 of the element size of the mesh used in problem \mathcal{P}^{FE} (see [22]) and assuming
30 a structured mesh for a cubic simulated volume, N_l is of the order N/n_{elem} , with
31 n_{elem} the number of elements of the mesh. Then the complexity for \mathcal{P}^{NS} and \mathcal{P}^S
32 remains $O(N^2)$ but with a prefactor of the order $1/n_{elem}$, which can easily reach
33 10^{-5} or 10^{-6} .
34
35

36
37 The FE part of the DCM then plays a similar role as the FMM in standard DD
38 simulation codes, because both carry the long-range dislocation-dislocation inter-
39 actions and thereby significantly reduce the $O(N^2)$ complexity of the problem. In
40 the DCM it has the added advantage of also taking into account the external loads.
41
42
43
44
45
46
47
48
49
50
51
52
53
54
55
56
57
58

1
2
3
4
5
6
7
8
9 For extremely high segment densities and a large cutoff radius some combination
10 of the two methods might be thought of to reduce the computing load for interac-
11 tions within the cutoff radius, however, this is not the point of the present paper.
12
13
14

15
16 **Remark 2:** The new DCM decomposition of the stress field $\boldsymbol{\sigma} = \boldsymbol{\sigma}^{FE} - \boldsymbol{\sigma}^{NS} + \boldsymbol{\sigma}^S$
17 can also be interpreted through a different spatial decomposition of the interac-
18 tions. On the one hand, the stress $\boldsymbol{\sigma}^R \equiv \boldsymbol{\sigma}^{FE} - \boldsymbol{\sigma}^{NS}$, which might be called the
19 remote stress field, represents the influence of the external loads and the remote
20 dislocations and other defects including free surfaces and interfaces, that lie at a
21 distance $r > r_l$ from the considered point. The stress contribution $\boldsymbol{\sigma}^{NS}$ can then
22 be seen as a filter that removes the influence of the dislocations lying at a distance
23 $r < r_l$ from $\boldsymbol{\sigma}^{FE}$. On the other hand, the influence of these nearby dislocations is
24 handled by $\boldsymbol{\sigma}^S$.
25
26
27
28
29
30
31
32
33
34

35 2.2. Regularisation of the plastic slip and its interpolation with the new eigen- 36 strain distribution 37

38
39 Following the formalism developed in the previous section, the eigenstrain distri-
40 bution used in the DCM must be such that:
41

- 42 1. it is constructed additively over the set of dislocation loops L , *i.e.* $\boldsymbol{\epsilon}^P =$
43 $\sum_{\ell \in L} \boldsymbol{\epsilon}_\ell^P$,
44
- 45 2. for each $\ell \in L$, $\boldsymbol{\sigma}_\ell^S - \boldsymbol{\sigma}_\ell^{NS}$ decreases rapidly to zero away from the dislocation
46 line forming the loop ℓ ,
47
- 48 3. one can easily compute the stress field of problem \mathcal{P}^{NS} .
49
50
51
52
53

54 It can be noted that such an eigenstrain distribution can be derived exploiting the
55 Burgers vector distribution function proposed by *Cai et al.* [3] in the context of
56
57
58

1
2
3
4
5
6
7
8
9 the development of a non-singular continuum theory of dislocations. The eigen-
10 strain distribution, used in the eigenstrain problem \mathcal{P}^{FE} , is calculated spreading
11 isotropically the Burgers vector using a specific function denoted \tilde{w} . In the fol-
12 lowing the notation of [3] is used. The analytical expressions for the stress field
13 derived from the Burgers vector distribution function \tilde{w} are not reproduced here.
14 These expressions are needed in the DCM to construct the stress field $\boldsymbol{\sigma}^{NS}$, solu-
15 tion of \mathcal{P}^{NS} .
16
17
18
19
20
21

22 As stated in [3], using \tilde{w} in the FE problem \mathcal{P}^{FE} the stress field $\tilde{\boldsymbol{\sigma}}^{FE}$ is ob-
23 tained from the resolution of the elasticity problem. The stress field $\tilde{\boldsymbol{\sigma}}^{FE}$ must be
24 convoluted by \tilde{w} in order to get the stress field $\boldsymbol{\sigma}^{FE}$ (see equation (33) of [3]). The
25 main advantage is that with this convolution step the interpolation of the stress
26 field from the IP of the FE mesh to the centres of the dislocation segments can
27 be done without introducing any *unwanted* smoothing of this field, as was the
28 case in the previous formulations of the DCM. The practical procedure for the
29 construction of the eigenstrain distribution for problem \mathcal{P}^{FE} is now presented in
30 detail.
31
32
33
34
35
36
37
38

39 In the DD part of the DCM, the dislocation segments i glide producing a plane
40 trapezoidal swept area A_i (the light grey area shown in Fig. 2a). An elementary
41 dislocation segment $d\ell$ located at \mathbf{x}_0 , gliding a distance dy in its slip plane, sweep-
42 ing out an area $d\mathbf{A} = \mathbf{n} d\ell dy$ (with \mathbf{n} its normal), generates an elementary plastic
43 shear distribution $d\boldsymbol{\varepsilon}^P$ given by
44
45
46
47
48
49

$$50 \quad d\boldsymbol{\varepsilon}^P(\mathbf{x}) = \tilde{w}_{r_c}(\|\mathbf{x} - \mathbf{x}_0\|, h) \frac{\mathbf{b} \otimes d\mathbf{A} + d\mathbf{A} \otimes \mathbf{b}}{2}, \quad (19)$$

51
52
53
54
55
56
57
58

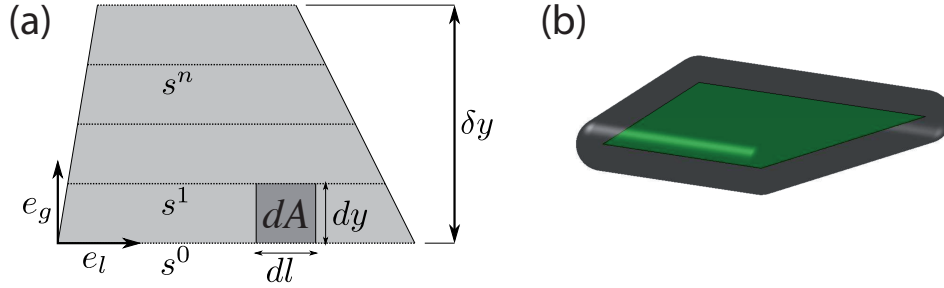

Figure 2: (a) Swept area A_i for a single dislocation segment i during a time step. The elementary eigenstrain distribution \bar{w}_{r_c} is integrated continuously in the direction \mathbf{e}_l and discretely in the direction \mathbf{e}_g . The glide of the segment over a length δy is decomposed into n glide increments of length dy . The s^k denote the successive positions of the segment along the n glide increments. (b) Geometry of the inclusion (in grey) generated by the homogenisation of the swept area A_i (in green).

where h is the homogenisation length and $\bar{w}_{r_c}(r, h)$ is the function $\tilde{w}(r, h)$ of [3] for spreading out the Burgers vector

$$w(r, h) = \frac{15h^4}{8\pi(r^2 + h^2)^{7/2}}, \quad (20)$$

$$\tilde{w}(r, h) = 0.3425w(r, 0.9038h) + 0.6575w(r, 0.5451h), \quad (21)$$

except that it is truncated at a distance $r = r_c$ from \mathbf{x}_0 :

$$\bar{w}_{r_c}(r, h) = \mathcal{H}(r_c - r)\tilde{w}(r, h) \quad (22)$$

with \mathcal{H} the Heaviside step function.

For saving computational time, r_c should be as small as possible, but for too small values the difference between \bar{w}_{r_c} and \tilde{w} would lead to loss of a large amount of plastic shear strain. Fig. 3 shows the influence of the cut-off radius r_c on the integral over the whole space of \bar{w}_{r_c} . Its value tends to 1 when $r_c \rightarrow \infty$ (*i.e.* when $\bar{w}_{r_c} \rightarrow \tilde{w}$). In the DCM calculations reported in this paper the value $r_c = 1.75h$ is

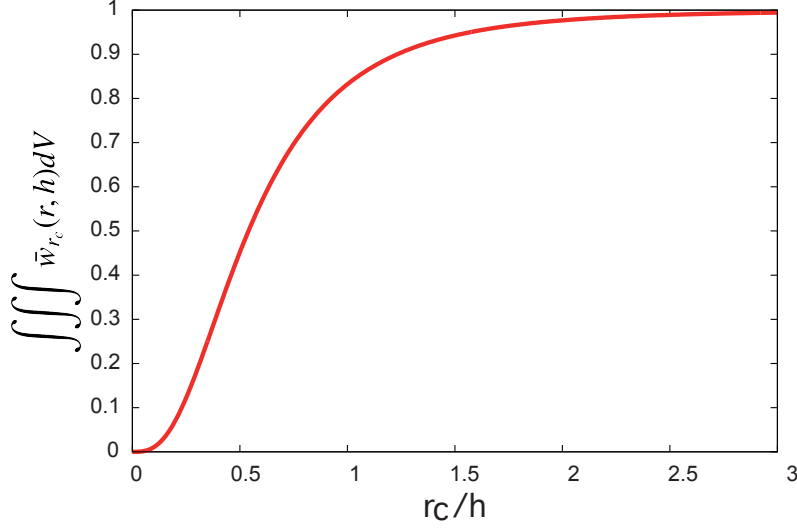

Figure 3: Influence of the cutting radius r_c on the value of the integral of \bar{w}_{r_c} , with h the homogenisation length.

Similarly to the previous version of the DCM (see [22]), the geometry and the distribution of the eigenstrain resulting from a finite swept area is the union of the geometry of, and the eigenstrain associated to the elementary spherical inclusions $d\Phi_{\mathbf{x}_0}$ of radius r_c associated to each point of the swept area. An example of the resulting shape of the inclusion is shown in Fig. 2b. Then, an IP of the FE mesh at position \mathbf{x} gets attributed the sum of the elementary shear of every spherical inclusion $d\Phi_{\mathbf{x}_0}$ containing \mathbf{x} . Formally

$$\boldsymbol{\varepsilon}^p(\mathbf{x}) = \sum_{A_i \in \{A\}} \mathbf{e}_i \mathcal{I}_i(\mathbf{x}) \quad (23)$$

with

$$\mathcal{I}_i(\mathbf{x}) \equiv \int_{\mathbf{x}_0 \in A_i} \bar{w}_{r_c}(\|\mathbf{x} - \mathbf{x}_0\|, h) d\mathbf{x}_0^2 \quad (24)$$

1
2
3
4
5
6
7
8
9 where the notation dx_0^2 denotes a surface integral and $\mathbf{e}_i = \frac{1}{2}(\mathbf{b}_i \otimes \mathbf{n}_i + \mathbf{n}_i \otimes \mathbf{b}_i)$
11 with \mathbf{b}_i and \mathbf{n}_i the Burgers vector and the unit normal vector of the swept area A_i ,
12 respectively. $\{A\}$ is the whole set of swept areas.
13
14

15 In the following part of this paragraph, the subscript i is omitted for clarity.
16 The integral $\mathcal{J}(\mathbf{x})$ is integrated continuously in the direction of the dislocation
17 line (\mathbf{e}_l in Fig. 2a) and in a discrete way in the glide direction (\mathbf{e}_g in Fig. 2a). In
18 the local reference frame ($\mathbf{e}_l, \mathbf{e}_g$), the glide distance δy along \mathbf{e}_g during the time
19 step δt of a segment s is decomposed into n elementary glides $dy \equiv \delta y/n$. Then
20
21
22
23

$$24 \mathcal{J}(\mathbf{x}) \simeq dy \sum_{k=1}^n \int_{\mathbf{x}_0 \in s^k} \bar{w}_{r_c}(\|\mathbf{x} - \mathbf{x}_0\|, h) d\mathbf{x}_0, \equiv dy \sum_{k=1}^n \mathcal{J}^k(\mathbf{x}) \quad (25)$$

26 where s^k refers to the segment s of length l^k at position k . For the computation of
27 the integral $\mathcal{J}^k(\mathbf{x})$, the integration and truncation operations are inversed accord-
28 ing to
29
30
31
32

$$33 \mathcal{J}^k(\mathbf{x}) \simeq \mathcal{H}(r_c - \|\mathbf{x} - \mathbf{x}^k\|) \mathcal{L}^k(\mathbf{x}), \quad (26)$$

34 where \mathbf{x}^k refers to the closest point to \mathbf{x} on s_k and
35
36
37

$$38 \mathcal{L}^k(\mathbf{x}) = \int_{\mathbf{x}_0 \in s^k} \tilde{w}_{r_c}(\|\mathbf{x} - \mathbf{x}_0\|, h) d\mathbf{x}_0. \quad (27)$$

39 This last integral $\mathcal{L}^k(\mathbf{x})$ is calculated analytically. To this end, a new local frame
40 ($\mathbf{C}_k, \mathbf{e}_l, \mathbf{e}_x^k$) is considered, with \mathbf{C}_k the centre of the segment s^k and \mathbf{e}_x^k the unit
41 vector normal to s^k and pointing to \mathbf{x} (see Fig. 4). With (x, y) the position of \mathbf{x} in
42 the local frame, $q = y^2 + h^2$, $p = x - x_0$:
43
44
45
46
47
48
49

$$50 \mathcal{L}^k(x, y) = \left[\frac{h^4 p (15q^2 + 20qp^2 + 8p^4)}{8\pi q^3 (q + p^2)^{5/2}} \right]_{p=x_0-l^k/2}^{p=x_0+l^k/2}. \quad (28)$$

51 As stated above, the stress field $\tilde{\boldsymbol{\sigma}}^{FE}$ computed with the FE code at the IP and
52 using the eigenstrain distribution as defined above, must be convoluted with \tilde{w} .
53
54
55
56
57
58

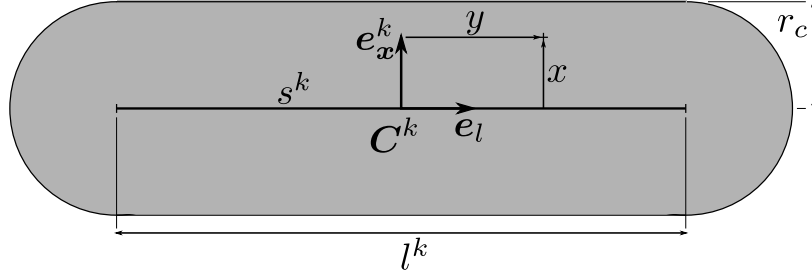

Figure 4: Local frame for the computation of \mathcal{J}^k at point \mathbf{x} . The grey shaded area refers to the support of the function \mathcal{J}^k in this local frame: if the point \mathbf{x} is located outside this area, no eigenstrain will be attributed to it.

Thus $\boldsymbol{\sigma}^{FE}(\mathbf{x})$ at any point \mathbf{x} is given by

$$\boldsymbol{\sigma}^{FE}(\mathbf{x}) = \int_{\mathbb{R}^3} \bar{w}(\|\mathbf{x}_0 - \mathbf{x}\|) \tilde{\boldsymbol{\sigma}}^{FE}(\mathbf{x}_0) d\mathbf{x}_0^3, \quad (29)$$

where the notation $d\mathbf{x}_0^3$ denotes a volume integral. This integral is approximated numerically using the IP, as following:

$$\boldsymbol{\sigma}^{FE}(\mathbf{x}) \simeq \frac{\sum_{j \setminus \|\mathbf{p}_j - \mathbf{x}\| < r_c} \bar{w}(\|\mathbf{p}_j - \mathbf{x}\|) \tilde{\boldsymbol{\sigma}}^{FE}(\mathbf{p}_j) V_j}{\sum_{j \setminus \|\mathbf{p}_j - \mathbf{x}\| < r_c} \bar{w}(\|\mathbf{p}_j - \mathbf{x}\|) V_j}, \quad (30)$$

where \mathbf{p}_j is the position of IP j and V_j its associated volume.

2.3. Interface handling

In the DCM, the simulated volume Ω is delimited by periodic interfaces or by material interfaces. The treatments of those two kinds of interface differ and are described in this section.

2.3.1. Periodic interfaces

The dislocation dynamics and therefore the swept areas calculated with the DD code are by definition always located inside Ω . When periodic boundary con-

1
2
3
4
5
6
7
8
9 conditions are used and when a dislocation segment crosses a periodic interface, it
10 reappears inside Ω modulo the linear dimensions of the simulated periodic vol-
11 ume. In the DD code the presence of a periodic medium is taken into account in
12 a conventional way for the calculation of the local correction stress σ^{LC} and does
13 need any special procedure for the DCM. Hence at each segment centre σ^{LC} is
14 calculated considering the closest dislocation segments surrounding this point in
15 the simulated periodic dislocation microstructure.
16
17
18
19
20
21

22 In the FE code a specific treatment is needed to compute the eigenstrain distri-
23 bution near the boundaries of the FE mesh. Periodic replicas of those swept areas
24 lying totally or partially at a distance smaller than the cut-off distance r_c of the
25 periodic FE mesh limits are created, and the regularisation procedure then takes
26 these replicas into account in the same manner as the regular swept areas. Hence,
27 a periodic dislocation microstructure can exactly be taken into account. This ad-
28 ditional procedure is illustrated in Fig. 5 in two dimensions. The process is the
29 same in three dimensions: if a swept area lies in the r_c -vicinity of one periodic
30 interface, it generates one replica, if it lies in the r_c -vicinity of two periodic inter-
31 faces, it generates three replicas, and if it lies in the r_c -vicinity of three periodic
32 interfaces, it generates seven replicas.
33
34
35
36
37
38
39
40
41
42
43
44

45 **Remark 3:** Here again, the truncation of the stress fields computed by the DD
46 code (equation (13)) provides large gains in computational cost as compared to
47 the superposition method or to classical DD. Indeed, successive layers of periodic
48 replicas of the simulated volume do not need to be considered anymore for the
49 stress calculation, assuming that the simulated volume is big enough to contain a
50 sphere of radius r_l .
51
52
53
54
55
56
57
58
59
60
61
62
63
64
65

1
2
3
4
5
6
7
8
9
10
11
12
13
14
15
16
17
18
19
20
21
22
23
24
25
26
27
28
29
30
31
32
33
34
35
36
37
38
39
40
41
42
43
44
45
46
47
48
49
50
51
52
53
54
55
56
57
58
59
60
61
62
63
64
65

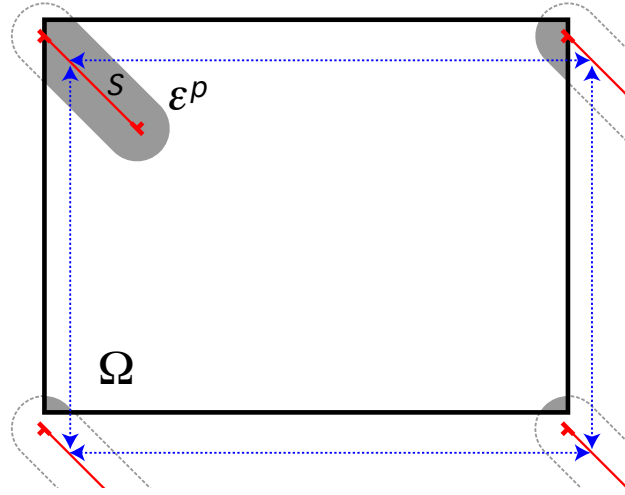

Figure 5: Two-dimensional example of the replicas of a glide area swept by a segment in the r_c -vicinity of the FE mesh boundaries (bold black lines). The blue arrows point to the periodic replicas that have to be generated to get a full periodic eigenstrain distribution $\boldsymbol{\varepsilon}^p$, which corresponds to the union of all grey areas.

2.3.2. Material interfaces

The problem of material interfaces in the DCM must be decomposed in two cases: those penetrable and those impenetrable by dislocations.

The problem of impenetrable interfaces is simple and no additional treatment is needed in the DCM procedures. More precisely, in the DD code the dislocation segments arriving at an impenetrable interface are simply blocked there. In the FE code, the slipped areas including those due to the dislocation segments within the vicinity of the interface are regularised only to those IP lying on the same side of the interface as the slipped areas but not beyond. In this case, the main numerical error appearing in DCM computations is limited to the close vicinity of interfaces and comes from the expressions for the local stress correction σ^{LC} which do not account for the presence of two elastic media. The case of a free surface, denoted

1
2
3
4
5
6
7
8
9 $\partial\Omega_f \subset \partial\Omega$, is less straightforward. Consider a dislocation loop whose dislocation
10 line is denoted by ℓ . Its movement generates a slipped area, denoted A , corre-
11 sponding to the set of points in the slip plane delimited by ℓ , *i.e.* ℓ is the boundary
12 of A . The set of points \mathcal{B} of the loop at the interface (forming a line segment or a
13 poly-line segment) is then simply defined by $\mathcal{B} = A \cap \partial\Omega_f$.
14
15
16
17
18

19 When $\mathcal{B} \neq \emptyset$ different strategies can be considered. A first strategy depicted
20 in Fig. 6-a would consist in arresting the dislocation line at the interface, as for
21 the impenetrable case. This simple strategy has two main drawbacks. First, the
22 DD code has to keep track of this part of the line which does not generate stress
23 in the recomposed problem \mathcal{P} . Secondly, it introduces singular boundary terms
24 ($\mathbf{u}^S - \mathbf{u}^{NS}$ on $\partial\Omega_u$, $\boldsymbol{\sigma}^S - \boldsymbol{\sigma}^{NS}$ on $\partial\Omega_\sigma$) on a “large” surface of $\partial\Omega$ (see Fig. 7-e)
25 which extends when more of ℓ is deposited on the interface.
26
27
28
29
30
31

32 The second strategy is depicted in 6-b. This time, when a section of ℓ reaches
33 the interface, this line section is artificially moved outside the volume in its slip
34 plane and in a direction normal to the line formed by the set of points \mathcal{B} over a
35 distance greater than r_c . The distance to which the dislocation should be moved
36 outside is at least r_c , because any further away a dislocation is not seen any more
37 by the IP of the FE mesh. In particular the swept area should be prolonged in the
38 glide plane to reconstruct a continuous eigenstrain outside the simulated domain.
39 For reasons of simplicity this procedure is currently only implemented for con-
40 vex domains. This solution was found to remove the two drawbacks mentioned
41 above: now the part of the extended dislocation line outside Ω has no mechanical
42 influence anymore and so can be removed from the segment list in the DD code.
43
44
45
46
47
48
49
50
51
52

53 Then, as illustrated in Fig. 7-f, the only singular boundary terms introduced
54 in the $\boldsymbol{\sigma}^{FE}$ problem solved with the FE solver are located at the points where
55
56
57
58

the dislocation line crosses the interface. This is the strategy now adopted in the DCM. In addition, thanks to the localised requirement of the boundary terms ($\mathbf{u}^S - \mathbf{u}^{NS}$ on $\partial\Omega_u$, $\boldsymbol{\sigma}^S - \boldsymbol{\sigma}^{NS}$ on $\partial\Omega_\sigma$) for the FE problem \mathcal{P}^{FE} , the singular boundary terms can be neglected in many computations. Hence, the FE problem that is actually solved is

$$\mathcal{P}^{FE} \left\{ \begin{array}{ll} \nabla \cdot \boldsymbol{\sigma}^{FE} + \mathbf{f} = \mathbf{0} & \text{in } \Omega \\ \boldsymbol{\sigma}^{FE} = \mathbf{E} : (\boldsymbol{\varepsilon}^{FE} - \boldsymbol{\varepsilon}^p) & \text{in } \Omega \\ \mathbf{u}^{FE} = \mathbf{u}_0 & \text{at } \partial\Omega_u \\ \boldsymbol{\sigma}^{FE} \cdot \mathbf{n} = \mathbf{t} & \text{at } \partial\Omega_\sigma. \end{array} \right. \quad (31)$$

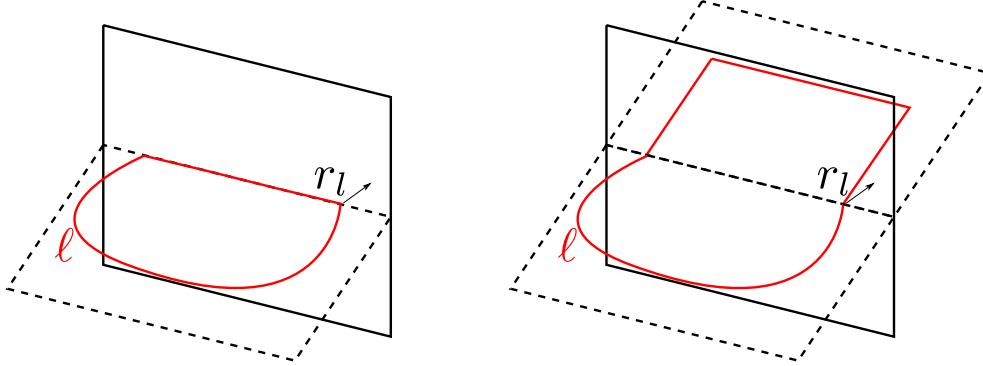

Figure 6: Illustration of the two possible strategies discussed in the text for handling the problem of a dislocation loop touching a penetrable interface. The red line is ℓ . The blue shaded area is the part of $\partial\Omega$ on which boundary terms have to be introduced due to the part of ℓ that is at $\partial\Omega$ or outside Ω .

3. Improvement of numerical performance

3.1. Finite-element quadrature

In the DCM the FE solver computes the stress $\boldsymbol{\sigma}^{FE}$, which is the FE approximation of the solution of the boundary value problem in Ω in the presence of the

1
2
3
4
5
6
7
8
9 eigenstrain distribution, which is discretised to the IP by the regularisation pro-
10 cedure described previously. The choice of the element quadratures, roughly the
11 number of IP per element, has a great influence on the computational costs and
12 may affect the accuracy of the output σ^{FE} in quite a subtle way. Usually with FE
13 computations, the richer the element quadrature, the better the FE solution approx-
14 imates the continuum solution. This common prediction is not straightforward in
15 the DCM as will be shown in this section.
16
17
18
19
20
21

22 When solving the boundary value problem with the FE method, plastic incom-
23 patibilities (the fact that the eigenstrain associated to dislocation slips cannot be
24 written as the symmetric gradient of a displacement field) may lead to the gener-
25 ation of spurious stresses (called “eigenstress” in [24]) at two levels.
26
27
28
29

30 They can appear within an element, if there exists a sampling of the eigen-
31 strain defined at the IP of the element which cannot be fitted by any function of
32 the strain space of the element. This strain space refers to the vector space gen-
33 erated by the symmetrised gradient of the shape functions of the element. For
34 example, consider a linear 4-node tetrahedron element with a 4-IP quadrature. In
35 this element the strain is necessarily constant, whereas the sampling of an eigen-
36 strain at its 4 IP is captured as non constant and then cannot be represented in
37 the space of strain of the element. Elastic strain and its associated stress are then
38 needed to accommodate the plastic strain. In the following we call this first kind
39 of plastic incompatibility ”intra-element“ incompatibility.
40
41
42
43
44
45
46
47
48

49 Another type of plastic incompatibility may arise when two or more adjacent
50 elements are distorted differently due to the plastic strain. Again elastic strain is
51 needed to accommodate this incompatibility. In the following we call this second
52 kind ”inter-element incompatibility“.
53
54
55
56
57
58

1
2
3
4
5
6
7
8
9 Through numerical investigation it appears that avoiding the intra-element in-
10 compatibility improves the quality of the FE solution. The removal of such intra-
11 element plastic incompatibility may be performed using low-order quadrature, *i.e.*
12 elements with a small number of IP. In the following, an element whose quadra-
13 ture is such that any sampling of eigenstrain at its IP can be fitted by a function of
14 its strain space is said to be self-compatible. The influence of the mapping from
15 the reference element to the mesh element is here neglected: elements are con-
16 sidered to be homothetic to their reference element. For example, the quadratic
17 10-node tetrahedron with a 4-IP point quadrature, or the quadratic 20-nodes hex-
18 ahedron with an 8-IP point quadrature (this element is under-integrated) are self-
19 compatible.
20
21
22
23
24
25
26
27
28
29

30 This assertion is now demonstrated with the simple test case of a straight in-
31 finite screw dislocation lying along the z -direction. The computational domain
32 is a rectangular parallelepiped with periodic boundary conditions along the z -
33 directions and free boundaries along the x - and y -directions. The resulting stress
34 field of this configuration can easily be calculated from existing analytical solu-
35 tions [1]. The computational cell shown in Fig. 8 measures $L_z = 100$ nm in the
36 z -direction and $L = 800$ nm in the other two directions. Isotropic elastic constant
37 are used, with shear modulus $\mu = 51$ GPa and Poisson ratio $\nu = 0.37$ and the
38 norm of the Burgers vector, oriented in the z -direction, is $b = 0.25$ nm. The influ-
39 ence of the free boundaries is not commented here. Through the homogenisation
40 procedure of §2.2, the movement of the dislocation from one edge of the compu-
41 tational cell along its slip plane generates a platelike inclusion shown in Fig. 8-a.
42 The only non-zero component ε_{yz}^p of the eigenstrain tensor is shown in Fig. 8-b. It
43 can be observed that, except very close to the dislocation core, ε_{yz}^p does not depend
44
45
46
47
48
49
50
51
52
53
54
55
56
57
58
59
60
61
62
63
64
65

1
2
3
4
5
6
7
8
9 on x inside the eigenstrain inclusion.

10 A regular structured FE mesh is used with $32 \times 32 \times 4$ quadratic hexahedra
11 with 20 nodes and 27 IP. These IP are located on a regular $3 \times 3 \times 3$ grid inside each
12 element. The mesh size is chosen such that the edge length of the elements equals
13 the homogenisation length h . For this case, only one component of the resulting
14 stress field is problematic: σ_{yz} . This component is shown (after convolution with
15 \bar{w}) in Fig. 8-c. One can observe that instead of decreasing smoothly as $1/r$ from
16 the dislocation core as expected, σ_{yz} shows artifacts along the y axis that do not
17 vanish away from the dislocation core. However, the solution of the continuous
18 problem far from the dislocation core is $\{\boldsymbol{\sigma} \rightarrow \mathbf{0}, \boldsymbol{\varepsilon} \rightarrow \boldsymbol{\varepsilon}^p\}$, so the plastic strain
19 should be compatible there.
20
21
22
23
24
25
26
27
28
29

30 These artefacts arising from the intra-element plastic incompatibilities can be
31 understood as follows. Consider an element, far away from the dislocation core,
32 with non-zero eigenstrain. Along the y -direction and passing through the IP, the
33 eigenstrain $\varepsilon_{yz}^p(y)$ given by the regularisation procedure is a non-linear function
34 (and far from the core, the problem is invariant in x and z). The best-fit ap-
35 proximation given by the quadratic FE to this non-linear input $\varepsilon_{yz}^p(y)$ is linear,
36 and this results in alternating positive and negative stresses σ_{yz}^{FE} at the IP. Fortu-
37 nately, if the intra-element incompatibilities are removed by using self-compatible
38 quadratic hexahedra with 20 nodes and 8 IP, these oscillations of the stress σ_{yz}^{FE}
39 disappear, as shown in Fig. 8-d.
40
41
42
43
44
45
46
47
48

49 This first test is an idealised test case because all element edges are parallel
50 and orthogonal to the slip plane of the dislocation. Then, far from the dislocation
51 core, there are no inter-element plastic incompatibilities. A more general case is
52 now considered where the element edges are not aligned with the slip plane of
53
54
55
56
57
58
59
60
61
62
63
64
65

1
2
3
4
5
6
7
8
9 the dislocation by rotating the mesh with respect to the slip plane and the Burgers
10 vector. Figures 9 give the results of this second case (again after convolution) for
11 the 20-node hexahedron with 27 IP and the self-compatible 20-node hexahedron
12 with 8 IP. Both solutions show spurious oscillations far from the the dislocation
13 core. These oscillations result from both intra and inter-element incompatibilities
14 for the non-self-compatible hexahedron, and only from inter-element incompatibilities
15 for the self-compatible hexahedron. The solution for the 8-IP element
16 is not only cheaper but appears to be slightly better. Naturally, the FE solution
17 converges to the expected solution when refining the mesh for both the under-
18 integrated element (allowing only inter-element plastic incompatibilities) and the
19 fully-integrated element (allowing inter and intra-element plastic incompatibili-
20 ties). Fig. 9-d shows the result for the self-compatible element for a finer mesh,
21 with 4 elements across the homogenisation length. However for a given mesh, the
22 FE solution is cheaper in terms of computational costs and at least as good with
23 elements that do not allow intra-element plastic incompatibilities. The same con-
24 clusions can be given with 10-node 4-IP tetrahedra, as shown in the comparison
25 of the σ_{xx}^{FE} component in Fig. 10.

26
27
28
29
30
31
32
33
34
35
36
37
38
39
40
41
42 As a conclusion of this section, it appears through numerical investigation that
43 the choice of self-compatible elements, roughly with a small number of IP, offers
44 a better compromise between accuracy and costs with respect to the choice of
45 elements with high order quadratures.
46
47
48
49

50 3.2. Time integration

51
52 In this section the question of the numerical time integration scheme in the FE
53 part is addressed, specifically with respect to the internal variable ϵ^P .
54
55

56 In the DCM, the DD time step δt is given by physical considerations and then
57
58

1
2
3
4
5
6
7
8
9 is a fixed parameter of the algorithm for the integration of the evolution problem.
10 As noted in §2, the total stress field $\boldsymbol{\sigma} = \boldsymbol{\sigma}^{FE} - \boldsymbol{\sigma}^{NS} + \boldsymbol{\sigma}^S$ can be decomposed
11 into a remote stress field $\boldsymbol{\sigma}^R = \boldsymbol{\sigma}^{FE} - \boldsymbol{\sigma}^{NS}$ and a short-range stress field $\boldsymbol{\sigma}^S$. The
12 remote stress field accounts for the interaction of the dislocations and boundaries
13 lying at a distance $r > r_l$ to each point whereas the short-range stress field accounts
14 for the dislocations lying at a distance $r < r_l$. Although the short-range part is
15 very sensitive to small variations of segment positions due to its singularity, the
16 remote part is much less sensitive to details of the spatial dislocation distribution
17 in the microstructure. Therefore a larger time step Δt can be used for updating the
18 remote contribution of the stress field than for the short-range part. This is why
19 the FE problem may be solved only every $\Delta t = m \delta t$, where δt is the DD time
20 step and $m \in \mathbb{N}$ is called the time step ratio.
21
22
23
24
25
26
27
28
29
30
31

32 Through the FE simulation, one has to integrate the evolution of the internal
33 variable $\boldsymbol{\varepsilon}^P$ over each Δt to get the plastic strain increment $\Delta \boldsymbol{\varepsilon}^P$. Historically an
34 implicit integration scheme was used in the DCM [20, 22]:
35
36
37

$$38 \quad \boldsymbol{\varepsilon}^P(t + \Delta t) - \boldsymbol{\varepsilon}^P(t) = F(\Delta t, \boldsymbol{\varepsilon}^P(t + \Delta t)) \quad (32)$$

39
40
41 where F represents the DD simulation. This leads to a non-linear global FE sys-
42 tem of equations which is solved using a quasi-Newton algorithm. The main
43 drawback of this approach is that it is highly CPU consuming as at each iteration
44 of the quasi-Newton scheme, the DD simulation of the whole m DD time step
45 matching the considered Δt has to be carried out once again. Furthermore, at each
46 iteration the stress needs to be interpolated to the dislocation segments.
47
48
49
50
51
52

53 Alternatively an explicit scheme is now proposed in the DCM:
54
55

$$56 \quad \boldsymbol{\varepsilon}^P(t + \Delta t) - \boldsymbol{\varepsilon}^P(t) = F(\Delta t, \boldsymbol{\varepsilon}^P(t)) \quad (33)$$

1
2
3
4
5
6
7
8
9 where $\Delta\boldsymbol{\varepsilon}^p$ is computed explicitly and remains constant all along the FE time step.
10 Therefore the global FE system becomes linear during each FE time step. Further-
11 more, the stiffness matrix is unchanged as long as the mesh and the topology of
12 the Dirichlet boundary conditions are unchanged throughout the simulation. It
13 can then be factorised once and for all. Practically, the explicit procedure to solve
14 the DCM problem during $\Delta t = m\delta t$ is:
15
16
17
18
19

- 20
21 1. The stress field $\boldsymbol{\sigma}^{FE}$ is interpolated by means of a convolution (see §2.1) to
22 the dislocation segments.
23
- 24 2. The DD code computes the non-singular part of the local correction $\boldsymbol{\sigma}^{NS}$
25 for each segment.
26
27
- 28 3. The DD code solves the dynamics of the dislocation segments for m DD
29 time steps δt , updating $\boldsymbol{\sigma}^S$ every δt for each segment, but not $\boldsymbol{\sigma}^R$. When
30 a segment is discretised in smaller segments or when segments are merged
31 during the m DD time steps, rules are defined in the DD code to interpolate
32 $\boldsymbol{\sigma}^R$ for the new segments based on the nearest defined segment solution
33 (usually the nearest connected segments along the dislocation line).
34
35
- 36 4. The eigenstrain increment $\Delta\boldsymbol{\varepsilon}^p$ is computed from the areas $\{\Delta A\}$ slipped
37 during the m DD time steps following the regularisation procedure pre-
38 sented in §2.2.
39
40
- 41 5. The FE code solves its linear boundary value problem to get $\boldsymbol{\sigma}^{FE}$ at $t + \Delta t$.
42
43
44
45
46
47

48 The key steps of this procedure are represented schematically in Fig. 11. Gen-
49 erally, the drawback of using an explicit scheme is that it can become unstable
50 and then requires very small time steps. However, in order to properly catch the
51 contact interactions between the dislocation segments, the DD time step is con-
52 strained to values that are much smaller than the maximum time step ensuring FE
53
54
55
56
57
58

1
2
3
4
5
6
7
8
9 stability. In other words, the time step is assumed to be precision-limited, and not
10 stability-limited. In all the tests that were carried out, with DD time steps δt based
11 on physical considerations and time step ratio m up to 100, no significant instabil-
12 ity has ever shown up. It can be noted that if problematic instabilities would show
13 up in some simulations, using an implicit integrator for the short range interac-
14 tions computed through the m DD steps but keeping a simple forward Euler for
15 the long range interactions computed by the FE code, as suggested in [35], would
16 be possible.
17
18
19
20
21
22
23
24

25 3.3. *Data communication between FE and DD codes*

26 Data communication between the FE and DD codes has been optimized. Data
27 exchange can be done either at the IP of the FE mesh, or at the segment integra-
28 tion points (SIP) for dislocation dynamics. In previous DCM versions all data
29 exchange was done at the IPs and all homogenisation and localisation operations
30 were done in the DD code. However for large FE meshes the number of IP is much
31 larger than the number of SIP and so the data exchange is now done with respect
32 to the SIP coordinates. On the one side, the DD code sends the locations of the
33 SIP to the FE code, and the FE code interpolates its stress field there (through the
34 convolution defined in §2.1) and sends it back to the DD code. On the other side,
35 the DD code sends the areas swept by the moving dislocation segments to the FE
36 code, from which the FE code computes the plastic strain at its IP following the
37 homogenisation procedure explained in §2.2. In short, in Fig. 11 this means that
38 the two central boxes Interpolation and Regularisation are now attached to the FE
39 code instead of the DD code, as they were before. As a side effect this allowed
40 clearing up many redundant data structures in our codes.
41
42
43
44
45
46
47
48
49
50
51
52
53
54
55
56
57
58
59
60
61
62
63
64
65

3.4. Proximity localisation

Following the homogenisation procedure (§2.2), for each IP it has to be determined whether it lies at a distance $r > r_c$ from each segment, or not. If $r > r_c$ nothing has to be done. Otherwise, an increment of plastic strain has to be calculated for that IP. A brute-force approach would consist of computing the distance from each IP to each dislocation segment. This would require operations of the order of $O(n_{seg} \times n_{ip})$, where n_{seg} is the number of segments and n_{ip} the number of IP, which may become prohibitive for large calculations. Fortunately, there exist more efficient solutions. This problem of efficiently determining which IP lie in the r_c -range of dislocation segments can be seen as n_{seg} classical range searching problems (see [36, 37] for a definition of the range searching problems and overviews of different solving techniques): for each moving segment k , one has to determine which IP lie in its range, defined as the portion of space $\Omega_k = \{\mathbf{x} \in \mathbb{R}^3 \text{ such that the distance from } \mathbf{x} \text{ to segment } k \text{ is smaller than } r_c\}$. The techniques for solving this problem efficiently are based on a pre-processing of the cloud of points on which localisation information can be queried. For most of them, a tree data structure is constructed in which these points are spatially and hierarchically sorted.

In the DCM, each n_{seg} range searching problem \mathcal{P}_k is solved in two stages: first, a simpler problem \mathcal{P}_k^* is solved by replacing Ω_k by its axis-aligned bounding box Ω_k^* (\mathcal{P}_k^* falls in the category of orthogonal range searching problems). Then, the candidate IP inside Ω_k^* are checked one by one whether they actually belong to Ω_k . The IP cloud is pre-processed at the beginning of the simulation into a “bounding volume hierarchy” whose bounding volumes are again axis-aligned bounding boxes. This pre-processing has to be carried out only once because

1
2
3
4
5
6
7
8
9 remeshing is not yet done for DCM simulations, so it is unchanged throughout the
10 simulation. Each problem \mathcal{P}_k can then be solved with a complexity $O(\log(n_{ip}))$.
11 Thus the localisation of the IP with respect to the dislocation segments has a
12 $O(n_{seg} \log(n_{ip}))$ complexity, i.e. it is performed with high efficiency.
13
14
15
16
17

18 **4. Validation and performance tests**

19
20 In this section, several elementary validation tests are presented in order to demon-
21 strate the results and the performance of the improved formulation of the DCM.
22 Tests with more complex geometries and higher dislocation densities will be pre-
23 sented in a forthcoming paper.
24
25
26
27
28

29 *4.1. Validation tests*

30
31 This first elementary test aims at validating the modified local correction proposed
32 in §2. The elastic fields of a infinite, straight single edge or screw dislocation
33 lying along the z -direction were reconstructed using the DCM and compared to
34 analytical solutions. The DCM stress field $\boldsymbol{\sigma} = \boldsymbol{\sigma}^{FE} + \boldsymbol{\sigma}^{NS} - \boldsymbol{\sigma}^S$ was expected to
35 be as close as possible to the analytical singular stress field $\boldsymbol{\sigma}^S$. The geometry of
36 the computational cell and the boundary conditions were the ones used in §3.1.
37 In this test the influence of the free boundaries was considered negligible because
38 computed and analytic solutions for the dislocation stress field were compared
39 sufficiently far away from the boundaries.
40
41
42
43
44
45
46
47

48 The computational cell measured $L_z = 0.127 \mu\text{m}$ in the z -direction and $L =$
49 $1.27 \mu\text{m}$ in the other two directions. The crystal was assumed to be isotropic, with
50 shear modulus $\mu = 51 \text{ GPa}$ and Poisson ratio $\nu = 0.37$. The norm of the Burgers
51 vector was $b = 0.25 \text{ nm}$. The dislocation glided on a y -oriented plane from the
52 $-x$ -oriented face of the plate to the centre of the plate. For the FE problem, a
53
54
55
56
57
58

1
2
3
4
5
6
7
8
9 structured mesh consisting of $80 \times 80 \times 8$ quadratic 20-node, 8-IP hexahedra was
10 used. For the regularisation, the homogenisation length was $h = 125b = 31.9$
11 $\text{nm} \approx L/40$ and the cutting radius was $r_c = 2h = 63.8 \text{ nm} \approx L/20$. The local
12 correction radius was $r_l = 2.5h = 79.8 \text{ nm} \approx L/16$.
13
14

15
16
17 2D color maps of the fields around the dislocation core are shown in Fig. 12.
18 Only the non-zero components are represented. It can be observed that the abso-
19 lute error $\boldsymbol{\sigma} - \boldsymbol{\sigma}^S$ is very small with respect to the amplitude of the stress fields.
20 For the screw dislocation the maximum absolute error is located within the local
21 correction area whereas for the edge dislocation, the maximum absolute error is
22 located at $r = r_l$ where the DCM field shows some small discontinuities.
23
24
25
26
27

28
29 Figures 13 and 14 show graphs of the component yz for the screw dislocation
30 and xy for the edge dislocation along the x axis. The relative error with respect to
31 the reference field $\boldsymbol{\sigma}^S$ is smaller than 5% for the screw dislocation and 8% for the
32 edge dislocation. It is important to underline that the relative errors on the screw
33 and on the edge component plotted in Fig. 12, Fig. 13 and 14 tend to zero as r_c and
34 r_l increase. Here the values for r_c and r_l were chosen to find a good compromise
35 between accuracy and performance of the DCM computations.
36
37
38
39
40
41

42 4.2. Performance tests

43
44 In order to test how the modifications presented in this paper really affect DCM
45 performances, the duration of DCM time steps were compared with classical DD
46 simulation time steps in a stress relaxation simulation.
47
48
49

50
51 A cubic simulation box with $L_x = L_y = L_z = 5.0 \mu\text{m}$ was chosen and periodic
52 boundary conditions were applied. Calculations were run with three different
53 initial dislocation densities: $0.9 \times 10^{12} \text{ m}^{-2}$ (*i.e.* an average number of segments
54 $n_{seg} \approx 2800$ during the calculation), $1.0 \times 10^{13} \text{ m}^{-2}$ ($n_{seg} \approx 33000$) and $5.2 \times$
55
56
57
58

1
2
3
4
5
6
7
8
9 10^{13} m^{-2} ($n_{seg} \approx 155000$). No external loading was applied, so the dislocation
10 dynamics was only driven by stress relaxation which includes many dislocation-
11 dislocation reactions.
12
13

14
15 In the DCM, for each dislocation density, three regular structured meshes were
16 considered: $12 \times 12 \times 12$ elements with element edge $h_e = 830 \text{ nm}$, $24 \times 24 \times 24$
17 with $h_e = 415 \text{ nm}$ and $48 \times 48 \times 48$ with $h_e = 208 \text{ nm}$. The time step ratio is
18 set to 1. In the classical DD simulations, for each dislocation density, the long
19 range stress contribution was calculated with three different levels of approxima-
20 tion. Indeed, the exact solution of the periodic boundary conditions problem is
21 formally difficult in 3D DD simulations and implies very intensive computations
22 because an infinite number of periodic replicas would have to be taken into ac-
23 count. This problem does not exist in the DCM simulations because the periodic
24 solution is easily obtained through the periodic displacement conditions applied
25 in the elastic FE solver. In the DD simulations, the simulated volume is translated
26 periodically by nL_x , nL_y and nL_z to give $n = 0, 1$ and 2 layers of replicas around
27 the primary simulation box. Numerically, this translation is applied with the help
28 of the FMM algorithm and therefore induces a only a moderate increase of the
29 long-range stress field calculation in the classical DD simulations. More detail
30 on the replica procedure and the multi-pole algorithm used in the DD simulation
31 code microMegas can be found in [30]. The DD parts in both types of calcula-
32 tions were executed in parallel with MPI libraries using 12 CPU cores for each
33 simulation on a Intel Xeon X5670 machine, and the FE parts of the MDC calcula-
34 tions were executed on the same machine with 12 threads of the multithreaded
35 FE solver.
36
37
38
39
40
41
42
43
44
45
46
47
48
49
50
51
52
53
54

55 The results of the performance tests are compared in Fig. 15. Several trends
56
57
58

1
2
3
4
5
6
7
8
9 can be observed in this figure. First of all, as might be expected, among the
10 classical DD simulations as the number of replicas and the number of segments
11 increases, the time step increases. Of course, without replica layer the accuracy
12 of the simulations should be called into question, but here the focus is only on
13 the computation times. Then, for the DCM simulation an interesting trend can
14 be observed. At the lowest number of segments, the calculation with the coarsest
15 mesh goes faster, and the one with the finest mesh goes slower. However, going
16 to higher number of segments, this trend is reversed: for the highest number
17 of segments, the calculation with the finest mesh now is the fastest. This rather
18 counter-intuitive result is explained as follows: for a low number of segments,
19 most of the computational burden falls on the resolution of the linear system in the
20 FE part of the DCM, whereas the time to calculate σ^S and σ^{NS} which is the most
21 expensive part in the DD part, of order $O(n_{seg}^2)$, is needed for a relatively few
22 interactions. Normally, at high number of dislocation segments, the computing
23 time will be dominated by the latter part. However, for smaller mesh elements,
24 the regions for which this analytical contribution has to be calculated can be made
25 much smaller (because r_c and r_l are set to scale with h and h_e). Even though the
26 time needed for the resolution of the linear system in the FE part increases, this is
27 more than offset by the decrease in the time to calculate σ^S and σ^{NS} .
28
29
30
31
32
33
34
35
36
37
38
39
40
41
42
43
44

45 It is expected that this advantage will only hold up to a certain mesh refinement
46 and that there is some optimum refinement. It is also expected that this optimum
47 will be very sensitive to the computational performance and scalability of the FE
48 solver. However these numerical problems are outside of the scope of the present
49 article and have not been investigated yet.
50
51
52
53
54

55 Comparing the results of the DCM simulation to the classical DD simulation
56
57
58

1
2
3
4
5
6
7
8
9 with the highest number of segments, it can be seen that the DCM calculation is
10 almost as fast as the fastest classical DD simulation. Interestingly, even though
11 the DCM was originally developed for finite domains, one must realize that in this
12 case the DCM is more precise in periodic domains than the fastest classical DD
13 simulation without replicas, and even faster already when one layer of replicas
14 is taken into account in classical DD simulation. Finally, considering that the
15 FE part essentially carries the long-range interactions (as well as the boundary
16 conditions), it can be considered as an alternative for the multi-pole algorithm,
17 where the cut-off distance between short-range and long-range interactions is now
18 mathematically controlled by r_l .
19
20
21
22
23
24
25
26
27
28

29 **5. Conclusion**

30
31
32 A step forward in the simulation of the dynamical properties of large ensembles of
33 dislocations is achieved. The Discrete-Continuous Model (DCM), which couples
34 a DD and a FE simulation code can now carry out realistic simulations over com-
35 plex domains with large numbers of dislocations. More specifically, a consistent
36 solution for the reconstruction of the short-range interactions has been developed.
37
38 Furthermore, the DCM has been extended to unstructured meshes by adopting
39 new efficient and accurate procedures for the regularisation of the slip by using a
40 tree-based geometric algorithm for fast localisation. Also, a strategy for handling
41 material interfaces or domain boundaries has been proposed. Some other aspects
42 of the DCM, such as the time integration algorithm or the data communications
43 between the two codes have been revised, and the choice of element type (in-
44 terpolation order and number of integration points) has been justified. All these
45 modifications lead to very significant gains in precision and speed.
46
47
48
49
50
51
52
53
54
55
56
57
58

1
2
3
4
5
6
7
8
9 Ongoing calculations, to be published in a companion article, show that the
10 progress made in the DCM method now allows for new types of simulations such
11 as:
12
13

- 14
15 • *Anisotropic elasticity simulation.* In the particular case of structures for
16 which a sufficiently refined mesh can be used (currently typically a few
17 hundred nanometers) it is now possible to run DCM simulations without
18 using the short-range stress field correction in the DD simulation code.
19
20
- 21 • *Simulation of small micro-samples and micro-structured materials.* The
22 flexibility of the new DCM method allows modelling plastic size effects in
23 materials with very complex boundaries and loading conditions. In short, it
24 is now possible to track any problem that can be set up with a conventional
25 small-strain FE method.
26
27
- 28 • *Simulation of poly-crystalline or multi-domain microstructures.* Multi-method
29 simulations can be run with the DCM where the plastic deformation is cal-
30 culated in a particular region with dislocation dynamics and in other regions
31 with continuum constitutive laws.
32
33
34
35
36
37
38
39
40
41
42
43

44 **Acknowledgments**

45
46 The support of the research project Mera-FASS is acknowledged.
47
48
49

50 **References**

- 51
52
53 [1] J. P. Hirth, J. Lothe, Theory of Dislocations, MacGraw-Hill, New York,
54 1982.
55
56
57
58

- 1
2
3
4
5
6
7
8
9 [2] B. Devincre, Three dimensional stress field expressions for straight dislocation segments, *Solid State Communications* 93 (1995) 875.
10
11
12
13
14 [3] W. Cai, A. Arsenlis, C. Weinberger, V. Bulatov, A non-singular continuum theory of dislocations, *Journal of the Mechanics and Physics of Solids* 54 (2006) 561–587.
15
16
17
18
19
20 [4] B. Devincre, A. Roos, S. Groh, Boundary problems in DD simulations, in: A. Finel, D. Mazière, M. Véron (Eds.), *Thermodynamics, Microstructures and Plasticity*, NATO Science Series, Kluwer Academic Publishers, Dordrecht, 2003, pp. 275–284.
21
22
23
24
25
26
27
28
29 [5] E. Van der Giessen, A. Needleman, Discrete dislocation plasticity: a simple planar model, *Modelling and Simulation in Materials Science and Engineering* 3 (1995) 689.
30
31
32
33
34
35
36 [6] M. Fivel, G. R. Canova, Developing rigorous boundary conditions to simulations of discrete dislocation dynamics, *Modelling Simul. Mater. Sci. Eng.* 7 (1999) 753–768.
37
38
39
40
41
42 [7] H. M. J. Zbib, T. Diaz de la Rubia, A multiscale model of plasticity, *International Journal of Plasticity* 18 (2002) 1133–1163.
43
44
45
46
47 [8] D. Weygand, L. H. Friedman, E. van der Giessen, Aspect of boundary-value problem solutions with 3D dislocation dynamics, *Modelling Simul. Mater. Sci. Eng.* 10 (2002) 437–468.
48
49
50
51
52
53 [9] M. Tang, W. Cai, G. Xu, V. V. Bulatov, A hybrid method for computing forces on curved dislocations intersecting free surfaces in three-dimensional
54
55
56
57
58

1
2
3
4
5
6
7
8
9 dislocation dynamics, *Modelling and Simulation in Materials Science and*
10 *Engineering* 14 (2006) 1139–1151.

11
12
13
14 [10] K. W. Leiter, J. C. Crone, J. Knap, An algorithm for massively parallel
15 dislocation dynamics simulations of small scale plasticity, *Journal of Com-*
16 *putational Science* 4 (2013) 401–411.

17
18
19
20 [11] C. R. Weinberger, W. Cai, Computing image stress in an elastic cylinder,
21 *Journal of the Mechanics and Physics of Solids* 55 (2007) 2027–2054.

22
23
24 [12] J. A. El-Awady, S. Bulent Biner, N. M. Ghoniem, A self-consistent bound-
25 ary element, parametric dislocation dynamics formulation of plastic flow in
26 finite volumes, *Journal of the Mechanics and Physics of Solids* 56 (2008)
27 2019–2035.

28
29
30
31 [13] A. Takahashi, N. M. Ghoniem, A computational method for dislocation-
32 precipitate interaction, *Journal of the Mechanics and Physics of Solids* 56
33 (2008) 1534–1553.

34
35
36
37 [14] C. R. Weinberger, S. Aubry, S.-W. Lee, W. D. Nix, W. Cai, Modelling
38 dislocations in a free-standing thin film, *Modelling Simul. Mater. Sci. Eng.*
39 17 (2009) 075007.

40
41
42
43 [15] S. Akarapu, H. M. Zbib, D. F. Bahr, Analysis of heterogeneous deformation
44 and dislocation dynamics in single crystal micropillars under compression,
45 *International Journal of Plasticity* 26 (2010) 239–257.

46
47
48
49 [16] J. A. El-Awady, S. I. Rao, C. Woodward, D. M. Dimiduk, M. D. Uchic, Trap-
50 ping and escape of dislocations in micro-crystals with external and internal
51 barriers, *International Journal of Plasticity* 27 (2011) 372–387.

- 1
2
3
4
5
6
7
8
9 [17] C. Zhou, R. LeSar, Dislocation dynamics simulations of plasticity in poly-
10 crystalline thin films, *International Journal of Plasticity* 30–31 (2012) 185–
11 201.
12
13
14
15 [18] J. C. Crone, P. W. Chung, K. W. Leiter, J. Knap, S. Aubry, G. Hommes,
16 A. Arsenlis, A multiply parallel implementation of finite element-based dis-
17 crete dislocation dynamics for arbitrary geometries, *Modelling and Simula-
18 tion in Materials Science and Engineering* 22 (2014) 035014.
19
20
21 [19] C. Lemarchand, B. Devincre, L. P. Kubin, J. L. Chaboche, Coupled meso-
22 macro simulations of plasticity: Validation tests, in: V. Bulatov, T. Diaz de la
23 Rubia, T. Phillips, R. and Kaxiras, N. Ghoniem (Eds.), *Multiscale Modelling
24 of Materials*, volume 538, MRS, Warrendale, Pennsylvania, 1999, pp. 63–
25 68.
26
27
28 [20] C. Lemarchand, B. Devincre, L. Kubin, Homogenization method for a
29 discrete-continuum simulation of dislocation dynamics, *J. Mech. Phys.
30 Solids* 49 (2001) 1969.
31
32
33 [21] Z. L. Liu, X. M. Liu, Z. Zhuang, X. C. You, A multi-scale computational
34 model of crystal plasticity at submicron-to-nanometer scales, *International
35 Journal of Plasticity* 25 (2009) 1436–1455.
36
37
38 [22] A. Vattré, B. Devincre, F. Feyel, R. Gatti, S. Groh, O. Jamond, A. Roos,
39 Modelling crystal plasticity by 3d dislocation dynamics and the finite ele-
40 ment method: The discrete-continuous model revisited, *Journal of the Me-
41 chanics and Physics of Solids* 63 (2014) 491–505.
42
43
44
45
46
47
48
49
50
51
52
53
54
55
56
57
58
59
60
61
62
63
64
65

- 1
2
3
4
5
6
7
8
9 [23] Y. Cui, Z. Liu, Z. Zhuang, Quantitative investigations on dislocation based
10 discrete-continuous model of crystal plasticity at submicron scale, *International Journal of Plasticity* 69 (2015) 54–72.
11
12
13
14
15 [24] T. Mura, *Micromechanics of Defects in Solids*, Kluwer Academic Publishers,
16 Dordrecht (The Netherlands), 1991.
17
18
19 [25] S. Groh, B. Devincere, L. Kubin, A. Roos, F. Feyel, J.-L. Chaboche, Disloca-
20 tions and elastic anisotropy in heteroepitaxial metallic thin films, *Phil. Mag.*
21 *Letters* 83 (2003) 303–313.
22
23
24
25 [26] Z. L. Liu, Z. Zhuang, X. M. Liu, X. C. Zhao, Z. H. Zhang, A dislocation
26 dynamics based higher-order crystal plasticity model and applications on
27 confined thin-film plasticity, *International Journal of Plasticity* 27 (2011)
28 201–216.
29
30
31
32
33 [27] S. Groh, B. Devincere, L. Kubin, A. Roos, F. Feyel, J.-L. Chaboche, Size
34 effects in metal matrix composites, *Materials Science and Engineering A*
35 400–401 (2005) 279–282.
36
37
38
39 [28] A. Vattré, B. Devincere, A. Roos, Orientation dependence of plastic deforma-
40 tion in nickel-based single crystal superalloys: Discrete-continuous model
41 simulations, *Acta Materialia* 58 (2010) 1938–1951.
42
43
44
45 [29] S. Groh, B. Devincere, F. Feyel, L. Kubin, A. Roos, J.-L. Chaboche, Discrete-
46 continuum modeling of metal matrix composites plasticity, in: H. Kitagawa,
47 Y. Shibutani (Eds.), *IUTAM Symposium on Mesoscopic Dynamics of Frac-
48 ture Process and Materials Strength*, volume 115 of *Solid Mechanics and its
49 Applications*, Kluwer Academic Publishers, NL-Dordrecht, 2004.
50
51
52
53
54
55
56
57
58

- 1
2
3
4
5
6
7
8
9 [30] B. Devincre, R. Madec, G. Monnet, S. Queyreau, R. Gatti, L. Kubin, *Mechanics of Nano-objects*, Presses de l’Ecole des Mines de Paris, 2011.
10
11
12
13
14 [31] Z-set — non-linear material and structure analysis suite, 2015. URL:
15 <http://www.zset-software.com>.
16
17
18 [32] J. Carrier, L. Greengard, V. Rokhlin, A fast adaptive multipole algorithm for
19 particle simulations, *SIAM Journal on Scientific and Statistical Computing*
20 9 (1988) 669–686.
21
22
23
24 [33] H. Wang, R. LeSar, $O(n)$ algorithm for dislocation dynamics, *Philosophical*
25 *Magazine A* 71 (1995) 149–164.
26
27
28
29 [34] J. Yin, D. M. Barnett, S. P. Fitzgerald, W. Cai, Computing dislocation stress
30 fields in anisotropic elastic media using fast multipole expansions, *Mod-*
31 *elling and Simulation in Materials Science and Engineering* 20 (2012).
32
33
34
35 [35] R. B. Sills, W. Cai, Efficient time integration in dislocation dynamics,
36 *Modelling and Simulation in Materials Science and Engineering* 22 (2014)
37 025003.
38
39
40
41 [36] J. Bentley, J. Friedman, Data structures for range searching, *ACM Comput-*
42 *ing Surveys (CSUR)* 11 (1979) 397–409.
43
44
45
46 [37] P. Agarwal, J. Erickson, Geometric range searching and its relatives, *Con-*
47 *temporary Mathematics* 223 (1999) 1–56.
48
49
50
51
52
53
54
55
56
57
58
59
60
61
62
63
64
65

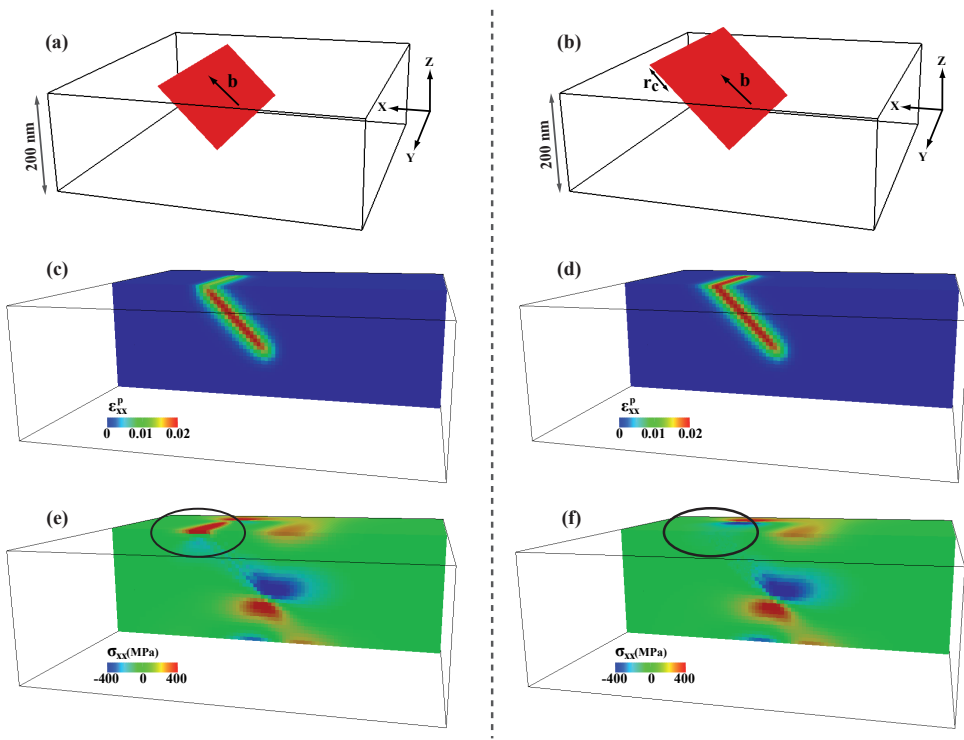

Figure 7: Application of the two strategies illustrated in Fig. 6 to the the problem of a dislocation loop emerging at a free surface. In this example $h = 30$ nm, $r_c = 1.75h$, $b = 0.25$ nm and isotropic elastic constant are used, with shear modulus $\mu = 51$ GPa and Poisson ratio $\nu = 0.37$. (a) and (b) are the two swept areas corresponding to the strategy 1 or 2. (c) and (d) are the corresponding eigenstrain field distributions. (e) and (f) are the σ_{xx} stress components calculated with the different strategies. Note the presence of artificial stresses at the surface of the solution (e).

1
2
3
4
5
6
7
8
9
10
11
12
13
14
15
16
17
18
19
20
21
22
23
24
25
26
27
28
29
30
31
32
33
34
35
36
37
38
39
40
41
42
43
44
45
46
47
48
49
50
51
52
53
54
55
56
57
58
59
60
61
62
63
64
65

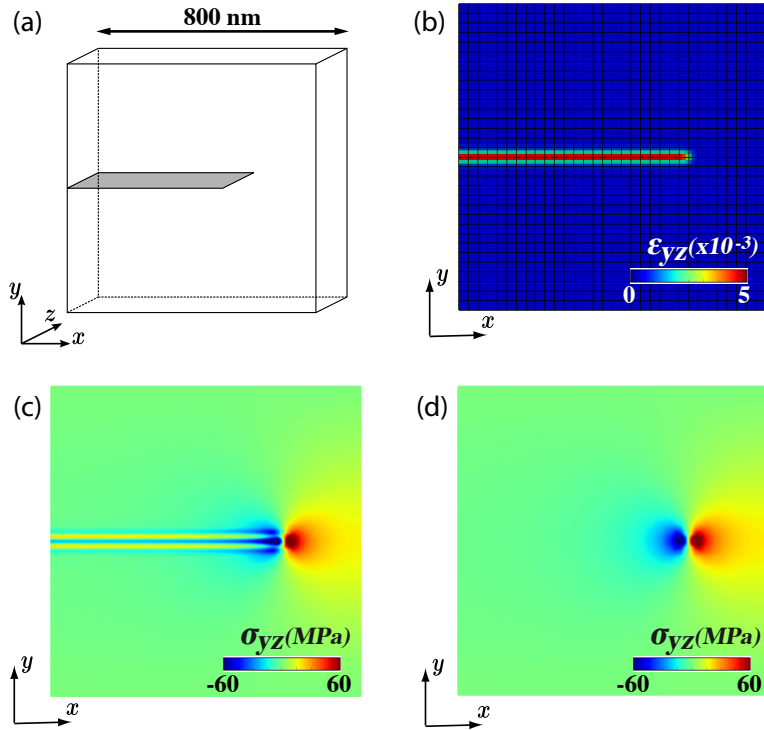

Figure 8: Finite element test aiming at reproducing the stress field of a single screw dislocation using the eigenstrain theory and the regularisation procedure of swept areas presented in paragraph 2.2. The swept area is shown in a), the resulting component of the eigenstrain ϵ_{yz}^p and the $32 \times 32 \times 4$ mesh in b), σ_{yz}^{FE} computed with 20-node and 27-IP elements in c) and σ_{yz}^{FE} computed with 20-node and 8-IP elements in d).

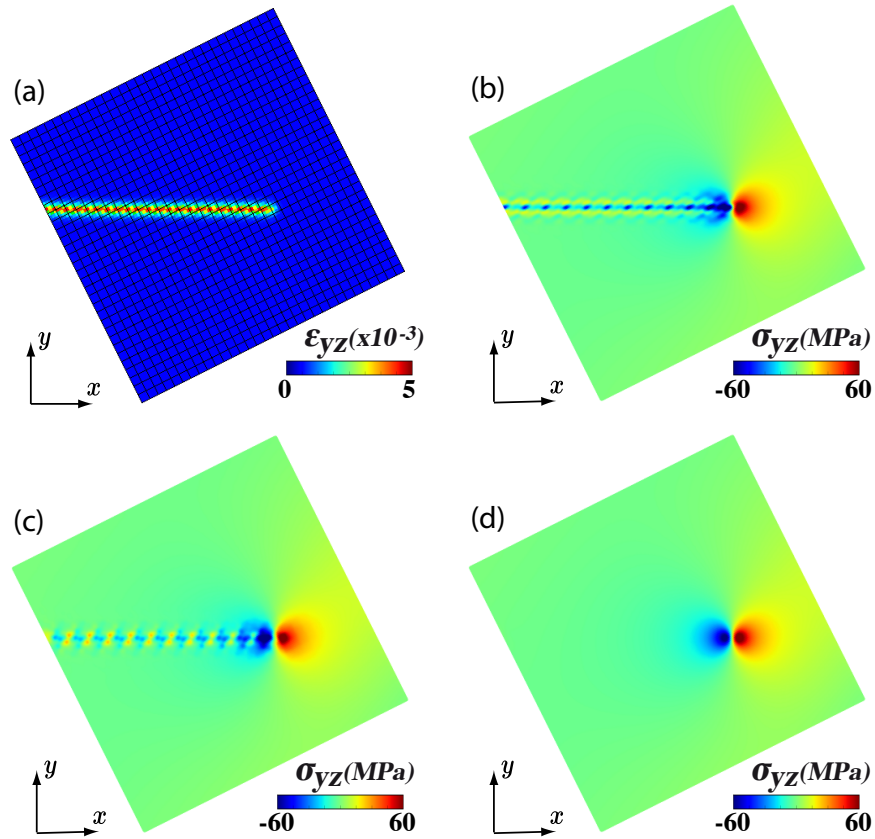

Figure 9: Same test as in Fig. 8 but with a mesh rotated with respect to the slipped area. ϵ_{yz}^p and the mesh are given in a), σ_{yz}^{FE} computed with 20-node, 27-IP elements in b), σ_{yz}^{FE} computed with 20-node, 8-IP elements in c) and σ_{yz}^{FE} computed with 20-node, 8-IP elements with a finer mesh (4 elements across h) in d).

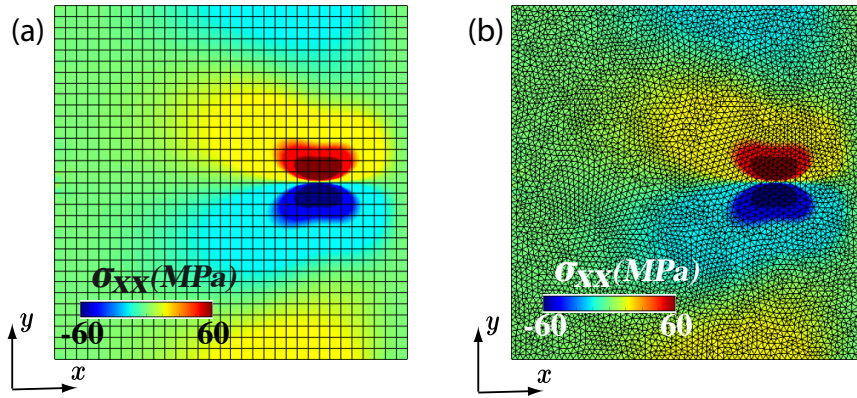

Figure 10: Comparison of σ_{xx}^{FE} components computed with (a) a structured mesh made of 20-node, 8-IP hexaedron elements and (b) an unstructured mesh made of 10-node, 4-IP tetrahedron elements. Both results correspond to the same configuration as shown in Fig. 8.

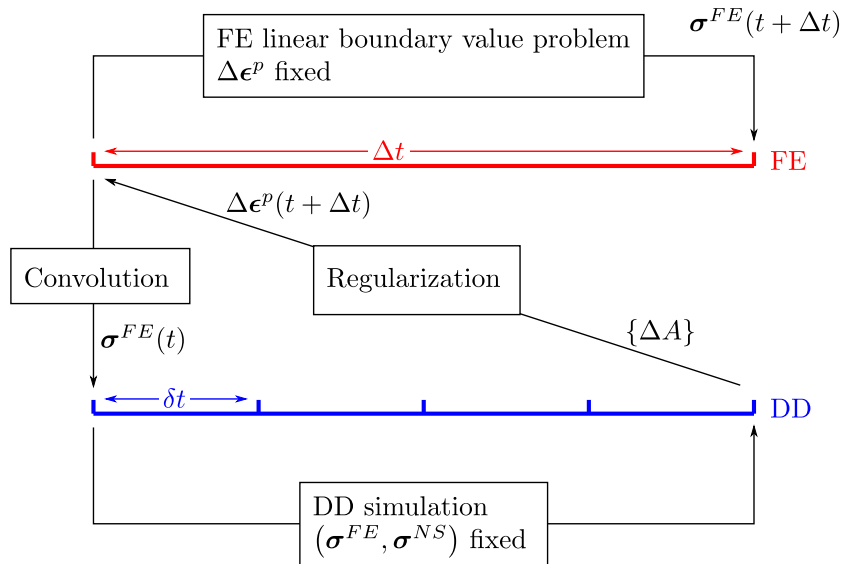

Figure 11: DCM: time integration algorithm.

1
2
3
4
5
6
7
8
9
10
11
12
13
14
15
16
17
18
19
20
21
22
23
24
25
26
27
28
29
30
31
32
33
34
35
36
37
38
39
40
41
42
43
44
45
46
47
48
49
50
51
52
53
54
55
56
57
58
59
60
61
62
63
64
65

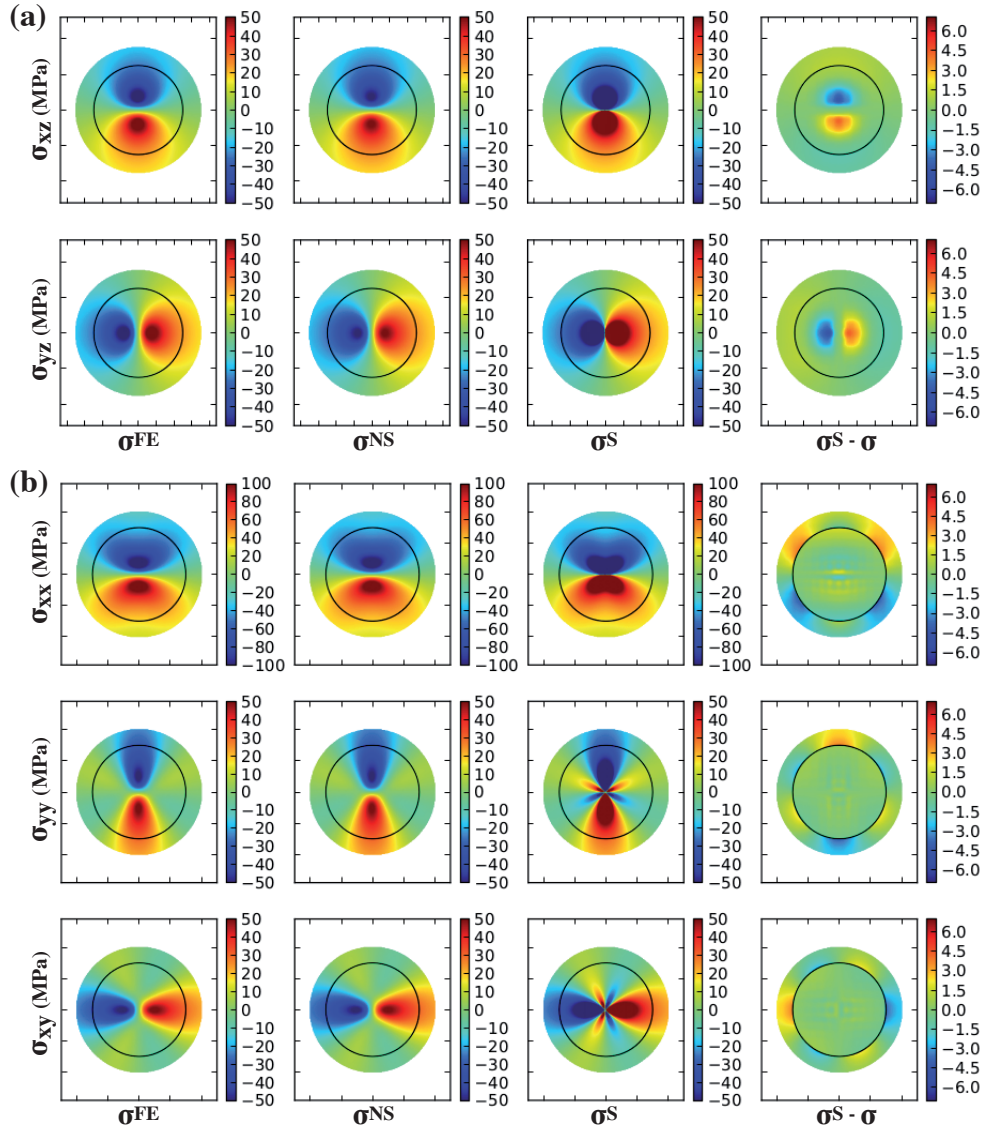

Figure 12: Non-zero components of the stress fields σ^{FE} , σ^{NS} , σ^S and of the absolute error $\sigma - \sigma^S$ around the core of a straight, infinitely long (a) screw, and (b) edge dislocation. The black circle delimits the local correction area at $r_l \approx L/16$ around the dislocation core.

1
2
3
4
5
6
7
8
9
10
11
12
13
14
15
16
17
18
19
20
21
22
23
24
25
26
27
28
29
30
31
32
33
34
35
36
37
38
39
40
41
42
43
44
45
46
47
48
49
50
51
52
53
54
55
56
57
58
59
60
61
62
63
64
65

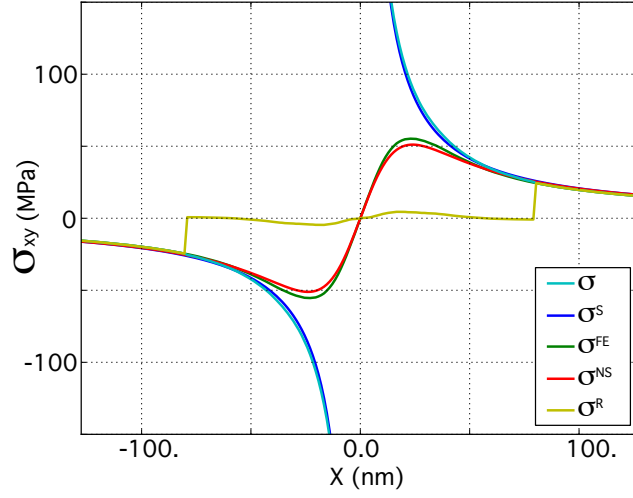

Figure 13: (a) σ_{xy} components of σ , σ^S , σ^{FE} , σ^{NS} and σ^R along the x -axis for the infinitely long straight screw dislocation.

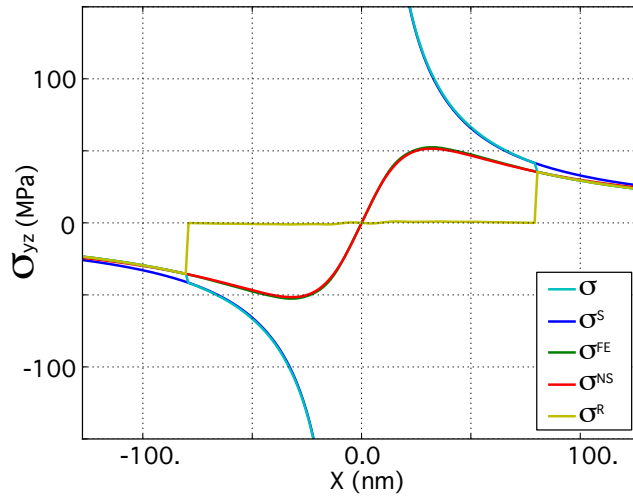

Figure 14: (a) σ_{yz} components of σ , σ^S , σ^{FE} , σ^{NS} and σ^R along the x -axis for the infinitely long straight edge dislocation.

1
2
3
4
5
6
7
8
9
10
11
12
13
14
15
16
17
18
19
20
21
22
23
24
25
26
27
28
29
30
31
32
33
34
35
36
37
38
39
40
41
42
43
44
45
46
47
48
49
50
51
52
53
54
55
56
57
58
59
60
61
62
63
64
65

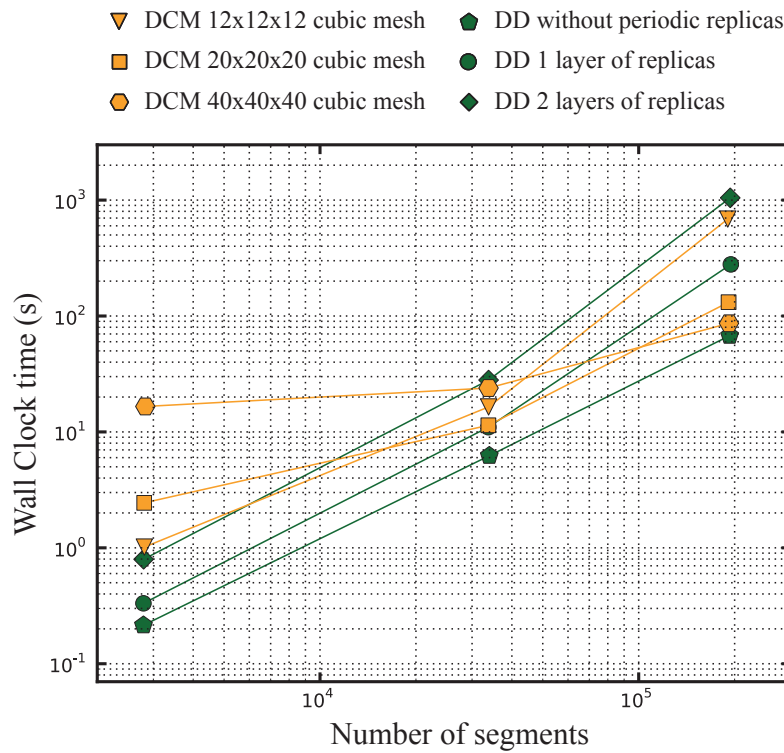
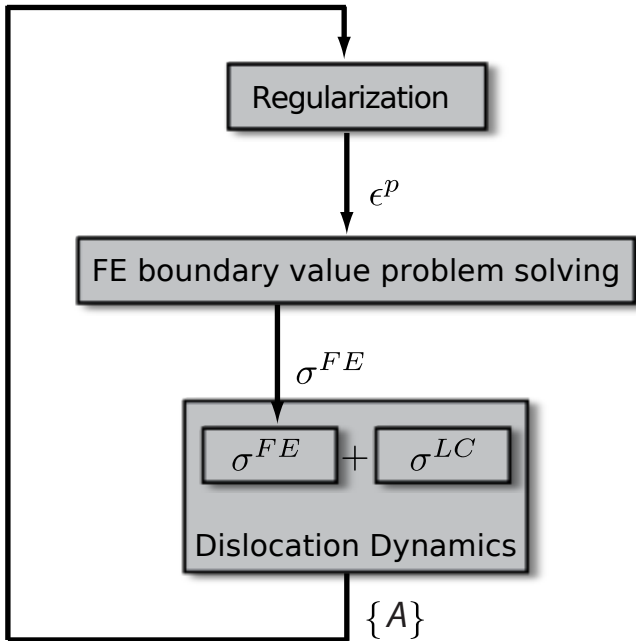
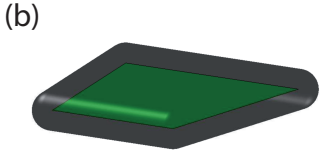
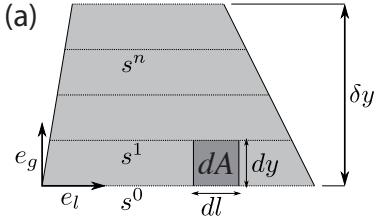
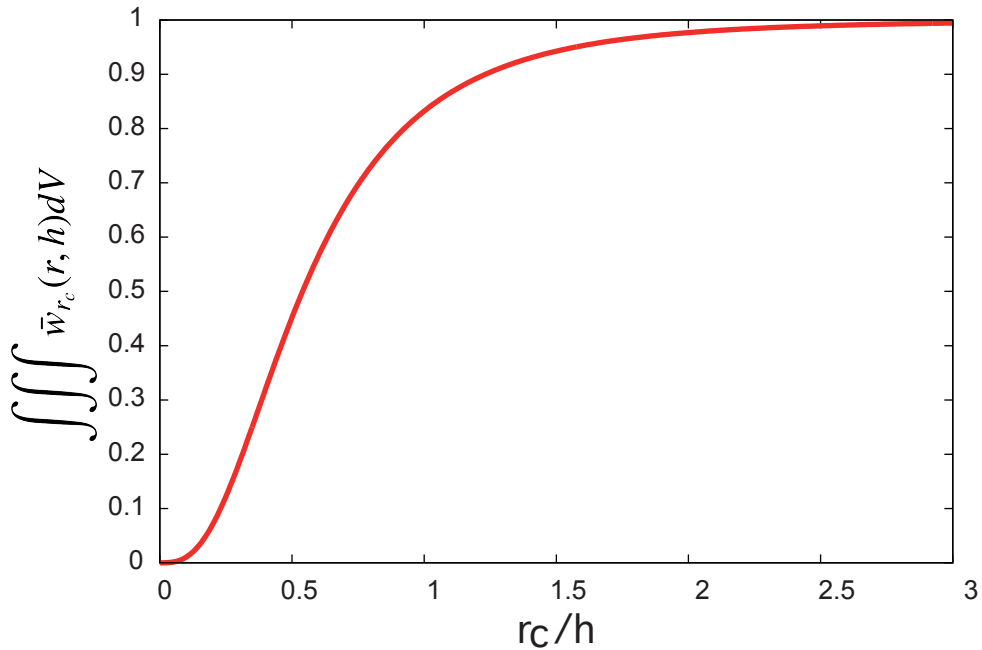

Figure 15: Performance tests (wall clock time per time step $\Delta t = \delta t$ as a function of the number of segments n_{seg} in the simulation). In the DCM simulations (yellow symbols) three different mesh refinements were used and in the classical DD simulations (green symbols) the number of layers of replicas around the simulation cell increased from 0 to 2.







Figure

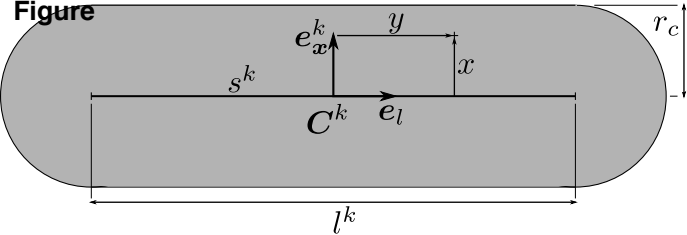

Figure

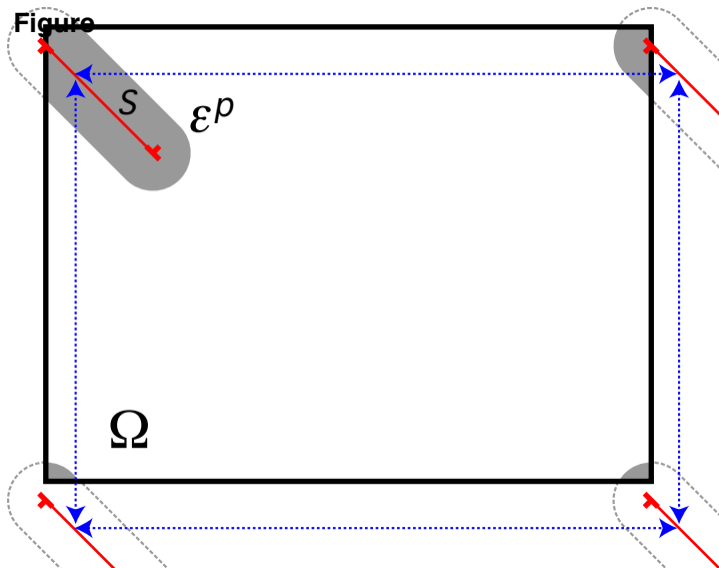

Figure

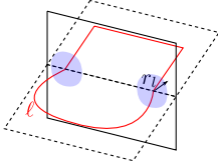
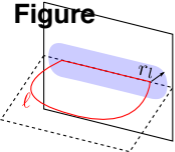

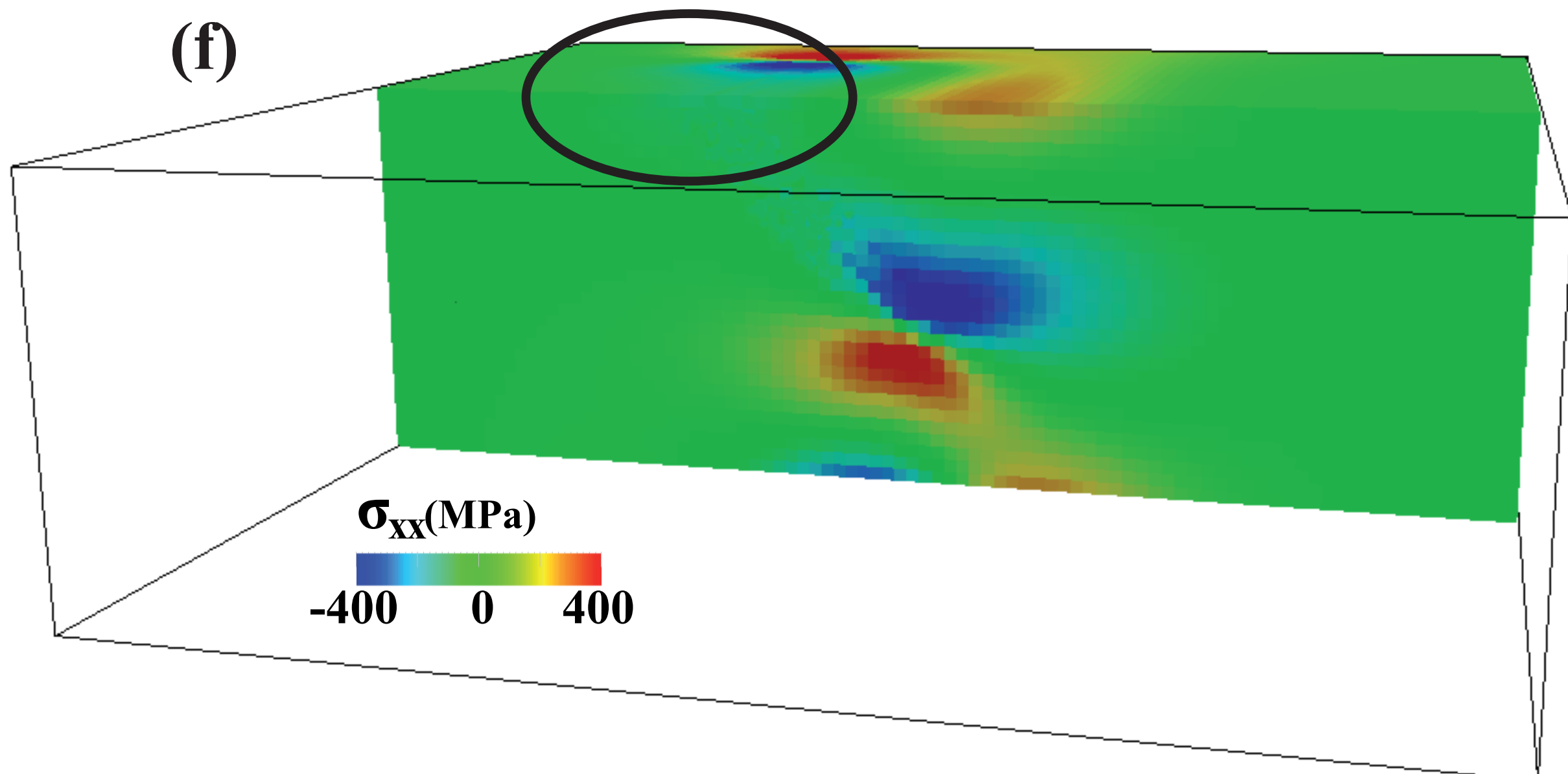
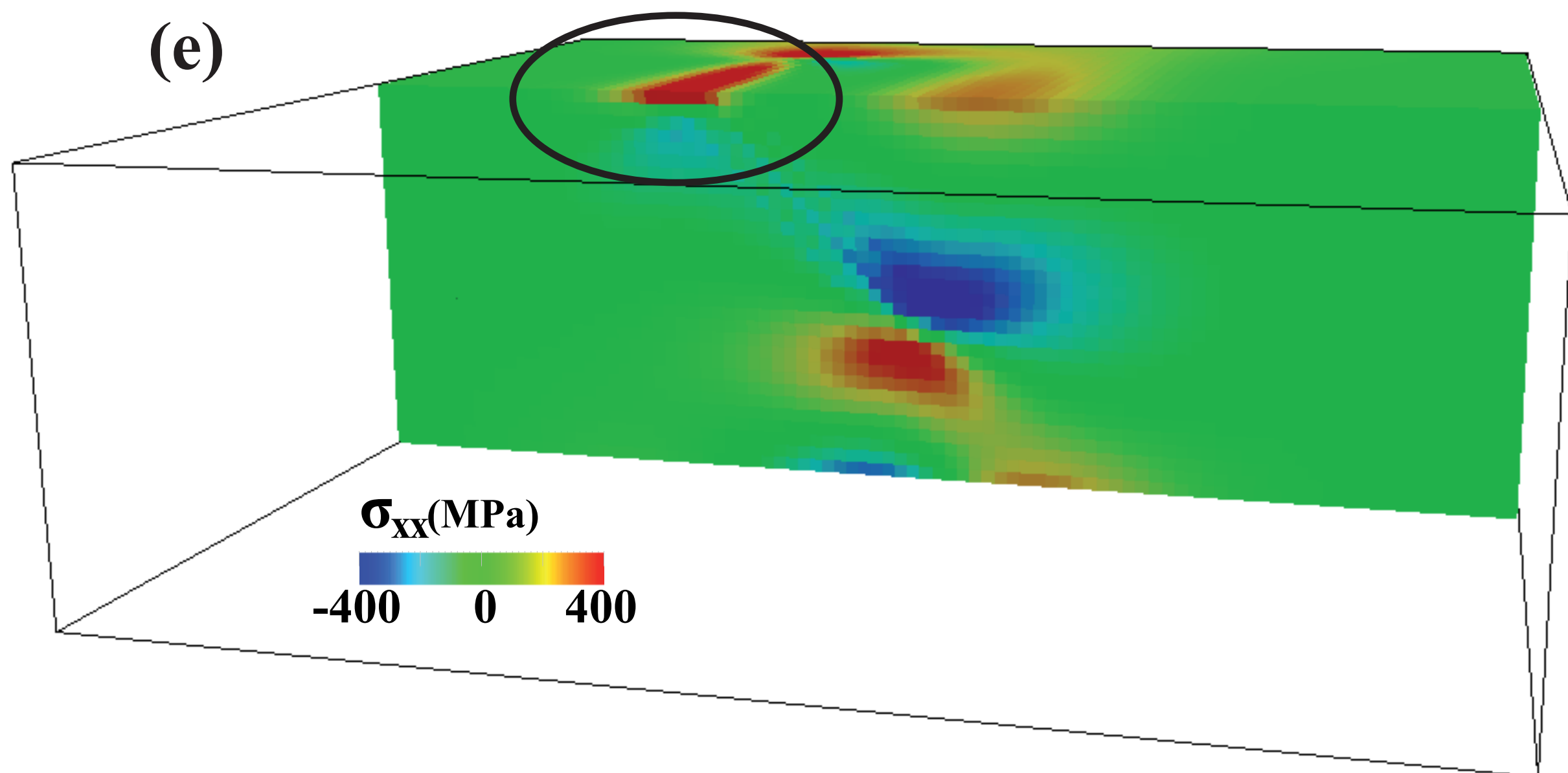
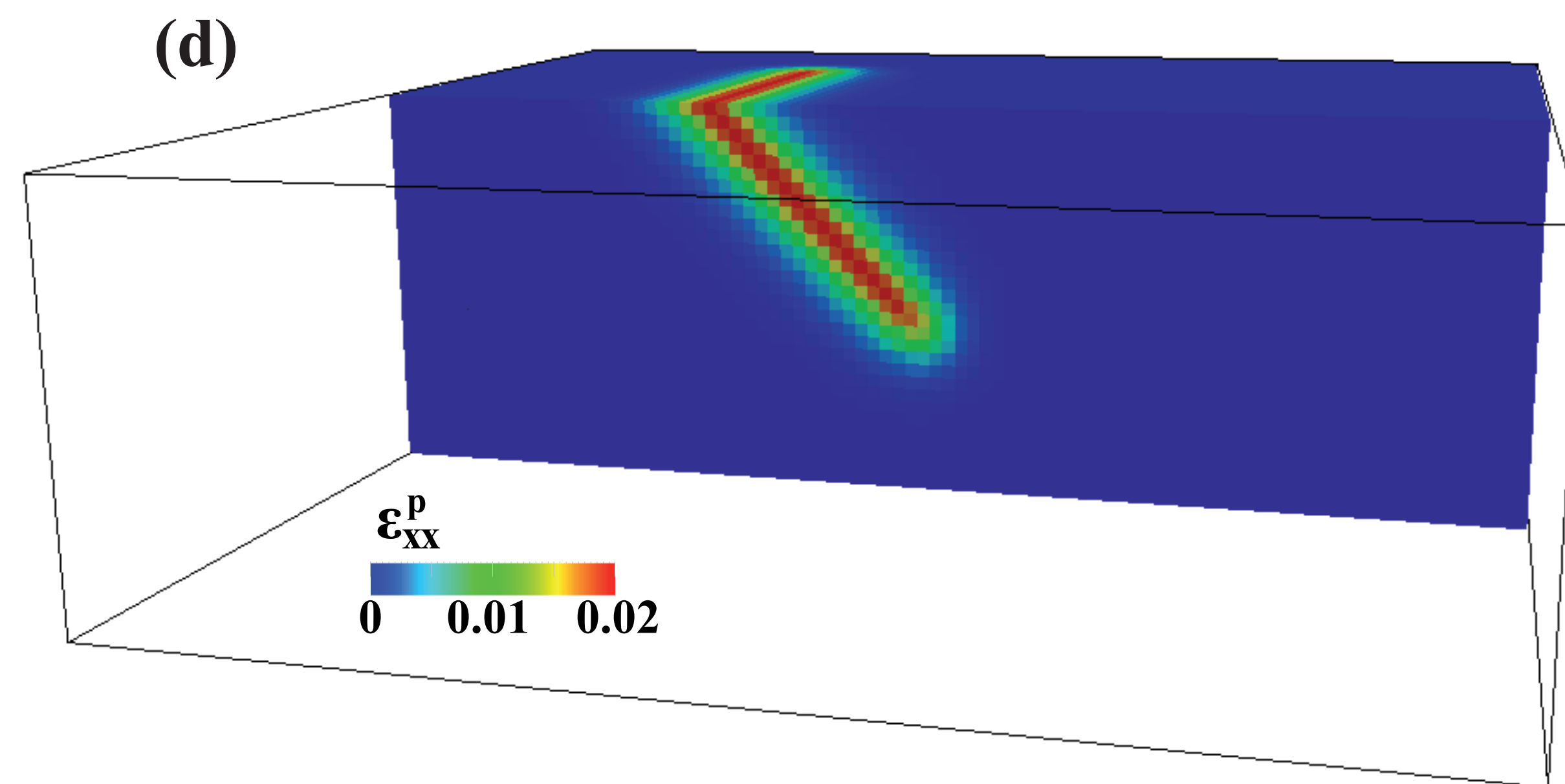
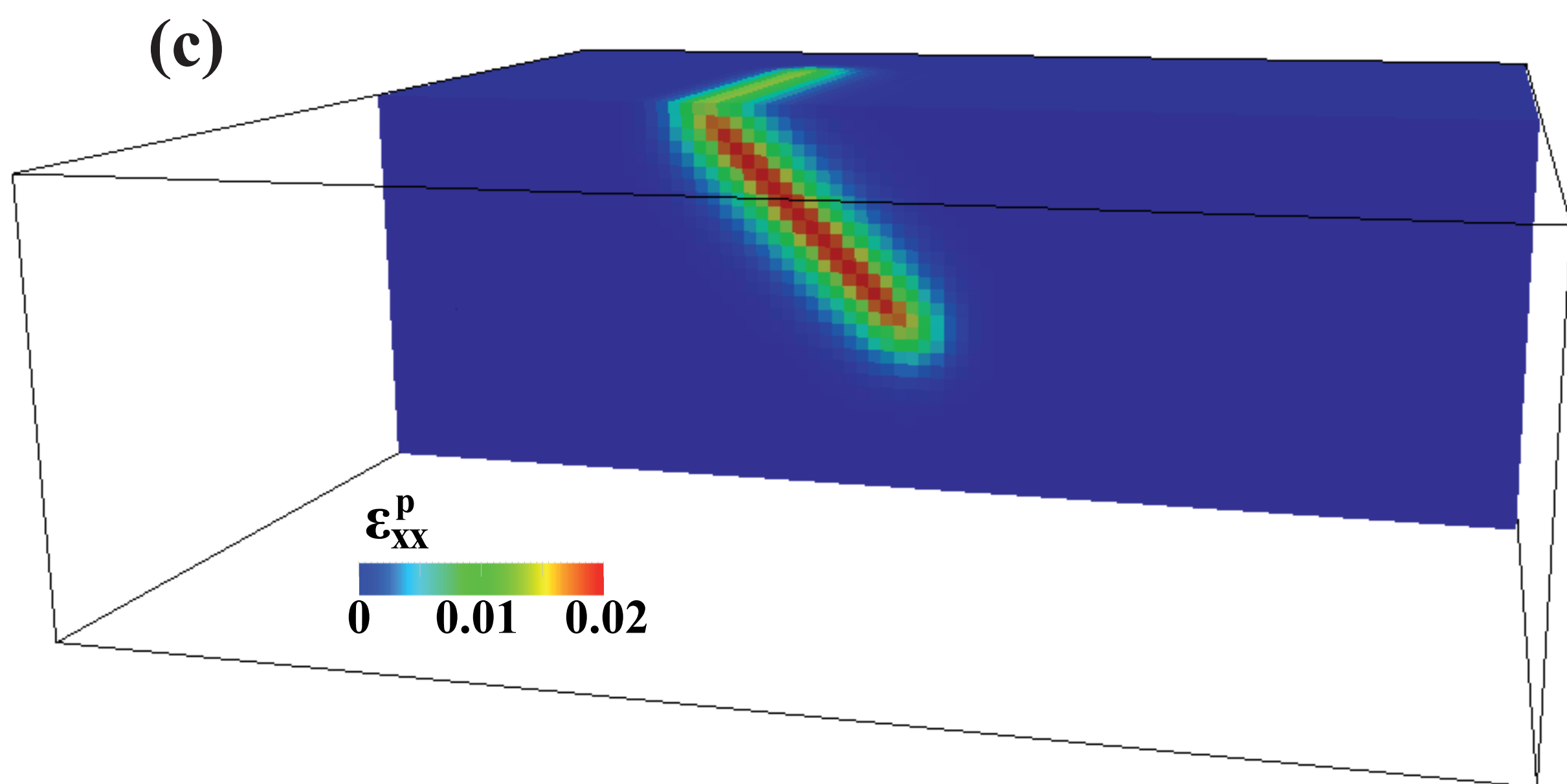
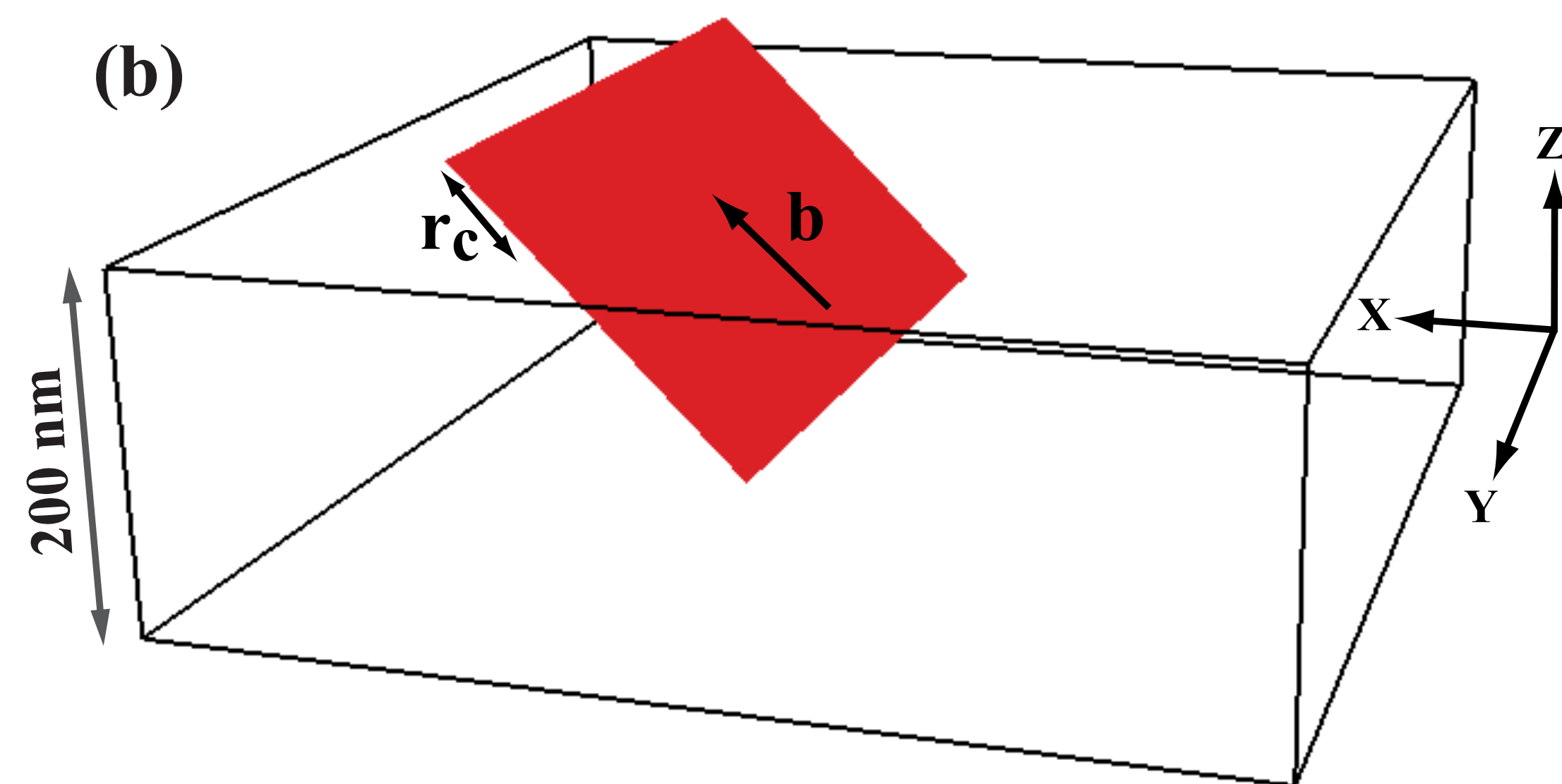
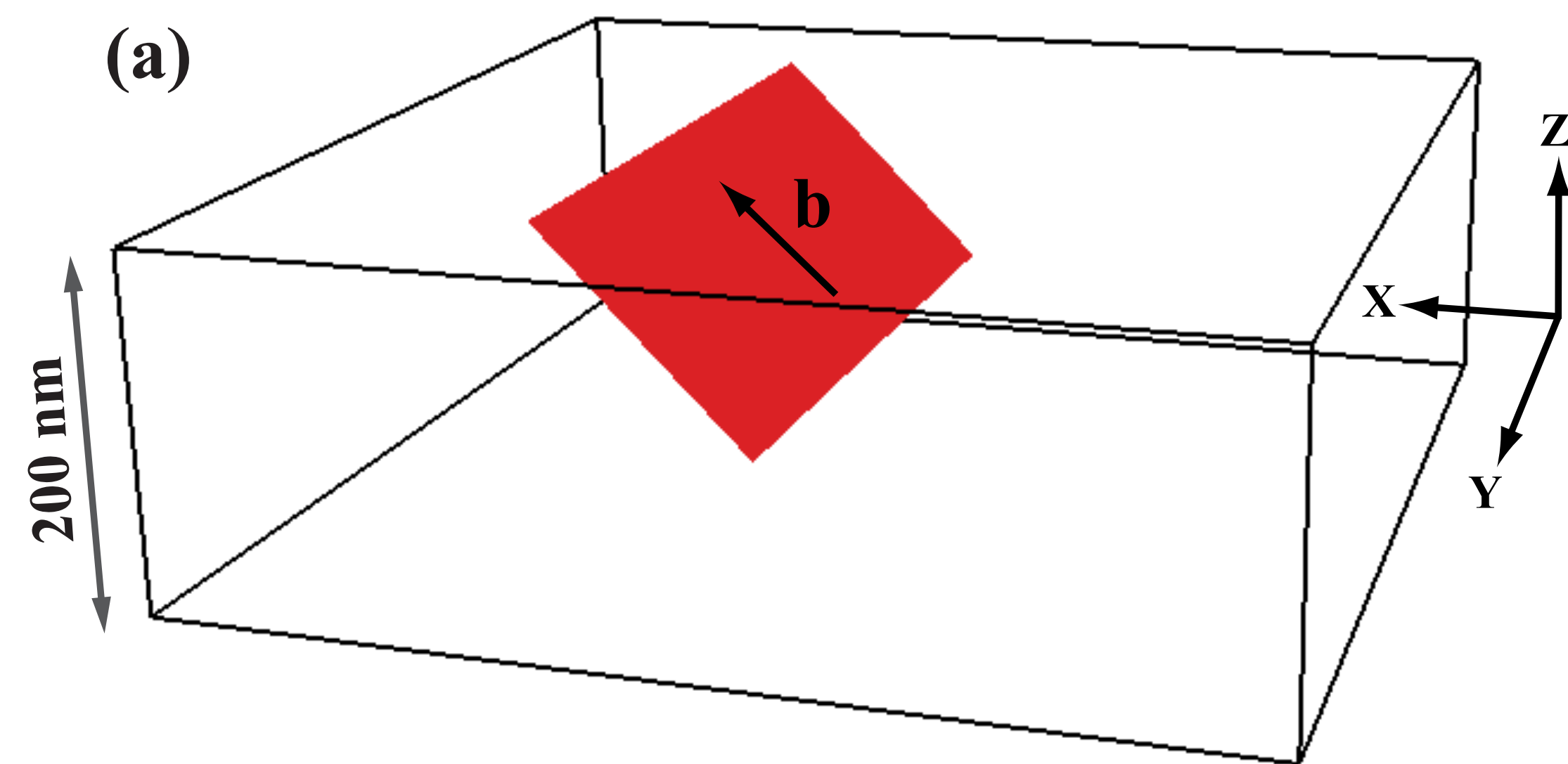

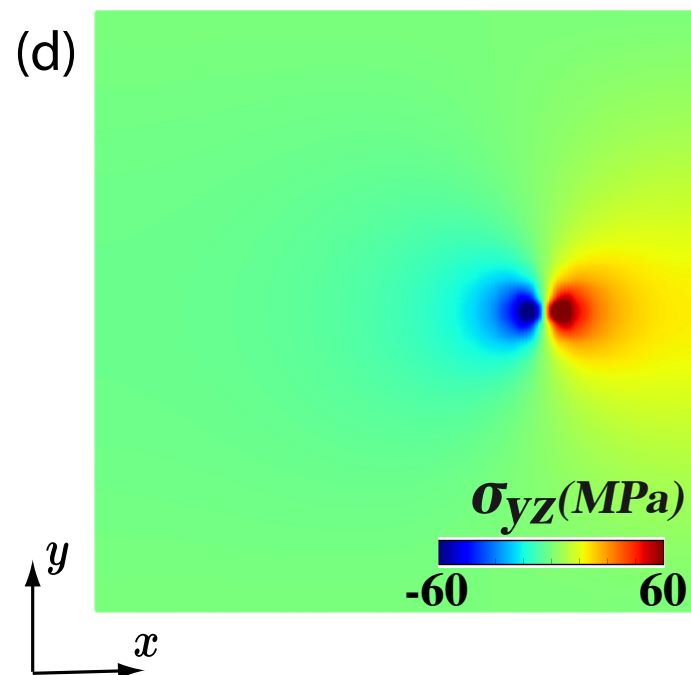
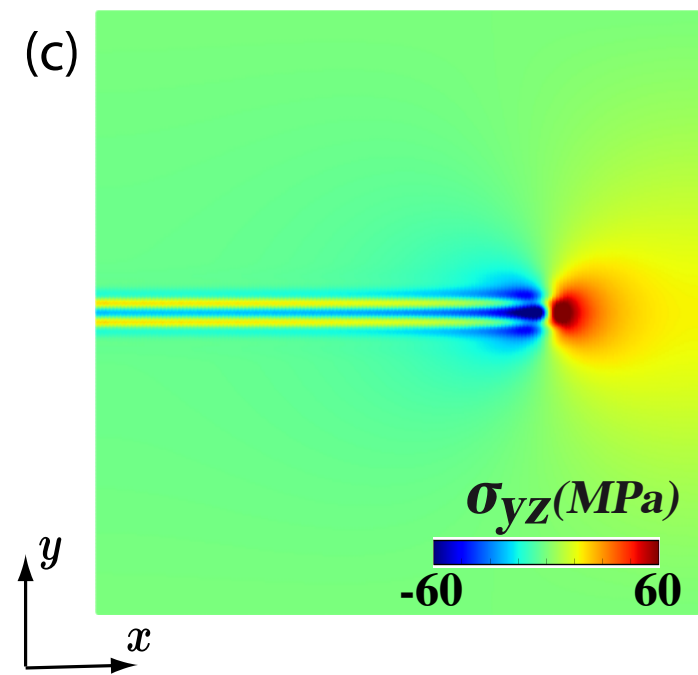
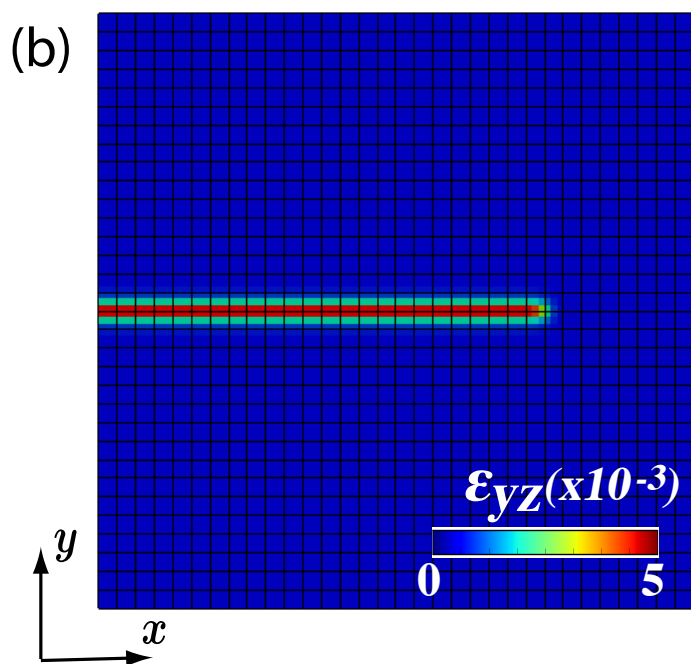
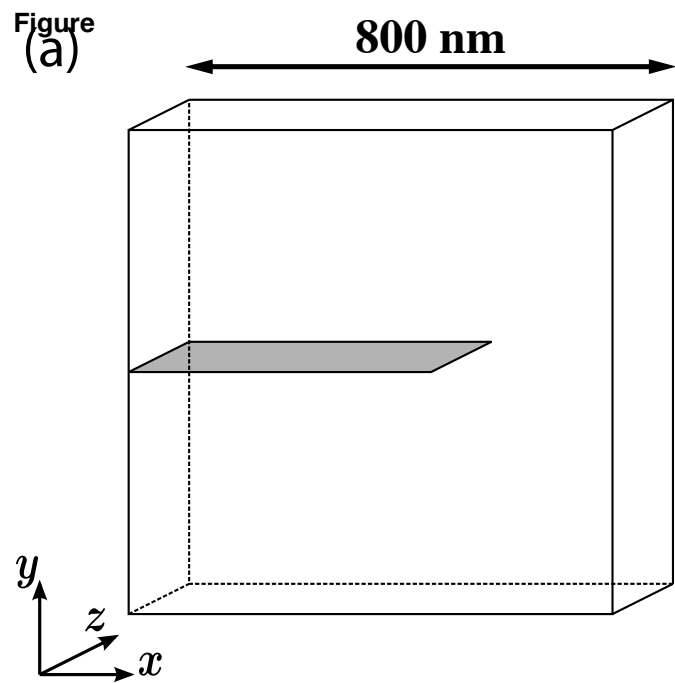

Figure

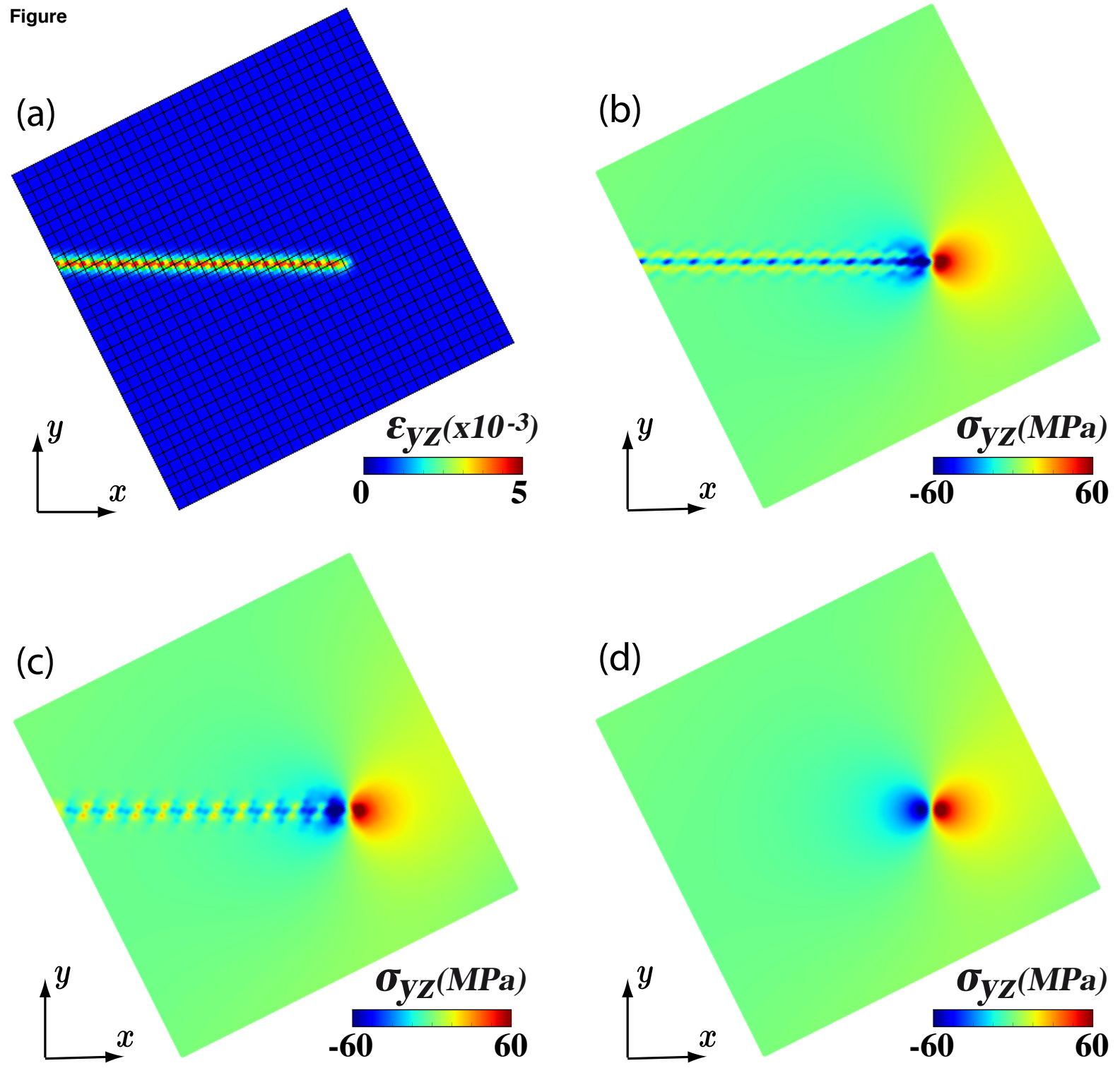

Figure

(a)

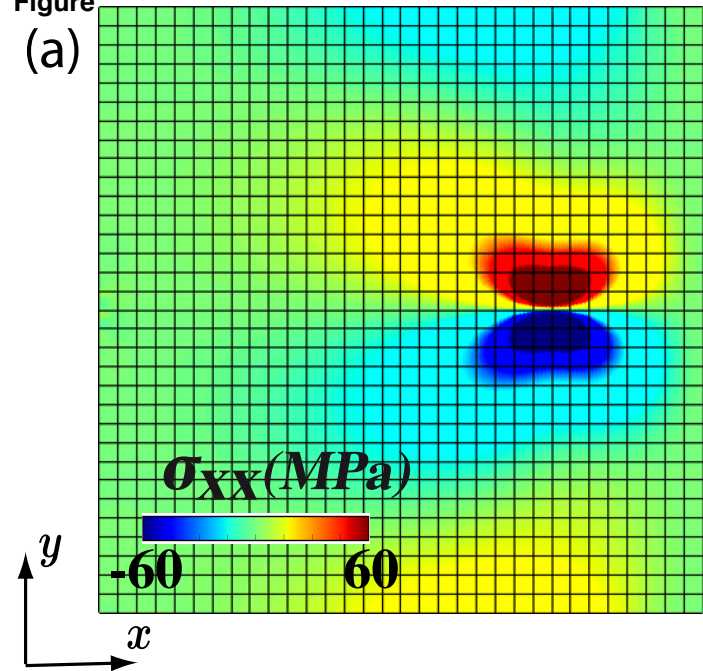

(b)

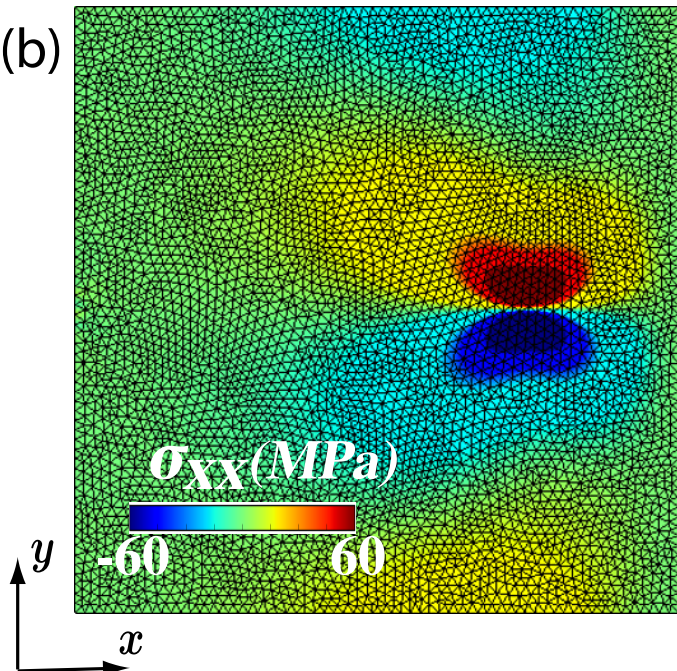

Figure

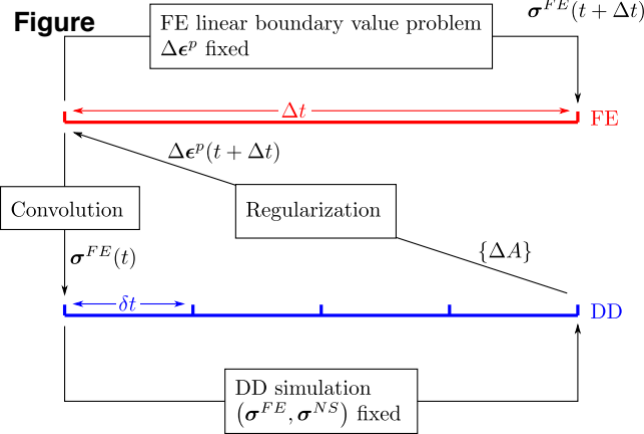

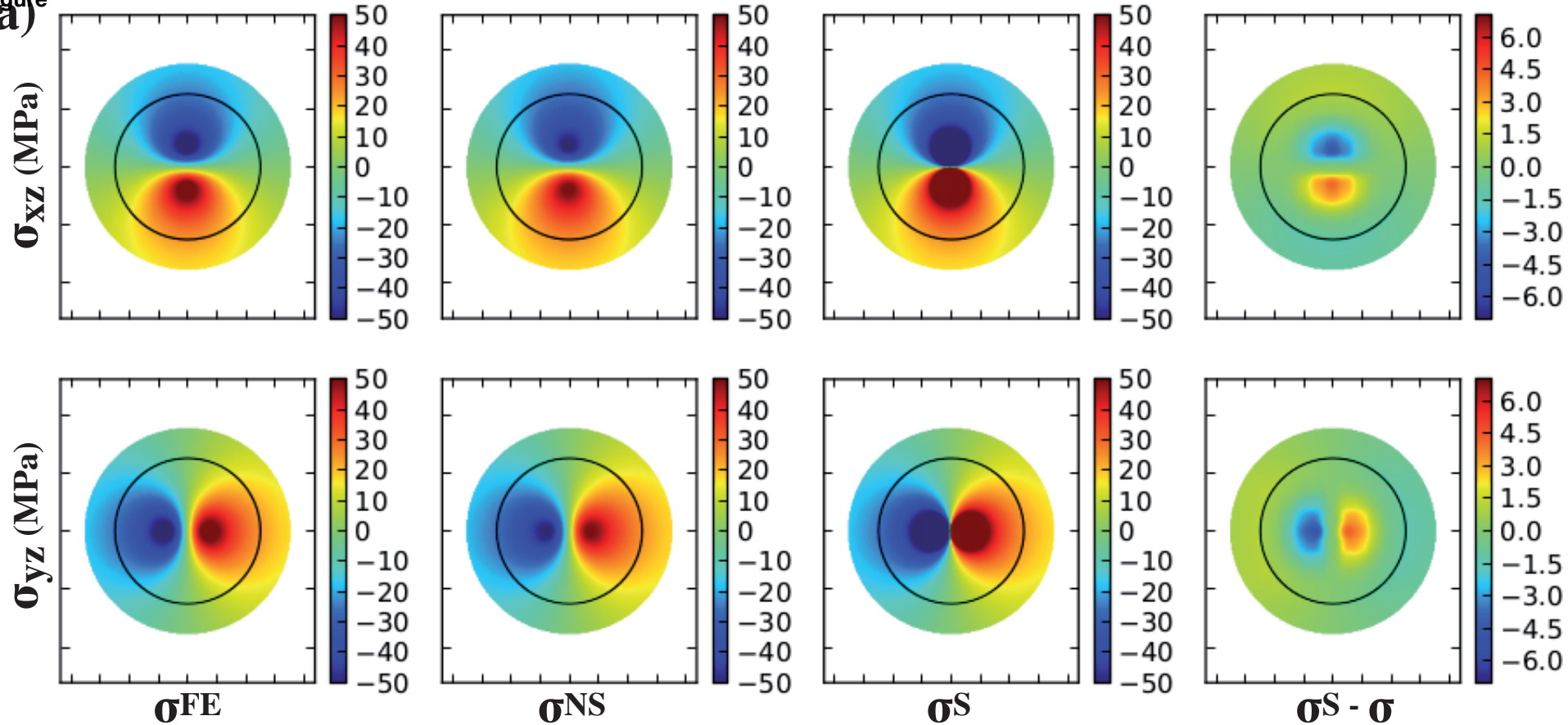
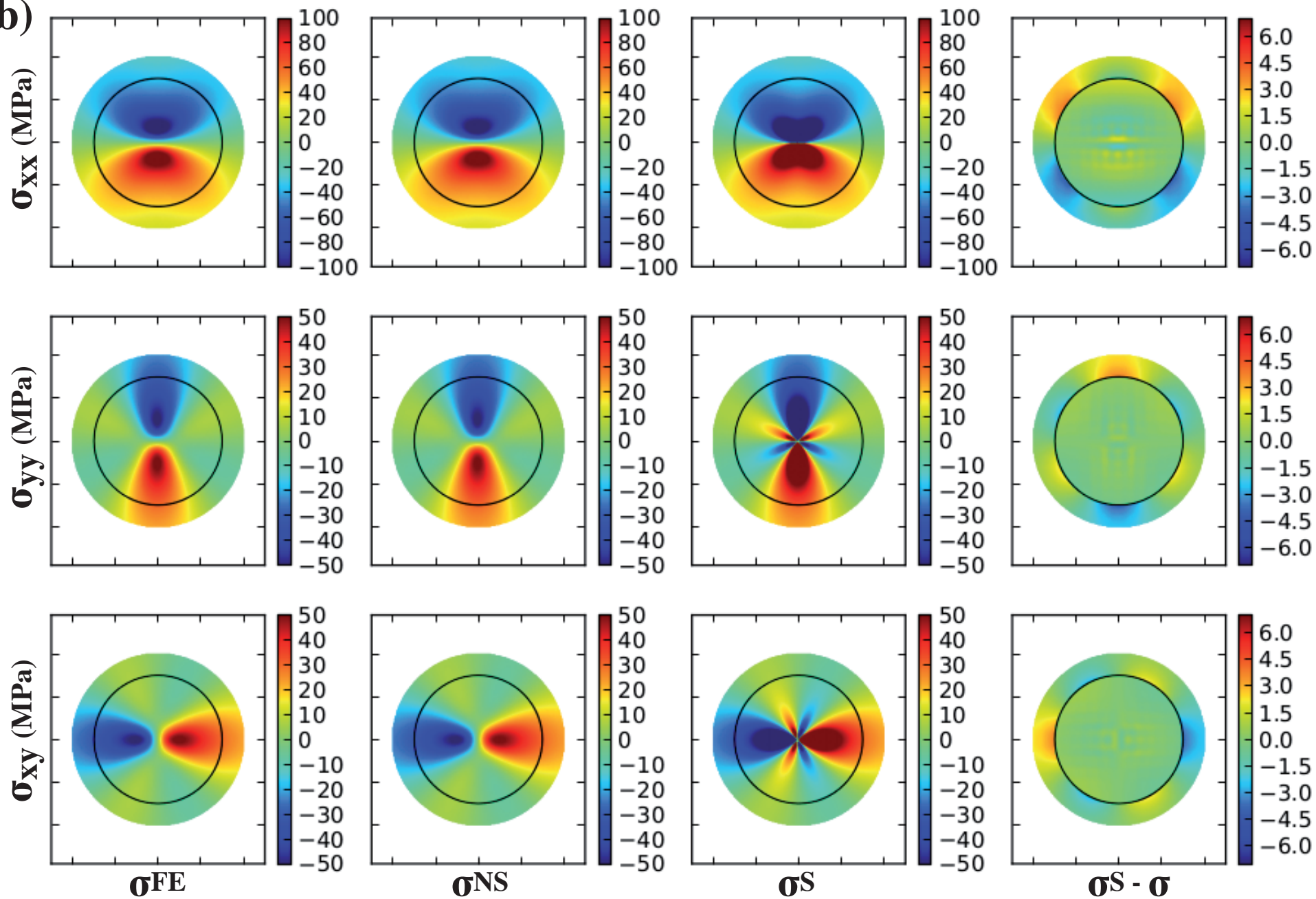
(a)**(b)**

Figure

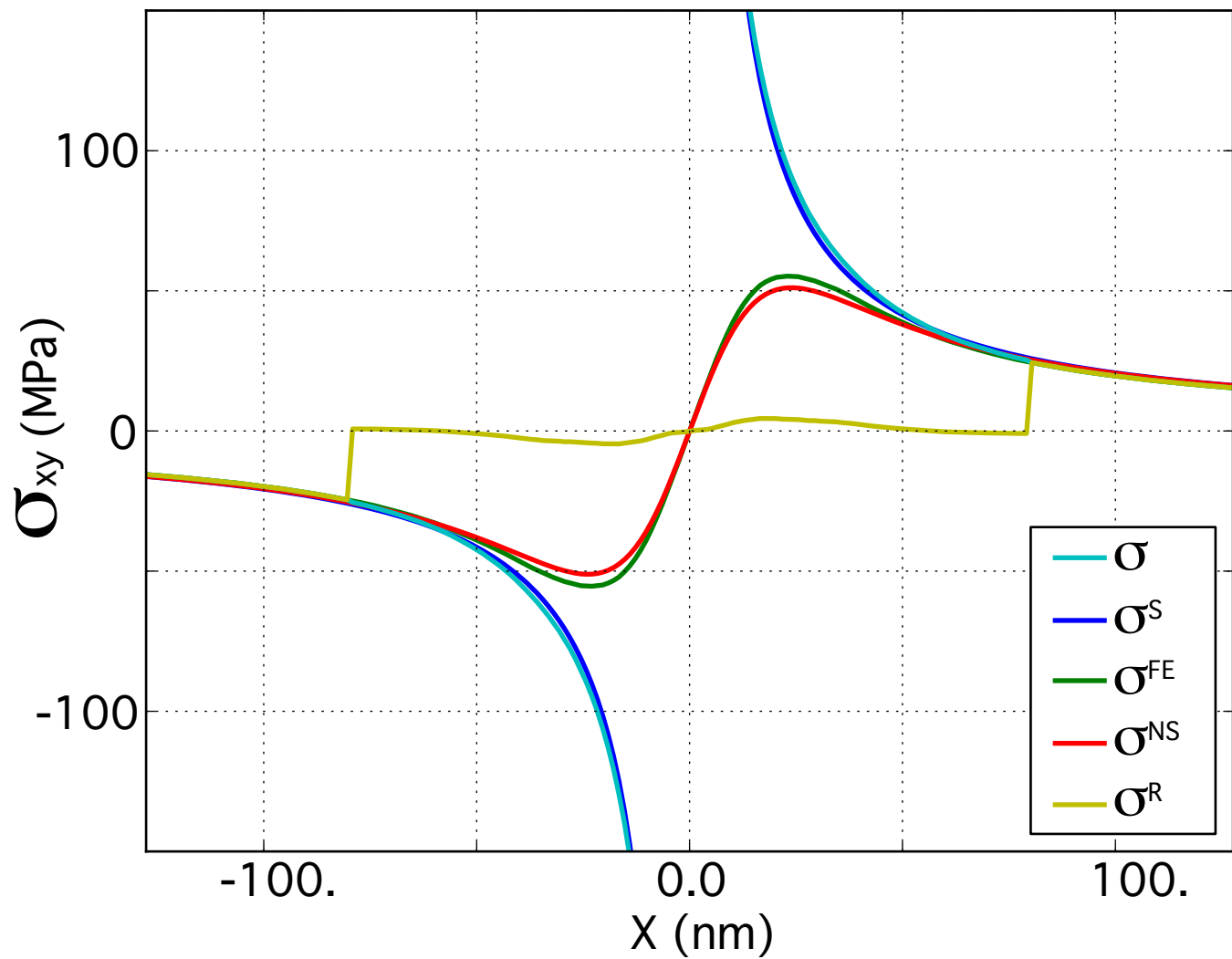

Figure

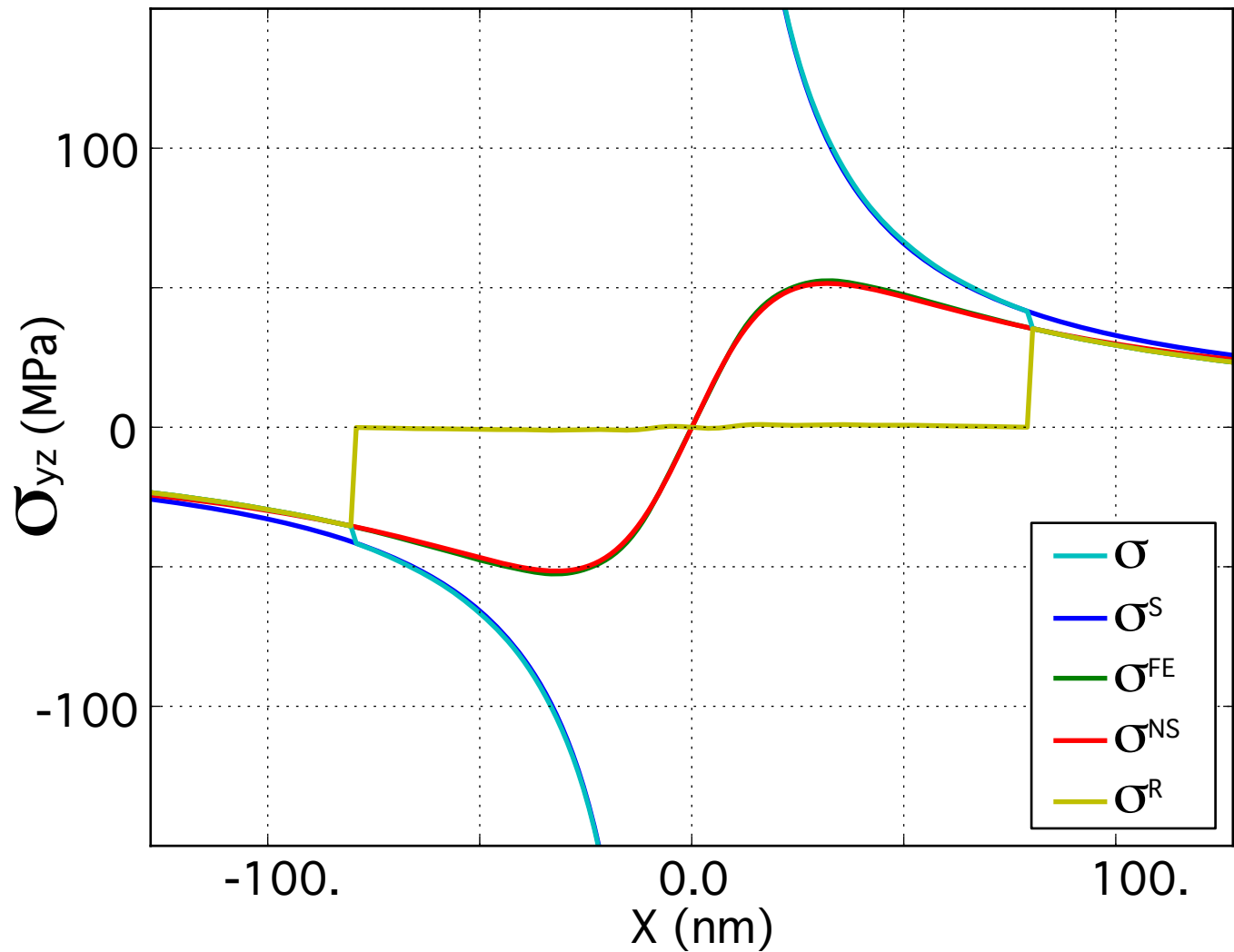

Figure

- ▽ DCM 12x12x12 cubic mesh
- DCM 20x20x20 cubic mesh
- ⬡ DCM 40x40x40 cubic mesh
- ◆ DD without periodic replicas
- DD 1 layer of replicas
- ◆ DD 2 layers of replicas

