



**HAL**  
open science

## **STARS. D5.1 State of the art of EGNSS system for the rail application**

Juliette Marais, Julie Beugin, Francesco Rispoli, Peter Gurnik,  
Andrei-Bogdan Toma

### ► To cite this version:

Juliette Marais, Julie Beugin, Francesco Rispoli, Peter Gurnik, Andrei-Bogdan Toma. STARS. D5.1 State of the art of EGNSS system for the rail application. [Research Report] IFSTTAR - Institut Français des Sciences et Technologies des Transports, de l'Aménagement et des Réseaux. 2017, 61p. hal-01636102

**HAL Id: hal-01636102**

**<https://hal.science/hal-01636102>**

Submitted on 16 Nov 2017

**HAL** is a multi-disciplinary open access archive for the deposit and dissemination of scientific research documents, whether they are published or not. The documents may come from teaching and research institutions in France or abroad, or from public or private research centers.

L'archive ouverte pluridisciplinaire **HAL**, est destinée au dépôt et à la diffusion de documents scientifiques de niveau recherche, publiés ou non, émanant des établissements d'enseignement et de recherche français ou étrangers, des laboratoires publics ou privés.



## D5.1 State of the art of EGNSS system for the rail application

**Project acronym:** STARS  
**Project full title:** Satellite Technology for Advanced Railway Signalling  
**EC Contract No.:** (H2020) 687414

**Version of the document:** 08  
**Protocol code:** STR-WP5-D-IFS-033  
**Responsible partner:** IFSTTAR  
**Reviewing status:** Final  
**Delivery date:** 06/01/17  
**Dissemination level:** PUBLIC

## CHANGE RECORDS

Version	Date	Changes	Authors
01	22.06.2016	First draft sent to WP5 partners	J. MARAIS (IFSTTAR), J. BEUGIN (IFSTTAR)
02	21.07.2016	Second draft after comments of Jean Poumailloux (TAS), Karel Veselý (AZD), Barbara Brunetti (ASTS)	J. Marais (IFSTTAR)
03	22.07.2016	Locoprol, Satloc, Girasole, Ecorail added in table IV	J. Marais (IFSTTAR)
04	26.07.2016	Added information about 3inSat	F. Rispoli (ASTS)
05	01.09.2016	5 <sup>th</sup> draft after comments of M. Rousseau (ALS) about Locoprol/Locoloc	J. Marais (IFSTTAR)
06	05.10.2016	Inclusion of NGTC and line about NGTC in table IV	J. Marais (IFSTTAR), P. Gurnik (UNIFE)
07	18.12.2016	Final version after ASTS comments	J. Marais (IFSTTAR)
08	06.01.2017	Final version after TMT approval	A. Toma (DAPP)

## TABLE OF CONTENTS

<b>CHANGE RECORDS</b> .....	<b>2</b>
<b>TABLE OF CONTENTS</b> .....	<b>3</b>
<b>LIST OF FIGURES</b> .....	<b>4</b>
<b>1 INTRODUCTION</b> .....	<b>5</b>
1.1 Executive summary.....	5
1.2 Definitions and acronyms.....	5
<b>2 GNSS AUGMENTATION SYSTEMS</b> .....	<b>9</b>
2.1 General principles.....	9
2.2 GBAS.....	11
2.3 SBAS.....	12
<b>3 EGNSS USE IN RAIL APPLICATIONS - PREVIOUS INITIATIVES AND RESULTS</b> .....	<b>17</b>
3.1 The application context in Europe.....	17
3.2 Main project objectives, performances and characteristics.....	19
3.3 Review of solutions.....	33
3.4 Synthesis.....	39
<b>4 DISCUSSION ON THE SUITABILITY OF INTEGRITY CONCEPTS IN RAIL ENVIRONMENTS</b> .....	<b>41</b>
4.1 Identified experiences.....	41
4.1.1 GBAS-based integrity concepts.....	41
4.1.2 SBAS-based integrity concepts.....	43
4.1.3 Combination of SBAS and GBAS.....	44
4.2 Identified or known EGNOS limitations [48].....	46
4.3 EGNOS limitations in the rail environment.....	48
4.3.1 EGNOS suitability to rail specifications.....	48
4.3.2 EGNOS availability.....	49
4.3.3 Classical pseudo-range error models versus real models.....	50
4.3.4 PL computation on the basis of LOS models.....	51
<b>5 CONCLUSIONS</b> .....	<b>55</b>
<b>6 ANNEX</b> .....	<b>56</b>
<b>7 REFERENCES</b> .....	<b>57</b>

## LIST OF FIGURES

Figure 1: Possible situations obtained with GNSS integrity monitoring .....	11
Figure 2: LAAS architecture (Source FAA.org) .....	12
Figure 3: EGNOS v2 architecture (Source [48]).....	14
Figure 4: Existing and planned SBAS (Source [58]) .....	15
Figure 5: ETCS Levels [4] .....	17
Figure 6: Estimated positioning accuracy with and without EGNOS along an Italian High speed railway line [45]. .....	33
Figure 7: NGTC preliminary functional architecture for ERTMS virtual balise concept.....	36
Figure 8: GaLoROI localization unit vehicle equipment [17].....	37
Figure 9: SIL2 architecture of the GRAIL2 project [31].....	37
Figure 10: High integrity architecture of GNSS/INS positioning with Fault Detection and Diagnosis based on Principal Component Analysis [35]. CKF is a cubature Kalman filter, variation of the Kalman filter. ....	38
Figure 11: Flowchart of AIMA-aided GNSS-based train integrated positioning [64] .....	38
Figure 12: Illustrations of the satellite state detection in a fisheye image on the original image and on classified regions [40]. .....	39
Figure 13: Overview of GNSS LDS System [43]. .....	45
Figure 14: Histogram of position estimation error. Left: Only EGNOS mode, Right: Only TALS Mode [43]. .....	45
Figure 15: EGNOS availability along train routes in Italy, measured in the Locoprol project [45]. ..	49
Figure 16: Distribution of the positioning mode measured along an Italian line in the RUNE project: no solution in blue, GNSS alone in green and GNSS/EGNOS in red [62]. .....	50
Figure 17: Pseudo-range error distribution versus time for LOS and NLOS received satellites [44]. .....	51
Figure 18: PL obtained in the RUNE project along a line considering that valid positions require that PDOP<6 [18]. .....	52
Figure 19: Roma-Pisa railway line. Protection level versus travelled distance with GPS constellation alone. PL is computed without augmentation system in blue (RAIM) and with the support of trackside augmentation systems for the other curves [10].....	53
Figure 20: Stanford diagram.....	54

# 1 INTRODUCTION

## 1.1 EXECUTIVE SUMMARY

The objective of STARS task 5.1 is to review the existing navigation augmentation systems and services in terms of performances achieved and application environments, and to analyse the experimentations and projects already performed in railway applications related to the use of these systems and services.

**This report aims to draw the state of the art of existing monitoring system (as used in aeronautics) and past experiences of railways when using such concepts. The focus only concerns GNSS-based positioning systems and do not pretend to present the global systems developed to insure the complete safety level of railway signalling.**

This report is composed of three main sections: after a short presentation of these augmentation systems, the second part aims to highlight the levels of performance achieved, the existing limitations and their applicability in the railway context and constraints. The last section will address the suitability of the concept of integrity monitoring (developed for aviation) in the railway environment. This first task of WP5 shall be a basis for discussions of solutions to be defined for railways.

As a state of the art, this deliverable relies on published articles, past projects deliverables, and information given by the STARS partners about the past projects through a questionnaire.

## 1.2 DEFINITIONS AND ACRONYMS

Acronym	Meaning
AIMA	Autonomous Integrity Monitoring and Assurance
AIMN	Augmentation and Integrity Monitoring Network
AL	Alert Limit
ANSF	Agenzia Nazionale per la Sicurezza delle Ferrovie
APOLO	Advanced Position Locator
ASQF	Application Specific Qualification Facility
ATLAS	Advanced Train LocAtion Simulator
ATMS	Automated Train Management System
ARAIM	Advanced Receiver Autonomous Integrity Monitoring
ARTC	Australian Rail Track Corporation
ATC	Automatic Train Control

ATP	Automatic Train Protection
CBTC	Communication-Based Train Control
CCS TSI	Technical Specification for Interoperability relating to the Control-Command and Signalling
CPF	Central Processing Facility
CPN	Coloured Petri Net
EATS	ETCS Advanced Testing and Smart Train Positioning System
ECAC	European Civil Aviation Conference
eFT	extended Fault Tree
EGNSS	European GNSS
EGNOS	European Geostationary Navigation Overlay Service
ERA	European Railway Agency
ERSAT (EAV)	ERTMS on SATELLITE (Enabling Application Validation)
ERTMS	European Rail Traffic Management System
ETCS	European Train Control System
EVC	European Vital Computer
EWAN	EGNOS Wide Area Network
FAA	US Federal Aviation Administration
FDD/FDE	Fault Detection and Diagnosis/Exclusion
GADEROS	Galileo Demonstrator for Railway Operation System
GALOROI	Galileo Localization for Railway Operation Innovation
GBAS	Ground-Based Augmentation System
GIRASOLE	Galileo Receiver for Safety of Life Equipment
GIVE	Grid Ionospheric Vertical Error
GLONASS	globalnaia navigatsionnaia spoutnikovaia sistema
GNSS	Global Navigation Satellite Systems

GPS	Global Positioning System
GRAIL	GNSS introduction in the RAIL Sector
GRAIL-2	GNSS-based enhanced odometry for Rail
GSM-R	GSM for railway
HDOP	Horizontal Dilution of Precision
ICAO	International Civil Aviation Organization
ISA	Independent Safety Assessor
IOR	Indian Ocean Region
KPI	Key Performance Indicator
LAAS	Local Area Augmentation System
LDS	Location Determination System
LOCOPROL	Low Cost satellite based train location system for signalling and train Protection for Low-density traffic railway line
LOS/NLOS	Line-of-Sight/Non-line-of-Sight
LRK	Long-Range Kinematic
MCC	Master Control Centre
MOPS	Minimum Operational Performance Standard
NGTC	Next Generation Train Control
NLES	Navigation Land Earth Stations
NSA	National Safety Authority
NoBo	Notified bodies
PA/NPA	Precision Approach/Non Precision Approach
PACF	Performance Assessment and Checkout Facility
PL/HPL	Protection Level/Horizontal PL
PVT	Position, Velocity and Time
RAIM	Receiver Autonomous Integrity Monitoring



RBC	Radio Block Centre
RAMS	Reliability, Availability, Maintainability and Safety
RHINOS	Railway High Integrity Navigation Overlay System
RIMS	Ranging Integrity Monitoring Stations
RIM RS	Ranging & Integrity Monitoring Reference Stations
RNP	Required Navigation Performances
RUNE	Railway User Navigation Equipment
SaPPART	Satellite Positioning Performance Assessment for Road Transport
SBAS	Satellite-Based Augmentation System
SIL	Safety Integrity Level
SIS	Signal In Space
STARS	Satellite Technology for Advanced Railway Signalling
SREW	Satellite Residual Error for the Worst User Location
TDOA	Time Difference of Arrival
THR	Tolerable Hazard Rates
TTA	Time To Alert
TOA	Time of Arrival
UERE	User Equivalent Range Error
UDRE	User Differential Range Error
UNISIG	Union industry of signalling
VHF	very high frequency
WAAS	Wide Area Augmentation System
WCT	Wireless Communications Technology
QZSS	Quasi Zenith Satellite Solution
3inSat	Train Integrated Safety Satellite System

## 2 GNSS AUGMENTATION SYSTEMS

This section aims to present the basics of GNSS augmentation systems as a background for a good understanding of the following results and issues.

### 2.1 GENERAL PRINCIPLES

Development of GNSS augmentation systems characteristics has been driven by the requirements of civil aviation safety procedures. Indeed, the augmentation systems are intended primarily to support precision approach operations before the landing phase. For such operations, the user requires to be warned in real-time in case the positioning error exceeds the requirements or in case of a failure.

Thus, the main idea of GNSS augmentation system is to compensate part of the positioning errors, often called “common mode errors”, as it is experienced by a GNSS user on the ground (typically a GNSS receiver) similarly to a GNSS antenna/receiver belonging to an augmentation system.

GBAS assumes that two receivers situated in close vicinity will face some close errors caused by ionospheric propagation, satellite position or clock errors, etc. SBAS system relies in a separation of the different error causes (clock, ephemeris & ionosphere). For SBAS, these error contributions and the associated UDRE&GIVE are recombined by user receiver according to the user geographical position hence obtain the capability to offer differential corrections on a wide area.

The first function of GNSS augmentation systems, whatever they are, is to transmit the pseudo-range correction to the user for him/her to benefit of a better accuracy. A second service is integrity monitoring.

The transmission can be performed by terrestrial or satellite links and will offer respectively local or wide area services. This will be the main difference between GBAS and SBAS presented above. Moreover, the media used for broadcast will condition the targeted area.

#### ACCURACY ENHANCEMENT

Accuracy is the degree of conformance of the estimated position with the true position. Accuracy is a statistical measure of performance and indicates trueness and precision in terms of confidence level with respect to a confidence interval.

As every augmentation system, the system relies on a network of monitoring stations (with very well-known positions). Each station receives GNSS signals that are processed in order to estimate the pseudo-range corrections by comparison with the known monitoring station position.

Once the pseudo-range corrections have been computed, they are transmitted in the form of “differential corrections” by means of either a terrestrial radio link either a GEO satellite.

#### INTEGRITY MONITORING

The second function of an augmentation system is to offer guarantees to the user about the position confidence level. The system shall detect system and propagation failures (as a satellite

failure or message error, or ionospheric failure) and alert the user in a dedicated time (TTA – Time To Alert).

Integrity is a measure of trust that can be placed in the correctness of the information supplied by a navigation system and it includes the ability of the system to provide timely warnings to users when a satellite or the entire system should not be used for navigation. This definition can be clarified thanks to four main parameters: Alert Limit (AL), Integrity Risk, Time to Alert (TTA) and Protection Level (PL).

- Alert Limit represents the largest position error allowable for safe operation.
- Integrity Risk is the probability of providing a signal leading to a position that is out of tolerance without warning the user in a given period of time. It defines the maximum probability with which a fault free receiver is allowed to provide position failures not detected by the integrity monitoring system.
- Time to Alert (TTA) is the maximum allowable elapsed time from the onset of a positioning failure until the equipment announces the alert.
- The PL is a statistical error bound computed so as to guarantee that the probability of the absolute position error exceeding the alert limit is smaller than or equal to the target integrity risk.

For terrestrial transport, the HPL (Horizontal PL) is of main interest and bounds the horizontal position error with a confidence level derived from the integrity risk requirement. As the true HPE (Horizontal Position Error) is never known, except in test or evaluation conditions with reference measurements, HPL is the indicator of accuracy and is compared to HAL, defined by the application requirements. As summarized in figure 1, the system is declared available when  $HPL < HAL$  and unavailable when  $HPL > HAL$ . If correctly estimated, HPE should always be smaller than HPL as presented in the two first cases of figure 1. Then, we can consider that the integrity monitoring process correctly protect the system from being unsafe. First case is the nominal case where the integrity monitoring process correctly works and the position information can be used with confidence. In the second case, the system is declared unavailable, i.e. it cannot guarantee the safety of the position. The train shall be located by another system or stopped (for safety procedure). The third and fourth cases represent situations where HPE is not correctly bounded by HPL. In the third case, as the true error remains below the requirements ( $HPE < HAL$ ), it is not critical for safety (false detection). Some operational constraints can occur but the system remains safe. However, due to non-detected failures HPE can sometimes exceed HAL as illustrated in the fourth case. Staying below the requirements ( $HPL < HAL$ ) the alert will not be activated.. But in case HPE exceeds HAL, a risk on integrity occurs. The occurrence of this last event has to be strongly minimized.

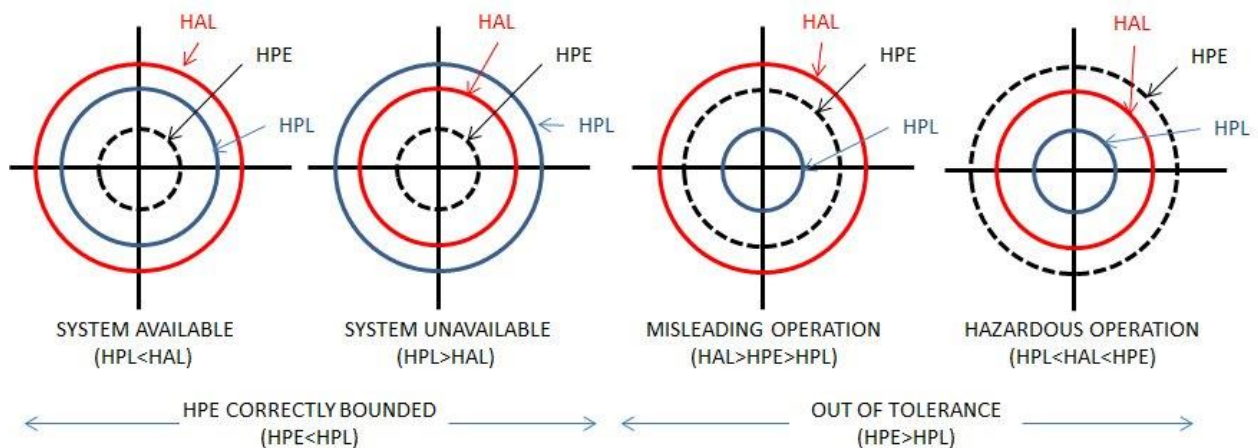

Figure 1: Possible situations obtained with GNSS integrity monitoring

## 2.2 GBAS

Ground-Based Augmentation System (GBAS) is a local GNSS augmentation system based on terrestrial radio links that provides differential corrections and integrity monitoring of Global Navigation Satellite Systems (GNSS). Main application of GBAS is to provide navigation and precision approach service in the vicinity of the host airport (approximately a 23 nautical mile radius or 42.6km) in order to yield the extremely high accuracy, availability, and integrity necessary for some of the approaches defined in aviation.

In the past, the FAA referred to GBAS as the Local Area Augmentation System (LAAS). Its architecture is presented in figure 2. The system relies of a ground infrastructure composed of a network of monitoring stations that collect GNSS pseudo ranges measurements. The precise positions of the monitoring stations being known, the comparison between measurements and expected observations make the system capable of sending differential corrections to the users approaching the monitored area. Messages are broadcasted via a very high frequency (VHF) radio data link from a ground-based transmitter.

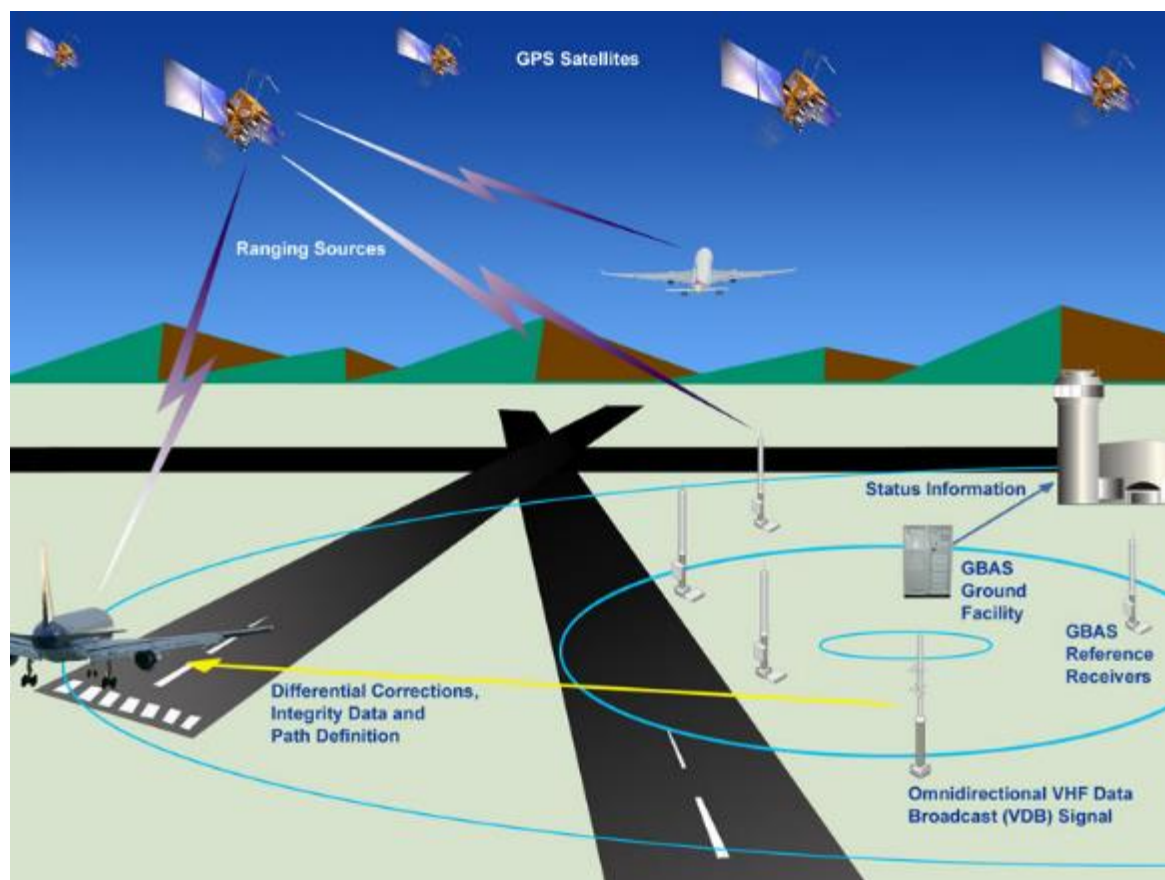

Figure 2: LAAS architecture (Source FAA.org)

GBAS demonstrated accuracy is less than one meter in both the horizontal and vertical axis (1 sigma confidence level (Source faa.gov)).

### 2.3 SBAS

SBAS Satellite-Based Augmentation System, originally implemented by the U.S.A FAA as Wide Area Augmentation System (WAAS) (as opposed to LAAS-Local Area Augmentation Systems). In SBAS, additional signals and correction messages are broadcast from geostationary (GEO) satellites.

Presently, in Europe, EGNOS (Version 2) is the SBAS solution developed and currently augments L1 (1575.42 MHz) Coarse/Acquisition (C/A) civilian signal function [58]. Version three will feature new capabilities, including dual frequency and dual-constellation with both GPS and Galileo, EGNOS is composed of two main segments: the ground segment (composed of both the control and user segments) and the space segment.

#### THE GROUND SEGMENT

The ground segment is a network of Ranging Integrity Monitoring Stations (RIMS) and Earth Stations (NLES) linked with the EGNOS Wide Area Network (EWAN), as the MCC (Master Control Centres). Two additional facilities (the Performance Assessment and Checkout Facility (PACF) and

the Application Specific Qualification Facility (ASQF)) are also deployed to support system operations and service provision.

The RIMS are located all over Europe and abroad and collect continuously GPS measurements. Raw data are sent to the Central Processing Facility (CPF) of each Mission Control Centre (MCC) that will estimate the corrections to improve the accuracy of the users inside the service area (called ECAC). The corrections include clock errors, orbital positions and ionospheric delays.

Moreover, the CPF estimates the residual errors, i.e. an over bound of residual errors expected after having applied corrections broadcasted by EGNOS. The errors are characterised by two parameters:

- User Differential Range Error (UDRE).  
The UDRE estimates the residual range error after the application of SV clock and ephemeris error correction for a given GNSS satellite.
- Grid Ionospheric Vertical Error (GIVE).  
GIVE estimates the vertical residual error at predefined Ionospheric Grid points after application of the ionospheric corrections for a given geographical grid point.

These parameters will be of main importance to bound the user positioning error in the safety-critical applications.

Table I presents positioning error in a conservative approach, i.e. for a “worst user location” and is then considered as worse than the classical experience measurements. The Satellite Residual Error for the Worst User Location (SREW) represents the residual range error due to the SV ephemeris and clock errors once EGNOS corrections are applied.

Table I. Typical EGNOS and GPS stand-alone SIS UERE [58]

Error sources ( $1\sigma$ )	GPS - Error Size (m)	EGNOS - Error Size (m)
GPS SREW	4.0 (see note 1)	2.3
Ionosphere (UIVD error)	2.0 to 5.0 (see note 2)	0.5
<i>Troposphere (vertical)</i>	0.1	0.1
<i>GPS Receiver noise</i>	0.5	0.5
<i>GPS Multipath (45° elevation)</i>	0.2	0.2
GPS UERE 5° elevation	7.4 to 15.6	4.2 (after EGNOS corrections)
GPS UERE 90° elevation	4.5 to 6.4	2.4 (after EGNOS corrections)

*Note 1: As of GPS Standard Positioning Service Performance Standard [GPS SPS 2008].*

*Note 2: This is the typical range of ionospheric residual errors after application of the baseline Klobuchar model broadcast by GPS for mid-latitude regions*

The CPF also monitors and detect GNSS anomalies if necessary and is required to specify the user of any dysfunction within a time  $t < TTA$  (Time To Alert).

Messages are then transmitted to the NLEs in charge of up linking it to the GEO satellites;

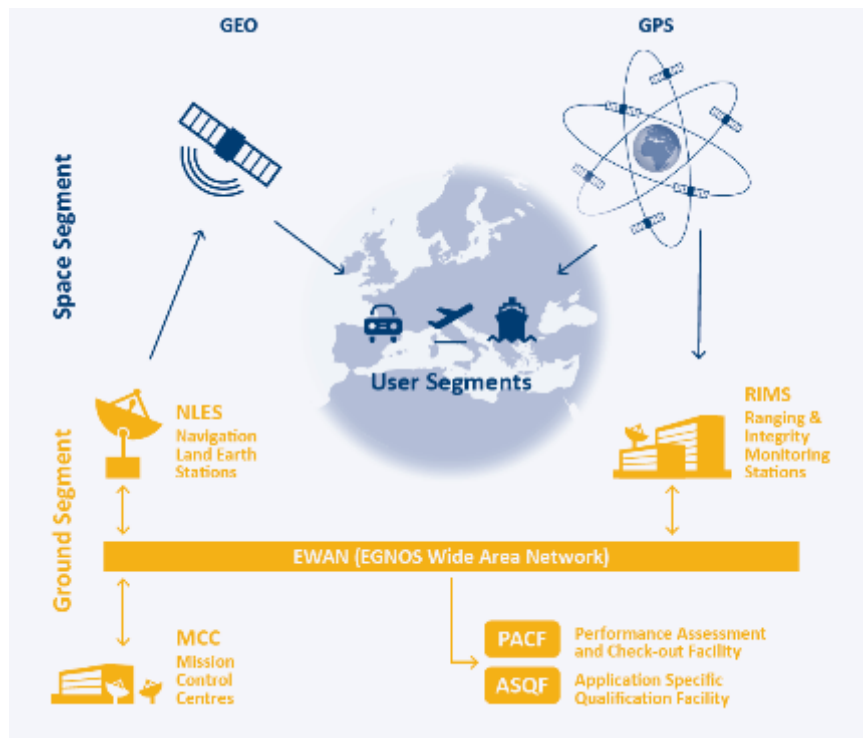

Figure 3: EGNOS v2 architecture (Source [48])

### THE SPACE SEGMENT

The map of figure 4 represents existing and planned SBAS solutions covering the different areas in the world. WAAS, EGNOS and MSAS are today in operation, while SDCM and GAGAN are investigated.

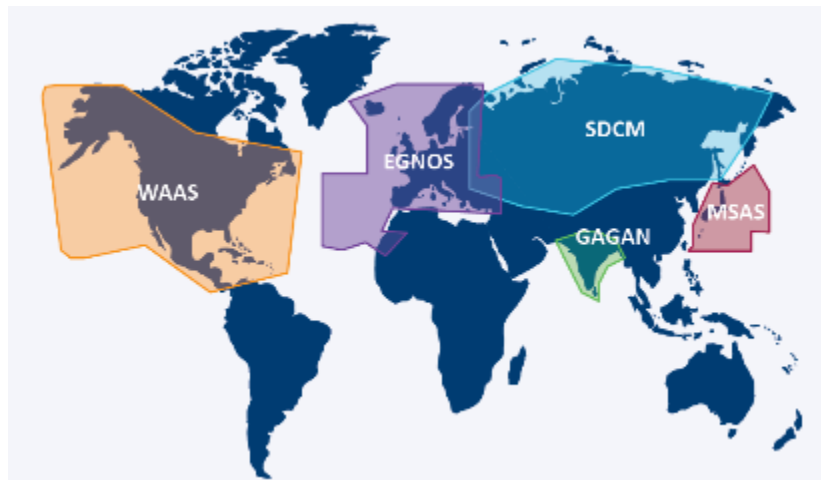

Figure 4: Existing and planned SBAS (Source [58])

At the date of the deliverable, the EGNOS GEO satellites that are transmitting the operational Signal-In-Space (SIS) to be used by EGNOS users are [58]:

- INMARSAT 3F2 AOR-E (PRN 120) and SES-5 (PRN 136) are part of the EGNOS operational platform
- ASTRA-5B (PRN 123) and INMARSAT 4F2 EMEA (PRN 126) are part of the EGNOS TEST Platform.

Every satellite of an SBAS provides both differential corrections on the wide area and the parameters required to guarantee the integrity of the GNSS user.

EXPECTED ACCURACY PERFORMANCES

With access to the Open Service, EGNOS allows the user to position with a better accuracy than GPS alone, although with a worse accuracy if compared to GBAS performance 1m accuracy with 1-sigma confidence level in both horizontal and vertical axis as mentioned in section 2.2. Horizontal position is expected below 3m as specified in table II.

Table II. OS Horizontal and Vertical Accuracy [58]

	Definition	Value
Horizontal	Corresponds to a 95% confidence bound of the 2-dimensional position error <sup>15</sup> in the horizontal local plane for the Worst User Location <sup>16</sup>	3m
Vertical	Corresponds to a 95% confidence bound of the 1-dimensional unsigned position error in the local vertical axis for the Worst User Location	4m

EXPECTED INTEGRITY PERFORMANCES

For the integrity in the range domain, the range error is partially bounded by a threshold based on the UDRE and GIVE parameters. For each pseudo range, it is supposed that the total range error



shall be less than 5.33 times the estimated standard deviation ( $\epsilon \leq 5.33\sigma$  where  $\epsilon$  is total true Range error and  $\sigma$  is the computed SBAS Range error estimate standard deviation). This assumption may almost always be true for aviation but NOT in railway applications where the local environment is much more challenging.

UDRE and GIVE bound properly the true range error in the measurements if  $5.33xUDRE > SREW$  and  $5.33xGIVE > GIVD$  with the adequate level of probability determined by the integrity risk. The EGNOS SoL safety level of probability is 99.99999%. In aviation applications, the observed maximum values for SREW/UDRE and GIVD / GIVE are both around 3 (Extracted from [58]).

### 3 EGNSS USE IN RAIL APPLICATIONS - PREVIOUS INITIATIVES AND RESULTS

EGNSS is in the heart of European projects since the beginning of the 2000s, in the context of the ERTMS deployment also. The aim of this chapter is to summarize previous initiatives and results with a focus on their use of the EGNOS signals and data when studied. This chapter is composed of the following sections: first, the presentation of the European context of ERTMS which is the application context of most of the projects. The second section summarize the project objectives, the GNSS performances, specified and reached, and the use (or not) of integrity monitoring solutions. The last section presents a review of solutions.

#### 3.1 THE APPLICATION CONTEXT IN EUROPE

Historically, in Europe, each country developed its own railway infrastructure, equipment and operational rules. The consequences are heterogeneity of electrification, rolling stock, maintenance and exploitation rules, signalling... Europe has defined the ERTMS (European Rail Traffic Management System) to harmonize this. ETCS is the ERTMS sub-system dedicated to control and to protect trains. Migration is progressive and performed by stages from level 0 to 3. The goal is first to let coexist current external systems and new balises and to progressively move some of the trackside equipment to transpose intelligence on-board.

In the levels 1 and 2 of ETCS, the train position knowledge is based on an odometer and a beacon reader, interfaced with the EVC (European Vital Computer) train-borne sub-system (cf. figure 5). Such sensors are well-known and controlled by the railway community, which has a certain confidence in them. However, the global ETCS infrastructure is costly and this cost slows down its deployment. It is then necessary for future systems to think about alternative solutions [3].

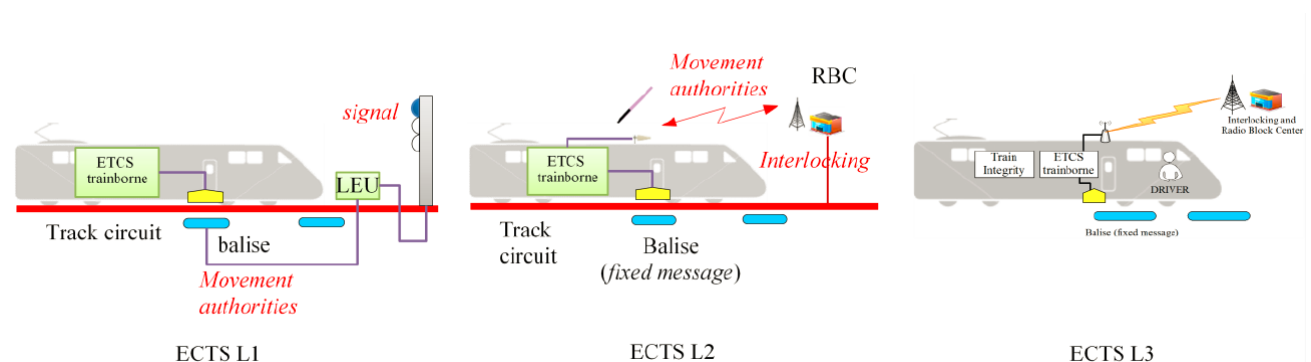

Figure 5: ETCS Levels [4]

GNSS is envisaged in the highest level of ETCS or its declination to regional lines, namely ETCS L3 and ETCS Regional. In level 3, no line side signals will be required for delivering movement authorities. A train shall be able to locate itself [4]. All information will be exchanged between the ETCS on-board system and the RBC trackside system (Radio Block Centre) through mobile network. Trains will communicate their location and integrity (safety information guaranteeing that the train did not lose any wagon and that train true position is not outside train position confidence interval with a certain probability determined by the confidence level i.e. SIL4). This level shall also

improve line capacity by making possible to manage circulations with moving blocks. In this context, GNSS is investigated to be the basis for the embedded train locator.

The use of GNSS in order to provide a low cost solution for signalling and in particular in the highest levels of ETCS (level 3) and the ERTMS Regional has been an issue since the beginning of the 2000's [9]. With several projects, the European Commission, through the successive Framework Programs funded researches in order to explore and promote the use of satellites for such solutions. First main projects were APOLO [12], GADEROS [7] and LOCOPROL [8] but one can mention tens of others in the past decade until the recent GaLoROI [6] or 3inSat [5] projects. All these projects, if they did not lead to operational commercialized products, surely helped GNSS to be introduced in railway mentalities.

Table III recall the main projects aiming at introducing GNSS in rail (list non exhaustive however).

<b>Project name</b>	<b>Start</b>	<b>End</b>	<b>Funding program</b>
APOLO	1998	2001	
GADEROS	2001	2004	5 <sup>th</sup> FP
INTEGRAIL	2001	2004	
LOCOPROL/LOCOLOC	2001	2004	5 <sup>th</sup> FP/ESA
ECORAIL	2001	2005	ESA
RUNE	2001	2006	
GIRASOLE	2005	2007	6 <sup>th</sup> FP/GJU
GRAIL	2005	2007	6 <sup>th</sup> FP/GJU
GRAIL 2	2010	2013	7 <sup>th</sup> FP
GALOROI	2012	2014	7 <sup>th</sup> FP
SATLOC	2012	2014	7 <sup>th</sup> FP
3inSat		2016	ESA, ARTES 20 IAP
RHINOS	2016	2018	H2020
ERSAT EAV	2015	2017	H2020

Most of these projects included the intention to use EGNOS.

### **3.2 MAIN PROJECT OBJECTIVES, PERFORMANCES AND CHARACTERISTICS**

In this section, we aim to present the main objectives and characteristics of the previous mentioned projects, their use of GNSS and, if used, how EGNSS contributes to the railway applications. Table IV make the synthesis of these different aspects based on answers brought by the different STARS partners involved in these projects.

## SATELLITE TECHNOLOGY FOR ADVANCED RAILWAY SIGNALLING

Table IV Synthesis about previous GNSS projects

Legend: **EGNSS highlighted in red**

System architecture	Objective	Positioning-related Performances, specified and obtained	Model / characterization of the environment of reception and scenarios / tests considered in this environment	Integrity monitoring implementations and general safety aspects
<b>APOLO</b> GPS receiver in various operating modes (standalone, <b>DGPS</b> , <b>EGNOS</b> ) + Odometer + Gyroscope + Accelerometer + Doppler Radar	1 <sup>st</sup> test of the ability of the GPS to be used in railway application	<ul style="list-style-type: none"> <li>- <b>No performances specified</b></li> <li>- <b>Accuracy</b> obtained: <ul style="list-style-type: none"> <li>▫ Accuracy in GPS C/A mode was in the range of 3-4 m (2 drms, 95% of time)</li> <li>▫ Accuracy of DGPS was better than 1 m (2 drms, 95% of time)</li> <li>▫ Accuracy with EGNOS corrections is in the range of 1.0-1.5 m (2 drms, 95% of time)</li> </ul> </li> </ul>	<ul style="list-style-type: none"> <li>- <b>Operational scenarios:</b> multipath was eliminated by means of appropriate selection of test tracks (e.g. the choice of the smallest possible shadowing), using RTK mode and with fusion of sensor data</li> <li>- <b>Tests:</b> <ul style="list-style-type: none"> <li>▫ tests of potential influence of electromagnetic interference</li> <li>▫ The accuracy of the train locator was evaluated according to the selected operating mode and using a reference trajectory generated by means of RTK (144 tests drives).</li> </ul> </li> </ul>	<ul style="list-style-type: none"> <li>- <b>Integrity monitoring</b> was ensured using first EGNOS signals</li> <li>- No safety analysis</li> </ul>
<b>GADEROS</b> GPS + <b>EGNOS</b> + digital track map (some configuration with virtual balise database, some configuration hybridizing GNSS and an odometer and a gyrometer)	Tests of prototypes for conventional and low density railway lines equipped with ERTMS/ETCS	<ul style="list-style-type: none"> <li>- <b>Accuracy</b> requirements: <ul style="list-style-type: none"> <li>▫ for GNSS : 1 m for singular points (crossings, stations), 25 m between stations (areas of plain line)</li> <li>▫ Position accuracy along track: <math>\pm 2.6</math> m for virtual balise tracking purposes</li> <li>▫ Position accuracy across track: 1m (if used for parallel track identification)</li> <li>▫ Speed accuracy: <math>\pm 2</math> Km/h for speed lower than 30 Km/h, then increasing linearly up to <math>\pm 12</math> Km/h at 500 Km/h</li> </ul> </li> <li>- <b>Availability</b> requirements: <ul style="list-style-type: none"> <li>▫ 99.8% (% of mission time) for GNSS</li> <li>▫ 99.99999% within the period needed to capture a virtual balise group and &gt;99,98 % of mission time in the rest of the line</li> </ul> </li> <li>- <b>Continuity</b> requirements: 99.99999% within the period needed to capture a virtual balise group and &gt;99,98 % of mission time in the rest of the line</li> </ul>	<ul style="list-style-type: none"> <li>- <b>Operational scenarios:</b> Four scenarios were described and tested: <ul style="list-style-type: none"> <li>▫ S1: GPS only</li> <li>▫ S2: GPS + hybridization</li> <li>▫ S3: GPS off + hybridization</li> <li>▫ S4: GPS degraded + hybridization</li> </ul> </li> <li>- <b>Tests:</b> <ul style="list-style-type: none"> <li>▫ Laboratory test (for demonstration of the VB interoperability concept)</li> <li>▫ Integration on board test (integration of locator prototype)</li> <li>▫ Field tests (evaluation of GNSS performances, VB simulation) performed on commercial track in Spain in a 30-40 Km stretch within a commercial timetable</li> <li>▫ The reference track data was generated through averaging the</li> </ul> </li> </ul>	<ul style="list-style-type: none"> <li>- <b>Safety Analysis</b> was carried out from the point of view of the user, identifying a Tolerable Hazard Rate (THR) for the function to be performed by the GNSS Location Subsystem. From the point of view of the provider, a SIL was allocated to the different sub-functions and components, analysing causes of failure for each of them and proposing mitigation strategies.</li> </ul>

System architecture	Objective	Positioning-related Performances, specified and obtained	Model / characterization of the environment of reception and scenarios / tests considered in this environment	Integrity monitoring implementations and general safety aspects
		<ul style="list-style-type: none"> <li>- <b>Integrity</b> requirements:               <ul style="list-style-type: none"> <li>⌘ Alert limit: 2.5 x accuracy</li> <li>⌘ Time-to-Alarm: 1sec. (maximum 6 sec.)</li> <li>⌘ Alarm limit: 10 <math>\sigma</math> (at 95% confidence)</li> </ul> </li> <li>- <b>Accuracy error</b> obtained:               <ul style="list-style-type: none"> <li>⌘ GPS only (X error: 2.23m, Y error: 2.68m)</li> <li>⌘ GPS + EGNOS: errors at 4.11m</li> <li>⌘ GPS + hybridisation solutions (odometer + gyrometer) with and without noise of the train odometer. With noise: location accuracy errors are increased due to speed errors (20-30m), without noise: errors are at 3-4m</li> </ul> </li> <li>- Some <b>unavailability</b> of GPS L1 observed (availability: 96%) , rapid recovery of GNSS fix after bridge (only 2 or 3 seconds)</li> <li>- Unavailability observed of EGNOS</li> <li>- <b>Velocity</b> requirements:               <ul style="list-style-type: none"> <li>⌘ <i>unknown</i></li> </ul> </li> </ul>	<p>coordinate values of several LRK precision surveys of the test line</p> <ul style="list-style-type: none"> <li>⌘ The <b>EGNOS</b> IOR satellite was sometimes tracked, but there was very modest visibility. The Ionospheric corrections seemed more difficult to track consistently. Only for the 3 GPS satellites being surveyed from West Europe, corrections were computed but they were not sufficient for a complete evaluation of benefits of EGNOS.</li> </ul>	
<p><b>INTEGRAL</b>  <b>GPS receiver + EGNOS + Odometer + Angular rate sensor + Accelerometer + map</b></p>	<p>Use of EGNOS signals with other sensor data for safety-related application in diverse operational condition</p>	<ul style="list-style-type: none"> <li>- <b>Accuracy</b> requirements:               <ul style="list-style-type: none"> <li>⌘ discrimination between parallel tracks and track change at switches</li> <li>⌘ compatible to ETCS specifications (accuracy along-track &lt; 5 m + 5% of distance travelled, accuracy cross-track &lt; 1 m)</li> </ul> </li> <li>- <b>Integrity</b> requirements:               <ul style="list-style-type: none"> <li>⌘ alarm limit &lt; 20 m (terminals), &lt; 50 m (busy lines), &lt; 125 m (rural lines)</li> <li>⌘ time-to-alert &lt; 6 sec (target &lt; 1 sec in critical areas), integrity risk &lt; <math>3 \times 10^{-3}</math></li> </ul> </li> <li>- <b>Availability and continuity</b> requirements: system availability / continuity &gt; 99,99999% (i.e. unavailability &lt; <math>10^{-7}</math>) for every 20 sec. or 2 km travelled</li> <li>- <b>Accuracy</b> obtained mostly less than 3m if no multi-</li> </ul>	<ul style="list-style-type: none"> <li>- <b>characterization of the environment:</b> reception was analysed in post processing</li> <li>- <b>Tests:</b> <ul style="list-style-type: none"> <li>⌘ <b>Lab test</b> with a GNSS simulator</li> <li>⌘ <b>Field test</b> using DGPS to provide a position reference (some field tests had available highly accurate track maps). They have been run with 4 units from March to December 2003 on dedicated tracks in Austria (LogServ, Linz) and in Belgium (SNCB). For generating the position residuals, the integrated solutions were compared to the GNSS-only solutions which were corrected by</li> </ul> </li> </ul>	<ul style="list-style-type: none"> <li>- <b>Safety aspects:</b> <ul style="list-style-type: none"> <li>⌘ system qualification according to CENELEC standards ('electronic systems on rolling stock'): thermal, EMC, vibration</li> <li>⌘ The single data are fused by an integrated and fault tolerant ("hybrid") software</li> </ul> </li> </ul>

System architecture	Objective	Positioning-related Performances, specified and obtained	Model / characterization of the environment of reception and scenarios / tests considered in this environment	Integrity monitoring implementations and general safety aspects
		<p>path and serious shadowing. According to the results of the INTEGRAIL prototype system test campaigns, the accuracy of GNSS positioning with EGNOS will be satisfactory for train control applications at low traffic density lines :</p> <ul style="list-style-type: none"> <li>▫ <b>Static tests</b> proved that the quality of the ionospheric data provided through EGNOS is comparable to direct measurements but the scattering was slightly higher. The overall static performance gave residual horizontal position accuracies in the 2-3 m range (3 to 5 m in height)</li> <li>▫ <b>Dynamic test</b> residuals were in all cases below 1 m in horizontal position and 0.5 m/s in velocity. In height, residuals were below 2 m (position) and 0.5 m/s (velocity)</li> </ul>	<p>the recorded reference station data. Each INTEGRAIL mobile unit was shown to be able to provide reliable, high-rate, integrity-checked train position, velocity, time (PVT) and heading data on a continuous basis.</p> <ul style="list-style-type: none"> <li>▫ <b>Static tests</b> with different set-ups for the GNSS receiver (with/without EGNOS, various masking, shadowing)</li> <li>▫ <b>Dynamic test</b> residuals measured.</li> </ul>	<ul style="list-style-type: none"> <li>▫ GNSS SIS malfunctions were detected by cross-check of sensors and by assessment against the digital root data base</li> <li>- No safety analysis</li> </ul>
<p><b>LOCOPROL/LOCO LOC</b>  <b>GPS receiver + EGNOS + Beacon + Odometer</b></p>	<p>Development of a safe and complete GNSS-based navigation solution for low density railway lines and extension to ERTMS/ETCS</p>	<p>-No <b>accuracy</b> requirements</p> <p>-<b>Safety</b> requirements:</p> <ul style="list-style-type: none"> <li>▫ Safety target for the overall system is <math>10^{-9}</math>/h but for the positioning sub system <math>6 \cdot 10^{-11}</math>/h to comply with a SIL4. (achievable according to the preliminary safety case)</li> </ul> <p>The solution computed intervals, with accuracy most of the time around +/- 150m at 10-11/h with GPS only ( +/- 75m with 2 independent constellations)</p>	<p>3 test lines with similar results:</p> <ul style="list-style-type: none"> <li>▫ Gembloux (Belgium): rural and wooded</li> <li>▫ Nice-Digne (France): Mountainous &amp; tunnels</li> </ul> <p>PREDISSAT tool developed to predict satellite availability based on image processing knowledge of the environment.</p>	<p>No classical integrity monitoring. Use of redundant pairs of satellites to compute merged confidence intervals in order to ensure a high level of safety. Safety preliminary assessment performed in the frame of the project.</p>
<p><b>ECORAIL</b>  <b>GPS receiver + EGNOS + Odometer + Map</b></p>	<p>Use of GNSS for railway level crossing</p>	<p>-Requirements based on the recommendation of the GNSS user forum 2000</p> <p><b>Results:</b></p> <ul style="list-style-type: none"> <li>▫ Accuracy of the position &lt;3m</li> <li>▫ Additional radio delay 16m at 60km/h</li> <li>▫ Minimum confidence interval at max speed</li> </ul>	<p>Test along a line in Upper Austria operated by Stern &amp; Hafferl with a good GNSS visibility</p>	<p>Out of scope</p>

System architecture	Objective	Positioning-related Performances, specified and obtained	Model / characterization of the environment of reception and scenarios / tests considered in this environment	Integrity monitoring implementations and general safety aspects
		(60km/h) <20m ☐ Maximum confidence interval with a: - 10m-long EGNOS loss <18m - 100m-long EGNOS loss <21m - 1000m-long EGNOS loss <48m		
<b>RUNE</b> <b>GPS receiver + EGNOS + Odometer + IMU</b>	Use of GNSS as a virtual balise	<ul style="list-style-type: none"> <li>- <b>Accuracy</b> requirements:               <ul style="list-style-type: none"> <li>☐ position: 5m + 5% of travelled distance</li> <li>☐ position objective: 3m, 95%</li> <li>☐ velocity: 2 km/h for v &lt; 30km/h, 12km/h for v &lt; 500 km/h</li> <li>☐ velocity objective: 2 km/h 95%</li> </ul> </li> <li>- <b>Integrity</b> requirements:               <ul style="list-style-type: none"> <li>☐ position confidence objective: &gt; 99.9% for a 50m protected distance</li> </ul> </li> <li>- <b>Availability</b> requirements: &gt; 99%</li> </ul> <p><b>Obtained Performance HW in the loop Lab tests:</b></p> <p><b>CRUISE &amp; ACCELERATION</b> scenarios:  <u>Conditions:</u>            ☐ 10 m/s - 70 m/s constant velocity, 36 min run            ☐ Accel. 0.01 - 0.06 g leading to Cruise of 36 to 252 Km/h  <u>Results:</u>            Velocity err = 0.02 m/s 1sigma            Position err = 0.7m 1sigma</p> <p><b>TUNNEL</b> scenarios:  <u>Conditions:</u>            Constant vel = 144 Km/h, tunnel duration 1 – 11 min.            Constant tunnel duration 5 min, vel = 252 Km/h  <u>Result:</u> Along track err &lt; 25m after 1000 sec in tunnel</p> <p><b>CURVE</b> scenarios:  <u>Conditions:</u></p>	<p><b>Lab tests</b>            HW in the loop laboratory tests performed with Spirent simulator and simulator of IMU.</p> <p><b>Field tests</b>            Live tests on train performed on the Torino-Chivasso line</p>	<p>Integrity monitoring performed at several levels</p> <p><b>Level 1: SENSORS PRE-PROCESSING</b>            Measurement diagnostics (exclusion or correction)            Checks with train dynamic constraints            EGNOS HPL            RAIM</p> <p><b>Level 2: DATA FUSION FILTER MODULE</b>            Information redundancy: Multi-sensors cross-checks            Measurement residuals            Filter covariance            Virtual Balise matching for divergence on travelled distance</p>



System architecture	Objective	Positioning-related Performances, specified and obtained	Model / characterization of the environment of reception and scenarios / tests considered in this environment	Integrity monitoring implementations and general safety aspects
		<p>Constant vel 20 m/s, curve radius 1-5 Km            Constant radius 2.5 Km, vel = 10 – 70 m/s            Constant vel 20 m/s, constant radius 1 Km, rotation angle 45°-360°  <u>Results:</u>            Along-track position err = 1m for each rad/sec of angular vel            Error immediately recovered at end of curve            Absolute ECEF pos err &lt; 1.5m</p> <p><b>LIVE TESTS ON TO-CHIVASSO</b> Route:  <u>Accuracy:</u>            Comparison with physical balise:            Balise-Rune err &lt; 1.5m (2sigma) along-track            Some sensors time stamp errors induced larger along track errors            Absolute position error with EGNOS availability: &lt;10m (2sigma)  <u>Availability during live tests:</u>            GPS no solution 20% time            GPS-only solution 35% time            EGNOS solution 45% time            Integrity calculation during live tests:            PDOP &lt;6, HPL &lt; 15m (peaks up to 27m)</p>		
<p><b>GIRASOLE</b>  <b>Multi-constellation receiver (GPS + GLONASS + Galileo)</b></p>	<p>Use of multi-constellation receiver prototype for railways</p>	<p>The project focused on the receiver development (not on a railway function).            From [47]:            -<b>Accuracy</b> requirements: 4m horizontal accuracy, vertical 8m with 95% confidence at least once every second, without any other aids            - <b>Velocity</b> accuracy requirement: 0.5m/s with 95% confidence level            -Local precision differential code position accuracy: 0.8m horizontal and 1.5 vertical with 95% confidence</p>		

System architecture	Objective	Positioning-related Performances, specified and obtained	Model / characterization of the environment of reception and scenarios / tests considered in this environment	Integrity monitoring implementations and general safety aspects
<p><b>GRAIL</b>  <b>GPS-EGNOS-</b>  <b>Galileo-ready</b>  <b>receiver to</b>  <b>enhanced/substitute the current</b>  <b>odometry subsystem</b>  <b>(tachometers, INS, Doppler radar, etc.) + beacon + IMU</b></p>	<p>Specification of a GNSS-based system for different integration levels of ERTMS/ETCS</p>	<p>at least once every second            - <b>Integrity</b>: the receiver shall provide a protected position error of 50m in every operating condition</p> <p>- <b>Availability</b> requirement: the specified accuracies shall be met for 95% of the time, in any place within the service volume, when operating in the Nominal SIS Constellation state            - <b>Continuity</b> requirement: the probability of service discontinuity predicted over the next critical operation period (15 sec TBC<sup>1</sup>) shall not exceed the specified value of 8.0E-5 (TBC) assuming an integrity requirement (without receiver contribution) of 8.0E-6 on 15 sec.            - <b>Integrity</b> requirement: the time-to-alert shall be better than 5 sec. (use of EGNOS for providing integrity)            - The <b>continuity</b> results were below the 5x10<sup>-4</sup> bound.            - The <b>accuracy</b> in position is less than 2m when comparing the navigation solution with the real position of the receiver            - <b>No integrity</b> failures were detected. The HPL global behaviour is &lt;12m and the VPL&lt;22m. These two values assure the availability of the service in terms of APV-1 alarm limits (40m in horizontal component and 50m in the vertical one) that are the ones fixed as goal to be achieved by the EGNOS System at 99% level of confidence and, consequently, fulfil the aeronautical requirements.            - In conclusion, <b>EGNOS</b> user performances obtained during the trials are:</p>	<p>- <b>Operational scenarios</b>:            ☐ 1. Train awakening and cold Movement detection: when a train is starting a mission with stored position data qualified as invalid or unknown, the GNSS system can qualify them as valid            ☐ 2. Absolute positioning: in order to provide a way to have a direct access on the positioning without integration of the speed. It gives the possibility to have a confidence interval on the travelled distance, independent of the travelled distance.            ☐ 3. Train Integrity: by placing a GNSS antenna at the rear of the train. The train integrity can be derived by comparing the distance ‘rear-front end’ with the length of the train            - <b>Tests</b>: Lab environment with simulation tools and on-site tests (rural and urban environments) between Madrid, Lleida, and Barcelona HS line. A total number of 30 GPS satellites were available during the trials with no <b>EGNOS</b> SIS occurred (some RIMS unavailability).</p>	<p>- <b>Safety</b> requirements:            ☐ at user level and system level for ETCS: Preliminary Hazard Log, Risk Analysis and quantification of safety requirements            ☐ at the subsystem level: Enhanced Odometry            - <b>Safety</b> analysis :            ☐ Safety requirements and Safety integrity Level allocation for the User Terminal and other components.            ☐ Proposal for the relevant test and analysis to demonstrate the validity of the safety design</p>

<sup>1</sup> TBC: To be confirmed

System architecture	Objective	Positioning-related Performances, specified and obtained	Model / characterization of the environment of reception and scenarios / tests considered in this environment	Integrity monitoring implementations and general safety aspects
		<ul style="list-style-type: none"> <li>☒ 100% Availability in APV-1</li> <li>☒ Accuracy below 2m</li> <li>☒ Integrity is ensured</li> <li>☒ Good stability of position and velocity determination</li> </ul>		
<b>GRAIL 2</b> (cf. GRAIL)	Developing an improved odometry subsystem based on GNSS for ERTMS/ETCS high speed lines ; based on GRAIL, progress in the implementation and testing to have user validation of the applications	<ul style="list-style-type: none"> <li>- <b>Accuracy</b> requirements:               <ul style="list-style-type: none"> <li>☒ Travelled distance accuracy required of <math>\pm(5m\pm5\% S)</math> (of travelled distance) independently of the speed and operational conditions</li> <li>☒ Confidence interval related to the "safe front-end" position of the train of <math>\pm(5m\pm5\% s)</math>. This confidence interval shall be given with a <math>4.891638*\sigma = 1 \times 10^{-6}</math></li> <li>☒ Speed accuracy of <math>\pm 2</math> km/h for speed <math>&lt; 30</math> km/h, then increasing linearly up to <math>\pm 12</math> km/h at 500 km/h</li> <li>☒ Speed confidence interval given with a <math>5\sigma</math> proba. (<math>1e-5</math>)</li> </ul> </li> <li>- <b>Availability</b> requirement: available 95% of the time</li> <li>- <b>Continuity</b> requirements: the probability of service discontinuity predicted over the next critical operation period (15 s) shall not exceed the specified value of <math>8.0E-5</math> assuming an integrity requirement (without receiver contribution) of <math>8.0E-6</math> on 15s.</li> <li>- <b>Integrity</b> requirements:               <ul style="list-style-type: none"> <li>☒ The final GNSS UT integrity shall be <math>&gt; 99.9999\%</math></li> <li>☒ The GNSS UT time-to-alert shall be less than 5s</li> </ul> </li> </ul>	<ul style="list-style-type: none"> <li>- An initial <b>environmental characterization</b> took place with analysis 2 GNSS equipment installed on the testing train. This enables a comparison of performance between two receiver types</li> <li>- <b>Tests</b>: in the rural and urban environments with:               <ul style="list-style-type: none"> <li>☒ GPS Single frequency without SBAS Integrity</li> <li>☒ GPS + EGNOS with Integrity</li> </ul> </li> <li>- The main <b>conclusions</b> of the test results were the no compliancy for:               <ul style="list-style-type: none"> <li>☒ Travelled distance accuracy</li> <li>☒ Confidence interval</li> <li>☒ Speed accuracy</li> <li>☒ Speed confidence interval</li> <li>☒ Availability</li> <li>☒ Continuity</li> <li>☒ Integrity and time-to-Alert</li> </ul> </li> <li>- <b>EGNOS</b> use and testing was planned but due to technical drawbacks actual trials were never carried out.</li> </ul>	<ul style="list-style-type: none"> <li>- <b>Error</b> considered: multipath rejection and mitigation techniques (e.g. antenna design, design of the receiver signal processing function) were implemented in the GNSS receiver, interference mitigation techniques were also implemented.</li> <li>- <b>Safety analysis</b>:               <ul style="list-style-type: none"> <li>☒ Safety Plan</li> <li>☒ Preliminary Hazard Analysis Report</li> <li>☒ Safety task related to life cycle</li> <li>☒ SIL Allocations and Hazard Rate Apportionment</li> <li>☒ User Terminal Safety Analysis</li> <li>☒ Approach to GNSS UT Integrity Analysis</li> </ul> </li> </ul>
<b>GALOROI</b> - <b>Galileo</b> receiver + <b>Eddy Current Sensors + map</b>	Development of an innovative localization	<ul style="list-style-type: none"> <li>- <b>Accuracy</b> requirement of the system: 1 m in standstill and it shall be dynamical in longitudinal direction according to the driven train speed (it does not exceed 25 m with the maximum velocity of 160</li> </ul>	<ul style="list-style-type: none"> <li>- <b>Tests</b> <ul style="list-style-type: none"> <li>☒ Lab tests for the components</li> <li>☒ Test drive to collect data and check the operability of all components.</li> </ul> </li> </ul>	<ul style="list-style-type: none"> <li>- <b>Safety aspects</b>: a thorough RAMS analysis and documentation is</li> </ul>

System architecture	Objective	Positioning-related Performances, specified and obtained	Model / characterization of the environment of reception and scenarios / tests considered in this environment	Integrity monitoring implementations and general safety aspects
<p><b>- redundant channels</b></p>	<p>system for low density railway lines</p>	<p>km/h)  <b>- Availability</b> requirement : the localisation system output must be available 99.98% of all cases and will identify the states when the system is not operational  <b>- Safety</b> requirement:            ☐ if 3 or less satellites are detected, a safety relevant reaction shall occur within 1 second in accordance of localisation accuracy, driven velocity, track topology (driving through switches) and danger points (clearance, level crossings, tunnels).            ☐ The digital map functionality and the odometry solution are relevant to the safety behaviour of the global system in case of standstill and when bringing the train back to operation, e.g. after a night standing in the depot.            ☐ The tolerable hazard rate for the localisation system is set between <math>10^{-7}</math> and <math>10^{-8}</math> (dangerous hazard per hour) in accordance to the SIL 3 objective.</p>	<p>Track-selectivity was obtained during these tests in most of the cases after 20-30 meters behind a switch (except once, when the algorithm was undecided between neighbouring tracks)            ☐ Tests of the new localization platform in real environment on a track in Czech Republic (line Opava východ to Hradec n.Moravici)</p>	<p>performed and includes:            ☐ the identification of the parameters of the developed localisation system allowing its RAMS evaluation,            ☐ the fault tree analysis of the localisation system,            ☐ the evaluation of the occurrence probability of hazards, compliance with SIL 3 has been proven according to the legal framework.  <b>- The safety case</b> has been carried out with an accompanying and concluding assessment. The approach enabled the project assessor to be aware of the status and safety relevant aspects during the whole time of the project.</p>
<p><b>SATLOC GNSS receiver + EGNOS + Odometer</b></p>	<p>Development and demonstration of innovative</p>	<p><b>Accuracy</b> requirements:            ☐ « along the track » ~5-15m [60], worst=10m (D1.1 Part 3)            ☐ No GNSS-based track discrimination</p>	<p>Experimental tests performed along a regional line in Romania (one tunnel, otherwise relatively free of obstacles area).</p>	<p>EGNOS is used for its integrity flag (Use/don't use) but no integrity monitoring tested.</p>

System architecture	Objective	Positioning-related Performances, specified and obtained	Model / characterization of the environment of reception and scenarios / tests considered in this environment	Integrity monitoring implementations and general safety aspects
	GNSS Safety in live rail application for the train control, speed supervision, traffic control and traffic management of low traffic lines (LTL)	<ul style="list-style-type: none"> <li>▫ Coverage of the track 99%– essential at the stationary points and « MA enforcement » areas.</li> </ul> <p><b>Safety requirements</b></p> <ul style="list-style-type: none"> <li>▫ Tolerable missing positions</li> <li>▫ IR&lt;2.5 10-7 for accuracy of 4m,</li> <li>▫ TTA 6s,</li> <li>▫ AL&lt;20m (EGNOS is sufficient)</li> <li>▫ OBU SIL2</li> </ul>	Simulation test performed in “critical points” in terms of masking effects with a combination of masking angles extracted from image processing and a signal simulator.	
<p><b>3inSat</b>  <b>Multi-constellation GNSS receiver + EGNOS + Odometer + IMU</b></p>	Development of a multi-constellation system compatible with ERTMS/ETCS through the virtual balise concept.	<p>LDS related requirements:</p> <p><b>1-Accuracy requirements:</b></p> <p>a)Position accuracy:</p> <ul style="list-style-type: none"> <li>• The expected Average Position Error per train run is less than +/- 3 meters-&gt;80% PASSED with the KPI average value of is -1,46 meters,</li> <li>• The acceptable related Mean Squared Position Error or Standard Deviation per train run is less than 4 meters.-&gt; less than 4 meters for about 99% of train runs</li> </ul> <p>b)Speed accuracy:</p> <ul style="list-style-type: none"> <li>• The expected Average Speed Error per train run is less than +/- 5 km/h.-&gt; PASSED for 99% train runs</li> <li>• The acceptable related Mean Squared Speed Error or Standard Deviation per train run is less than 6 km/h-&gt;all PASSED</li> </ul> <p><b>2-VB accuracy requirements:</b></p> <ul style="list-style-type: none"> <li>• The expected Virtual Balise Groups detected inside expectation window per train run is: &gt;99%.-&gt;100% train runs PASSED</li> </ul>	<p><b>- Operational scenarios:</b>            UNKNOWN/ VALID/ INVALID L2 SOM, -&gt;SR mode transition-&gt; FS mode transition            In three different IP based TLC scenarios:</p> <ul style="list-style-type: none"> <li>• Private TETRA network</li> <li>• 3G public bearer</li> <li>• SATCOM+3G multibearer</li> </ul> <p><b>- Tests:</b></p> <p>a) Lab tests, with simulation tools            b) On-site tests on the RFI Line Cagliari – S. Gavino line, 50 km length, with one train running in commercial service (7500km train runs equipped with LDS system, performing measurements).</p> <p>The analyses of KPIs including position errors with respect to a ground truth have confirmed the applicability of the GNSS technology in the railway domain for the</p>	<p><b>Safety aspects</b>            The aim of the safety analysis was to provide the relevant safety evidence of the GNSS based train LDS which would support its future verification, validation, elaboration of safety case and certification according to CENELEC railway safety standards (EN 50126, EN 50128, EN 50129, etc.).            The safety analysis was mainly focused on:            1) derivation of LDS safety requirements for ETCS Level 2</p>

System architecture	Objective	Positioning-related Performances, specified and obtained	Model / characterization of the environment of reception and scenarios / tests considered in this environment	Integrity monitoring implementations and general safety aspects
		<ul style="list-style-type: none"> <li>The expected Average Position Error of estimated Virtual Balises location per train run is less than +/- 4 meters%.-&gt;87% train runs PASSED</li> <li>The acceptable related Mean Squared Position Error of estimated Virtual Balises location or Standard Deviation per train run is less than 5 meters. -&gt;98% train runs PASSED</li> </ul> <p><b>3-Integrity requirements:</b></p> <ul style="list-style-type: none"> <li>% of epochs for which the Phase 2 LDS System does not provide a solution: less than 2%</li> <li>% of epochs for which the Phase 2 LDS System is potentially intrusive (Protection Level &gt; Application Threshold): less than 20%</li> <li>% of epochs for which the Phase 2 LDS System is in MI/HMI: less than 2%.</li> </ul> <p>→ PASSED for 99% train runs</p> <p><b>4-Availability requirements:</b></p> <ul style="list-style-type: none"> <li>The expected Delivered vs. planned Virtual Balises per train run is: more than 99%.</li> <li>The expected correct sequence of provided Virtual Balises per train run is: 100%.</li> </ul> <p><b>5-Safety requirements:</b> For each train run, the actual safe front end (based on the Ground Truth) must be never outside the train confidence interval for every measured distance from the applicable LRBGs.-&gt; 100% of train runs PASSED</p>	<p>implementation of the Virtual Balise concept.</p>	<p>platform, and 2) development of ETCS LDS</p> <p><b>Integrity monitoring.</b> A new safety concept of the multi-constellation EGNOS-R/ SBAS-R was proposed.</p> <p>The Wayside LDS Augmentation and Integrity Monitoring Network includes the LDS subsystem components installed wayside (i.e. Reference Stations, Track Area LDS Server and communication network).</p>
<p><b>RHINOS Multi-constellation</b></p>	<p>This project aims at</p>	<p>(Project at preliminary stage, started in 2016)</p>	<p><b>- Model linked to the environment:</b> Modelling of different railway</p>	<p><b>- Integrity monitoring implementations:</b></p>

System architecture	Objective	Positioning-related Performances, specified and obtained	Model / characterization of the environment of reception and scenarios / tests considered in this environment	Integrity monitoring implementations and general safety aspects
<b>receiver (GPS, Galileo, EGNOS, WAAS) + Advanced-RAIM</b>	increasing the use of EGNSS to support the safety-critical train localization function with a combination of GNSS, SBAS and ARAIM inspired from avionics and adapted to the difficult railway environments		environments to derive model of sky view and elevation masks relevant to obscuration and multipath effect on GNSS signals - <b>Operational scenarios:</b> nominal and extreme train scenarios including track geometry, train speeds, tracks changes, etc. - <b>Tests:</b> Virtual test bed to test GPS SIS fault events (satellite malfunctions and atmosphere anomalous behaviour), no field measurement campaigns	refining of integrity monitoring parameters with sensitivity analysis in function of the environment impacts and potential intentional interferences - <b>General safety aspects:</b> evaluation of hazards (e.g. Dangerous Detected, Dangerous Undetected) during the tests with rates statistics
<b>ERSAT EAV EGNOS and Galileo early services</b>	To develop a system solution for the train localization, verifying the suitability of EGNSS (including EGNOS and Galileo early services) for safety application in regional railway lines scenarios	The tests are in progress	High fidelity <b>simulation</b> of the full signal and data processing chain. The simulator allows the joint use of recorded data, as those acquired during a measuring campaign in a real railway environment or during infield tests, with data synthesized by signal generators providing ordinary as well as hazardous signal patterns. The simulator considers the relevant aspects of the surrounding environment, including satellite motion, SIS generation, GNSS signal propagation from satellites to ground receivers, navigation data generation, reception and interpretation, and train motion.  <b>Measurement campaign</b> and infield	Integrity monitoring networks consisting of two fixed ground reference stations networks, integrated with + EGNOS SBAS

System architecture	Objective	Positioning-related Performances, specified and obtained	Model / characterization of the environment of reception and scenarios / tests considered in this environment	Integrity monitoring implementations and general safety aspects
			tests in the Sardinia trial site along the regional railway line of RFI between Cagliari and S. Gavino stations are in progress	
NGTC	<p>The NGTC WP7 has been focusing on application of the satellite positioning functionality in the frame of ERTMS/ETCS (virtual balise concept). Activities have been based on the pervious results of the UNISIG Satellite Positioning Workgroup.</p>	<ul style="list-style-type: none"> <li>- Neither specification of positioning related performances nor the performance of measurement campaign was in the scope of NGTC.</li> <li>- Regarding the GNSS performances, a number of previous EU-funded rail research projects have been analysed. The conclusion made by the project was that the publicly available data/results don't allow to proceed with the full virtual balise System Requirements Specifications for ERTMS. The recommendation from the NGTC was to perform an extensive GNSS test campaign focused on the positioning performance aspects in a follow-up research program.</li> <li>- For the analyses performed within the project, NGTC experts have been working with an assumption of 50 meters GNSS based position accuracy.</li> </ul>	<ul style="list-style-type: none"> <li>- Specification of the GNSS receiver parameters (and accompanying test methods) that is relevant for an interoperable signalling application such as ERTMS.</li> <li>- Specification of GNSS performance assessment methods in the scope of railway environment. Defined procedures based on a simulation of the key GNSS effects relevant for the Virtual Balise application.</li> <li>- Considerations relevant for ERTMS operational scenarios using virtual balise.</li> </ul>	<ul style="list-style-type: none"> <li>- Investigation of the physical phenomena that can affect the GNSS signals (qualitative analysis);</li> <li>- Analysis of the impact of the physical phenomena that can affect the GNSS signals (resulting from previous) on VBR function has been investigated (qualitative analysis);</li> <li>- Definition of a set of relevant operating scenarios in which VB is applied;</li> <li>- Analysis of the case studies taking into account the physical phenomena that can affect GNSS signals;</li> <li>- Development of a preliminary VBR</li> </ul>



System architecture	Objective	Positioning-related Performances, specified and obtained	Model / characterization of the environment of reception and scenarios / tests considered in this environment	Integrity monitoring implementations and general safety aspects
				<p>architecture independence evaluation (quantitative analysis):</p> <ul style="list-style-type: none"> <li>- Development of a VBR preliminary FMEA and functional apportionment (quantitative analysis);</li> <li>- Specification of definitions for parameters for system performance, addressing incongruences across GNSS, aviation and railway disciplines;</li> <li>- Considerations on EGNOS Service Provision;</li> </ul>

### 3.3 REVIEW OF SOLUTIONS

#### LOCALISATION UNITS VERSUS GLOBAL SYSTEMS

Two approaches can be found in the past projects. Some of the projects decided to develop an OBU (On Board Unit) with a very high level of integrity. This is the case of GaloROI (SIL3) or 3inSat (SIL4). In some others, the safety is ensured by the global operational system. The pressure is then lower on the localization unit as in Satloc where the SIL is reached thanks to a double check of position coherence between the train and the track control centre.

#### GNSS AS A FIRST SENSOR

If GNSS is never a stand-alone solution, a GNSS receiver is included in all the experiences recalled in this document. Several declination of GNSS receiver can however be used.

The simplest configuration is a simple GPS receiver. Such a receiver only receives GPS signals, i.e. signals sent by satellites of the US constellation.

In the European projects, funded by European programs, EGNOS has been at least tested, so the receiver employed were most of the time EGNOS/GPS receivers. But due to visibility difficulties (GADEROS), technical constraints (GRAIL2), some of these projects only used the GPS data of such receivers... But when received, EGNOS shows its interest on accuracy as demonstrated in Locoprol figure 6 [45] where a bias of 1m exists in the measured position error in both cases of EGNOS and no EGNOS monitoring. Error here is computed by comparison of the estimation with a reference track database.

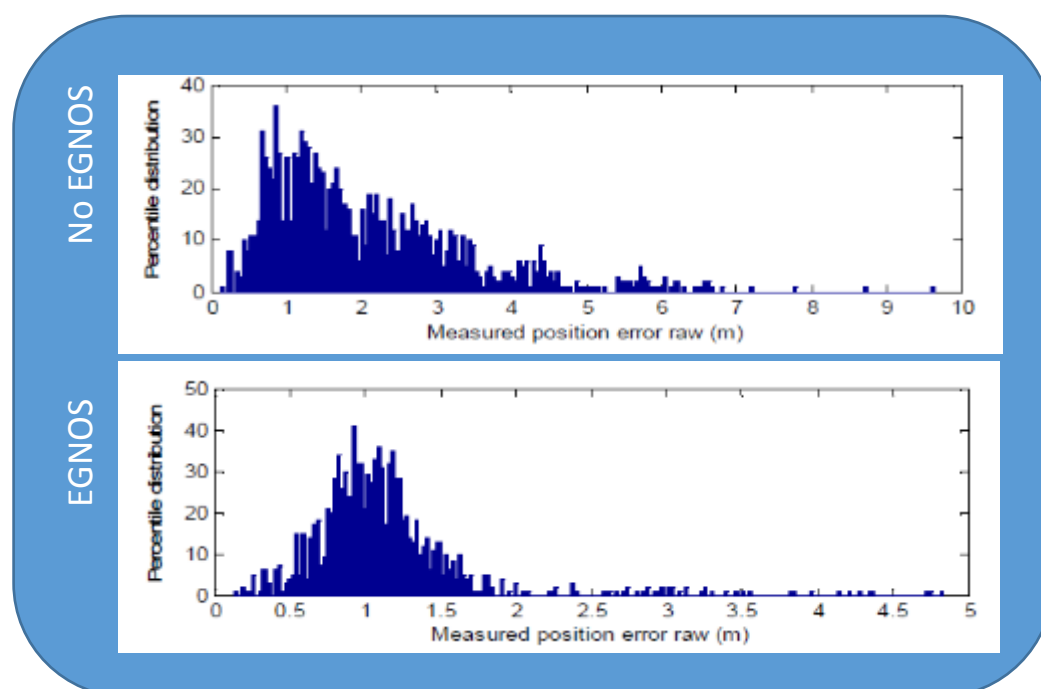

Figure 6: Estimated positioning accuracy with and without EGNOS along an Italian High speed railway line [45].

GPS RTK has been mentioned in some projects. RTK provides very accurate positions thanks to real-time kinematic corrections. The RTK requires a fixed receiver (base) that provides phase correction via a communication link. Because of its high cost, the need for initialization period, and continuous communication link, RTK is more used as an evaluation tool (for reference trajectory) than as an embedded long-term solution.

More recent projects are exploring the potential of multi frequency and multi constellation systems available today because of the multiplicity of the systems (Glonass, Galileo, Beidou...) and the new signals embedded in new generation of satellites. In 3inSat, multi constellation receivers are used in order to increase accuracy and satellite visibility. Integrity monitoring of all constellation is achieved by a track augmentation network [10].

In 2005, the GIRASOLE project proposed the development of a dedicated receiver for safety of life applications and in particular one for the rail. This receiver has been tested in the GRAIL project.

LOCOPROL relied on GNSS also but without exploiting the classical output of a GNSS receiver. The original LOCOPROL algorithm exploits, in the one hand, the 1D characteristic of a track and, in the other hand, pseudo ranges from pairs of GPS satellites assumed. Based on TDOA (Time Difference of Arrival), the algorithm computes positioning by intersecting hyperboloids with the track data base. Each pair and its intersection provide a position interval on the track. The merge of all the intervals computed is the choice made to ensure a high confidence to the final interval (PCI – Position Confidence Interval [11]). For more robustness, the solution has been hybridized with an odometer as most of the following solutions.

### MULTI SENSOR LOCALISATION SOLUTIONS

Even if not necessarily quantified, most of the solutions adopted in projects aim at ensuring a maximal availability and accuracy and/or integrity. The “or” are used here because of the different targets defined in the projects. LOCOPROL for example, highlighted the need for integrity more than accuracy on the targeted low traffic lines. In this section, the presentation is classified into availability and accuracy-related solutions first and safety-related solutions then but keeping in mind that accuracy and availability performance contribute to integrity and safety.

Everybody knows today that GNSS-alone cannot reach availability and high accuracy in constraining environments, neither a high level of safety integrity as expected for railways. Indeed, unlike a plane, a train travels close to various obstacles for the signals: buildings, trees, cuttings or even tunnels, etc. that create multipaths or blockages of satellite signals. Thus, different solutions have been developed from classical to more original ones to counter these effects.

GBAS or SBAS can be used for their accuracy and specially integrity enhancement capabilities. Their use will be discussed in section 4 of this document.

In the first projects like GADEROS [7] or APOLO [12] the systems developed combined multi sensor inputs to allow the system to benefit from absolute localization solutions with GPS as well as with continuous and high frequency localization thanks to inertial measurements (as for the classical road or robotics solutions). Usual sensors are odometers and gyroscope, i.e. in APOLO and GADEROS, or Inertial Measurement Units (IMU), i.e. in Integrail but one can also find Eddy

current sensors like in the papers of [13] [14] and in the GaloRoi project [17]. In these projects, an OBU is developed where sensors inputs are fused by the way of a Kalman Filter.

As an example, the solution developed in the RUNE project implemented a Navigation Kalman Filter (described in [18]) that integrates data from three main on-board sensors:

- GNSS Receiver: provides a GPS/EGNOS-based PVT solution in addition to EGNOS integrity data;
- Inertial Measurement Unit (IMU): provides three-axis accelerometer and three axis gyro data for propagation of the solution, especially in case of unavailability of GNSS signals;
- Train Odometer Unit: provides continuous along-track velocity information from two toothed wheels.

Fusion techniques are discussed in [15][21][22][13] as well as fusion levels (loosely-coupled or deeply-coupled integration) in [23]. The level of fusion defines whether the raw GNSS data (like pseudoranges) are used as inputs in the navigation filter or the GNSS receiver output.

These fusion techniques are sometimes complemented with digital maps as frequently done in automotive applications [24][21][25][26] [19]. One shall notice, of course, that their use implies availability, accuracy, reliability, and consistency of the maps [16]. [27] proposed a modelling scheme for generating a digital map.

[28] explains a novel double difference algorithm for train location determination that explicitly accounts for the track constraint. Discussions about the required accuracy of the map for an efficient fusion are discussed by [19].

In [29], the track database is not used for map-matching but, instead of a classical PVT, the train position has to be placed on the track network by topological coordinates. The coordinates are a triplet composed of the track ID, the track length and the direction of the train. The objective in this study is the track selectivity.

Let's notice also that, for Virtual Balise<sup>2</sup> concepts as in RUNE, 3inSat or ERSAT EAV, a map is mandatory in order to record Virtual Balises positions. The Virtual Balise is one of the topics of the NGTC project where operational scenarios with virtual balise applicable for ERTMS and the link Database have been defined. Moreover, NGTC proposes a preliminary functional architecture for ERTMS virtual balise concept presented figure 7. Safety concept and safety analysis have been started in the project [57]

---

<sup>2</sup> Virtual Balise concept consists in the abstraction of all or part of physical ETCS balises along the track. Their position has to be referenced in a map so that the train could detect when it is travelling over a balise

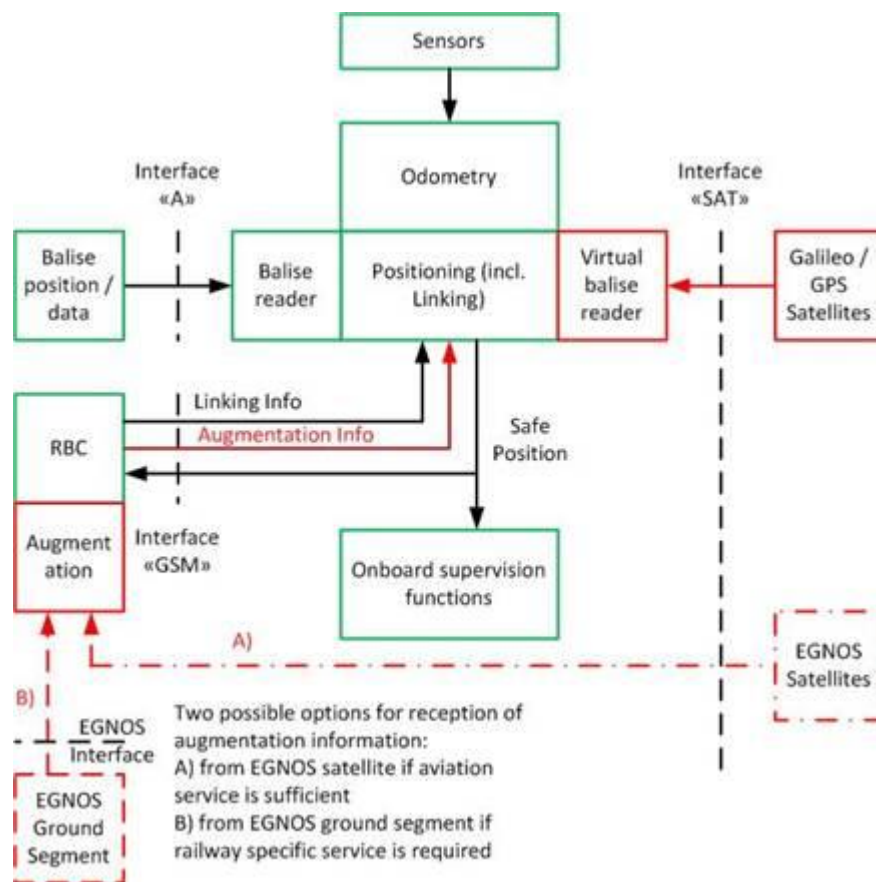

Figure 7: NGTC preliminary functional architecture for ERTMS virtual balise concept

With a different approach, the EATS (ETCS Advanced Testing and Smart Train Positioning System) solution, instead of usual sensors, integrates GNSS with wireless communications technology (WCT) positioning. WCT relies on GSM-R (GSM for railway) and UMTS mobile communication systems [20] and improves in particular availability.

**SAFETY-FOCUSED STRATEGIES**

Safety is ensured by specific strategies. In aeronautics, safety is linked to integrity monitoring. Integrity monitoring ensures the user GNSS solution can be used as a primary navigation system in safety conditions. This monitoring can be realized by three different systems having each their own monitoring methods: RAIM (Receiver Autonomous Integrity Monitoring), SBAS or GBAS. The difference between these methods is that SBAS and GBAS broadcast data usable by the receiver to compute in real time its integrity (with a protection level), although in RAIM, the receiver has to perform it alone. A posteriori, the integrity risk probability ensured using the monitoring method can also be computed.

As GBAS and SBAS have been introduced before, let's describe here the main principles of RAIM. A RAIM algorithm is contained within the receiver. It consists in performing a consistency check on the satellite measurements in order to detect a fault (important bias in a pseudo-range). This check requires the reception of 5 satellites simultaneously. FDE (Fault Detection and Exclusion) is an extension of RAIM and requires 6 satellites minimum. FDE excludes the faulty satellite after its detection and allows the system to continue to ensure integrity thanks to this exclusion. RAIM

inputs are the measurement noise standard deviation  $\sigma_{URE}$ , the measurement geometry, and fixed probabilities of false alarm  $p_{fa}$  and missed detection  $p_{md}$ . The output is either a fault detection, either a protection level  $PL$ , (vertical and/or horizontal), that will assure that the true position is contained in a circle with the given  $p_{fa}$  and  $p_{md}$ . The reader interested will find more details in [30] or directly in the aeronautical specifications (RTCA). RAIM has been applied in RUNE.

In the railway-related literature, safety strategies can be classified into three families of techniques.

The first family relies on **redundancy**. Redundancy (often with a voter) allows the system to detect incoherent measurements. In this family, GaLoROI hybridizes GNSS with an eddy current sensor and uses architecture redundancy (with independent channels) [17] (figure 8). As in GRAIL2, the 2 channels are associated to a vote (in safe controllers) in order to check consistency between channels [31]. The GRAIL2 architecture is represented in figure 9.

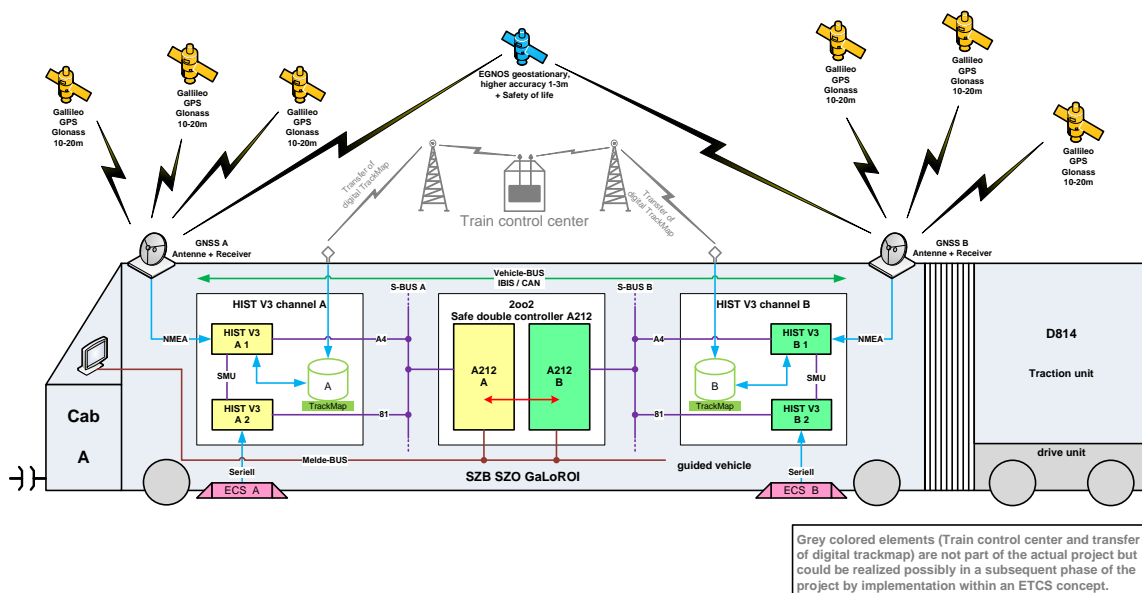

Figure 8: GaLoROI localization unit vehicle equipment [17].

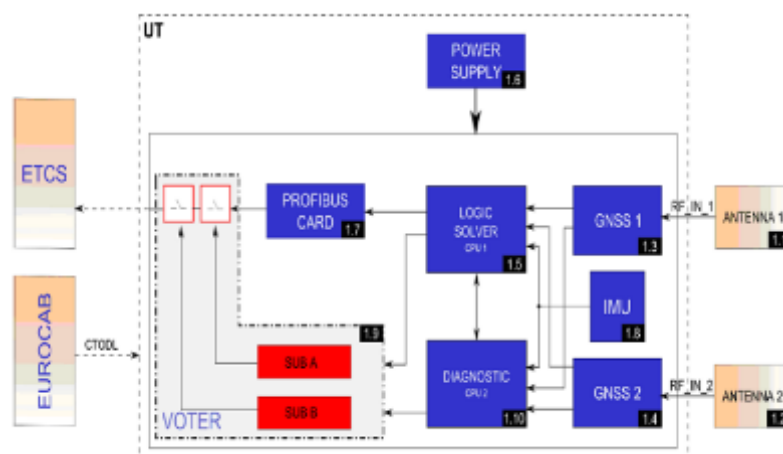

Figure 9: SIL2 architecture of the GRAIL2 project [31].

The second family is based on RAIM and/or **fault detection and exclusion** (FDE) algorithms introduced before. Since the early introduction of GNSS in railway, fault detection algorithms have been proposed. In 1998 [32] proposed a Fault Detection and Isolation in Multisensor Train Navigation Systems for new Automatic Train Control (ATC) and Automatic Train Protection (ATP) systems based on Chi-square test and residual test. Results of the fusion with real data have been presented in [33]. In the LOCOPROL project [34] wrote into equations the RAIM application on the 1D positioning developed in the project with an FDE in order to preserve a high constant integrity level by excluding unbounded additional biases.

More recently, [35] implemented a fault detection and diagnosis (FDD) process for integrity insurance. Its architecture is represented figure 10.

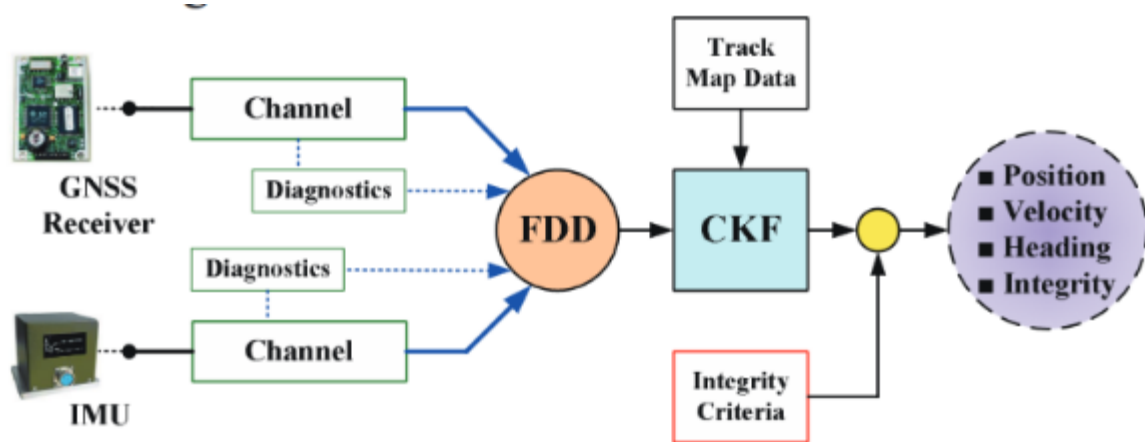

Figure 10: High integrity architecture of GNSS/INS positioning with Fault Detection and Diagnosis based on Principal Component Analysis [35]. CKF is a cubature Kalman filter, variation of the Kalman filter.

[64] Proposes an Autonomous Integrity Monitoring and Assurance (AIMA) scheme for a multisensory positioning system (accelerometer, gyroscope, odometer, GNSS). The fault detection and exclusion process is composed of three layers: before data fusion, before map-matching and before position report as summarized on figure 11.

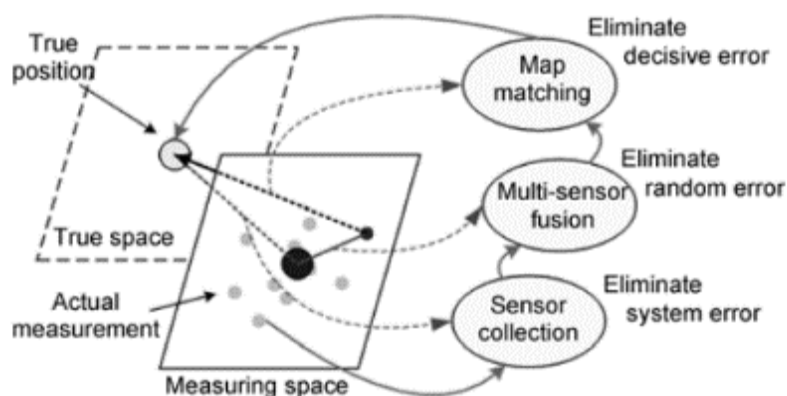

Figure 11: Flowchart of AIMA-aided GNSS-based train integrated positioning [64]

[36] Published a method of positioning errors detection based on a comparison of the GNSS-based altitude determination and the planned altitude contained in a 3D track-map. Based on simulations, he shows that GNSS errors in horizontal plane can be detected by test of mean (T-test) and variance (F-test) applied on vectors in “altitude matrix”.

Dealing with GNSS satellites only, [65] performs a series of checks in order to detect potential corrupted signals or positions: weak signals rejection, use of two antennas on a coach to compare pseudo ranges, verification of the pseudo ranges by signal Doppler frequency of the carrier... [38] Develops a vision-based tool capable of detecting NLOS (Non-Line-of-Sight) signals. Indeed a camera placed over the roof of the train provides images of surroundings of the antenna. Early stages of this work were based on classical lenses [37]. Latest rely on fish-eye lens that provides images of the 360° surroundings of the antenna. Image processing techniques are then applied in order to classify areas in sky and non-sky areas and thus LOS or NLOS satellites as illustrated on figure 12.

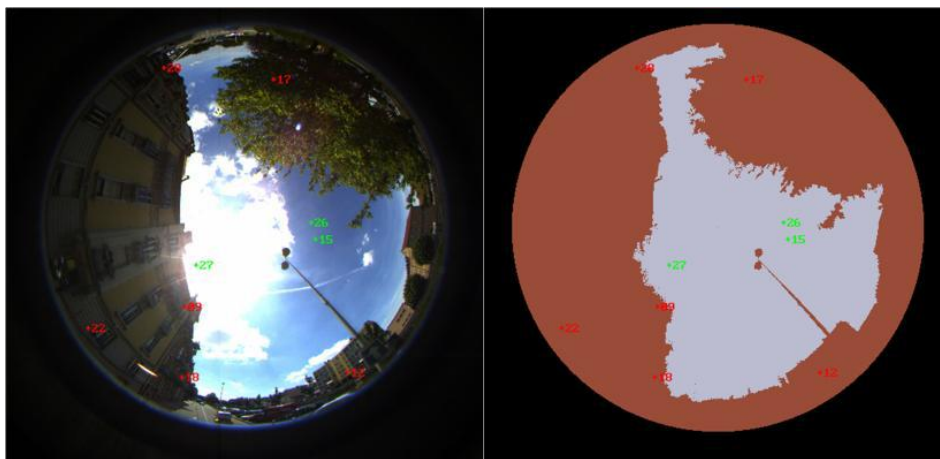

Figure 12: Illustrations of the satellite state detection in a fisheye image on the original image and on classified regions [40].

As evoked in the perspectives of [39] in a guided-bus application, the fact that a train is guided on tracks with a prior knowledge of its trip can let us imagine that an embedded database could allow registering some pre-recorded GNSS-related data. In this study, the idea was to record GNSS satellite availability. More recently it has been shown that a pre-knowledge of satellite-states of reception can increase accuracy of the GNSS-only solution [40]. In [41], an off-line RAIM availability prediction is proposed to compensate RAIM unavailability along the line.

The third family is based on **EGNOS**. As an SBAS, EGNOS allows the receiver to compute a HPL based on error boundaries sent by the geostationary satellites. The use of EGNOS for safety services induces the use of its integrity monitoring service. This has been tested in RUNE, GRAIL and will be one of the integrity monitoring elements of RHINOS. This is the focus of section 4.

### 3.4 SYNTHESIS

This chapter reviewed the main previous initiatives aiming at introducing EGNSS in railway signalling systems. The table summarizes their objectives and the realization for the positioning unit. All of these projects worked in an ERTMS/ETCS context.



In general, the added value of EGNSS in a train localization solution was shown to be of different natures:

- Ability to be integrated in an existing control/command system or in one to be conceived to substitute the current on-board odometry or, to replace trackside balises with virtual ones,
- Being sufficiently performing to reach requirement defined for low-traffic lines,
- To be combined with innovative technologies or low-cost technologies.

As no EGNSS solution on its own is able to provide sufficient accuracy and integrity especially in constrained environment settings (urban, woodland, etc. ...), the proposed solutions rely on GNSS first but always complemented with a variety of sensors (from Eddy Current to classical odometer) in order to offer both accuracy and a certain level of confidence in the position for safety purpose. The different architectures have been described in section 3.3.

They have shown that safety is a major issue since classical solution developed before in aeronautics do not always fit to railway constraints as RAIM that requires high satellite availability.

EGNOS, the European SBAS has been developed by Europe in order to ensure integrity of positioning. The next chapter will focus on its application in the railway context.

## 4 DISCUSSION ON THE SUITABILITY OF INTEGRITY CONCEPTS IN RAIL ENVIRONMENTS

As introduced in section 2, most of integrity monitoring solutions relies either on GBAS or SBAS. In this section, previous experiences on integrity monitoring with both systems are analysed.

### 4.1 IDENTIFIED EXPERIENCES

#### 4.1.1 GBAS-based integrity concepts

##### POSITIVE TRAIN CONTROL (PTC) AND NATIONWIDE DGPS (NDGPS) IN THE US

If, at the beginning of its study, NDGPS was candidate as a support to PTC in the United States, it seems that this use is no more on the agenda since in 2013; the Federal Railroad Administration (FRA) eliminated an NDGPS requirement from its PTC program.

Augmentation shall be based on SBAS (the American WAAS) and a network of continuously operating reference stations (CORS) from the National Geodetic Survey<sup>3</sup>.

##### 3INSAT

The 3inSat project<sup>4</sup> developed an architecture based on the complementarity of both ground and satellite-based augmentation systems in order to develop the railway requirements related to a satellite-based train positioning system and meet the expected demand from both the international and European Community market evolutions. Five target areas have been identified to derive specific user requirements as guidelines to the definition of a standard configurable platform tailored for each of the five main areas. Project Objectives were:

- On the positioning domain: design and develop a satellite-based Location Determination System (LDS) prototype, integrated with ERTMS, that guarantees the ERTMS SIL4 Train Position function.
- On the telecommunication domain: design and develop an integrated radio telecommunication solution based on the combination of SatCom, Public Packet Switched Networks and TETRA to be used as the alternative solution to GSM-R.
- To validate both LDS and Telecom solutions by a Field Demonstrator tailored to a freight scenario derived by the Australian scenario in a Railway Trial Site developed in Sardinia on the Cagliari San Gavino 50km line.

3InSat developed an ERTMS Enhancement for introducing GNSS and SatCom Technologies to meet the following high level requirements:

- Backward compatibility

---

<sup>3</sup> <http://gpsworld.com/ndgps-destined-for-the-technological-boneyard/>

<sup>4</sup> Final Presentation- ECSAT, Harwell, 25 February 2016

- SIL 4
- Cost Effective solution
- Limiting the impacts on ERTMS, hazard analysis, operations, and certification process.

Since meeting these requirements with the sole GNSS technology is very hard as demonstrated by previous projects, 3InSat investigated how to use GNSS technology with well-defined ERTMS mission profile and ERTMS operation concepts with reference to physical balises requirements:

<b>THR for failure of balise group detection</b> (at least 2 balises)	<b>1.0E-7</b> dangerous failures / hour (on-board) <b>1.0E-9</b> dangerous failures / hour (trackside)
<b>THR for cross-talk of balise group</b>	<b>1.0E-9</b> dangerous failures / hour
<b>Balise detection accuracy</b>	±1m

Virtual balise concept has been exploited: a) to provide data for localisation of the train, b) to reset the train confidence interval and c) to provide information under Application Conditions that reduces Integrity and Accuracy requirements on GNSS. The generic GNSS architecture is based on:

- Multi-constellation GNSS capability, exploiting existing constellations,
- Deployment of a dedicated Track Area Augmentation and Integrity Monitoring Network with very high availability (GPS only solution selected for the Australian scenario) similar to GBAS architectures but much less expensive,
- Independent on-board capability to further mitigate GNSS errors and autonomously assess the GNSS location integrity.

In essence the Track Area Augmentation and Integrity Monitoring Network plays a role similar to the EGNOS Range and Integrity Monitoring subsystem. In fact, processing of satellite signals received at known locations allows to estimate the error sources affecting train positioning and to detect eventual GNSS faults. The major difference with respect to EGNOS consists in a denser spatial deployment of the RIM RSs, compensating for milder requirements (and lower cost) on the GNSS receiver clocks and in the use of the wireless network employed for train signalling for broadcasting augmentation data to the on-board LDS.

The LDS Safety Server monitors for each epoch the measured pseudo ranges and compares them with the nominal values corresponding to the known antennas locations.

To enhance the systemic satellite fault detection capabilities, as well as to detect eventual RIM RS faults, their outputs are jointly processed by a Track Area LDS Safety (TALS) server. Such architecture allows improving the correction function of classical differential GNSSs and mitigating the risk of failure relevant to the GNSS reference stations.

Correction factors and more in general augmentation data are supplied to the mobile LDS OBUs in the service region by means of a safety-critical protocol layered on the same radio communications

network used for train control. This allows LDS to achieve a high degree of accuracy and integrity without depending on commercial off-the-shelf systems of unknown integrity.

RIM RSs are deployed in such a way that they share sources of systemic errors with the GNSS receivers on board of the locomotives operating in the regions, such as incremental delays caused by atmospheric conditions and ephemerides and clock errors of visible satellites.

### 4.1.2 **SBAS-based integrity concepts**

For the projects before 2005, due to the fact that a lot of satellites were not monitored at that moment by Egnos, it was not taken into account in the computations to avoid a problem of satellites availability. It is the case of GADEROS or LOCOPROL [61]. EGNOS has been declared fully operational in 2005 (and certified in 2010).

- Moreover, GADEROS faced availability difficulties due to instability of EGNOS at the period of the project and visibility difficulties along the track (bad orientation of the track compared to the GEO satellite positions)
- GRAIL used it for integrity provision on the basis of the APV 1 classification of aviation.
- GRAIL 2 was based on EGNOS by “adjusting” the Protection Level of aviation to a one-dimensional scenario of the rail line. However in the GRAIL-2 the GNSS was considered as an additional sensor of the Odometer to replace the Doppler radar.
- RUNE was conceived to take advantage of the EGNOS integrity and wide area differential correction service and extend its availability through a hybrid navigation system based on a Navigation Kalman Filter that integrates data from other main on-board sensors.
- As explained in the previous section, the GBAS-like mode is the primary source of integrity monitoring developed in 3InSat for areas where SBAS systems are not available. Instead, when SBAS are available, 3InSat architecture can use it as a sort of back-up solution when the GBAS is not available either.
- ERSAT EAV objective is to verify the suitability of EGNSS (including EGNOS and Galileo early services) with a generic augmentation network based on EGNOS and local Augmentation networks deployed to support also applications in other SoL domains.
- SATLOC uses the integrity output computed by the receiver as implemented in the receiver (as tuned for aviation applications). Moreover only positions qualified by EGNOS have been used, thus as a satellite fault detection system (“use” flag).

We can find HPL values along tracks in some project deliverables or papers. RUNE showed a mean HPL value is in the order of 10m along Torino-Chivasso Route [18].

None of the projects, based on reusing the EGNOS certified receivers, compared the HPL as provided by the receiver for aviation application to the true HPE to observe if error estimation was correct.

### 4.1.3 Combination of SBAS and GBAS

To reach Integrity Monitoring target and ensure availability, 3inSat propose an LDS (Location Determination System) architecture, based on (i) a multi-constellation capability to increase both the accuracy and the number of satellites in visibility , (ii) the deployment of a Track Area Augmentation and Integrity Monitoring Network (AIMN) with very high availability, and (iii) an independent on-board capability to further mitigate GNSS errors and autonomously assess the GNSS location integrity when augmentation data are unavailable [10]. Its architecture is presented in figure 13.

The network includes Ranging & Integrity Monitoring Reference Stations (RIM RS), for the purpose of integrity monitoring and accuracy improvement of satellite-based position. Each reference station provides correction services and detects systematic satellite faults [5].

The chosen modes are organized as follows:

- When a GBAS-like system with RIMs distributed along a track is deployed, the receiver will operates with it whenever the augmentation data provided by the TALS server are available.
- The SBAS system will be considered as a primary source of augmentation data when a GBAS system with RIMs distributed along a track is not deployed or unavailable.
- Due to the greater latency introduced by direct connections to the operational centres providing SBAS augmentation data over terrestrial links and redistribution over the Train Signalling Network, w.r.t. the use of SBAS SIS data, this mode will be activated whenever the two first modes are unavailable.
- Stand-alone GNSS is selected whenever the other modes are unavailable

[43] shows, during a test campaign along an important highway in the city of Rome, that using EGNOS system, the position errors are, on average, lower than using AIMN system (figure 14), but conclude also that in presence of tunnels and overpasses, the proposed augmentation network has lower position errors due to a better (local) compensation of local effects, i.e. ionosphere errors and multipath.

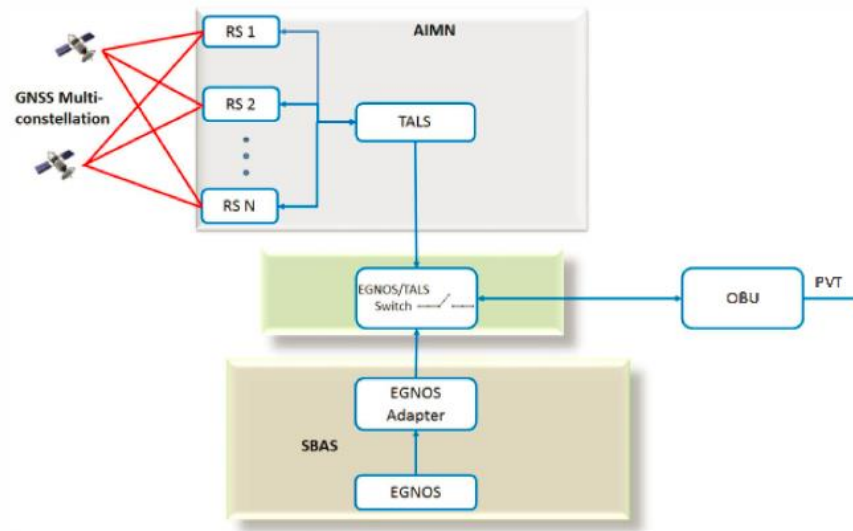

Figure 13: Overview of GNSS LDS System [43].

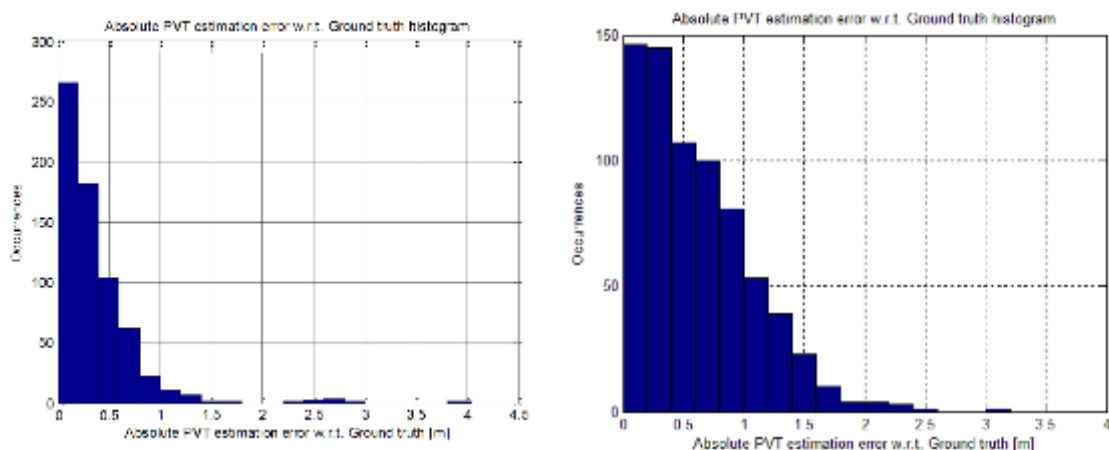

Figure 14: Histogram of position estimation error. Left: Only EGNOS mode, Right: Only TALS Mode [43].

RHINOS

This work will be consolidated in the RHINOS H2020 European project that aims to develop a Railway High Integrity Navigation Overlay System to be used by the rail community as a combination of GNSS, SBAS and ARAIM assets made available for the avionics applications world-wide [55].

The main objectives of the project are the following:

**Objective 1:** To define architecture of a train Location Detection System (LDS) and the supporting infrastructure based on the joint use of GPS and GALILEO. This will ensure:

- A standard interface for providing Safety of Life services for railways,
- Compliance with European railway requirements and regulations;

- Exploitation of existing GNSS infrastructure and on-board processing developed for aviation.

**Objective 2:** To assess the performance of the defined architecture by means of:

- A proof-of-concept integrating, in a virtual testbed, rich sets of data collected in a real railway environment and laboratories such as those at Stanford and Nottingham,
- Appropriate analytical methods for the verification and safety evidence of the defined architecture according to relevant railway safety standards.

**Objective 3:** To contribute to the missing standard of integration of GNSS-based LDS, into ERTMS, by publishing a comprehensive guide on how to employ, in a cost-effective manner, GNSS, SBAS and other local infrastructures in safety related rail applications worldwide, and by defining a strategic roadmap for the adoption of an international standard based on the same guide.

The RHINOS project is at preliminary stage so no results are available.

#### 4.2 IDENTIFIED OR KNOWN EGNOS LIMITATIONS [48]

Due to its system design and the geostationary of its satellites, EGNOS have some limitations, in particular in land transport applications. Main identified causes are referenced in EGNOS Open Service (OS) - Service Definition Document. Their table is reproduced here below.

Root Cause	Most Likely Symptoms
<p><b>Broadcasting Delays</b></p> <p><b>One of the functions of EGNOS is to elaborate a model of the ionosphere and to broadcast this model to users so that they can correct the related errors. When using the SBAS standard, the reception of all the parameters that are necessary to build such a model may take up to 5 minutes to be received, depending on the receiver.</b></p> <p><b>Therefore, the full positioning accuracy may not be reached as soon as the receiver is turned on.</b></p>	<p>EGNOS SoL Service Not Immediately Available</p> <p>The receiver does not immediately use EGNOS to compute a navigation solution and therefore the position accuracy improvement is not available until a few minutes after the receiver is turned on.</p>
<p><b>GPS or EGNOS Signal Attenuation</b></p> <p><b>The receiver power level of GPS and EGNOS signals is extremely low. Using satellite navigation under heavy foliage or in an indoor environment will weaken further the signals up to a point where the receiver will either lose lock of such signals or have a</b></p>	<p>Degraded Position Accuracy</p> <p>The position solution may demonstrate instability with higher error dispersion than usual. It may also be affected by sudden jumps when satellites are lost due to excessive attenuation. The performance of the receiver in such a difficult environment may be improved</p>

<p><b>much degraded performance.</b></p>	<p>with a high quality receiver and antenna design.</p>
<p><b>EGNOS Signal Blockage</b></p> <p><b>The EGNOS signals are broadcast by two geostationary satellites. This ensures some level of redundancy in case a satellite link is lost due to shadowing by a close obstacle (e.g. local orography or buildings). In addition, when moving North to high latitudes, the geostationary satellites are seen lower on the user’s horizon and therefore are more susceptible to masking.</b></p> <p><b>At any latitude, it may happen that, in an urban environment, the EGNOS signals are not visible for some time.</b></p>	<p><b>Degraded Position Accuracy After Some Time</b></p> <p>The effect of losing the EGNOS signal (on both GEOs) on the receiver will be equivalent to reverting to a GPS-only receiver. The navigation solution will still be available but will demonstrate a degraded accuracy since no clock ephemeris or ionospheric corrections will be available to the user receivers.</p> <p>However, such degradation will not be instantaneous since the SBAS standard has been designed to cope with temporary signal blockages. The exact time the receiver can continue to provide good accuracy in case of the loss of signal depends on the receiver design.</p>
<p><b>Local Multipath</b></p> <p><b>In urban environments, the GPS and EGNOS signals will be prone to reflections on nearby objects (building, vehicles...). This may cause significant errors which cannot be corrected by the EGNOS system due to their local nature.</b></p>	<p><b>Degraded Position Accuracy</b></p> <p>The navigation solution will tend to meander around the true position and may demonstrate deviations of a few tens of metres. This effect will have a greater impact on static users or in those users moving at slow speed. High-quality receiver and antenna design is able to attenuate the effect of multipath in some specific conditions.</p>
<p><b>Local Interference</b></p> <p><b>GPS and EGNOS use a frequency band that is protected by the International Telecommunication Union (ITU).</b></p> <p><b>However, it is possible that in some specific locations, spurious transmissions from services operating in adjacent or more remote frequency bands could cause harmful interference to the satellite navigation systems.</b></p> <p><b>In most cases, national agencies are in charge of detecting and enforcing the lawful use of spectrum within their national boundaries.</b></p>	<p><b>Degraded position accuracy or complete loss of service.</b></p> <p>Depending on the level of interference, the effect on the user receiver may be a degradation of the position accuracy (unusual noise level affecting the positioning) or a total loss of the navigation service in case the interfering signals preclude the tracking of navigation signals.</p> <p>The detection, mitigation and control of potential spurious transmissions from services operating in frequency bands that could cause harmful interference and effects to the satellite navigation systems (degrading the nominal performances) is under the responsibility of</p>



	local authorities.
<p><b>Ionospheric Scintillation</b></p> <p><b>Under some circumstances due to solar activity and in some specific regions in the world (especially for boreal and subtropical latitudes), ionospheric disturbances (called scintillation) will affect the GPS and EGNOS navigation signals and may cause the complete loss of these signals for a short period of time.</b></p>	<p>Degraded position accuracy</p> <p>The position solution may be affected by sudden jumps when satellites are lost due to scintillation.</p> <p>If the number of tracked satellites drops seriously, a 3-dimensional position may not be available. Eventually, the navigation service may be completely lost in case less than 3 satellites are still tracked by the user receiver.</p> <p>In cases when only the EGNOS signal is lost, the impact will be similar to the one described for “EGNOS signal blockage” above</p>
<p><b>Degraded GPS Core Constellation</b></p> <p><b>The GPS constellation is under continuous replenishment and evolution. On rare occasions, it may happen that the basic GPS constellation becomes temporarily depleted and that it does not meet the GPS SPS PS commitment.</b></p>	<p>Degraded EGNOS SoL Service performance</p> <p>In such a case, the EGNOS OS performance can be degraded. The performance experienced by the receiver may be worse than the minimum performance indicated in section 6.2.1.</p>
<p><b>GEO Satellite Orbit inclination</b></p> <p><b>The characteristic orbit of the GEO satellites may be degraded (e.g. high inclination).</b></p>	<p>Degraded availability performance</p> <p>In this situation, some far North regions of the service area may be covered with only one GEO during some periods of the day and may experience some degradations in availability performance.</p>

### 4.3 EGNOS LIMITATIONS IN THE RAIL ENVIRONMENT

In order to illustrate some of the events described above, the following paragraphs illustrate the experience mentioned by the past projects or papers.

#### 4.3.1 EGNOS suitability to rail specifications

As already mentioned, EGNOS is capable of providing ranging and correction data for accuracy enhancement but also integrity data, i.e. data to estimate the residual errors that can be expected by the users after having applied the corrections. These last data are the User Differential Range Error (UDRE) and the Grid Ionospheric Vertical Error (GIVE), commonly called ‘sigmas’ [58].

These two parameters can be used to determine an aggregate error, i.e. a bounded estimation of the horizontal and vertical position error that serves to compute the Protection Level (PL).

EGNOS is obviously used in most of the projects, as the service is open and free. However, the EGNOS Precision Approach (PA) and Non-precision Approach (NPA) navigation modes for civil aviation were designed according to specific aeronautical requirements (Filip 2010).

As described in [46], PA mode is very demanding in terms of SBAS data availability for example: PAs require that all satellites use SBAS corrections. NPA accepts that ionospheric corrections could be unavailable sometimes. NPA can also be used with longer degradation for fast corrections. This can cause larger error in HPE and HPL computation but one can propose to detect and manage it with diagnostics and multi sensor-based solutions. Thus [46] notices that “this navigation mode seems more acceptable for railway safety-related applications than the PA mode”. However, the conclusions says “The determination of the EGNOS dependability attributes in terms of failure modes, failure rates (on 1 hour basis), reliability and availability is needed for design, validation and certification of the land GNSS based safety-related systems”..

**4.3.2 EGNOS availability**

Due to the geostationary of the EGNOS satellites, its availability is not optimal along railway lines.

The tests performed in the LOCOPROL project, considering over 3000km of rail route in Italy, showed an overall measured availability of 66% for accuracy enhancement [45] and illustrated figure 15. EGNOS availability on other tracks has also been simulated in this project along the CFTA railway mountainous line between Nice and Digne in the south of France [38]. Because of the very quick changes of the environment around the antenna, EGNOS state of reception can vary very quickly also. Simulation results showed that 60% of the reception durations were shorter than 10 seconds and 40% shorter than 5 seconds that do not allow the receiver to benefit from integrity data. But some long areas of reception are observed. The longest one has a duration of 275 seconds, which allows the receiver to benefit of some corrections for accuracy gain.

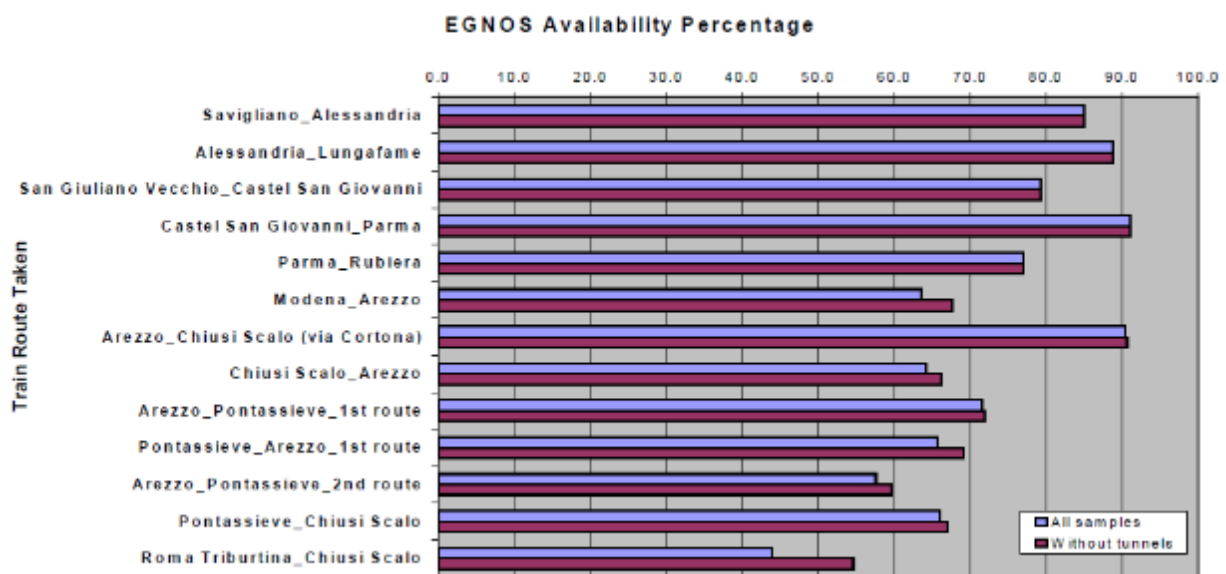

Figure 15: EGNOS availability along train routes in Italy, measured in the Locoprol project [45].

In RUNE, the EGNOS solutions along the line between Torino and Chivasso (and return) showed availability of around 45% of time (figure 16).

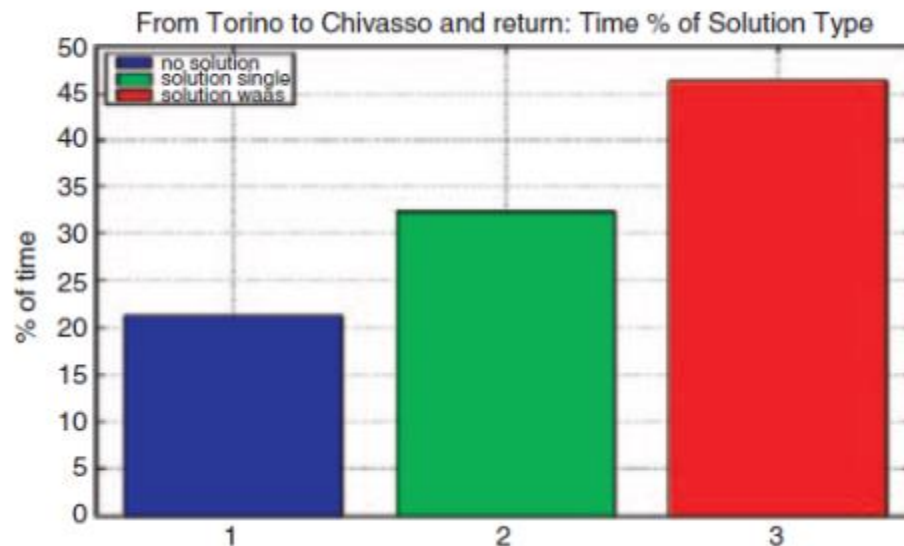

Figure 16: Distribution of the positioning mode measured along an Italian line in the RUNE project: no solution in blue, GNSS alone in green and GNSS/EGNOS in red [62].

Another example can be seen in [63]. Even if the application is road-related in this article, reception conditions can be very close from railway ones. The paper shows that EGNOS was received 84% of the time along the highway against around 10% in the urban context.

An alternative of the use of the EGNOS signal is the broadcast of the EGNOS information via terrestrial transmitters or via internet as proposed by the EDAS service. The availability of this alternative link is then to be verified.

Moreover, let's mention that the availability of the SBAS may be required only in concrete locations (e.g. at place and surrounding where the virtual balise is placed) and not along the entire railway line. The global availability of the SBAS can then be reduced along the line and the requirements be concentrated locally.

### 4.3.3 Classical pseudo-range error models versus real models

Today, only the aviation domain has defined specific service requirements for EGNOS use, as well as certification and individual authorization procedures. EGNOS 'sigmas' estimate the residual error boundaries after common mode error corrections but without local error estimation.

With EGNOS,  $\sigma_{UDRE}$  &  $\sigma_{GIVE}$  are the bases for HPL/VPL computation, under the assumption that pseudo-range errors follow normal centered laws and are independent. As illustrated in figure 17 with the observation of the pseudo-range error distribution of one satellite in time, one can notice that this assumption is not always verified, in particular in case of NLOS reception [44].

When based on ground-based infrastructure, residuals are estimated by the Ranging Integrity Monitoring Stations (RIMS), ground stations that do not take either into account local errors, which cannot be ignored in land transport applications.

Indeed, HPL computed by EGNOS makes the assumption that the local errors are bounded by the values defined in MOPS. These values have been established for airplane and are not at all representative of local environment of railway users. Such formulas that bound local error of railway applications indeed need to be established.

This work will be performed in the STARS H2020 European project (2016-2018).

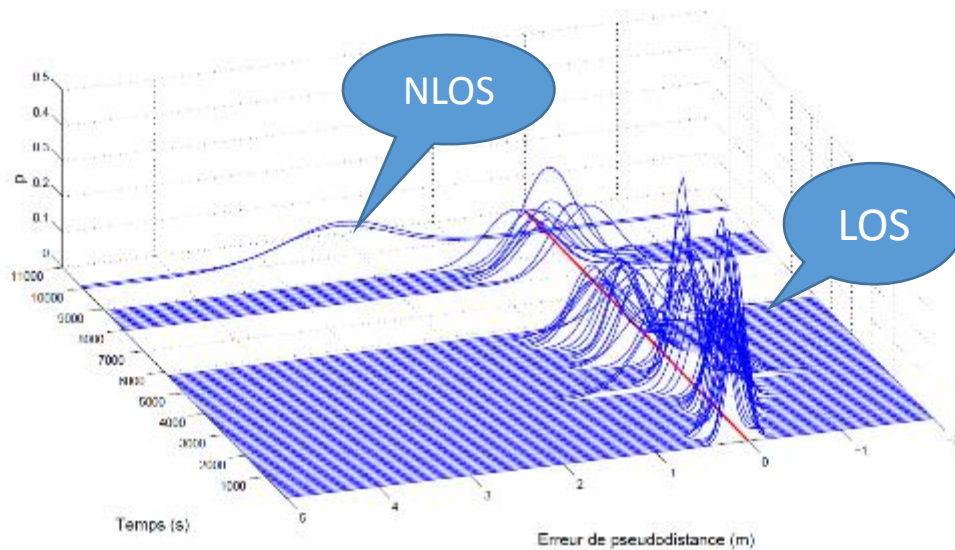

Figure 17: Pseudo-range error distribution versus time for LOS and NLOS received satellites [44].

#### 4.3.4 PL computation on the basis of LOS models

The receiver can statistically estimate the variance  $\sigma_i^2$  on the residual pseudo-range errors (the initial pseudo-range errors being corrected with EGNOS data) function of  $\sigma_{UDRE}^2$  and  $\sigma_{GIVE}^2$ . The variance related to the position errors according to the horizontal and vertical components ( $\sigma_{Hposition}^2$  and  $\sigma_{Vposition}^2$ ) is deduced from  $\sigma_i^2$  as indicated in equation 1. The terms of the equation are obtained from a least square residual algorithm in which it is admitted that the position error is a linear combination of the pseudo-range errors.

$$\sigma_{Xposition}^2 = \sum_{i=1}^N S_{X,i}^2 \cdot \sigma_i^2 \quad (1)$$

with  $X$  the horizontal or vertical component  
 $N$  number of pseudo-ranges used in the position estimation  
 $S_{X,i}^2$  is a parameter quantifying the geometrical impact of the satellites on the position, calculated on the basis of the same method than the dilution of precision GDOP.

Finally, the error distribution of the position follows a normal distribution  $N(0, \sigma_{Xposition})$  as it depends on the pseudo-range error combination that also follows a normal distribution. By inverting the cumulative density function of this distribution at the specified risk integrity probability

(i.e.  $cdf^{-1}(N)$  at the value of a specified missed probability  $P_{MD}$ ), PL can be obtained. For example,  $HPL = 6 \cdot \sigma_{Hposition}$  for an integrity risk of  $0.5 \cdot 10^{-9}$  for the horizontal component, and  $VPL = 5.33 \cdot \sigma_{Vposition}$  for an integrity risk of  $0.5 \cdot 10^{-7}$  on the vertical component.

VALUES OF PL OBTAINED IN THE PROJECTS

Based on classical SBAS-based HPL computation, the RUNE project experimented HPL in the order of 10m along a railway line as illustrated in figure 18.

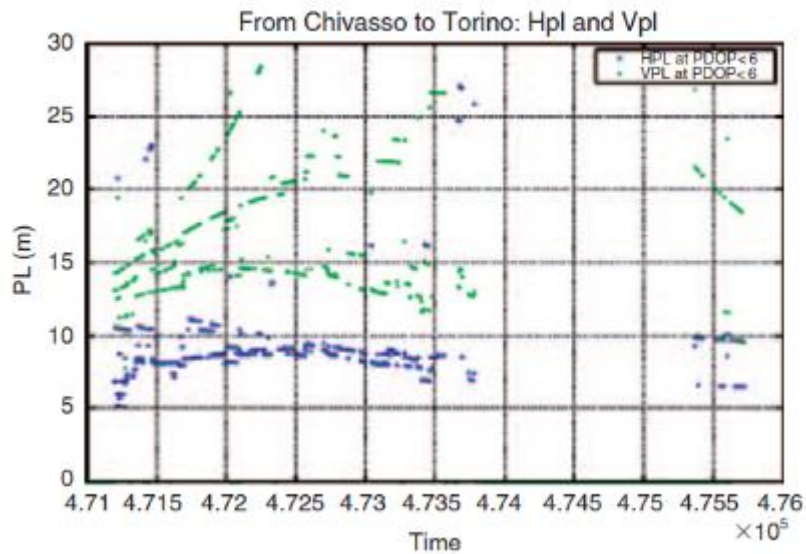

Figure 18: PL obtained in the RUNE project along a line considering that valid positions require that PDOP<6 [18].

In road domain, a HPL correctly bounding the errors ( $HPL < 8m$ ) has been measured by (Ali 2012) along highways but in the urban context, the authors illustrate that the receiver worked in safe operation mode only for 15% of the time.

In the 3inSat project, based on EGNOS and the AIMN presented above, PL also vary between 5 and 20m approximately, function of the AIMN availability as presented in figure 19.

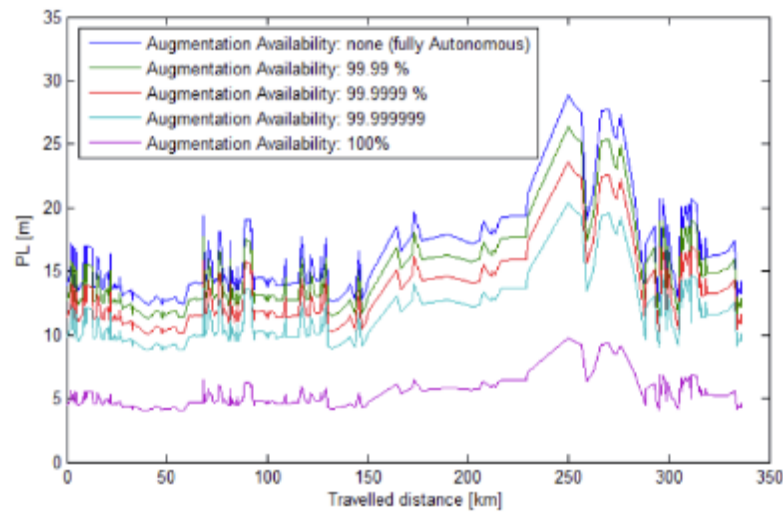

Figure 19: Roma-Pisa railway line. Protection level versus travelled distance with GPS constellation alone. PL is computed without augmentation system in blue (RAIM) and with the support of trackside augmentation systems for the other curves [10].

SUITABILITY OF THESE PL COMPARED TO TRUE POSITIONING ERROR?

In this section, we have shown that the past projects computed PL on the basis of EGNOS or GBAS information, i.e. on the basis of LOS error models. As expressed, the role of the PL is to bind the positioning error (PE) with a given probability. The PL shall define the smallest position error that must be detected with the required probabilities of false alert and missed detection.

The comparison of PL, PE and Alert Limit can be drawn with a Stanford diagram as represented in figure 20. For a safe use of the position, the system shall provide  $PE < PL < AL$ . As soon as PL is lower than PE, the system is failing. So can we see the importance of a correct estimation of the PL.

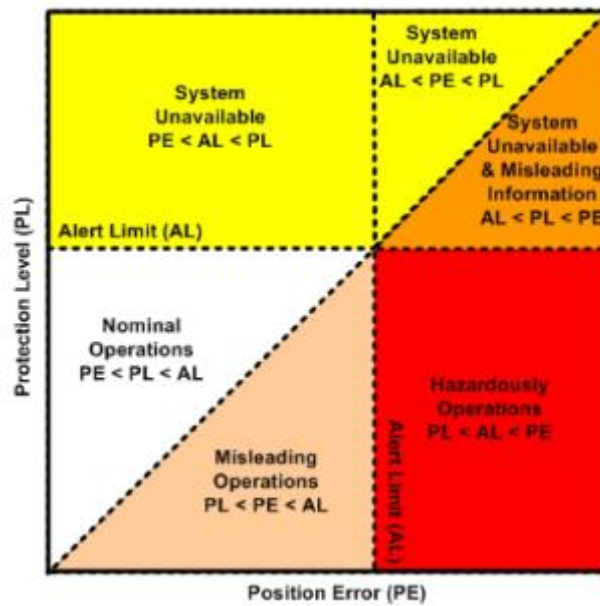

Figure 20: Stanford diagram

In the past projects, except in the 3inSat project and as far as we have seen, computed PL have not been compared to real PE in order to demonstrate the suitability of its computation in a railway environment. In 3inSat, the Augmented PVT performance has been assessed with respect to a Ground Truth developed by using an RTK Receiver installed on board and the RTK Networks available in the area of the demonstration [59] and has shown that the Phase 2 LDS System:

- does not provide a solution less than 2% of the epochs:
- is potentially intrusive (Protection Level > Application Threshold) less than 20% of the epochs
- is in MI/HMI less than 2% of the epochs.

### EGNOS TIME TO ALERT

Finally, let's mention the fact, that the EGNOS TTA is 6s, and can be sometimes problematic in the railway domain because some railway systems may require faster safe reaction than 6s.

### 5 CONCLUSIONS

This deliverable aims at drawing the state of the art of the EGNSS use in the railway signalling applications and in particular of the use of EGNOS.

After a presentation of the basics of GNSS augmentation systems, chapter 3 has drawn the panorama of the past projects. Each mentioned project has brought new elements for future integration of EGNSS in rail control/command signalling, especially in ETCS level 3. Different architectures have been proposed in order to fulfil the positioning requirements. GNSS drawbacks are compensated by the use of additional sensors that differ depending on the project: inertial sensors, telecommunication network... that help reaching the required accuracy and availability. EGNOS use in railway environments faces difficulties such as visibility or technical constraints. Thus some of the projects only used the GPS data, but when received, EGNOS shows its interest on accuracy and integrity.

Safety requires supplementary systems or algorithms. Chapter 3 presented embedded monitoring solutions and chapter 4 focused on the use of EGNOS for integrity monitoring. Past experiences have been described and results have been presented. Several issues for EGNOS have been identified:

- EGNOS visibility in constrained environment is not guaranteed. This is one of the reasons of ground-based augmentation solutions developed as a complementary system in Sardinia.
- EGNOS integrity monitoring concept has been developed for aeronautics and relies on the definition of phases of flight or modes. Such phases do not exist in railways.
- EGNOS integrity monitoring concept relies on the comparison of Protection Levels with Alert Limits. Alert Limits bounds tolerable errors around the estimated position that are not defined in railways specifications.
- Propagation conditions in a railway environment differ from the open-sky environment encountered by a plane. Thus EGNOS error model (computed for open sky environment) have to be compared to real error model in order to evaluate their suitability to the application context. Moreover, it will be interesting to evaluate the consistency of PL values regarding the true errors in order to quantify the capacity of EGNOS to properly bound the rail positioning errors.

This deliverable is the first task of the STARS WP5. The open issues presented in this document deserve to be discussed in the following tasks/activities of the project.



## 6 ANNEX

Name of the project	Period	Fundings
<b>APOLO</b>	1999-2001	
<b>GADEROS</b>	2001-2004	FP5
<b>INTEGRAIL</b>	2001-2004	
<b>LOCOPROL</b>	2001-2004	FP5
<b>GIRASOLE</b>	2005-2007	FP6
<b>ECORAIL</b>	2001-2005	ESA
<b>RUNE</b>	-2006	ESA
<b>LOCASYS</b>	2006-2009	UK sponsors (RSSB?)
<b>3inSat</b>	In progress	ESA
<b>NGTC</b>	In progress	FP7
<b>ERSAT</b>	In progress	ESA
<b>GRAIL</b>	2005-2007	FP6
<b>GRAIL2</b>	2010-2013	FP7
<b>EATS</b>	2012-2016	FP7
<b>SATLOC</b>	2012-2014	FP7
<b>GALOROI</b>	2012-2014	FP7
<b>IRISS</b>	2012-2014	ESA
<b>SafeRail</b>	In progress	ESA
<b>STARS</b>	2016-2018	H2020
<b>Rhinos</b>	In progress	H2020

## 7 REFERENCES

- [1] STARS Grant Agreement, Annex I - "Innovation Action", 25<sup>th</sup> of November 2015.
- [2] STARS Consortium Agreement of 6<sup>th</sup> November 2015.
- [3] Hosse, R. S., Manz, H., Burmeister, K., & Schnieder, E. (2014, April). Market analysis for satellite train localisation for train control systems. In Transport Research Arena (TRA) 5th Conference: Transport Solutions from Research to Deployment.
- [4] Neri, A., Rispoli, F., & Salvatori, P. (2015). An analytical assessment of a GNSS-based train integrity solution in typical ERTMS level 3 scenarios. In Proceedings of ENC 2015.
- [5] Rispoli, F., Neri, A., & Senesi, F. (2014). Innovative train control systems based on ERTMS and satellite-public TLC networks. Computers in Railways XIV: Railway Engineering Design and Optimization, 135, 51.
- [6] Manz, H., Schnieder, E., Becker, U., Seedorff, C., & Baudis, A. (2014, April). Approach to Certification of Satellite Based Localisation Unit in Railways. In Transport Research Arena (TRA) 5th Conference: Transport Solutions from Research to Deployment.
- [7] Urech, A., Pérez Diestro, J., & Gonzalez, O. (2002, July). GADEROS, a GALILEO Demonstrator for Railway Operation System. In Data Systems in Aerospace (Vol. 509, p. 46).
- [8] Mertens, P., & Franckart, J. P. (2003). Low-cost signalling on Low density lines. Railway Gazette International.
- [9] Raymond, G., Marais, J., Berbineau, M. (2004) Innovations Bring Satellite Control within Reach, Railway Gazette International, Déc. 2004, p835-837.
- [10] Neri, A., Filip, A., Rispoli, F., & Vegni, A. M. (2012). An analytical evaluation for hazardous failure rate in a satellite-based train positioning system with reference to the ERTMS train control systems. In 25th International Technical Meeting of The Satellite Division of the Institute of Navigation (ION GNSS 2012) (pp. 2770-2784). The Institute of Navigation.
- [11] Marais, J., Berbineau, M., Frimat, O., & Franckart, J. P. (2003, December). A new satellite-based fail-safe train control and command for low density railway lines. In TILT Seminar (Technological Innovations for Land Transportation), Lille, France.
- [12] Filip, A., Bažant, L., Mocek, H., Taufer, J., & Maixner, V. (2001). Architecture of GNSS aided signalling: Analysis and experiments. In Proceedings of World Congress on Railway Research (WCRR).
- [13] Böhringer, F., & Geistler, A. (2006, September). Comparison between different fusion approaches for train-borne location systems. In Multisensor Fusion and Integration for Intelligent Systems, 2006 IEEE International Conference on (pp. 267-272).

- [14] Hensel, S., Hasberg, C., & Stiller, C. (2011). Probabilistic rail vehicle localization with eddy current sensors in topological maps. In *Intelligent Transportation Systems*, IEEE Transactions on, 12(4), 1525-1536.
- [15] Gao, S. S., Sang, C. M., & Li, W. (2009). Application of improved particle filter to integrated train positioning system [J]. *Journal of Chinese Inertial Technology*, 6, 018.
- [16] Gerlach, K., & Hörste, M. M. Z. (2009, October). A precise digital map for GALILEO-based train positioning systems. In *Intelligent Transport Systems Telecommunications,(ITST), 2009 9th International Conference on* (pp. 343-347).
- [17] Manz, H., Schnieder, E., Stein, D., Spindler, M., Lauer, M., Seedorff, C., Baudis, A., Becker, U., Beugin, J., Nguyen, T.P. K., Marais, J., (2015). GaLoROI: Satellite based localization in railways, In *International congress on advanced railway engineering*, Istanbul, March 2-5 2015
- [18] Marradi, L., Albanese, A., & Di Raimondo, S. (2008). RENE (Railway User Navigation Equipment): Architecture & Tests. In *Satellite Communications and Navigation Systems* (pp. 461-479). Springer US.
- [19] Zheng, Y., & Cross, P. (2012). Integrated GNSS with different accuracy of track database for safety-critical railway control systems. *GPS solutions*, 16(2), 169-179.
- [20] Zheng, Y., Hutchinson, M., Lowe, D., Arrizabalaga, S., Goya, J., Zamora-Cadenas, L., Valera, J., Sanchez J. (2016). The hybrid GNSS/WCT multi-coach multi-constellation train positioning and integrity system. In *Proceedings of the 2016 International Technical Meeting, ION ITM 2016, January 25-28 Monterey, California*.
- [21] Lüddecke, K., & Rahmig, C. (2011, June). Evaluating multiple GNSS data in a multi-hypothesis based map-matching algorithm for train positioning. In *Intelligent Vehicles Symposium (IV), 2011 IEEE* (pp. 1037-1042).
- [22] Acharya, A., Sadhu, S., & Ghoshal, T. K. (2011). Train localization and parting detection using data fusion. In *Transportation Research Part C: Emerging Technologies*, 19(1), 75-84.
- [23] Wang, J., Yan, X. H., Cai, B. G., & Shangguan, W. (2011, November). Research on deeply integrated GPS/INS for autonomous train positioning. In *Proceedings of IEEE 4th International Symposium on Microwave, Antenna, Propagation, and EMC Technologies for Wireless Communications 2011* (pp. 687-690).
- [24] Saab, S. S. (2000). A map matching approach for train positioning. I. Development and analysis. In *Vehicular Technology*, IEEE Transactions on, 49(2), 467-475.
- [25] Liu, J., Cai, B. G., & Wang, J. (2014, October). A GNSS/trackmap cooperative train positioning method for satellite-based train control. In *Intelligent Transportation Systems (ITSC), 2014 IEEE 17<sup>th</sup> International Conference on* (pp. 2718-2724).

- [26] Albrecht, T., Luddecke, K., & Zimmermann, J. (2013, August). A precise and reliable train positioning system and its use for automation of train operation. In Intelligent Rail Transportation (ICIRT), 2013 IEEE International Conference on (pp. 134-139).
- [27] Böhringer, F., & Geistler, A. (2006). Location in railway traffic: Generation of a digital map for secure applications. In Computers in Railways X. The Tenth International Conference.
- [28] Neri, A., Palma, V., Rispoli, F., & Vegni, A. M. (2013, September). Track constrained PVT estimation based on the double-difference technique for railway applications. In Proceedings of the 21st European Signal Processing Conference (EUSIPCO), 2013 (pp. 1-5).
- [29] Heirich, O., Robertson, P., García, A. C., Strang, T., & Lehner, A. (2012, June). Probabilistic localization method for trains. In Intelligent Vehicles Symposium (IV), 2012 IEEE (pp. 482-487).
- [30] Kaplan, E., & Hegarty, C. (2006). Understanding GPS: Principles and Applications Second Edition.
- [31] Marradi, L., Galimberti, A., Foglia, L., Zin, A., Pecchioni, C., Doronzo, M. & Lekchiri, M. (2012, December). GNSS for Enhanced Odometry: The GRAIL-2 results. In Satellite Navigation Technologies and European Workshop on GNSS Signals and Signal Processing,(NAVITEC), 2012 6th ESA Workshop on (pp. 1-7).
- [32] Mirabadi, A., Mort, N., & Schmid, F. (1998, September). Fault detection and isolation in multisensor train navigation systems. In Control'98. UKACC International Conference on (Conf. Publ. No. 455) (pp. 969- 974).
- [33] Mirabadi, A., Schmid, F., & Mort, N. (2003). Multisensor integration methods in the development of a fault-tolerant train navigation system. The Journal of Navigation, 56(03), 385-398.
- [34] Nikiforov, I. V., Choquette, F., & Belgium, A. T. (2003, April). Integrity Equations for Safe Train Positioning Using GNSS. In Proceedings of GNSS 2003—The European Navigation Conference.
- [35] Jiang, L., Bai-Gen, C., Tao, T., & Jian, W. (2010, August). A CKF based GNSS/INS train integrated positioning method. In Mechatronics and Automation (ICMA), 2010 International Conference on (pp. 1686- 1689).
- [36] Jonas, M. (2014, May). Integrity enhancement of the GNSS position solution for the railway applications. In Position, Location and Navigation Symposium-PLANS 2014, 2014 IEEE/ION (pp. 839-845).
- [37] Marais, J., Meunier, B., & Berbineau, M. (2000). Evaluation of GPS availability for train positioning along a railway line. In Vehicular Technology Conference, 2000. IEEE-VTS Fall VTC 2000. 52nd (Vol. 5, pp. 2060-2067).

- [38] Marais, J., Flancquart, A., & Lefebvre, S. (2006). Satellite availability in a railway mountainous environment: Can we use satellite positioning for safety applications? In World Congress on Railway Research (WCRR), Montréal.
- [39] Marais, J., Girard, P. L., Prestail, A., Franchineau, J. L., & De Verdalle, E. (2007, June). Galileo availability for urban buses. In Telecommunications, 2007. ITST'07. 7th International Conference on ITS (pp. 1-5).
- [40] Marais, J., Tay, S., Flancquart, A., Meurie, C. (2015). Weighting with the pre-knowledge of GNSS signal state of reception in urban areas, In Proceedings of ENC GNSS 2015, 9 avril 2015, Bordeaux.
- [41] Liu, J., Gai, B., Wang, J., Shangguan, W. (2015) Estimating the Integrity of BDS-based Positioning for Rail Vehicles in Signaling Applications. In proceedings of CERGAL, Darmstadt, Germany.
- [42] GPS Standard Positioning Service Performance Standard – 30th September 2008 4th Edition
- [43] Salvatori, P., Neri, A., Stallo, C., Palma, V., Coluccia, A., & Rispoli, F. (2014, September). Augmentation and Integrity Monitoring Network and EGNOS performance comparison for train positioning. In Proceedings of the 22nd European Signal Processing Conference (EUSIPCO), 2014 (pp. 186-190).
- [44] Viandier, N., (2011), Modélisation et Utilisation des erreurs de pseudo-distances GNSS en environnement transport pour l'amélioration des performances de localisation, PhD Ecole Centrale de Lille.
- [45] Bortolotto, M., Choquette, F. (2003). EGNOS trials on Italian high-speed tilting trains. In proceedings of the GNSS 2003 conference, Graz, Austria.
- [46] Filip, A., Bažant, L., & Mocek, H. (2010). The experimental evaluation of the EGNOS safety-of-life services for railway signalling. WIT Transactions on The Built Environment, 114.
- [47] GIRASOLE, Galileo Safety of Life Receivers Development. Receiver Specification for Railway Applications. D2.1. Dec. 2005
- [48] EGNOS OS (Open Service) SDD (Service Definition Document) (2015). Issue 2.2
- [49] GRAIL (2007). Demonstration definition and Test Plan, WP4\_D4.1.1, 165p.
- [50] GRAIL (2008). Common Evaluation and Acceptance Level of Demonstration Results, WP4\_D4.1.2, 55p.
- [51] GRAIL (2006). Safety applications and the Requirements Background, WP2\_D2.1.1.
- [52] GRAIL (2007). EGNOS failures study. T511 technical Report, Annex D, WP3.4, 9p.
- [53] GALoROI (2012). Specification of localization unit, WP1\_D1.2.

- [54] GaLoROI (2014). RAMS parameter analysis. WP6\_D6.1\_v1.5, 52p.
- [55] GaLoROI (2014). Report on safety case including verification and validation report, WP6\_D6.2.
- [56] RHINOS (2016). Scenarios and requirements, D2.3 – SRD Part 1
- [57] Gurník, P. (2016). Next Generation Train Control (NGTC): More Effective Railways through the Convergence of Main-line and Urban Train Control Systems. *Transportation Research Procedia*, 14, 1855-1864.
- [58] EGNOS Safety of Life (SoL) Service Definition Document (2016). Revision 3.1.
- [59] 3inSat (2016). Final Report of the ESA Artes IAP 3inSat project,
- [60] Satloc (2014). Final publishable report D1.1 Part 1.
- [61] Locoprol (2005). Final deliverable.
- [62] Albanese, A., Marradi, L., Campa, L., & Orsola, B. (2004). The RUNE project: navigation performance of GNSS-based railway user navigation equipment. In *Proceedings of NAVITEC*.
- [63] Ali, K., Pini, M., & Dosis, F. (2012). Measured performance of the application of EGNOS in the road traffic sector. *GPS solutions*, 16(2), 135-145.
- [64] Liu, J., Tang, T., Gai, B., Wang, J., & Chen, D. (2011). Integrity assurance of GNSS-based train integrated positioning system. *Science China Technological Sciences*, 54(7), 1779-1792
- [65] Yamamoto, H., Takasu, T., & Kubo, N. (2015). Satellite Based Train Positioning Using Three-dimensional Track Maps. *Quarterly Report of RTRI*, 56(3), 194-199.