



HAL
open science

Trees of self-avoiding walks

Vincent Beffara, Cong Bang Huynh

► **To cite this version:**

| Vincent Beffara, Cong Bang Huynh. Trees of self-avoiding walks. 2018. hal-01635173v2

HAL Id: hal-01635173

<https://hal.science/hal-01635173v2>

Preprint submitted on 27 Nov 2018 (v2), last revised 23 Dec 2019 (v3)

HAL is a multi-disciplinary open access archive for the deposit and dissemination of scientific research documents, whether they are published or not. The documents may come from teaching and research institutions in France or abroad, or from public or private research centers.

L'archive ouverte pluridisciplinaire **HAL**, est destinée au dépôt et à la diffusion de documents scientifiques de niveau recherche, publiés ou non, émanant des établissements d'enseignement et de recherche français ou étrangers, des laboratoires publics ou privés.

TREES OF SELF-AVOIDING WALKS

VINCENT BEFFARA AND CONG BANG HUYNH

ABSTRACT. We consider the biased random walk on a tree constructed from the set of finite self-avoiding walks on a lattice, and use it to construct probability measures on infinite self-avoiding walks. The limit measure (if it exists) obtained when the bias converges to its critical value is conjectured to coincide with the weak limit of the uniform SAW. Along the way, we obtain a criterion for the continuity of the escape probability of a biased random walk on a tree as a function of the bias, and show that the collection of escape probability functions for spherically symmetric trees of bounded degree is stable under uniform convergence.

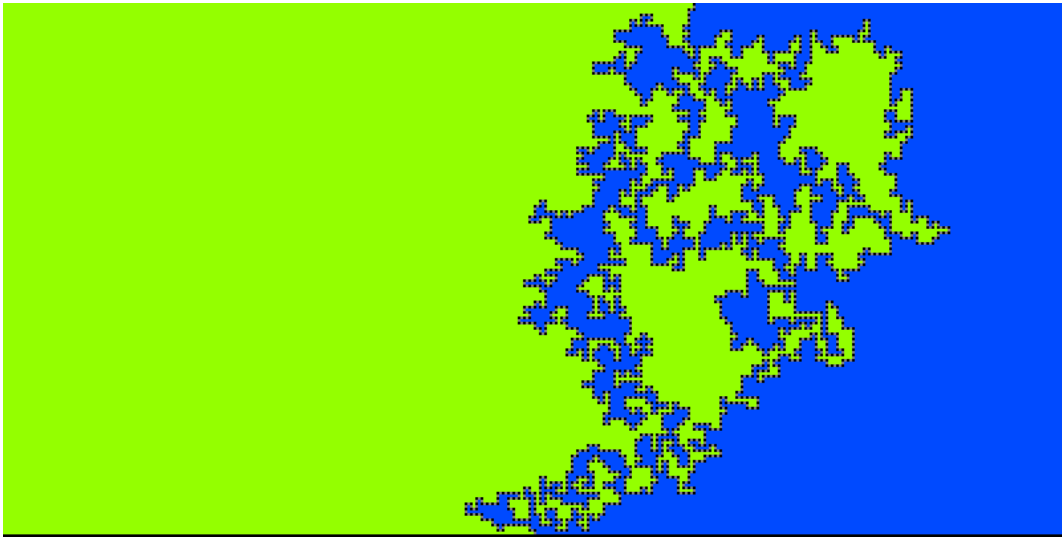

A realization of the limit walk in the upper-half plane, with bias $\lambda = 1$.

Key words and phrases. Self-avoiding walk, effective conductance, random walk on tree.

1. INTRODUCTION

An n -step self-avoiding walk (SAW) (or a self-avoiding walk of length n) in a regular lattice \mathbb{L} (such as the integer lattice \mathbb{Z}^2 , triangular lattice \mathbb{T} , hexagonal lattice, etc) is a nearest neighbor path $\gamma = (\gamma_0, \gamma_1, \dots, \gamma_n)$ that visits no vertex more than once. Self-avoiding walks were first introduced as a lattice model for polymer chains (see [5]); while they are very easy to define, they are extremely difficult to analyze rigorously and there are still many basic open questions about them (see [16], Chapter 1).

Let c_n be the number of SAWs of length n starting at the origin. The *connective constant* of \mathbb{L} , which we will denote by μ , is defined by

$$c_n = \mu^{n+o(n)} \quad \text{when } n \rightarrow \infty.$$

The existence of the connective constant is easy to establish from the submultiplicativity relation $c_{n+m} \leq c_n c_m$, from which one can also deduce that $c_n \geq \mu^n$ for all n ; the existence of μ was first observed by Hammersley and Morton [7]. Nienhuis [18] gave a prediction that for all regular planar lattices, $c_n = \mu^n n^{\alpha+o(1)}$ where $\alpha = \frac{11}{32}$, and this prediction is known to hold under the assumption of the existence of a conformally invariant scaling limit, see *e.g.* [13].

We are interested in defining a natural probability measure on the set SAW_∞ of *infinite* self-avoiding walks (*i.e.*, nearest-neighbors paths $(\gamma_k)_{k \geq 0}$ visiting no vertex more than once, see the sections 5.2 and 6). Such a measure was constructed before in the half-plane case as the weak limit of the uniform measures on finite self-avoiding walks, relying on results by Kesten (see [16, 10]), and it is part of our goal to investigate whether that measure and our construction are related.

1.1. The model. In this paper, we consider a one-parameter family of probability measures on SAW_∞ , denoted by $(\mathbb{P}_\lambda)_{\lambda > \lambda_c}$, defined informally as follows (see Notation 44 for a formal definition). Let $\mathcal{T}_{\mathbb{Z}^2}$ be the tree whose vertices are the finite self-avoiding walks in the plane starting at the origin, where two such vertices are adjacent when one walk is a one-step extension of the other. We will call this tree the *self-avoiding tree* on \mathbb{Z}^2 . Denoting by \mathbb{H} the upper-half plane in \mathbb{Z}^2 and by \mathbb{Q} the first quadrant, one can define the self-avoiding trees $\mathcal{T}_{\mathbb{H}}$ and $\mathcal{T}_{\mathbb{Q}}$ accordingly, and all the constructions below can be extended to these cases in a natural fashion which we will not make explicit in this introduction.

Then, consider the continuous-time biased random walk of parameter $\lambda > 0$ on $\mathcal{T}_{\mathbb{Z}^2}$, which from a given location jumps towards the root with rate 1 and towards each of its children vertices with rate λ . If λ is such that the walk is transient, its path determines an infinite branch in $\mathcal{T}_{\mathbb{Z}^2}$ which can be seen as a random infinite self-avoiding walk ω_λ^∞ ; we will denote by $\mathbb{P}_\lambda^{\mathbb{Z}^2}$ the law of ω_λ^∞ ,

omitting the mention of \mathbb{Z}^2 in the notation when it is clear from the context, and call it the *limit walk* with parameter λ .

The idea of seeing the self-avoiding walk as a dynamical object is very natural, and not new; it seems that the biased walk on the “self-avoiding tree” was first considered, mostly for $\lambda < \lambda_c$, by Berretti and Sokal ([2], see also [20, 19]) as a Monte-Carlo method to estimate connective constants and sample finite-size self-avoiding paths uniformly. The model was discussed informally by one of the authors of the present paper (VB) with S. Sidoravicius and W. Werner a number of years ago, as a failed attempt to understand conformal invariance of the SAW model in the scaling limit, and in particular a proof of Theorem 1 was obtained at that time but never written down; one of our informal goals here is to revive this line of thought: even though the question of SAW proper still seems out of reach, the link with critical percolation (cf. Section 6.2) could be a promising direction for further research.

1.2. Main results. It is well-known that there exists a critical value $\lambda_c = \lambda_c(\mathcal{T}_{\mathbb{Z}^2})$ such that if $\lambda > \lambda_c$ the biased random walk is transient and if $\lambda < \lambda_c$ it is recurrent (see Lyons [14]). In the general case of biased random walk on a tree, the recurrence or transience of the random walk at the critical point depends in subtle ways on the structure of the tree. The value of λ_c on the other hand is easier to determine: indeed, Lyons [14] proved that it coincides with the reciprocal of the branching number of the tree (for background on branching numbers and trees in general, see *e.g.* [15]). The following proposition gives the critical value for self-avoiding trees.

Theorem 1. *Let $\mathcal{T}_{\mathbb{Z}^2}, \mathcal{T}_{\mathbb{H}}, \mathcal{T}_{\mathbb{Q}}$ be the self-avoiding trees defined as above, respectively in the plan, half-plane and first quadrant. Then,*

$$\lambda_c(\mathcal{T}_{\mathbb{Z}^2}) = \lambda_c(\mathcal{T}_{\mathbb{H}}) = \lambda_c(\mathcal{T}_{\mathbb{Q}}) = \frac{1}{\mu},$$

where μ is the connective constant of lattice \mathbb{Z}^2 as defined above.

This is a direct consequence of Proposition 47 below. Notice that it is clear from the definition that μ is the growth rate of $\mathcal{T}_{\mathbb{Z}^2}$; there are rather large classes of trees, including $\mathcal{T}_{\mathbb{Z}^2}$, for which the branching and growth coincide (for instance, this holds for sub- or super-periodic trees, cf. below, or for typical supercritical Galton-Watson trees), but none of the classical results seem to apply to $\mathcal{T}_{\mathbb{H}}$ or $\mathcal{T}_{\mathbb{Q}}$.

The geometry of the limit walk is our main object of interest. As a first property of it, we obtain the following (see section 6.3):

Theorem 2. *For all $\lambda > \lambda_c$, under the measures $\mathbb{P}_{\lambda}^{\mathbb{Z}^2}$ and $\mathbb{P}_{\lambda}^{\mathbb{H}}$, the limit walk almost surely visits the line $\mathbb{Z} \times \{0\}$ infinitely many times.*

A useful tool in our proofs is the *effective conductance* of the biased random walk on a tree \mathcal{T} , defined as the probability of never returning to the root o of \mathcal{T} and denoted by $\mathcal{C}(\lambda, \mathcal{T})$ — see [15]. Along the way, we will be interested in several properties of it as a function of λ . Most important for us will be the question of continuity: in a general tree, the effective conductance is not necessarily a continuous function of λ . We will derive criteria for continuity, which are forms of *uniform transience* of the random walk, and apply them to prove that the effective conductance of self-avoiding trees is a continuous function (see Section 5.4):

Theorem 3. *The effective conductances $\mathcal{C}(\lambda, \mathcal{T}_{\mathbb{Q}})$, $\mathcal{C}(\lambda, \mathcal{T}_{\mathbb{H}})$ and $\mathcal{C}(\lambda, \mathcal{T}_{\mathbb{Z}^2})$ are continuous functions of λ on the interval $(\lambda_c, +\infty)$.*

A related question is that of the convergence of effective conductance along a sequence of trees. More precisely, let $(\mathcal{C}_n)_n$ denote the effective conductances for a sequence (\mathcal{T}_n) of infinite trees, again seen as functions of the bias parameter λ , and assume that $(\mathcal{C}_n)_n$ converges uniformly towards a function \mathcal{C} that is not identically 0. The question is: is \mathcal{C} the effective conductance of a certain tree? We study this question on the class of spherically symmetric trees (a tree \mathcal{T} is said to be spherically symmetric if for every vertex ν , $\deg \nu$ depends only on $|\nu|$, where $|\nu|$ denote its distance from the root and $\deg \nu$ is its number of neighbors). If \mathbb{S} denotes the set of spherically symmetric trees and $m \in \mathbb{N}^*$ is fixed, define

$$A_m := \{\mathcal{T} \in \mathbb{S}; \forall \nu \in \mathcal{T}, \deg \nu \leq m\} \text{ and}$$

$$\mathbb{F}_m := \{f \in C^0([0, 1]) : \exists \mathcal{T} \in A_m, \forall \lambda > 0, \mathcal{C}(\lambda, \mathcal{T}) = f(\lambda)\}.$$

Then (see Section 4.2):

Theorem 4. *Let $(f_n)_n$ be a sequence of functions in \mathbb{F}_m . Assume that f_n converges uniformly towards $f \neq 0$. Then $f \in \mathbb{F}_m$.*

1.3. Open questions. One natural probability measure on the set of infinite self-avoiding walks is the limit of $\mathbb{P}_{\lambda}^{\mathbb{H}}$ as $\lambda \rightarrow \lambda_c$, assuming that this limit exists. We were not able to show convergence, but obtained partial results in this direction by restricting the set of allowed paths. Our conjecture is that the limit exists and has to do with Kesten's measure, *i.e.* the weak limit of uniform finite self-avoiding walks in the half-plane, in a way similar to the fact that the two definitions of the incipient infinite cluster for percolation (seen as a limit as $p \rightarrow p_c$ or as a limit of conditioned critical percolation) coincide, see [12].

This is motivated by a few observations. First, the model for $\lambda < \lambda_c$ gives rise to a recurrent random walk on $\mathcal{T}_{\mathbb{H}}$ for which the invariant measure μ_{λ} is rather explicit (by reversibility, the mass of a vertex ν is proportional to $\lambda^{|\nu|}$), in particular it depends only on the distance to the root, and on the other

hand it tends to be concentrated on longer and longer walks as $\lambda \uparrow \lambda_c$. This means that the initial segment of a walk distributed as the stationary measure can be seen as the initial segment of a uniform self-avoiding walk with random total length, and we get convergence to Kesten's measure as soon as we can show that for all ν , $\mu_\lambda(\{\nu\}) \rightarrow 0$ as $\lambda \uparrow \lambda_c$. On the other hand, the behavior of the biased walk in a fixed neighborhood of the origin changes very little when λ is close to λ_c , so for λ slightly larger than λ_c it seems reasonable to predict that the walk will spend a long time close to the origin, following an occupation measure close to $\mu_{\lambda_c^-}$, before escaping to infinity. Unfortunately we were unable to formalize this intuition.

Another observation is that convergence of the law of the limit walk holds within the class of paths for which the bridge decomposition involves only bridges of height less than some fixed bound $m > 0$. More precisely: for fixed m , the critical parameter is $\lambda_{c,m} \geq \lambda_c$, and the limit $\lambda \downarrow \lambda_{c,m}$ followed by $m \rightarrow \infty$ leads to Kesten's measure, while the limit $m \rightarrow \infty$ for fixed λ coincides with the limit walk on $\mathcal{T}_{\mathbb{H}}$ with parameter λ — see Theorem 66 for more detail. Exchanging the limits would lead to the claim. Unfortunately, it is not true that this can be done in the general setting of biased walks on trees, due to phenomena similar to those described in section 3, so it seems that a deeper understanding of the structure of $\mathcal{T}_{\mathbb{H}}$ would be necessary to conclude.

1.4. Organization of the paper. The paper is structured as follows. In Section 2, we review some basic definitions on graphs, trees, branching number and growth rate of a tree, as well as a few classical results about random walks on trees. Section 3 gathers some relevant examples and counter-examples exhibiting some similarities to the self-avoiding trees while being treatable explicitly. The criterion for the continuity of the effective conductance is given in Section 4. Then Section 5 provides some background on self-avoiding walks and the self-avoiding trees, and some properties of the limit walks are obtained in Section 6. Finally, we state a few conjectures and conditional results in Section 7.

2. NOTATION AND BASIC DEFINITIONS

2.1. Graphs and trees. In this section, we review some basic definitions; we refer the reader to the book [15] for a more developed treatment. A *graph* is a pair $\mathcal{G} = (V, E)$ where V is a set of *vertices* and E is a symmetric subset of $V \times V$ (i.e if $(\nu, \mu) \in E$ then $(\mu, \nu) \in E$), called the *edge set*, containing no element of the form (ν, ν) . If $(\nu, \mu) \in E$, then we call ν and μ *adjacent* or *neighbors* and we write $\nu \sim \mu$. For any vertex $\nu \in V$, denote by $\deg \nu$ its number of neighbors. A *path* in a graph is a sequence of vertices, any two consecutive of which are adjacent. A *self-avoiding path* is a path which does not pass through any vertex more than once. For any $(\nu, \mu) \in V \times V$, the distance

between ν and μ is the minimum number of edges among all paths joining ν and μ , denoted $d(\nu, \mu)$. A graph is *connected* if, for each pair $(\nu, \mu) \in V \times V$, there exist a path starting at ν and ending at μ . A connected graph with no cycles is called a *tree*. A *morphism* from a graph \mathcal{G}_1 to a graph \mathcal{G}_2 is a mapping ϕ from $V(\mathcal{G}_1)$ to $V(\mathcal{G}_2)$ such that the image of any edge of \mathcal{G}_1 is an edge of \mathcal{G}_2 . We will always consider trees to be *rooted* by the choice of a vertex o , called the *root*.

Let $\mathcal{T} = (V, E)$ be an infinite, locally finite, rooted tree with set of vertices V and set of edges E . Let o be the root of \mathcal{T} . For any vertex $\nu \in V \setminus \{o\}$, denote by ν^{-1} its *parent* (we also say that ν is a *child* of ν^{-1}), *i.e.* the neighbour of ν with shortest distance from o . For any $\nu \in V$, let $|\nu|$ be the number of edges in the unique self-avoiding path connecting ν to o and call $|\nu|$ the *generation* of ν . In particular, we have $|o| = 0$.

If a vertex has no child, it is called a *leaf*. For any edge $e \in E$ denote by e^- and e^+ its endpoints with $|e^+| = |e^-| + 1$, and define the generation of an edge as $|e| = |e^+|$. We define an order on $V(\mathcal{T})$ as follows: if $\nu, \mu \in V(\mathcal{T})$, we say that $\nu \leq \mu$ if the simple path joining o to μ passes through ν . For each $\nu \in V(\mathcal{T})$, we define the *sub-tree* of \mathcal{T} rooted at ν , denoted by \mathcal{T}^ν , where $V(\mathcal{T}^\nu) := \{\mu \in V(\mathcal{T}) : \nu \leq \mu\}$ and $E(\mathcal{T}^\nu) = E(\mathcal{T})|_{V(\mathcal{T}^\nu) \times V(\mathcal{T}^\nu)}$.

An infinite simple path starting at o is called a *ray*. The set of all rays, denoted by $\partial\mathcal{T}$, is called the *boundary* of \mathcal{T} . The set $\mathcal{T} \cup \partial\mathcal{T}$ can be equipped with a metric that makes it a compact space, see [15].

The remaining part of this paper, we consider only infinite, locally finite and rooted trees with the root o .

2.2. Branching and growth.

Definition 5. Let \mathcal{T} be an infinite, locally finite and rooted tree. A *E-cutset* (resp. *V-cutset*) in \mathcal{T} is a set π of edges (resp. vertices) such that, for any infinite self-avoiding path $(\nu_i)_{i \geq 0}$ started at the root, there exists a $i \geq 0$ such that $[\nu_{i-1}, \nu_i] \in \pi$ (resp. $\nu_i \in \pi$). In other words, a *E-cutset* (resp. *V-cutset*) is a set of edges (resp. vertices) separating the root from infinity. We use Π to denote the set of *E-cutsets*.

Definition 6. Let \mathcal{T} be an infinite, locally finite and rooted tree.

- The branching number of \mathcal{T} is defined by:

$$br(\mathcal{T}) = \sup \left\{ \lambda \geq 1 : \inf_{\pi \in \Pi} \sum_{e \in \pi} \lambda^{-|e|} > 0 \right\}$$

- We define also

$$\overline{gr}(\mathcal{T}) = \limsup |\mathcal{T}_n|^{1/n} \quad \text{and} \quad \underline{gr}(\mathcal{T}) = \liminf |\mathcal{T}_n|^{1/n}.$$

In the case $\overline{gr}(\mathcal{T}) = \underline{gr}(\mathcal{T})$, the growth rate of \mathcal{T} is defined by their common value and denoted by $gr(\mathcal{T})$.

Remark 7. It follows immediately from the definition of branching number that if \mathcal{T}' is a sub-tree of \mathcal{T} , then $br(\mathcal{T}') \leq br(\mathcal{T})$.

Proposition 8 ([15]). Let \mathcal{T} be a tree, then $br(\mathcal{T}) \leq \underline{gr}(\mathcal{T})$.

In general, the inequality in Proposition 8 may be strict: The 1–3 tree (see [15], page 4) is an example for which the branching number is 1 and the growth rate is 2. There are classes of trees however where branching and growth match.

Definition 9. The tree \mathcal{T} is said to be spherically symmetric if $\deg \nu$ depends only on $|\nu|$.

Theorem 10 ([15] page 83). For every spherically symmetric tree \mathcal{T} , $br(\mathcal{T}) = \underline{gr}(\mathcal{T})$.

Definition 11. Let $N \geq 0$: an infinite, locally finite and rooted tree \mathcal{T} with the root o , is said to be

- N -sub-periodic if for every $\nu \in V(\mathcal{T})$, there exists an injective morphism $f : \mathcal{T}^\nu \rightarrow \mathcal{T}^{f(\nu)}$ with $|f(\nu)| \leq N$.
- N -super-periodic if for every $\nu \in V(\mathcal{T})$, there exists an injective morphism $f : \mathcal{T} \rightarrow \mathcal{T}^{f(o)}$ with $f(o) \in \mathcal{T}^\nu$ and $|f(o)| - |\nu| \leq N$.

Theorem 12 (see [6, 15]). Let \mathcal{T} be an infinite, locally finite and rooted tree that is either N -sub-periodic, or N -super-periodic with $\overline{gr}(\mathcal{T}) < \infty$. Then the growth rate of \mathcal{T} exists and $gr(\mathcal{T}) = br(\mathcal{T})$.

2.3. Random walks on trees. Let \mathcal{T} be a tree, we now define the discrete-time biased random walk on \mathcal{T} . Working in discrete time will make some of the arguments below a little simpler, at the cost of a slightly heavier definition here — notice though that the definition of the measure \mathbb{P}_λ and the main results of the paper are not at all affected by this choice.

Let $\lambda > 0$: the biased walk RW_λ with bias λ on \mathcal{T} is the discrete-time Markov chain on the vertex set of \mathcal{T} with transition probabilities given, at a vertex $x \neq o$ with k children, by

$$p_\lambda(x, y) := \begin{cases} \frac{1}{1+k\lambda} & \text{if } y \text{ is the father of } x, \\ \frac{\lambda}{1+k\lambda} & \text{if } y \text{ is a child of } x, \\ 0 & \text{otherwise.} \end{cases}$$

If the root has $k > 0$ children, then $p_\lambda(o, x)$ is $1/k$ if x is a child of o and 0 otherwise. The degenerate case $\mathcal{T} = \{o\}$ where the root has no child will not occur in our context, so we will silently ignore it. We also allow ourselves to

consider the cases $\lambda \in \{0, \infty\}$, with the natural convention that RW_0 remains stuck at the root and that RW_∞ always moves away from the root, getting stuck whenever it reaches a leaf.

Definition 13. Let $\mathcal{G} = (V, E)$ be a graph, and $c : E \rightarrow \mathbb{R}_+^*$ be labels on the edges, referred to as conductances. Equivalently, one can fix resistances by letting $r(e) := 1/c(e)$. The pair (\mathcal{G}, c) is called a network. Given a subset K of V , the restriction of c to the edges joining vertices in K defines the induced sub-network $\mathcal{G}|_K$. The random walk on the network (\mathcal{G}, c) is the discrete-time Markov chain on V with transition probabilities proportional to the conductances.

Given a network (\mathcal{T}, c) on a tree, let $\pi(o)$ be the sum of the conductances of the edges incident to the root, and denote by $T(o)$ the first return time to the origin by the walk. Following [15] (page 25), we can define the *effective conductance* of the network by

$$(2.1) \quad \mathcal{C}_c(\mathcal{T}) := \pi(o)\tilde{\mathcal{C}}_c(\mathcal{T}),$$

where $\tilde{\mathcal{C}}_c(\mathcal{T}) := \mathbb{P}[T(o) = +\infty]$. The reciprocal $\mathcal{R}_c(\mathcal{T})$ of the effective conductance is called the *effective resistance*.

The particular case where, on a tree \mathcal{T} , for an edge $e = (x, y)$ between a vertex x and any of its children y , $c(e)$ is chosen to be $\lambda^{|x|}$ will play a special role, because in that case the random walk on the network is exactly the same process as the random walk RW_λ defined earlier. In this setup, we will denote the effective conductance (resp. effective resistance) by $\mathcal{C}(\lambda, \mathcal{T})$ (resp. $\mathcal{R}(\lambda, \mathcal{T})$) to emphasize its dependency on the parameter λ . Let ν be a child of o , we write $\tilde{\mathcal{C}}(\lambda, \mathcal{T}, \nu)$ for the probability of the event that the random walk RW_λ on \mathcal{T} , started at the root (i.e. $X_0 = o$), never returns to it and reached ν at the first step (i.e. $X_1 = \nu$).

Theorem 14 (Rayleigh's monotonicity principle [15]). *Let \mathcal{T} be an infinite tree with two assignments, c and c' , of conductances on \mathcal{T} with $c \leq c'$ (everywhere). Then the effective conductances are ordered in the same way: $\mathcal{C}_c(\mathcal{T}) \leq \mathcal{C}_{c'}(\mathcal{T})$.*

Corollary 15. *Let $\mathcal{T}, \mathcal{T}'$ be two infinite trees; we say that $\mathcal{T} \subset \mathcal{T}'$ if there exists an injective morphism $f : \mathcal{T} \rightarrow \mathcal{T}'$. If this holds, then for every $\lambda > 0$, $\mathcal{C}(\lambda, \mathcal{T}') \leq \mathcal{C}(\lambda, \mathcal{T})$.*

In the case of spherically symmetric trees, the equivalent resistance is explicit:

Proposition 16 (see [15]). *Let \mathcal{T} be spherically symmetric and $(c(e))$ be conductances that are themselves constant on the levels of \mathcal{T} . Then $\mathcal{R}_c(\mathcal{T}) = \sum_{n \geq 1} \frac{1}{c_n |\mathcal{T}_n|}$, where c_n is the conductance of the edges going from level $n - 1$ to level n .*

The following corollaries are the consequences of Proposition 16:

Corollary 17. *Let \mathcal{T} be a spherically symmetric tree. The effective conductance $\mathcal{C}(\lambda, \mathcal{T})$ is a continuous function on $(\lambda_c, +\infty)$.*

Corollary 18. *Let \mathcal{T} be a spherically symmetric tree. Then RW_λ is transient if and only if $\sum_n \frac{1}{\lambda^n |\mathcal{T}_n|} < \infty$.*

Theorem 19 (Nash-Williams criterion, see [17]). *If $(\pi_n, n \geq 0)$ is a sequence of pairwise disjoint finite E -cutsets in a locally finite network \mathcal{G} , then*

$$\mathcal{R}_c(\mathcal{T}) \geq \sum_n \left(\sum_{e \in \pi_n} c(e) \right)^{-1}.$$

In particular, if $\sum_n (\sum_{e \in \pi_n} c(e))^{-1} = +\infty$, then the random walk associated to this family of conductances $(c(e), e \in E(\mathcal{T}))$ is recurrent.

We end this subsection by stating a classical theorem relating the recurrence or transience of RW_λ to the branching of the underlying tree:

Theorem 20 (see [14]). *Let \mathcal{T} be an infinite, locally finite and rooted tree. If $\lambda < \frac{1}{br(\mathcal{T})}$ then RW_λ is recurrent, whereas if $\lambda > \frac{1}{br(\mathcal{T})}$, then RW_λ is transient. The critical value of biased random walk on \mathcal{T} is therefore $\lambda_c(\mathcal{T}) := \frac{1}{br(\mathcal{T})}$.*

2.4. The law of the first k steps of the limit walk. Let \mathcal{T} be a tree and $(c(e))$ be conductances on the edges of \mathcal{T} such that the associated random walk (X_n) is transient. For every $k \geq 0$, the walk visits \mathcal{T}_k finitely many times: we can define an infinite path ω^∞ on \mathcal{T} by letting $\omega^\infty(k)$ be the last vertex of \mathcal{T}_k visited by the walk. Equivalently:

$$(2.2) \quad \omega^\infty(k) = \nu \iff \nu \in \mathcal{T}_k \text{ and } \exists n_0, \forall n > n_0 : X_n \in \mathcal{T}^\nu.$$

Let $k \in \mathbb{N}^*$ and $\nu_0 = o, \nu_1, \nu_2, \dots, \nu_k$ be k elements of $V(\mathcal{T})$ such that $(\nu_0, \nu_1, \nu_2, \dots, \nu_k)$ is a simple path: we can then define

$$(2.3) \quad \varphi_c(\nu_0, \nu_1, \nu_2, \dots, \nu_k) := \mathbb{P}(\omega^\infty(0) = \nu_0, \omega^\infty(1) = \nu_1, \dots, \omega^\infty(k) = \nu_k).$$

We will refer to this function as the *law of first k steps of limit walk*. In the case of the biased walk RW_λ , we will denote the function by $\varphi^{\lambda, k}$; this will not lead to ambiguities. We finish this section with the following lemma.

Lemma 21. *The value of $\varphi_c(\nu_0, \dots, \nu_k)$ depends continuously on any finite collection of the conductances in the network. More precisely, given a finite set $U = \{e_1, \dots, e_\ell\}$ of edges and a collection $(c(e))$ of conductances, let $\tilde{c}(u_1, \dots, u_\ell)$ be the family of conductances that coincides with c outside U and takes value u_i at e_i : then the map*

$$\psi_{U, c} : (u_1, \dots, u_\ell) \mapsto \varphi_{\tilde{c}(u_1, \dots, u_\ell)}(\nu_0, \dots, \nu_k)$$

is continuous on $(\mathbb{R}_+^*)^\ell$.

Proof. The proof is simple, therefore it is omitted. \square

3. A FEW EXAMPLES

The self-avoiding tree in the plane, which we alluded to in the introduction and will formally introduce in the next section, is sub-periodic but quite inhomogeneous, and the self-avoiding tree in the half-plane sits in none of the classes of trees defined above. To get an intuition of the kind of behavior we should expect or rule out, we gather here a few examples of trees with some atypical features.

3.1. Trees with discontinuous conductance. Let $0 < \lambda_0 \leq 1$. In the first part of this section, we construct two trees $\mathcal{T}, \bar{\mathcal{T}}$ with $\lambda_c(\mathcal{T}) = \lambda_c(\bar{\mathcal{T}}) = \lambda_0$, such that the effective conductances $C(\lambda, \mathcal{T})$ and $C(\lambda, \bar{\mathcal{T}})$ of the biased random walk RW_λ on \mathcal{T} and $\bar{\mathcal{T}}$ satisfy $\mathcal{C}(\lambda_c(\mathcal{T}), \mathcal{T}) = 0$ but $\mathcal{C}(\lambda_c(\bar{\mathcal{T}}), \bar{\mathcal{T}}) > 0$. In the second part, we construct a tree \mathcal{T} such that $C(\lambda, T)$ is not continuous on $(\lambda_c, 1)$.

Proposition 22. *For every $x \geq 1$, there exist two trees \mathcal{T} and $\bar{\mathcal{T}}$ such that:*

- $br(\mathcal{T}) = br(\bar{\mathcal{T}}) = x$;
- $RW_{1/x}$ is recurrent on \mathcal{T} and transient on $\bar{\mathcal{T}}$.

Proof. We will construct spherically symmetric trees satisfying both conditions. Denoting by $[y]$ be the integer part of y . We construct the sequence $(\ell_i)_{i \in \mathbb{N}^*}$ inductively as follows:

$$\ell_1 = [x], \quad \ell_2 = \left\lfloor \frac{x^2}{\ell_1} \right\rfloor, \quad \ell_3 = \left\lfloor \frac{x^3}{\ell_1 \ell_2} \right\rfloor, \quad \dots, \quad \ell_n = \left\lfloor \frac{x^n}{\prod_{i=1}^{n-1} \ell_i} \right\rfloor, \quad \dots$$

and let \mathcal{T} be the tree where vertices at distance i from o have ℓ_i children, so that the sizes of the levels of \mathcal{T} are given by $|\mathcal{T}_n| = \prod_{i=1}^n \ell_i$. We construct the tree $\bar{\mathcal{T}}$ from the degree sequence $(\ell'_i)_{i \in \mathbb{N}}$ by posing $\ell'_i = 2\ell_i$ if i can be written under the form $i = k^2$, and $\ell'_i = \ell_i$ otherwise. Notice that $|\bar{\mathcal{T}}_n| = 2^{\lfloor \sqrt{n} \rfloor} |\mathcal{T}_n|$.

We first show that both trees have branching number x . Since they are spherically symmetric, it is enough to check that their growth rate is x ; the case $x = 1$ is trivial, so assume $x > 1$. From the definition,

$$x^n - \prod_{i=1}^{n-1} \ell_i \leq \prod_{i=1}^n \ell_i \leq x^n \quad \text{hence} \quad x^n - x^{n-1} \leq |\mathcal{T}_n| \leq x^n$$

so $gr(\mathcal{T}) = x$; the case of $\bar{\mathcal{T}}$ follows directly.

The recurrence or transience of the critical random walks can be determined using lemma 18:

$$\sum \frac{1}{\lambda_c^n |\mathcal{T}_n|} \geq \sum \frac{1}{\lambda_c^n x^n} = +\infty$$

so the critical walk on $\mathcal{T}(x)$ is recurrent, while for $x > 1$,

$$\sum \frac{1}{\lambda_c^n |\overline{\mathcal{T}}_n|} \leq \sum \frac{1}{\lambda_c^n (x^n - x^{n-1}) 2^{\lfloor \sqrt{n} \rfloor}} = \frac{x}{x-1} \sum \frac{1}{2^{\lfloor \sqrt{n} \rfloor}} < \infty$$

so the critical walk on $\overline{\mathcal{T}}(x)$ is transient. In the case $x = 1$ one gets $\sum 2^{-\lfloor \sqrt{n} \rfloor} < \infty$ instead, and the conclusion is the same. \square

Proposition 23. *For every $k \in \mathbb{N}^*$ and $\lambda_c \in (0, 1)$, there exists a tree \mathcal{T} with critical drift $\lambda_c(\mathcal{T}) = \lambda_c$ such that the ratio $C(\lambda)/(\lambda - \lambda_c)^k$ remains bounded away from 0 as $\lambda \rightarrow \lambda_c^+$.*

Proof. We construct a spherically symmetric tree \mathcal{T} which satisfies the conditions of this proposition in a similar way as before. Letting $x = 1/\lambda_c > 1$, define inductively:

$$\ell_1 = \lfloor x \rfloor, \quad \ell_2 = \left\lfloor \frac{x^2}{2^k \ell_1} \right\rfloor, \quad \dots, \quad \ell_n = \left\lfloor \frac{x^n}{n^k \prod_{i=1}^{n-1} \ell_i} \right\rfloor, \quad \dots$$

Let T be the spherically symmetric tree with degree sequence (ℓ_i) . It is easy to check that $br(\mathcal{T}) = x$ like in the previous proposition; in a similar way,

$$x^n - n^k \prod_{i=1}^{n-1} \ell_i \leq n^k \prod_{i=1}^n \ell_i \leq x^n \quad \text{hence} \quad \frac{x^n}{n^k} - \frac{x^{n-1}}{(n-1)^k} \leq |\mathcal{T}_n| \leq \frac{x^n}{n^k}.$$

Recall that $x = 1/\lambda_c$ and by using Proposition 16, the effective resistance at parameter $\lambda > \lambda_c$ is given by

$$\mathcal{R}(\lambda, \mathcal{T}) = \sum \frac{1}{\lambda^n |\mathcal{T}_n|} \geq \sum \frac{n^k}{(\lambda x)^n} \sim \frac{C_k}{(\lambda - \lambda_c)^{k+1}}$$

with a lower bound of the same order but with a different constant, leading to the conclusion. \square

We end this subsection with the following proposition, showing that discontinuities can occur elsewhere than at λ_c :

Proposition 24. *There exists a tree \mathcal{T} such that the function $C(\lambda, \mathcal{T})$ is not continuous on $(\lambda_c, 1)$, i.e it will be discontinuous at a certain $\lambda' \in (\lambda_c, 1)$.*

Proof. Let $0 < \lambda_1 < \lambda_2 < 1$. By proposition 22, there exist two trees \mathcal{H} and \mathcal{G} such that $\lambda_c(\mathcal{H}) = \lambda_1, \lambda_c(\mathcal{G}) = \lambda_2$ and

$$(3.1) \quad \mathcal{C}(\lambda_1, \mathcal{H}) = 0, \quad \mathcal{C}(\lambda_2, \mathcal{G}) > 0.$$

We construct a tree \mathcal{T} rooted at o as follows:

$$\mathcal{T}_1 = \{\nu_1, \nu_2\}, \quad \mathcal{T}^{\nu_1} = \mathcal{H} \quad \text{and} \quad \mathcal{T}^{\nu_2} = \mathcal{G}.$$

Hence,

$$\lambda_c(\mathcal{T}) = \lambda_1.$$

Denote $\deg \nu_1$ (resp. $\deg \nu_2$) the degree of ν_1 (resp. ν_2) in the tree \mathcal{T} . By an easy computation, for any $\lambda \in (\lambda_1, 1)$, we obtain:

$$(3.2) \quad \mathcal{C}(\lambda, \mathcal{T}) = \frac{1}{2} \times \frac{\lambda \mathcal{C}(\lambda, \mathcal{H}) \deg \nu_1}{1 + \lambda \mathcal{C}(\lambda, \mathcal{H}) \deg \nu_1} + \frac{1}{2} \times \frac{\lambda \mathcal{C}(\lambda, \mathcal{G}) \deg \nu_2}{1 + \lambda \mathcal{C}(\lambda, \mathcal{G}) \deg \nu_2}.$$

By corollary 17, the function $\mathcal{C}(\lambda, \mathcal{H})$ is continuous on $(\lambda_1, 1)$ and since $\mathcal{C}(\lambda, \mathcal{G}) = 0$ for any $\lambda \in (\lambda_1, \lambda_2)$, therefore:

$$(3.3) \quad \lim_{\lambda \rightarrow \lambda_2^-} \mathcal{C}(\lambda, \mathcal{T}) = \frac{1}{2} \times \frac{\lambda_2 \mathcal{C}(\lambda_2, \mathcal{H}) \deg \nu_1}{1 + \lambda_2 \mathcal{C}(\lambda_2, \mathcal{H}) \deg \nu_1}.$$

By Equations 3.1, 3.2 and 3.3, we obtain:

$$\lim_{\lambda \rightarrow \lambda_2^-} \mathcal{C}(\lambda, \mathcal{T}) < \mathcal{C}(\lambda_2, \mathcal{T}).$$

The latter inequality implies that the function $\mathcal{C}(\lambda, \mathcal{T})$ is discontinuous at λ_2 . \square

Note that continuity properties at $\lambda \geq 1$ are actually easier to obtain, and we will investigate them further below.

3.2. The convergence of the law of the first k steps.

If $\lim_{\lambda \rightarrow \lambda_c, \lambda > \lambda_c} \mathcal{C}(\lambda, \mathcal{T}) > 0$, by Lemma 62 the limit of $\varphi^{\lambda, k}(y_1, \dots, y_k)$ when λ decreases to λ_c exists. If one has $\lim_{\lambda \downarrow \lambda_c} \mathcal{C}(\lambda, \mathcal{T}) = 0$, the situation is more delicate and we cannot yet conclude on the limit of the function $\varphi^{\lambda, k}(\nu_0, \dots, \nu_k)$ when λ decreases to λ_c . Indeed, convergence does not always hold, as we will see in a counterexample. The idea of what follows is easy to describe: we are going to construct a very inhomogeneous tree with various subtrees of higher and higher branching numbers, at locations alternating between two halves of the whole tree; a biased random walk will wander until it finds the first such sub-tree inside which it is transient, and escape to infinity within this subtree with high probability.

Proposition 25. *There exists a tree \mathcal{T} such that the function $\varphi^{\lambda, 1}(y_0, y_1)$ does not converge as $\lambda \rightarrow \lambda_c$.*

Notation 26. *Let $\mathcal{T}, \mathcal{T}'$ be two trees and $A \subset V(\mathcal{T})$. We can construct a new tree by grafting a copy of \mathcal{T}' at all the vertices of A ; we will denote this new tree by $\mathcal{T} \overset{A}{\oplus} \mathcal{T}'$. Note that for all $x \in A$, $(\mathcal{T} \overset{A}{\oplus} \mathcal{T}')^x \simeq \mathcal{T}'$. In the case $A = \{x\}$, we will use the simpler notation $\mathcal{T} \overset{x}{\oplus} \mathcal{T}'$ for $\mathcal{T} \overset{\{x\}}{\oplus} \mathcal{T}'$.*

Proof. Fix $\varepsilon > 0$ small enough. By Proposition 22, for all $0 < a \leq 1$, there exists a tree, denoted by $\mathcal{T}(a)$, such that its branching number is $\frac{1}{a}$ and $\mathcal{C}(a, \mathcal{T}(a)) = 0$. Let $\mathcal{H} = \mathbb{Z}$, seen as a tree rooted at 0, so that the integers is the vertices of \mathcal{H} (see the Figure 1). We are going to construct a tree inductively.

Let $(a_i)_{i \geq 1}$ be a decreasing sequence such that $a_1 < 1$. Denote $a_c := \lim a_i$ and assume that $a_c > 0$. Choose a sequence $(b_i)_{i \geq 1}$ such that $b_i \in (a_{i+1}, a_i)$ for all i . First, set $\mathcal{H}^0 := (\mathcal{H} \overset{-2}{\oplus} \mathcal{T}(a_1)) \overset{2}{\oplus} \mathcal{T}(a_2)$. We consider the biased random walk RW_{b_1} , then it is recurrent on $\mathcal{T}(a_1)$ and transient on $\mathcal{T}(a_2)$. On \mathcal{H}^0 , the biased random walk RW_{b_1} is transient, and in addition we know that it stays eventually within the copy of $\mathcal{T}(a_2)$. There exists then $N_1 > 2$ such that the probability that the limit walk remains in that copy after time $N_1 - 1$ is greater than $1 - \varepsilon$.

Then we set $\mathcal{H}^1 = (\mathcal{H}^0 \overset{-N_1}{\oplus} \mathcal{T}(a_3))$. On \mathcal{H}^1 , the walk of bias b_1 is still transient and still has probability at least $1 - \varepsilon$ to escape through the copy of $\mathcal{T}(a_2)$, because $\mathcal{T}(a_3)$ is grafted too far to be relevant. On the other hand, consider the biased random walk RW_{b_2} : it is still transient on \mathcal{H}^1 but only through the new copy of $\mathcal{T}(a_3)$. There exists then $N_2 > 2$ such that the probability that the limit walk remains in that copy after time $N_2 - 1$ is greater than $1 - \varepsilon$.

We can set $\mathcal{H}^2 := (\mathcal{H}^1 \overset{N_2}{\oplus} \mathcal{T}(a_4))$ and continue this procedure to graft all the trees $\mathcal{T}(a_i)$, further and further from the origin and alternatively on the left and on the right; we denote by \mathcal{H}^∞ the union of all the \mathcal{H}^k .

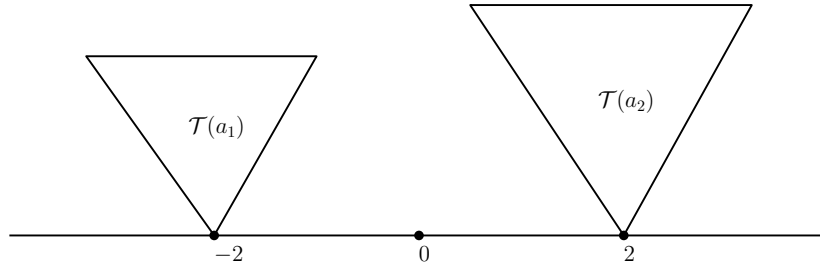

FIGURE 1. Tree \mathcal{H}^0

It remains to show that the function $\varphi^{\lambda,1}(0, 1)$ for the biased random walk on the tree \mathcal{H}^∞ does not converge. We have $br(\mathcal{H}^\infty) = \max_i br(\mathcal{T}(a_i)) = \frac{1}{a_c}$ and $\varphi^{b_i,1}(0, 1) \geq 1 - \varepsilon$ if i is odd while $\varphi^{b_i,1}(0, -1) \geq 1 - \varepsilon$ if i is even. Then,

$$\forall k \geq 0, \begin{cases} \varphi^{b_i,1}(0, 1) \geq 1 - \varepsilon & \text{if } i = 2k + 1 \\ \varphi^{b_i,1}(0, 1) \leq \varepsilon & \text{if } i = 2k + 2 \end{cases}$$

This implies that the function $\varphi^{\lambda,1}(0, 1)$ does not converge when λ go to a_c . \square

The tree we just constructed is tailored to be extremely inhomogeneous. At the other end of the spectrum, some trees have enough structure for all the functions we are considering to be essentially explicit:

Definition 27. A tree \mathcal{T} is called *periodic* (or *finite type*) if, for all $v \in V(\mathcal{T}) \setminus \{o\}$, there is a bijective morphism $f : \mathcal{T}^v \rightarrow \mathcal{T}^{f(v)}$ with $f(v)$ in a fixed, finite neighborhood of the root of \mathcal{T} .

Definition 28. Let \mathcal{T} be a finite tree and $\mathcal{L}(\mathcal{T})$ be the set of leafs of \mathcal{T} . We set $\mathcal{T}^1 = \mathcal{T} \bigoplus_{\mathcal{L}(\mathcal{T})} \mathcal{T}$, $\mathcal{T}^2 = \mathcal{T}^1 \bigoplus_{\mathcal{L}(\mathcal{T}^1)} \mathcal{T}$, \dots , $\mathcal{T}^n = \mathcal{T}^{n-1} \bigoplus_{\mathcal{L}(\mathcal{T}^{n-1})} \mathcal{T}$ for every $n \geq 2$. We continue this procedure an infinite number of times to obtain an infinite tree $\mathcal{T}^{\infty, \mathcal{T}}$. Note that $\mathcal{T}^{\infty, \mathcal{T}}$ is also a periodic tree.

Fact 29 (see Lyons [14], theorem 5.1). Let \mathcal{T} be a periodic tree and $(\nu_0 = o, \nu_1, \nu_2, \dots, \nu_k)$ be a simple path on \mathcal{T} . Then $\varphi^{\lambda, k}(\nu_0, \nu_1, \dots, \nu_k)$ converges when λ decreases to $\lambda_c(\mathcal{T})$.

In the rest of this section we provide a new proof of a particular case (the case of $\mathcal{T}^{\infty, \mathcal{T}}$) of fact 29:

Proposition 30. Let \mathcal{T} be a finite tree and $(\nu_0 = o, \nu_1, \nu_2, \dots, \nu_k)$ be a simple path on $\mathcal{T}^{\infty, \mathcal{T}}$. Then the function $\varphi^{\lambda, k}(\nu_0, \nu_1, \dots, \nu_k)$ of $\mathcal{T}^{\infty, \mathcal{T}}$ converges when λ decreases to $\lambda_c(\mathcal{T}^{\infty, \mathcal{T}})$.

Before showing the proposition 30, we need to show the following lemma:

Lemma 31. Let \mathcal{T} be a tree rooted at o such that $\deg o = d_0$ and

$$\left\{ \begin{array}{l} \mathcal{T}_1 = \{\nu_1, \nu_2, \dots, \nu_{d_0}\} \\ \forall i \in \{1, 2, \dots, d_0\}, \lambda_c(\mathcal{T}) = \lambda_c(\mathcal{T}^{\nu_i}) = \lambda_c \text{ and } \mathcal{C}(\lambda_c, \mathcal{T}) = \mathcal{C}(\lambda_c, \mathcal{T}^{\nu_i}) = 0 \end{array} \right.$$

Then for all i , we have $\tilde{\mathcal{C}}(\lambda, \mathcal{T}, \nu_i) = \frac{(d_{\nu_i}-1)\lambda\tilde{\mathcal{C}}(\lambda, \mathcal{T}^{\nu_i})}{d_0(1+(d_{\nu_i}-1)\lambda\tilde{\mathcal{C}}(\lambda, \mathcal{T}^{\nu_i}))}$, where $d_{\nu_i} = \deg \nu_i$.

Proof. Recall that $\tilde{\mathcal{C}}(\lambda, \mathcal{T}, \nu_i) = \mathbb{P}(\mathcal{A})$, where \mathcal{A} is the event that the random walk RW_λ on \mathcal{T} , started at the root (i.e $X_0 = o$), never returns to it and reached ν_i at the first step (i.e $X_1 = \nu_i$). We can write

$$\mathcal{A} = \bigcup_{k \geq 0} \mathcal{A}_k$$

where

$$\mathcal{A}_k := \{\#\{j > 0 : X_j = o\} = 0\} \cap \{X_1 = \nu\} \cap \{\#\{j > 1 : X_j = \nu_i\} = k\}.$$

Let $m = \frac{(d_{\nu_i}-1)\lambda}{1+(d_{\nu_i}-1)\lambda}$ and $c = \tilde{\mathcal{C}}(\lambda, \mathcal{T}^{\nu_i})$. Note that the sequence $(\mathcal{A}_k, k \geq 0)$ are pairwise disjoint and $\mathbb{P}(\mathcal{A}_k) = \frac{mc(m(1-c))^k}{d_0}$, therefore we obtain:

$$\tilde{\mathcal{C}}(\lambda, \mathcal{T}, \nu_i) = \frac{mc}{d_0} \sum_{k=0}^{\infty} (m(1-c))^k = \frac{(d_{\nu_i} - 1)\lambda \tilde{\mathcal{C}}(\lambda, \mathcal{T}^{\nu_i})}{d_0(1 + (d_{\nu_i} - 1)\lambda \tilde{\mathcal{C}}(\lambda, \mathcal{T}^{\nu_i}))}. \quad \square$$

Proof of proposition 30. First, since $\mathcal{T}^{\infty, \mathcal{T}}$ is a periodic tree, therefore the biased random walk RW_{λ_c} on $\mathcal{T}^{\infty, \mathcal{T}}$ is recurrent (see [14]). Recall that $L(\mathcal{T})$ is the set of all leafs of finite tree \mathcal{T} and S^i be the set of all finite paths starting at origin, ending at one element of $L(\mathcal{T})$ and pass through ν_i . For all $\nu \in L(\mathcal{T})$, we have $(\mathcal{T}^{\infty, \mathcal{T}})^{\nu} = \mathcal{T}^{\infty, \mathcal{T}}$ and we apply several times successive Lemma 31 to obtain:

$$\tilde{\mathcal{C}}(\lambda, \mathcal{T}^{\infty, \mathcal{T}}, \nu_i) = \sum_{\gamma \in S^i} f_1^{\gamma}(\lambda) f_2^{\gamma}(\lambda) \cdots f_{|\gamma|}^{\gamma}(\lambda) \tilde{\mathcal{C}}(\lambda, (\mathcal{T}^{\infty, \mathcal{T}})^{\gamma_{|\gamma|}}),$$

where $f_j^{\gamma}(\lambda) = \frac{m_{\gamma_j} \lambda}{m_{\gamma_{j-1}}(1 + m_{\gamma_j} \lambda \mathcal{C}(\lambda, \mathcal{T}^{\gamma_j}))}$ and $m_{\gamma_j} = d_{\gamma_j} - 1$ if $j > 1$ and $m_{\gamma_0} = d_0$. Moreover, we have

$$\tilde{\mathcal{C}}(\lambda, (\mathcal{T}^{\infty, \mathcal{T}})^{\gamma_{|\gamma|}}) = \tilde{\mathcal{C}}(\lambda, \mathcal{T}^{\infty, \mathcal{T}})$$

then

$$\tilde{\mathcal{C}}(\lambda, \mathcal{T}^{\infty, \mathcal{T}}, \nu_i) = \sum_{\gamma \in S^i} f_1^{\gamma}(\lambda) f_2^{\gamma}(\lambda) \cdots f_{|\gamma|}^{\gamma}(\lambda) \tilde{\mathcal{C}}(\lambda, \mathcal{T}^{\infty, \mathcal{T}}).$$

By Lemma 62, we obtain

$$\varphi^{\lambda, 1}(o, \nu_i) = \frac{\tilde{\mathcal{C}}(\lambda, \mathcal{T}^{\infty, \mathcal{T}}, \nu_i)}{\tilde{\mathcal{C}}(\lambda, \mathcal{T}^{\infty, \mathcal{T}})} = \sum_{\gamma \in S^i} f_1^{\gamma}(\lambda) f_2^{\gamma}(\lambda) \cdots f_{|\gamma|}^{\gamma}(\lambda).$$

Note that for all $\gamma \in S^i$ we have $m_{\gamma_0} = m(\gamma_{|\gamma|})$, this implies that $\varphi^{\lambda, 1}(o, \nu_i)$ converges when λ decreases towards $\lambda_c(\mathcal{T}^{\infty, \mathcal{T}})$ and

$$(3.4) \quad \lim_{\lambda \rightarrow \lambda_c(\mathcal{T}^{\infty, \mathcal{T}})} \varphi^{\lambda, 1}(\nu_i) = \sum_{\gamma \in S^i} \lambda_c^{|\gamma|}. \quad \square$$

Remark 32. The equation (3.4) gives us a way to calculate the critical value of RW_{λ} on $\mathcal{T}^{\infty, \mathcal{T}}$, as the solution of the following equation:

$$\sum_{i=1}^{m_o} \sum_{\gamma \in S^i} x^{|\gamma|} = 1.$$

4. THE CONTINUITY OF EFFECTIVE CONDUCTANCE

We end the first half of the paper with a few results on the conductance functions of trees, namely we prove a criterion for the continuity of $\mathcal{C}(\lambda, \mathcal{T})$ in λ (see Theorems 35 and 36 below) and study the set of conductance functions of spherically symmetric trees of bounded degree (see Theorem 4).

4.1. Left- and right-continuity of $\mathcal{C}(\mathcal{T}, \lambda)$.

Lemma 33. *Let \mathcal{T} be an infinite, locally finite and rooted tree. Then $\mathcal{C}(\lambda, \mathcal{T})$ is right continuous on $(0, +\infty)$.*

Proof. Let $(X_n, n \geq 0)$ be the biased random walk with parameter λ on \mathcal{T} . We define $S_0 := \inf \{k > 0 : X_k = o\}$ and for any $n > 0$,

$$S_n := \inf \{k > 0 : d(o, X_k) = n\}.$$

Recall that the random walk on a network (\mathcal{T}, c) , where $c(e) = \lambda^{|e|}$ is exactly the same process as the biased random walk with parameter λ . We use Equation 2.1 to obtain

$$\mathcal{C}(\lambda, \mathcal{T}) = \pi(o) \lim_{n \rightarrow +\infty} \mathbb{P}(S_n < S_0).$$

We set $\mathcal{C}(\lambda, \mathcal{T}, n) := \pi(o) \mathbb{P}(S_n < S_0)$. It is easy to see that $\mathcal{C}(\lambda, \mathcal{T}, n) \geq \mathcal{C}(\lambda, \mathcal{T}, n+1)$. On the other hand, by Lemma 21, we obtain $\mathcal{C}(\lambda, \mathcal{T}, n)$ is a continuous function. Hence, $\mathcal{C}(\lambda, \mathcal{T}, n)$ is a continuous increasing function for each n . It implies that $\mathcal{C}(\lambda, \mathcal{T})$ is the decreasing limit of increasing functions. Therefore $\mathcal{C}(\lambda, \mathcal{T})$ is right continuous. \square

Definition 34. *Let \mathcal{T} be tree. For each $\nu \in \mathcal{T}$, we let X_n^ν denote the biased random walk on \mathcal{T}^ν (i.e $X_0^\nu = \nu$ and $\forall n > 0 : X_n^\nu \in \mathcal{T}^\nu$). We say that \mathcal{T} is uniformly transient if*

$$\forall \lambda > \lambda_c, \exists \alpha_\lambda > 0, \forall \nu \in \mathcal{T}, \mathbb{P}(\forall n > 0, X_n^\nu \neq \nu) \geq \alpha_\lambda.$$

It is called weakly uniformly transient if there exists a sequence of finite pairwise disjoint V -cutsets $(\pi_n, n \geq 1)$, such that

$$\forall \lambda > \lambda_c, \exists \alpha_\lambda > 0, \forall \nu \in \bigcup_{k=1}^{+\infty} \pi_k, \mathbb{P}(\forall n > 0, X_n^\nu \neq \nu) \geq \alpha_\lambda.$$

It is easy to see that if $\lambda_c(\mathcal{T}) = 1$, then \mathcal{T} is uniformly transient.

Theorem 35. *Let \mathcal{T} be a uniformly transient tree. Then $\mathcal{C}(\lambda, \mathcal{T})$ is left continuous on $(\lambda_c, +\infty)$.*

Proof. Fix $\lambda_1 > \lambda_c$, we will prove that $\mathcal{C}(\lambda, \mathcal{T})$ is left continuous at λ_1 . Choose $\lambda_0 \in (\lambda_c, \lambda_1)$. By Theorem 14, we can find a constant $\alpha > 0$ (does not depend on $\lambda \in [\lambda_0, \lambda_1]$) such that

$$\forall \lambda \in [\lambda_0, \lambda_1], \forall \nu \in V(\mathcal{T}), \mathbb{P}(\forall n > 0, X_n^\nu \neq \nu) \geq \alpha.$$

Given a family of conductances $c = c(e)_{e \in E(\mathcal{T})} \in (0, +\infty)^E$, let Y_n be the associated random walk. Let $A \subset (0, +\infty)^E$ be the subset of elements of $(0, +\infty)^E$ such that Y_n is transient for those choices of conductances. Then we define the function $\psi : A \rightarrow \mathbb{R}_+^*$ as

$$\psi(c) := \mathcal{C}_c(\mathcal{T}).$$

Recall that \mathcal{T}_k is the collection of all the vertices at distance k from the root: then we have

$$\mathcal{C}(\lambda, \mathcal{T}) = \psi(\underbrace{\lambda, \lambda, \dots, \lambda}_{|\mathcal{T}_1|}, \underbrace{\lambda^2, \lambda^2, \dots, \lambda^2}_{|\mathcal{T}_2|}, \dots).$$

We will abuse notation until the end of the argument, writing

$$\psi(\lambda_1, \lambda_2^2, \lambda_3^3, \dots) \quad \text{for} \quad \psi(\underbrace{\lambda_1, \lambda_1, \dots, \lambda_1}_{|\mathcal{T}_1|}, \underbrace{\lambda_2^2, \lambda_2^2, \dots, \lambda_2^2}_{|\mathcal{T}_2|}, \dots)$$

so that in particular $\mathcal{C}(\lambda, \mathcal{T}) = \psi(\lambda, \lambda^2, \lambda^3, \dots)$.

Let $\varepsilon > 0$, we choose $L \in \mathbb{N}$ such that $(1 - \alpha)^L < \varepsilon$. For $\lambda \in (\lambda_0, \lambda_1)$ we have $|\mathcal{C}(\lambda_1, \mathcal{T}) - \mathcal{C}(\lambda, \mathcal{T})| = |\psi(\lambda_1, \lambda_1^2, \lambda_1^3, \dots) - \psi(\lambda, \lambda^2, \lambda^3, \dots)|$ and by the triangular inequality, we get

$$(4.1) \quad \begin{aligned} |\mathcal{C}(\lambda_1, \mathcal{T}) - \mathcal{C}(\lambda, \mathcal{T})| &\leq |\psi(\lambda_1, \dots, \lambda_1^L, b_1) - \psi(\lambda, \dots, \lambda^L, b_1)| \\ &\quad + |\psi(\lambda, \dots, \lambda^L, b_1) - \psi(\lambda, \dots, \lambda^L, b)| \end{aligned}$$

where $b := (\lambda^{L+k})_{k \geq 1}$ and $b_1 := (\lambda_1^{L+k})_{k \geq 1}$.

Let $\lambda' \in [\lambda_0, \lambda_1]$ we denote $S_n^{\lambda'}$ the first hitting point of \mathcal{T}_n by the random walk with conductances

$$\underbrace{(\lambda, \dots, \lambda)}_{|\mathcal{T}_1|}, \underbrace{\lambda^2, \dots, \lambda^2}_{|\mathcal{T}_2|}, \dots, \underbrace{\lambda^L, \dots, \lambda^L}_{|\mathcal{T}_L|}, \underbrace{(\lambda')^{L+1}, \dots, (\lambda')^{L+1}}_{|\mathcal{T}_{L+1}|}, \dots$$

We can see that the law of $S_L^{\lambda_1}$ and the law of S_L^λ are identical. Since \mathcal{T} is uniformly transient, then when the random walk reaches \mathcal{T}_L , it returns to o with a probability strictly smaller than $(1 - \alpha)^L$. It implies that

$$(4.2) \quad |\psi(\lambda, \dots, \lambda^L, b_1) - \psi(\lambda, \dots, \lambda^L, b)| \leq 2(1 - \alpha)^L \leq 2\varepsilon.$$

It remains to estimate $|\psi(\lambda_1, \dots, \lambda_1^L, b_1) - \psi(\lambda, \dots, \lambda^L, b_1)|$. By Theorem 14, we have

$$\psi(\lambda_1, \dots, \lambda_1^L, b_1) \geq \mathcal{C}(\lambda_0, \mathcal{T}) > 0 \quad \text{and} \quad \psi(\lambda, \dots, \lambda^L, b) \geq \mathcal{C}(\lambda_0, \mathcal{T}) > 0.$$

We apply the Lemma 21 to obtain

$$(4.3) \quad \exists \delta > 0, \forall \lambda \in [\lambda_1 - \delta, \lambda_1], |\psi(\lambda_1, \dots, \lambda_1^L, b_1) - \psi(\lambda, \dots, \lambda^L, b_1)| < \varepsilon.$$

We combine (4.1), (4.2) and (4.3) to get

$$\exists \delta > 0, \forall \lambda \in [\lambda_0, \lambda_1] \text{ such that } \lambda_1 - \lambda < \delta : |\mathcal{C}(\lambda_1, \mathcal{T}) - \mathcal{C}(\lambda, \mathcal{T})| \leq 3\varepsilon.$$

This implies that $\mathcal{C}(\lambda, \mathcal{T})$ is left continuous at λ_1 . \square

In the same method as in the proof of Theorem 35, we can prove the slightly stronger result (the proof of which we omit):

Theorem 36. *Let \mathcal{T} be a weakly uniformly transient tree: then the effective conductance $\mathcal{C}(\lambda, \mathcal{T})$ is left continuous on $(\lambda_c, 1]$.*

4.2. Proof of Theorem 4.

Definition 37. Let $(\mathcal{T}^n, n \geq 1)$ be a sequence of infinite, locally finite and rooted trees. We say that \mathcal{T}^n converges locally towards \mathcal{T}^∞ if $\forall k, \exists n_0, \forall n \geq n_0, \mathcal{T}_{\leq k}^n = \mathcal{T}_{\leq k}^\infty$, where $\mathcal{T}_{\leq k}$ is a finite tree defined by:

$$\begin{cases} V(\mathcal{T}_{\leq k}) := \{\nu \in V(\mathcal{T}), d(o, \nu) \leq k\} \\ E(\mathcal{T}_{\leq k}) = E|_{V(\mathcal{T}_{\leq k}) \times V(\mathcal{T}_{\leq k})} \end{cases}$$

Recall from the introduction that \mathbb{F}_m denotes the collection of all effective conductance functions for spherically symmetric trees with degree uniformly bounded by m .

Lemma 38. Let $(f_n, n \geq 1)$ be a sequence of functions in \mathbb{F}_m . Assume that f_n converges uniformly towards f . Then, there exists a function $g \in \mathbb{F}_m$ such that, for any $\lambda > 0$,

$$f(\lambda) \leq g(\lambda).$$

Proof. Let $(\mathcal{T}^n, n \geq 1)$ be a sequence of elements of A_m such that, for any $n > 0$,

$$f_n(\lambda) = \mathcal{C}(\lambda, \mathcal{T}^n).$$

Since the degree of vertices of \mathcal{T}^n are bounded by m , we can apply the diagonal extraction argument. After renumbering indices, there exists a subsequence of $(\mathcal{T}^n, n \geq 1)$, denoted also by $(\mathcal{T}^n, n \geq 1)$, converges locally towards some tree, denote by \mathcal{T}^∞ . Moreover, we can assume that for any $n > 0$,

$$(4.4) \quad \mathcal{T}_{\leq n}^n = \mathcal{T}_{\leq n}^\infty$$

Since for any $n > 0$, we have $\mathcal{T}^n \in A_m$, then

$$(4.5) \quad \mathcal{T}^\infty \in A_m$$

We set $g(\lambda) = \mathcal{C}(\lambda, \mathcal{T}^\infty)$, it remains to show that for any $\lambda > 0$,

$$f(\lambda) \leq g(\lambda).$$

Assume that there exists λ_0 such that $f(\lambda_0) > g(\lambda_0)$ and we set $c = f(\lambda_0) - g(\lambda_0) > 0$. Since the sequence $(f_n(\lambda_0), n \geq 1)$ converges towards $f(\lambda_0)$, hence

$$(4.6) \quad \exists \ell_1 > 0, \forall n \geq \ell_1, f_n(\lambda_0) > f(\lambda_0) - \frac{c}{4}.$$

Recall the definition of the function $\mathcal{C}(\lambda_0, \mathcal{T}, n)$ in the proof of Lemma 33, the sequence $(\mathcal{C}(\lambda_0, \mathcal{T}^\infty, n), n \geq 1)$ decreases towards $g(\lambda_0)$, it implies that

$$(4.7) \quad \exists \ell_2 > 0, \forall n \geq \ell_2, \mathcal{C}(\lambda_0, \mathcal{T}^\infty, n) < g(\lambda_0) + \frac{c}{4}.$$

Let $\ell := \ell_1 \vee \ell_2$, we use 4.6 and 4.7 to obtain:

$$(4.8) \quad f_\ell(\lambda_0) > f(\lambda_0) - \frac{c}{4} \quad \text{and} \quad \mathcal{C}(\lambda_0, \mathcal{T}^\infty, \ell) < g(\lambda_0) + \frac{c}{4}.$$

On the other hand $\mathcal{C}(\lambda_0, \mathcal{T}^\ell, \ell) = \mathcal{C}(\lambda_0, \mathcal{T}^\infty, \ell)$ and by 4.9 we obtain:

$$(4.9) \quad f_\ell(\lambda_0) > f(\lambda_0) - \frac{c}{4} \quad \text{and} \quad \mathcal{C}(\lambda_0, \mathcal{T}^\ell, \ell) < g(\lambda_0) + \frac{c}{4}.$$

The sequence $(\mathcal{C}(\lambda_0, \mathcal{T}^\ell, k), k \geq 1)$ decreases towards $f_\ell(\lambda_0)$ when k goes to $+\infty$. Hence,

$$(4.10) \quad f_\ell(\lambda_0) \leq \mathcal{C}(\lambda_0, \mathcal{T}^\ell, \ell) < g(\lambda_0) + \frac{c}{4}.$$

We combine 4.9 and 4.10 to get:

$$f(\lambda_0) - \frac{c}{4} < f_\ell(\lambda_0) < g(\lambda_0) + \frac{c}{4}.$$

Hence,

$$c = f(\lambda_0) - g(\lambda_0) < \frac{c}{4},$$

this is a contradiction. \square

Proof of theorem 4. Let $(\mathcal{T}^n, n \geq 1)$ be a sequence of elements of A_m such that, for any $n > 0$,

$$f_n(\lambda) = \mathcal{C}(\lambda, \mathcal{T}^n).$$

Fix a sub-sequence of $(\mathcal{T}^n, n \geq 1)$ which converges locally towards \mathcal{T}^∞ and such that 4.4 holds as in the proof of the Lemma 38. We set $g(\lambda) = \mathcal{C}(\lambda, \mathcal{T}^\infty)$ and we need to prove that $f = g$.

By Lemma 38, we have $f(\lambda) \leq g(\lambda)$. Assume that there exists λ_0 such that $0 < f(\lambda_0) < g(\lambda_0)$. We prove that for any $\lambda < \lambda_0$, we have $f(\lambda) = 0$.

We set $\beta_0 = \frac{1}{\lambda_0}$ and we use Proposition 16 to obtain

$$(4.11) \quad \begin{cases} \forall n > 0, \mathcal{R}(\lambda_0, \mathcal{T}^n) = \sum_{k=1}^{+\infty} \frac{\beta_0^k}{|\mathcal{T}_k^n|} \\ \mathcal{R}(\lambda_0, \mathcal{T}^\infty) = \sum_{k=1}^{\infty} \frac{\beta_0^k}{|\mathcal{T}_k^\infty|} \end{cases}$$

We write

$$\mathcal{R}(\lambda_0, \mathcal{T}^n) = \sum_{k=1}^{+\infty} \frac{\beta_0^k}{|\mathcal{T}_k^n|} = \sum_{k \leq n} \frac{\beta_0^k}{|\mathcal{T}_k^n|} + \sum_{k > n} \frac{\beta_0^k}{|\mathcal{T}_k^n|}.$$

On the other hand, for any $k \leq n$ we have $|\mathcal{T}_k^n| = |\mathcal{T}_k^\infty|$, hence

$$(4.12) \quad \mathcal{R}(\lambda_0, \mathcal{T}^n) = \sum_{k \leq n} \frac{\beta_0^k}{|\mathcal{T}_k^\infty|} + \sum_{k > n} \frac{\beta_0^k}{|\mathcal{T}_k^n|}.$$

Since f_n converges to f , then

$$(4.13) \quad \begin{cases} \lim_{n \rightarrow \infty} \mathcal{R}(\lambda_0, \mathcal{T}^n) = \frac{1}{f(\lambda_0)} < \infty \\ \lim_{n \rightarrow \infty} \mathcal{R}(\lambda_0, \mathcal{T}^\infty) = \frac{1}{g(\lambda_0)} < \frac{1}{f(\lambda_0)} \end{cases}$$

By using 4.12 and 4.13, we obtain

$$(4.14) \quad \lim_{n \rightarrow +\infty} \sum_{k>n} \frac{\beta_0^k}{|\mathcal{T}_k^n|} = \frac{1}{f(\lambda_0)} - \frac{1}{g(\lambda_0)} > 0.$$

Now we take $\beta > \beta_0$ and we apply the Proposition 16 in order to get

$$(4.15) \quad \mathcal{R}\left(\frac{1}{\beta}, \mathcal{T}^n\right) = \sum_{k=0}^{+\infty} \frac{\beta^k}{|\mathcal{T}_k^n|} > \sum_{k>n} \frac{\beta^k}{|\mathcal{T}_k^n|} \geq \left(\frac{\beta}{\beta_0}\right)^n \sum_{k>n} \frac{\beta_0^k}{|\mathcal{T}_k^n|}.$$

We combine 4.14 and 4.15 to obtain:

$$(4.16) \quad \lim_{n \rightarrow \infty} \mathcal{R}\left(\frac{1}{\beta}, \mathcal{T}^n\right) = \infty$$

It implies that $f(1/\beta) = \lim_{n \rightarrow \infty} f_n\left(\frac{1}{\beta}\right) = \lim_{n \rightarrow \infty} \frac{1}{\mathcal{R}\left(\frac{1}{\beta}, \mathcal{T}^n\right)} = 0$. Therefore, we proved that:

$$\forall \lambda < \lambda_0, f(\lambda) = 0.$$

As $f \neq 0$, we define $\lambda_c := \inf \{0 \leq \lambda \leq 1 : f(\lambda) > 0\}$. We proved that

$$(4.17) \quad \forall \lambda > \lambda_c, f(\lambda) = g(\lambda).$$

As the sequence $(f_n)_n$ converges uniformly to f , then f is continuous, and then $f(\lambda_c) = 0$. By Lemma 33, g is right continuous. Then we obtain:

$$(4.18) \quad f(\lambda_c) = \lim_{\lambda \rightarrow \lambda_c^+} f(\lambda) = \lim_{\lambda \rightarrow \lambda_c^+} g(\lambda) = g(\lambda_c) = 0.$$

On the other hand, by Lemma 14 we obtain g is an increasing function, then:

$$(4.19) \quad \forall \lambda < \lambda_c, g(\lambda) = 0 = f(\lambda)$$

We combine 4.17, 4.18 and 4.19 to obtain $f = g$. □

5. SELF-AVOIDING WALKS

The main goal of this section is to prove Proposition 1 (Section 5.3) and Theorem 3 (Section 5.4).

5.1. Walks and bridges. In this section, we review some definitions on the self-avoiding walk, bridges and connective constant (see [16]). Denote by c_n the number of self-avoiding walks of length n , starting at origin on the considered graph. If \mathcal{G} is transitive, the sequence $c_n^{1/n}$ converges to a constant when n goes to infinity. This constant is called the connective constant of \mathcal{G} .

Definition 39. An n -step bridge in the plane \mathbb{Z}^2 (or half-plane \mathbb{H}) is an n -step self-avoiding walk (SAW) γ such that

$$\forall i = 1, 2, \dots, n, \quad \gamma_1(0) < \gamma_1(i) \leq \gamma_1(n)$$

where $\gamma_1(i)$ is the first coordinate of $\gamma(i)$. Let b_n denote the number of all n -step bridges with $\gamma(0) = 0$. By convention, set $b_0 = 1$.

We have $b_{m+n} \geq b_m \cdot b_n$, hence we can define

$$\mu_b = \lim_{n \rightarrow +\infty} b_n^{\frac{1}{n}} = \sup_n b_n^{\frac{1}{n}}.$$

Moreover, $b_n \leq \mu_b^n \leq \mu^n$.

Definition 40. Given a bridge γ of length n , γ is called an irreducible bridge if it can not be decomposed into two bridges of length strictly smaller than n . It means, we can not find $i \in [1, n-1]$ such that $\gamma|_{[0,i]}$, $\gamma|_{[i,n]}$ are two bridges. The set of all irreducible-bridges is denoted by $iSAW$.

5.2. Kesten's measure. For this section, we refer the reader to ([10],[4]) for a more precise description. Denote by SAW_∞ the set of all self-avoiding walks on the plane \mathbb{Z}^2 or half-plane \mathbb{H} . In this section, we review the Kesten measure. He defined a probability measure on the SAW_∞ of half-plane from the finite bridges. We use \mathbb{B} (resp. \mathbb{I}) to denote the set of bridges (resp. irreducible bridges) starting at origin. Let p_n denote the number of irreducible bridges starting at origin, of length n .

We define a notion of concatenation of paths. If $\gamma^1 = [\gamma^1(0), \gamma^1(1), \dots, \gamma^1(m)]$ and $\gamma^2 = [\gamma^2(0), \gamma^2(1), \dots, \gamma^2(n)]$ are two SAWs, we define $\gamma^1 \oplus \gamma^2$ to be the $(m+n)$ -step walk (not necessarily self-avoiding walk)

$$\gamma^1 \oplus \gamma^2 := [0, \gamma^1(1), \dots, \gamma^1(m), \gamma^1(m) + \gamma^2(1) - \gamma^2(0), \dots, \gamma^1(m) + \gamma^2(n) - \gamma^2(0)].$$

Similarly, we can define $\gamma^1 \oplus \gamma^2 \oplus \dots \oplus \gamma^k$. We begin with the following equality

Fact 41 (Kesten [10], Theorem 5). *We have*

$$\sum_{n=1}^{+\infty} \frac{p_n}{\mu^n} = 1.$$

Remark 42. *We have also $\sum_{\omega \in \mathbb{I}} \beta^{|\omega|} < \infty$ if $\beta < \frac{1}{\mu}$ and if $\beta > \frac{1}{\mu}$ then $\sum_{\omega \in \mathbb{I}} \beta^{|\omega|} = \infty$.*

Let us now define the Kesten measure on the SAW_∞ in the half-plane. We fix $\beta \leq \frac{1}{\mu}$ and let \mathbb{Q}^β denote the probability measure on \mathbb{I} defined by

$$\mathbb{Q}^\beta(\omega) = \frac{\beta^{|\omega|}}{Z_\beta}, \omega \in \mathbb{I}$$

where $Z_\beta = \sum_{\omega \in \mathbb{I}} \beta^{|\omega|}$. By Fact 41 and Remark 42, Z_β is finite and thus \mathbb{Q}^β is a probability measure on \mathbb{I} .

Let $k \geq 1$, we consider the product space \mathbb{I}^k and define the product probability measure \mathbb{Q}_k^β . We write \mathbb{Q}_k^β for an extension to SAW in \mathbb{H} as follows, $\mathbb{Q}^\beta(\omega) = 0$ if ω is not of form $\omega^1 \oplus \omega^2 \oplus \dots \oplus \omega^k$ and

$$\mathbb{Q}_k^\beta(\mathbb{H} \setminus \mathbb{I}^k) = 0; \mathbb{Q}_k^\beta(\omega^1 \oplus \omega^2 \oplus \dots \oplus \omega^k) = \mathbb{Q}^\beta(\omega^1) \times \mathbb{Q}^\beta(\omega^2) \times \dots \times \mathbb{Q}^\beta(\omega^k).$$

We define \mathbb{Q}_∞^β on \mathbb{I}^∞ , it is called the β -Kesten measure on SAW_∞ in the half-plane.

Fact 43. *Under the β -Kesten measure, the infinite self-avoiding walk, denoted by $\omega_K^{\infty, \beta}$, almost surely does not reach the line $\mathbb{Z} \times \{0\}$.*

Proof. It follows immediately from the definition of β -Kesten measure. \square

5.3. Proof of Proposition 1.

Notation 44. *Consider the self-avoiding walks in the lattice \mathbb{Z}^2 starting at the origin. We construct a tree $\mathcal{T}_{\mathbb{Z}^2}$, which is called self-avoiding tree, from these self-avoiding walks: The vertices of $\mathcal{T}_{\mathbb{Z}^2}$ are the finite self-avoiding walks and two such vertices joined when one path is an extension by one step of the other. Formally, denote by Ω_n the set of self-avoiding walks of length n starting at the origin and $V := \bigcup_{n=0}^{+\infty} \Omega_n$. Two elements $x, y \in V$ are adjacent if one path is an extension by one step of the other. We then define $\mathcal{T}_{\mathbb{Z}^2} = (V, E)$. In the same way, we can define other self-avoiding trees $\mathcal{T}_{\mathbb{H}}, \mathcal{T}_{\mathbb{Q}}$, where \mathbb{H} is a half-plane and \mathbb{Q} is a quarter-plane.*

Remark 45. *Note that each vertex (resp. a ray) of $\mathcal{T}_{\mathbb{Z}^2}$ (or $\mathcal{T}_{\mathbb{H}}, \mathcal{T}_{\mathbb{Q}}$) is a finite self-avoiding walk (resp. an infinite self-avoiding walk). Moreover, it is easy to see that the number of vertices at generation n of $\mathcal{T}_{\mathbb{Z}^2}$ (or $\mathcal{T}_{\mathbb{H}}, \mathcal{T}_{\mathbb{Q}}$) is the number of self-avoiding walks of length n in \mathbb{Z}^2 (resp. \mathbb{H}, \mathbb{Q}).*

Notation 46. *In [10], Kesten proved that all bridges in a half-plane can be decomposed into a sequence of irreducible bridges in a unique way. For every $m \in \mathbb{N}^*$, we set:*

$$A_m := \{\omega \in iSAB, |\omega| \leq m\}.$$

An infinite self-avoiding walk starting at origin, is called "m-good" if it possesses a decomposition into irreducible bridges in A_m . Denote by G_m the set of infinite self-avoiding walk which are "m-good". Let \mathcal{T}^m be the subtree of $\mathcal{T}_{\mathbb{Z}^2}$, which we will refer to as the m-good tree, defined by $E(\mathcal{T}^m) := E(\mathcal{T}_{\mathbb{Z}^2})|_{V(\mathcal{T}^m) \times V(\mathcal{T}^m)}$ where,

$$V(\mathcal{T}^m) := \{\omega \in V(\mathcal{T}_{\mathbb{Z}^2}) : \text{there exists } \gamma \in G_m \text{ such that } \gamma|_{[0, |\omega|]} = \omega\}.$$

Proposition 47. *Let $T_{\mathbb{H}}, T_{\mathbb{Q}}$ be defined as above. Then,*

$$gr(\mathcal{T}_{\mathbb{Z}^2}) = br(\mathcal{T}_{\mathbb{Z}^2}) = gr(T_{\mathbb{H}}) = br(T_{\mathbb{H}}) = gr(T_{\mathbb{Q}}) = br(T_{\mathbb{Q}}) = \mu,$$

where μ is the connective constant of the lattice \mathbb{Z}^2 .

Proof. As explained in the introduction, there are rather large classes of trees, including $\mathcal{T}_{\mathbb{Z}^2}$, for which the branching and growth coincide (for instance, this holds for sub- or super-periodic trees, cf. below, or for typical supercritical Galton-Watson trees), but none of the classical results seem to apply to $\mathcal{T}_{\mathbb{H}}$ or $\mathcal{T}_{\mathbb{Q}}$.

Note that $\mathcal{T}_{\mathbb{Z}^2}$ is a sub-periodic tree, by Theorem 12 and the definition of connective constant, we have

$$(5.1) \quad gr(\mathcal{T}_{\mathbb{Z}^2}) = br(\mathcal{T}_{\mathbb{Z}^2}) = \mu.$$

We know that (see [1], [8]) there exists a constant B and $n_0 \in \mathbb{N}$ such that for any $n > n_0$, we have:

$$(5.2) \quad c_n \leq b_n e^{B\sqrt{n}}$$

We use 5.2 to obtain:

$$(5.3) \quad \mu \leq \lim_{n \rightarrow \infty} (b_n)^{\frac{1}{n}} \leq gr(\mathcal{T}_{\mathbb{H}}) \leq gr(\mathcal{T}_{\mathbb{Z}^2}) = \mu.$$

Hence,

$$(5.4) \quad gr(\mathcal{T}_{\mathbb{H}}) = \mu.$$

By Proposition 8, we have:

$$(5.5) \quad br(\mathcal{T}_{\mathbb{H}}) \leq \mu.$$

Let $b_n^{(m)}$ be the number of bridges of length n which possess a decomposition into irreducible bridges in A_m . Recall that $(\mathcal{T}^m)_n$ is the number of vertices of \mathcal{T}^m at generation n . Then for any $n > 0$, we have

$$(5.6) \quad |(\mathcal{T}^m)_n| \geq b_n^{(m)}.$$

Note that \mathcal{T}^m is also a sub-tree of $\mathcal{T}_{\mathbb{H}}$, then by Remark 7 we have :

$$(5.7) \quad br(\mathcal{T}^m) \leq br(\mathcal{T}_{\mathbb{H}}).$$

On the other hand, \mathcal{T}^m is m -super-periodic, so we can apply Theorem 12 to get $gr(\mathcal{T}^m)$ exists and,

$$(5.8) \quad br(\mathcal{T}^m) = gr(\mathcal{T}^m).$$

We use 5.7 and 5.8 to obtain, for any $m > 0$,

$$(5.9) \quad br(\mathcal{T}_{\mathbb{H}}) \geq gr(\mathcal{T}^m).$$

It remains to prove that $\lim_{n \rightarrow \infty} gr(\mathcal{T}^m) = \mu$. By using 5.3 and noting that the concatenation of two bridges is another bridge, we see that for any m, n :

$$(5.10) \quad b_{m+n} \geq b_m b_n \quad \text{and} \quad b_{n_1+n_2}^{(m)} \geq b_{n_1}^{(m)} b_{n_2}^{(m)} \quad \text{and} \quad \lim_{n \rightarrow \infty} (b_n)^{\frac{1}{n}} = \mu.$$

By 5.10 and super-additivity lemma, we can define:

$$(5.11) \quad \mu_m := \lim_{n \rightarrow \infty} (b_n^{(m)})^{\frac{1}{n}} \quad \text{and} \quad b_n^{(m)} \leq (\mu_m)^n \quad \text{for all } n > 0.$$

Fix $\varepsilon > 0$, by 5.10 there exists m_0 such that for all $m \geq m_0$,

$$(5.12) \quad \left| \mu - (b_m)^{\frac{1}{m}} \right| \leq \varepsilon.$$

As we know (see paragraph 46) all bridges in a half-plane can be decomposed into a sequence of irreducible bridges in a unique way. Therefore each bridge in a half-plane of length m possesses a decomposition into irreducible bridges in A_m . Hence, for any $m > m_0$,

$$(5.13) \quad b_m = b_m^{(m)}.$$

We use 5.10, 5.11, 5.12 and 5.13 to obtain, for any $m > m_0$,

$$(5.14) \quad \mu_m \geq (b_{km}^{(m)})^{\frac{1}{km}} \geq ((b_m^{(m)})^k)^{\frac{1}{km}} = (b_m^{(m)})^{\frac{1}{m}} = (b_m)^{\frac{1}{m}} \geq \mu - \varepsilon.$$

By 5.11, the sequence $(b_\ell^{(m)})^{\frac{1}{\ell}}$ increases toward μ_m when ℓ goes to infinity, then $(b_{km}^{(m)})^{\frac{1}{km}} \xrightarrow[k \rightarrow \infty]{} \mu_m$. By using 5.6 and 5.14, for any $m > m_0$, we have $\mu \geq gr(\mathcal{T}^m) \geq \mu_m \geq \mu - \varepsilon$ and then,

$$(5.15) \quad \lim_{n \rightarrow \infty} gr(\mathcal{T}^m) = \mu.$$

We combine 5.5, 5.9 and 5.15 to obtain $br(\mathcal{T}_{\mathbb{H}}) = \mu$. By following a strategy similar to the proof of the case $\mathcal{T}_{\mathbb{H}}$, we obtain $gr(\mathcal{T}_{\mathbb{Q}}) = br(\mathcal{T}_{\mathbb{Q}}) = \mu$. \square

Proposition 1 is a consequence of Theorem 20 and Proposition 47.

5.4. Proof of Theorem 3. Now, we apply the results in Section 4.1 for the self-avoiding trees $\mathcal{T}_{\mathbb{Q}}$, $\mathcal{T}_{\mathbb{H}}$ and $\mathcal{T}_{\mathbb{Z}^2}$.

Notation. For any $n \in \mathbb{N}$, let $\Lambda_n := \llbracket -n, n \rrbracket^2$ be a subdomain of \mathbb{Z}^2 . Denote by $\partial\Lambda_n$ the boundary of Λ_n , i.e.,

$$\partial\Lambda_n := \{(a, b) \in \Lambda_n : |a| = n \text{ or } |b| = n\}.$$

We write $\overset{\circ}{\Lambda}_n := \Lambda_n \setminus \partial\Lambda_n$ for the interior of Λ_n .

Let γ be a finite self-avoiding walk. We say that γ is a *self-avoiding walk of domain* Λ_n if for any $0 \leq k \leq |\gamma|$, we have $\gamma(k) \in \Lambda_n$. Denote by $\Omega(\Lambda_n)$ the set of self-avoiding walks starting at origin of domain Λ_n .

Lemma 48. *The functions $\mathcal{C}(\lambda, \mathcal{T}_{\mathbb{Q}})$, $\mathcal{C}(\lambda, \mathcal{T}_{\mathbb{H}})$ and $\mathcal{C}(\lambda, \mathcal{T}_{\mathbb{Z}^2})$ are right continuous on $(\lambda_c, +\infty)$.*

Proof. It follows immediately from Lemma 33. \square

Lemma 49. *The functions $\mathcal{C}(\lambda, \mathcal{T}_{\mathbb{Q}})$, $\mathcal{C}(\lambda, \mathcal{T}_{\mathbb{H}})$ and $\mathcal{C}(\lambda, \mathcal{T}_{\mathbb{Z}^2})$ are left continuous on $(\lambda_c, +\infty)$.*

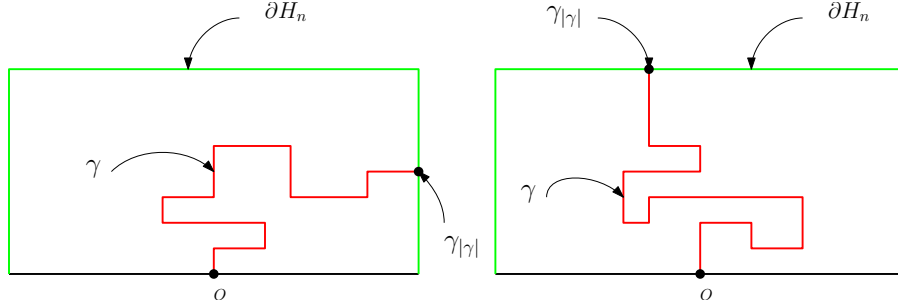

FIGURE 2. The boundary of \mathbb{H}_n is green and the self-avoiding walk γ is red. Recall that γ is a vertex of the tree $\mathcal{T}_{\mathbb{H}}$. On the left (resp. right), we can add a new quadrant \mathbb{Q} (resp. new half-plane \mathbb{H}) rooted at $\gamma|_{\gamma|}$. Hence, on the left (resp. on the right) the sub-tree $(\mathcal{T}_{\mathbb{H}})^\gamma$ contains the tree $\mathcal{T}_{\mathbb{Q}}$ (resp. $\mathcal{T}_{\mathbb{H}}$).

Proof. We prove this Lemma for the case $\mathcal{T}_{\mathbb{H}}$ and we use the same argument for other cases ($\mathcal{T}_{\mathbb{Q}}$ and $\mathcal{T}_{\mathbb{Z}^2}$). Note that $\mathcal{T}_{\mathbb{H}}$ is not uniformly transient, therefore we can not use Theorem 35. Fortunately, we can prove that $\mathcal{T}_{\mathbb{H}}$ is weakly uniformly transient. For this purpose, we define a sequence of cutsets $(\pi_n, n \geq 1)$ as follows. Set $\mathbb{H}_n := \Lambda_n \cap \mathbb{H}$ and $\partial\mathbb{H}_n := (\partial\Lambda_n) \cap \mathbb{H}$ (see Figure 2). Recall that $\Omega(\mathbb{H}_n)$ is the set of self-avoiding walks of domain \mathbb{H}_n . For any $n \geq 1$,

$$\pi_n := \left\{ \gamma \in \Omega(\mathbb{H}_n) : \text{for any } 0 \leq k < |\gamma|, \gamma(k) \in \overset{\circ}{\mathbb{H}}_n \text{ and } \gamma|_{\gamma|} \in \partial(\mathbb{H}_n) \right\}$$

Since \mathbb{H}_n is a finite domain of \mathbb{H} , therefore any infinite self-avoiding walk starting at origin of \mathbb{H} , must touch the boundary of \mathbb{H}_n . Hence, for any $n \geq 1$, we have π_n is a V-cutset of $\mathcal{T}_{\mathbb{H}}$. We set $\Gamma := \bigcup_{n \geq 1} \pi_n$, it remains to verify that:

$$(5.16) \quad \forall \lambda > \lambda_c (= \frac{1}{\mu}), \exists \alpha_\lambda > 0, \forall \nu \in \Gamma, \mathbb{P}(\forall n > 0, X_n^\nu \neq \nu) \geq \alpha_\lambda.$$

Note that for any $\gamma \in \Gamma$, the sub-tree $(\mathcal{T}_{\mathbb{H}})^\gamma$ contains the tree $\mathcal{T}_{\mathbb{H}}$ or $\mathcal{T}_{\mathbb{Q}}$ (see Figure 2). Hence, 5.16 is a consequence of Proposition 1 and Theorem 14. We use Theorem 36 to complete the proof of Lemma. \square

Theorem 4 is a consequence of Lemmas 48 and 49.

6. THE BIASED WALK ON THE SELF-AVOIDING TREE

We now begin the study of our main object of interest, which is the biased random walk on the self-avoiding tree. We will use the results that were obtained in the previous section to prove the properties of the limit walk. In the next section, we will gather a few natural conjectures.

6.1. The limit walk. Let $\lambda \in [0, +\infty]$ and consider the biased random walk RW_λ on \mathcal{T} where $\mathcal{T} = \mathcal{T}_{\mathbb{H}}$ or $\mathcal{T} = \mathcal{T}_{\mathbb{Z}^2}$. For $\lambda > \lambda_c$, the biased random walk is transient so almost surely, the random walk does not visit \mathcal{T}_k anymore after a sufficiently large time. We can then define the limit walk, as denoted by ω_λ^∞ in the following way:

$$\omega_\lambda^\infty(i) = x_i \iff \left\{ \begin{array}{l} x_i \in \mathcal{T}_i \\ \exists n_0, \forall n > n_0 : X_n \in \mathcal{T}^{x_i} \end{array} \right\}.$$

ω_λ^∞ is a random ray. Let $\mathbb{P}_\lambda^{\mathbb{H}}$ denote the law of ω_λ^∞ in the half-plane \mathbb{H} and $\mathbb{P}_\lambda^{\mathbb{Z}^2}$, the law of ω_λ^∞ in the plane \mathbb{Z}^2 . We can see $\mathbb{P}_\lambda^{\mathbb{H}}$ (respectively $\mathbb{P}_\lambda^{\mathbb{Z}^2}$) as a probability measure on SAW_∞ in the half-plane (respectively the plane).

For what follows, it will be useful to have the following definition: removing all the finite branches of \mathcal{T}_R (where R is a regular lattice), leads to a new tree without leaf, which we will denote by $\tilde{\mathcal{T}}_R$.

6.2. The case $\lambda = +\infty$ and percolation. First, we review some definitions of percolation theory. Percolation was introduced by Broadbent and Hammersley in 1957 (see [3]). For $p \in [0, 1]$, we consider the triangular lattice \mathbb{T} , a site of \mathbb{T} is open with probability p or closed with probability $1 - p$, independently of the others. This can also be seen as a random colouring (in black or white) of the faces of hexagonal lattice \mathbb{T}^* dual of \mathbb{T} .

We define the exploration curve as follows (see [21], section 6.1.2 for more detail). Let Ω be a simply connected subgraph of the triangular lattice and A, B be two points on its boundary. We can then divide the hexagonal cells of $\partial\Omega$ into two arcs, going from A to B in two directions (clockwise and counter-clockwise). These arcs will be denoted by \mathbb{B} and \mathbb{W} such that $A, \mathbb{B}, B, \mathbb{W}$ is in the clockwise direction. Assume that all of the hexagons in \mathbb{B} are colored in black and that all of the hexagons in \mathbb{W} are colored in white. The color of the hexagonal faces in Ω is chosen at random (black with probability p and white with probability $1 - p$), independently of the others. We define the *exploration curve* γ starting at A and ending at B which separates the black component containing \mathbb{B} from the white component containing \mathbb{W} .

Then the exploration curve γ is a self-avoiding walk using the vertices and edges of hexagonal lattice \mathbb{T}^* . We can define this interface γ in an equivalent, dynamical way, informally described as follows. At each step, γ looks at its

three neighbors on the hexagonal lattice, one of which is occupied by the previous step of γ . For the next step, γ randomly chooses one of these neighbors that has not yet occupied by γ . If there is just one neighbor that has not yet been occupied, then we choose this neighbor and if there are two neighbors, then we choose the right neighbor with probability p and the left neighbor with probability $1 - p$.

We know that there exists $p_c \in [0, 1]$ such that for $p < p_c$ there is almost surely no infinite cluster, while for $p > p_c$ there is almost surely an infinite cluster. This parameter is called *critical point*. It is known that the critical point of site-percolation on the triangular lattice equals $\frac{1}{2}$. The lower bound of critical point was proven by Harris in [9]. A similar theorem in the case of bond percolation on square lattice was given by Kesten in [11], and the result on the triangular lattice is obtained in a similar fashion.

Now, take $\Omega = \mathbb{T}_+^*$, the half-plane of hexagonal lattice. The hexagons on the boundary of Ω ($\partial\Omega$) and on the right of origin (denoted by $\partial^+\Omega$) are colored in black and the hexagons on $\partial\Omega$ and on the left of origin ($\partial^-\Omega$) are colored in white. In this case, the exploration curve is an (random) infinite self-avoiding walk. Denote by $\mathcal{T}_{\mathbb{T}_+^*}$ the self-avoiding tree constructed from the self-avoiding walks in \mathbb{T}_+^* .

In the case $\lambda = +\infty$, one can reinterpret the second construction of the exploration curve as the limit walk ω^∞ on $\widetilde{\mathcal{T}}_{\mathbb{T}_+^*}$. This is very useful because every feature of the curve γ is also one for ω^∞ and can therefore be restated in terms of the biased walk on the self-avoiding tree. One of these properties is that γ almost surely reaches the boundary of Ω an infinite times, which follows from Russo-Seymour-Welsh type arguments. As we will see below, this property is still valid in the case RW_λ , for all $\lambda > \lambda_c$ (see Theorem 2).

6.3. Proof of Theorem 2. In this section, for any $z \in \mathbb{Z}^2$, we write $\Re z$ (resp. $\Im z$) for the real part (resp. imaginary part) of z . To prove the theorem 2, we need the following function (the ‘‘head of the snake’’):

$$p : x \in V(\mathcal{T}) \mapsto x_{|x|} \in \mathbb{Z}^2 \text{ where } \mathcal{T} = \mathcal{T}_{\mathbb{H}} \text{ or } \mathcal{T} = \mathcal{T}_{\mathbb{Z}^2}.$$

The proof of theorem 2 has several steps. In the first step, we study the trajectory of the biased random walk X_n . We prove that, under the measures $\mathbb{P}_\lambda^{\mathbb{H}}$ and $\mathbb{P}_\lambda^{\mathbb{Z}^2}$, $p(X_n)$ almost surely reaches the line $\mathbb{Z} \times \{0\}$. In the second step, we prove that it almost surely reaches the line $\mathbb{Z} \times \{0\}$ an infinite number of times. In the third step, we prove that under $\mathbb{P}_\lambda^{\mathbb{Z}^2}$, the limit walk almost surely reaches the line $\mathbb{Z} \times \{0\}$ an infinite number of times. In the last step, we prove that under $\mathbb{P}_\lambda^{\mathbb{H}}$, the limit walk almost surely reaches the line $\mathbb{Z} \times \{0\}$ an infinite number of times. For simplicity, we will write Y_n for $p(X_n)$.

6.3.1. The first step. In this step, we study the trajectory of RW_λ . We begin with the following simple lemma:

Lemma 50. *Let $\lambda > \lambda_c$ and consider the biased random walk RW_λ on $\mathcal{T}_{\mathbb{Z}^2}$ or $\mathcal{T}_{\mathbb{H}}$. Then almost surely $\limsup |\Re(Y_n)| = +\infty$.*

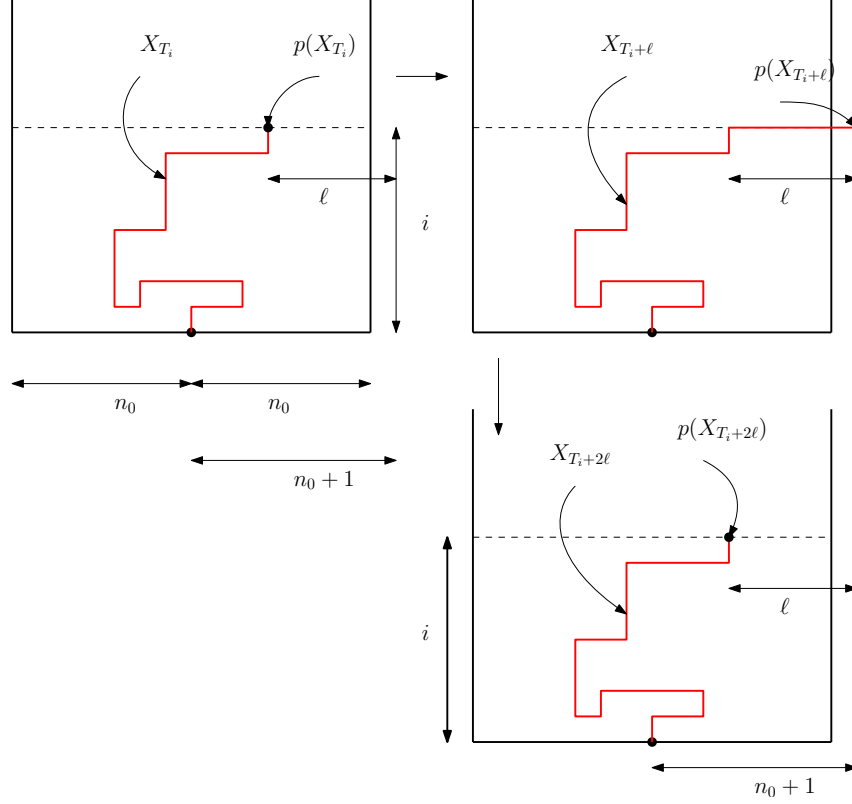

FIGURE 3. Illustration of the proof of Lemma 50

Proof. We prove the lemma in the case $\mathcal{T}_{\mathbb{H}}$; the result for $\mathcal{T}_{\mathbb{Z}^2}$ can be obtained in a similar way. The idea of the argument is straightforward: if the real part of $p(X_n)$ is constrained, then its imaginary part has to take large values and every time it visits a new height, the real part has a chance of becoming large: what follows is a formalization of this. Assume that $\alpha := \mathbb{P}(\limsup |\Re(Y_n)| < +\infty) > 0$, then there exists a constant $n_0 > 0$ such that,

$$(6.1) \quad \beta := \mathbb{P} \{ \text{for all } n > 0 : -n_0 \leq \Re(Y_n) \leq n_0 \} > 0.$$

For any $i \geq 0$, define

$$(6.2) \quad T(i) := \inf \{ n \geq 0 : \Im(Y_n) = i \}.$$

Note that $T(i) < +\infty$ on the event $\{\text{for all } n > 0 : -n_0 \leq \Re(Y_n) \leq n_0\}$. We remark that, at time $T(i)$, X can always go towards the left or the right. For

any $i \geq 0$, define

$$S_i := \{\exists! k : |\Re(Y_k)| = n_0 + 1, \Im(X_k) = i \text{ and } \forall n \neq k : -n_0 \leq \Re(Y_n) \leq n_0\}.$$

If the walk is at time $T(i)$, then we go towards the left or the right to reach the domain

$$\{\Re z = n_0 + 1\} \cup \{\Re z = -n_0 - 1\},$$

and after, we go back to $X_{T(i)}$ (see Figure 3). We need at most $2n_0$ steps to do this. Then, there exist a constant $c > 0$ such that for any $i > 0$,

$$(6.3) \quad \mathbb{P}(S_i) \geq c\beta.$$

On the other hand, we have

$$(6.4) \quad \bigcup_{i=0}^{+\infty} S_i \subset \{\text{for all } n \geq 0 : -n_0 - 1 \leq \Re(Y_n) \leq n_0 + 1\}.$$

Since these S_i are pairwise disjoint, by using 6.3 and 6.4 we obtain:

$$\mathbb{P}(\text{for all } n \geq 0 : -n_0 - 1 \leq \Re(Y_n) \leq n_0 + 1) \geq \sum_{i=0}^{\infty} \mathbb{P}(S_i) \geq \sum_{i=0}^{\infty} c\beta = +\infty.$$

This is a contradiction and therefore almost surely $\limsup |\Re(Y_n)| = +\infty$. \square

Lemma 51. *Let $\lambda > \lambda_c$ and consider the biased random walk RW_λ on $\mathcal{T}_{\mathbb{Z}^2}$ or $\mathcal{T}_{\mathbb{H}}$. Then $\#\{n > 0 : \Im(Y_n) = 0\} \geq 1$ almost surely.*

Proof. We again deal separately with two cases.

Case I: The tree $\mathcal{T}_{\mathbb{Z}^2}$. Assume that $\alpha := \mathbb{P}(\forall n > 0, \Im(Y_n) > 0) > 0$, hence

$$(6.5) \quad 0 < \mathbb{P}(\exists n > 0, \Im(Y_n) = 0) = 1 - \alpha < 1.$$

Given that the sequence $(\{\exists k \in (0, n] : \Im(Y_k) = 0\})_{n \geq 1}$ is an increasing sequence,

$$(6.6) \quad 1 - \alpha = \mathbb{P}(\exists n > 0 : \Im(Y_n) = 0) = \lim_n \mathbb{P}(\exists k \in (0, n] : \Im(Y_k) = 0).$$

Let $\varepsilon > 0$, by using 6.5, then there exist n_0 such that for all $n \geq n_0$,

$$(6.7) \quad \mathbb{P}(\exists k \in (0, n] : \Im(Y_k) = 0) \geq 1 - \alpha - \varepsilon.$$

We know that the biased random walk does not reach the line $\mathbb{Z} \times \{0\}$ with a probability $p > 0$. By Lemma 50, the random walk X_n must reach the domain $H := \{\Re(z) = n_0\} \cup \{\Re(z) = -n_0\}$ with a probability 1. We consider the first time S , that the random walk X_n reaches H and we assume that it reaches the line $\{\Re(z) = n_0\}$. We continue one step on the random walk to reach the line $\{\Re(z) = n_0 + 1\}$.

The key observation, which we will use several times in similar forms in what follows, is that the behavior of the walk after time S , and until its first

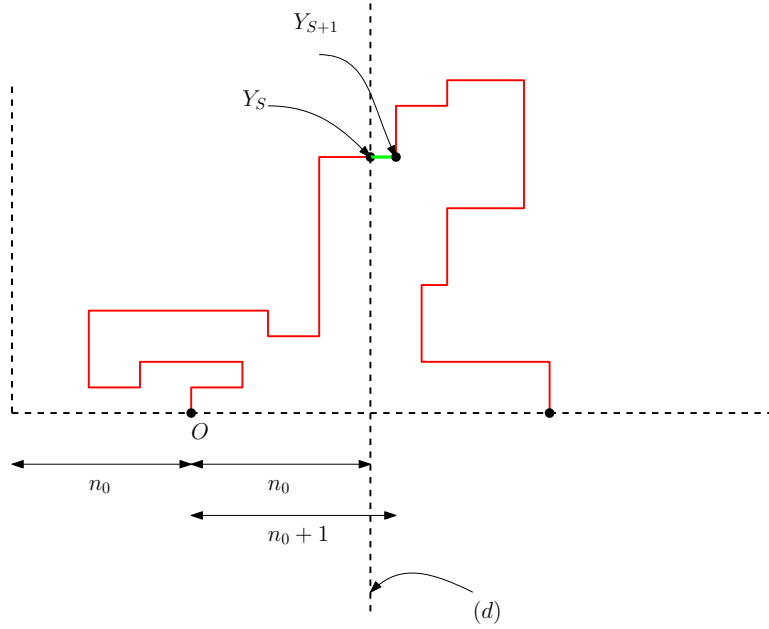

FIGURE 4. Illustration of the proof of Lemma 51

visit to the parent X_S^{-1} , matches the similar process defined in the domain $\mathbb{Z}^2 \setminus \{X_S(k) : 0 \leq k < |X_S|\}$. Here, this domain contains the half-plane

$$Y_S := \{(x, y) \in \mathbb{Z}^2 : x \geq \Re(Y_S)\}$$

and our running hypothesis implies that the random walk after the time S will stay in this half-plane with probability α (see Figure 4). As a shortcut, we will later refer to this kind of construction as *considering a new half-plane with origin Y_S* .

From the previous discussion,

$$(6.8) \quad \mathbb{P}(\forall k \leq n_0 : \Im(Y_k) > 0 \text{ and } \exists k > n_0 : \Im(Y_k) = 0) = \frac{\lambda\alpha^2}{1 + 3\lambda}.$$

Because the two events $\{\forall k \leq n_0 : \Im(Y_k) > 0 \text{ and } \exists k > n_0 : \Im(Y_k) = 0\}$ and $\{\exists k \in (0, n_0] : \Im(Y_k) = 0\}$ are disjoint and included in the event $\{\exists n > 0 : \Im(Y_n) = 0\}$, we use 6.7 and 6.8 to get

$$1 - \alpha = \mathbb{P}(\{\exists n > 0 : \Im(Y_n) = 0\}) \geq 1 - \alpha - \varepsilon + \frac{\lambda\alpha^2}{1 + 3\lambda}.$$

If we take small enough ε , then we obtain a contradiction.

Case II: The tree $\mathcal{T}_{\mathbb{H}}$. Now, we prove that $|\{n : \Im(Y_n) = 0\}| \geq 1$ a.s for the tree $\mathcal{T}_{\mathbb{H}}$. We set $\alpha = \mathbb{P}(\forall n > 0 : \Im(Y_n) > 0)$. Assume that $p > 0$, because the random walk in the domain $\{\Im(z) > 0\}$ of the half-plane has the same law

as the random walk in this domain of the plan. This implies that the random walk X_n on the plan does not reach the line $\mathbb{Z} \times \{0\}$ with a positive probability. This is a contradiction with step 1 and then $p = 0$. \square

6.3.2. The second step. The goal of this step is to prove the following lemma:

Lemma 52. *Let $\lambda > \lambda_c$ and consider the biased random walk RW_λ on $\mathcal{T}_{\mathbb{Z}^2}$ or $\mathcal{T}_{\mathbb{H}}$. Then almost surely $\#\{n > 0 : \mathfrak{S}(Y_n) = 0\} = +\infty$.*

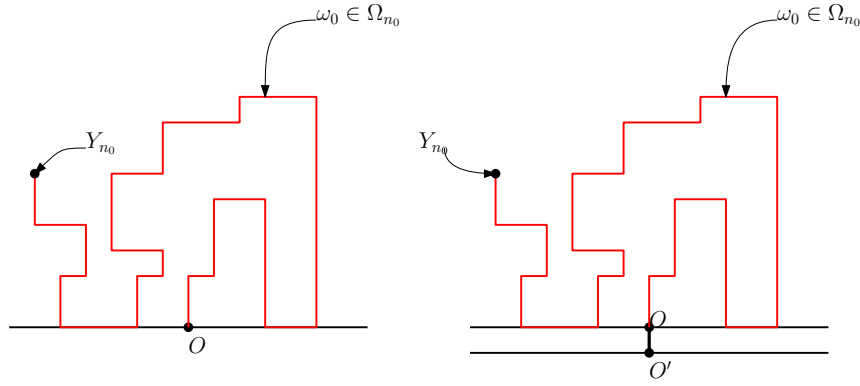

FIGURE 5. Illustration of the proof of Lemma 52, case $\mathcal{T}_{\mathbb{H}}$

Proof. We again need to deal separately with two cases.

Case I: the tree $\mathcal{T}_{\mathbb{H}}$. We denote by A the following event:

$$A := \{\#\{n > 0 : \mathfrak{S}Y_n = 0\} = \infty\}.$$

Or equivalently, $A = \{\forall k, \exists n > k : \mathfrak{S}Y_n = 0\}$. Assume that $\mathbb{P}(A) < 1$, we have then $\mathbb{P}(A^c) > 0$. Hence, there exists $n_0 > 0$ such that,

$$(6.9) \quad \mathbb{P}(\forall n > n_0 : \mathfrak{S}Y_n > 0) > 0.$$

Now, consider the random walk until time n_0 . Denote by Ω_{n_0} the set of all configurations $(Y_0, Y_1, \dots, Y_{n_0})$. For each $\omega \in \Omega_{n_0}$, we define the event A_ω as follows:

$$(6.10) \quad A_\omega := \{\text{for all } n > n_0, \text{ we have } \mathfrak{S}(Y_n) > 0 \text{ and } (Y_0, Y_1, \dots, Y_{n_0}) = \omega\}.$$

Hence,

$$(6.11) \quad \mathbb{P}(\forall n > n_0 : \mathfrak{S}Y_n > 0) = \sum_{\omega \in \Omega_{n_0}} \mathbb{P}(A_\omega) > 0.$$

Since the cardinal of Ω_{n_0} is finite, there exists $\omega_0 \in \Omega_{n_0}$ such that $\mathbb{P}(A_{\omega_0}) > 0$. We add a new line under the line $\mathbb{Z} \times \{0\}$ and consider a new half-plane \mathbb{H}' with origin O' (see the Figure 5 and the discussion in the proof of Lemma 51).

Observe the biased random walk X'_n with parameter λ on $\mathcal{T}_{\mathbb{H}'}$ and denote $Y'_n = p(X'_n)$. Conditioned on the events $\{Y_0 = O', Y'_1 = \omega_0(1), \dots, Y'_n(n_0) =$

$\omega_0(n_0)$ and A_{ω_0} , X and X' have the same law. This implies that the random walk X' on $\mathcal{T}_{\mathbb{H}'}$ does not reach the line $\mathbb{Z} \times \{0\}$ of \mathbb{H}' with a positive probability. This is a contradiction and then $\mathbb{P}(A) = 1$, which concludes the proof of Lemma 52 in the case $T_{\mathbb{H}}$.

Case II: the tree $\mathcal{T}_{\mathbb{Z}^2}$.

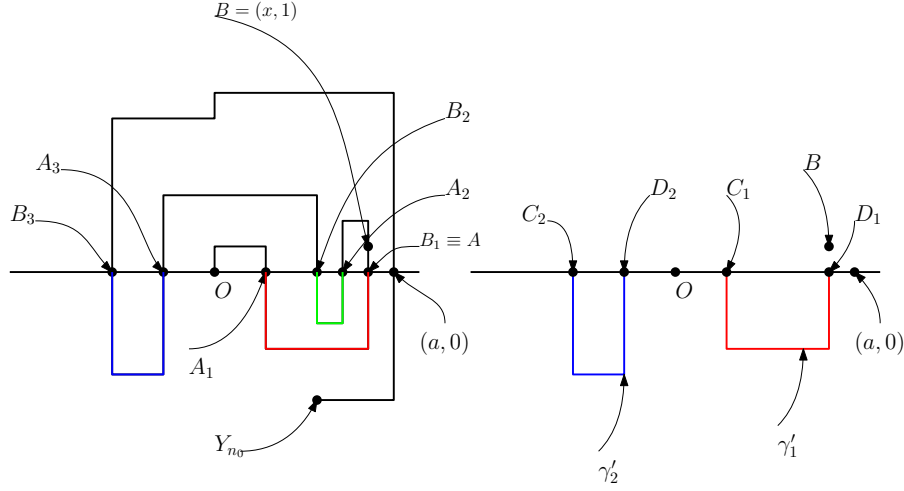

FIGURE 6. Illustration of the proof of Lemma 52, case $\mathcal{T}_{\mathbb{Z}^2}$

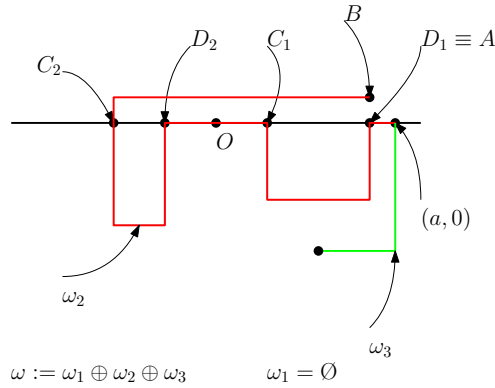

FIGURE 7. Illustration of the proof of Lemma 52, case $\mathcal{T}_{\mathbb{Z}^2}$

Assume that the random walk reaches the line $\mathbb{Z} \times \{0\}$ an infinite number of times with a probability strictly less than 1. By using the same argument as in the case $T_{\mathbb{H}}$, there exists a configuration ω_0 and a positive number n_0 such that $\mathbb{P}(A_{\omega_0}) > 0$ where A_{ω_0} is defined as in 6.10.

Let $A_1 = (a_1, 0), B_1 = (b_1, 0) \dots, A_k = (a_k, 0), B_k = (b_k, 0)$ be $2k$ points of intersections of the line $\mathbb{Z} \times \{0\}$ with ω along the curve ω such that for any

$1 \leq i \leq k$, there exists a self-avoiding walk γ_i in ω starting at $(a_i, 0)$ and ending at $(b_i, 0)$ which is below the line $\mathbb{Z} \times \{0\}$. Denote by $(a, 0)$ the last point of intersection of the line $\mathbb{Z} \times \{0\}$ with ω before that the random walk does not reach the line $\mathbb{Z} \times \{0\}$. Let $A := (x, 0)$ to be $(a_i, 0)$ or $(b_i, 0)$ which maximises the first coordinate and we set $B = (x, 1)$ (see Figure 6, on the left).

Consider a new plane \mathbb{Z}^2 with an origin at B and consider the random walk RW_λ on the tree $\mathcal{T}_{\mathbb{H}}$ starting at B . Let $\Gamma = (\gamma_1, \gamma_2, \dots, \gamma_k)$ be a set of k self-avoiding walks in ω which connect $(a_i, 0)$ to $(b_i, 0)$. If there exist i, j such that $[a_j \wedge b_j, a_j \vee b_j] \subset [a_i \wedge b_i, a_i \vee b_i]$, then we remove the self-avoiding walk γ_j from Γ . Finally, we obtain a subset $\Gamma' = (\gamma'_1, \gamma'_2, \dots, \gamma'_m)$ of Γ in which there are no i, j such that $[a_j \wedge b_j, a_j \vee b_j] \subset [a_i \wedge b_i, a_i \vee b_i]$. We can assume that γ'_i connect $C_i = (c_i, 0)$ to $D_i = (d_i, 0)$ and for all $i \in \{1, \dots, m\}$, we have $c_1 > c_2 > \dots > c_m$ and $c_i < d_i$ (see Figure 6, on the right).

Define a self-avoiding walk ω starting at B as follows (see the Figure 7):

Set $u = \sup \{1 \leq i \leq m : c_i > a\}$ and define the three following self-avoiding walks:

$$\begin{cases} \omega_1 := [BA] \oplus \gamma_1 \oplus [(d_2, 0), (c_1, 0)] \oplus \gamma_2 \oplus [(d_3, 0), (c_2, 0)] \oplus \dots \oplus \gamma_u \oplus [(c_u, 0), (c_u, 1)] \\ \omega_2 := [(c_u, 1), (c_m, 1)] \oplus [(c_m, 1), (c_m, 0)] \oplus \gamma_m \oplus [(d_m, 0), (c_{m-1}, 0)] \dots \oplus \gamma_{u+1}, [(d_{u+1}, 0), (a, 0)] \\ \omega_3 := \omega|_{[t, n_0]} \text{ where } \omega(t) = (a, 0), \end{cases}$$

and we define $\omega := \omega_1 \oplus \omega_2 \oplus \omega_3$.

Consider the biased random walk X_n with parameter λ on $\mathcal{T}_{\mathbb{H}}$, where \mathbb{H} is the half-plane with the origin B . Recall that $Y_n = p(X_n)$. Note that, conditioned to the event $\{(Y_0, \dots, Y_{|\omega|}) = \omega\}$, with a positive probability, the random walk reach a finite number of times the half-plane \mathbb{H} . This is a contradiction with the case $\mathcal{T}_{\mathbb{H}}$ above. \square

Remark 53. *All of results that we proved in the first step and second step for $\mathcal{T}_{\mathbb{Z}^2}$ and $\mathcal{T}_{\mathbb{H}}$, are still valid for $\tilde{\mathcal{T}}_{\mathbb{H}}$ and $\tilde{\mathcal{T}}_{\mathbb{Z}^2}$. Note that it is sufficient to prove the theorem 2 in the case $\tilde{\mathcal{T}}_{\mathbb{H}}$ and $\tilde{\mathcal{T}}_{\mathbb{Z}^2}$, which means the biased random walk on $\tilde{\mathcal{T}}_{\mathbb{H}}$ and $\tilde{\mathcal{T}}_{\mathbb{Z}^2}$ almost surely reaches the line $\mathbb{Z} \times \{0\}$ an infinite number of times).*

6.3.3. The third step. In this step, we give a proof of Theorem 2 in the case $\mathbb{P}_\lambda^{\mathbb{Z}^2}$. We start with the following definition

Definition 54. *Let C be a closed, simple curve of \mathbb{Z}^2 . The interior of C , denoted by $I(C)$ is a sub-domain of \mathbb{R}^2 which is surrounded by C (see Figure 8). Where $S(C)$ denotes the area of this domain. The exterior of C is defined by*

$$E(C) := \mathbb{R}^2 \setminus I(C).$$

Lemma 55. *Let $((a_1, 0), (a_2, 0), \dots, (a_{2n}, 0))$ be a sequence of points on the line $\mathbb{Z} \times \{0\}$ such that $a_1 < a_2 < \dots < a_{2n}$. For each i , we denote γ_i as the self-avoiding walk starting at $(a_{2i-1}, 0)$ and ending at $(a_{2i}, 0)$ which is below the line*

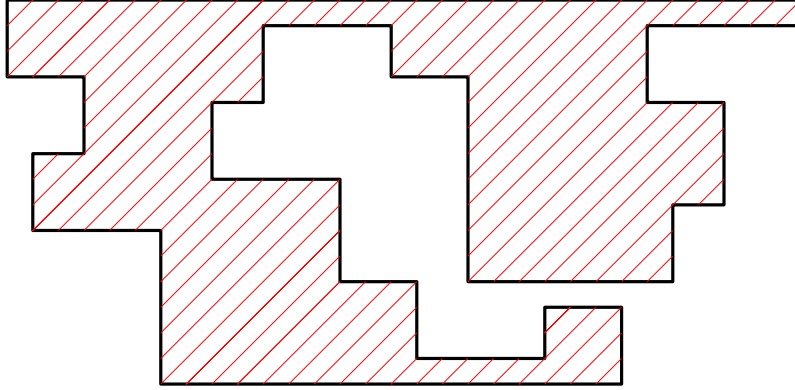

FIGURE 8. A closed, simple curve C of \mathbb{Z}^2 with its interior in red

$\mathbb{Z} \times \{0\}$. Suppose that for any i , we have

$$\gamma_i \cap \gamma_j = \emptyset.$$

We set $A := \bigcup \gamma_i$ and $B = \partial A \cup ((\bigcup_{i=1}^n [a_{2i-1}, a_{2i}] \times \{0\}))$ where,

$$\partial A := \left\{ z \in \mathbb{Z}^2 : \exists x \in A, 0 < d(x, z) \leq \sqrt{2} \right\} \text{ and } d \text{ is euclidean distance.}$$

Then there exists a self-avoiding walk in B starting at $(a_1 - 1, 0)$ and ending at $(a_{2n} + 1, 0)$.

Proof. The statement is intuitively clear. The proof is a simple but tedious issue of book-keeping, and is omitted here. \square

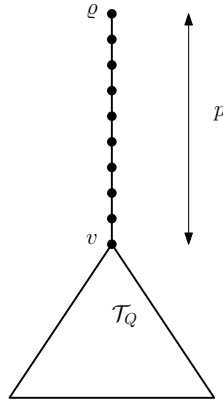

FIGURE 9. The tree \mathcal{T}

Proof of Theorem 2 in the case of $\mathbb{P}_\lambda^{\mathbb{Z}^2}$. We denote by A the following event:

$$A := \{ \# \{ n > 0 : \mathfrak{S}\omega_\lambda^\infty(n) = 0 \} = \infty \}.$$

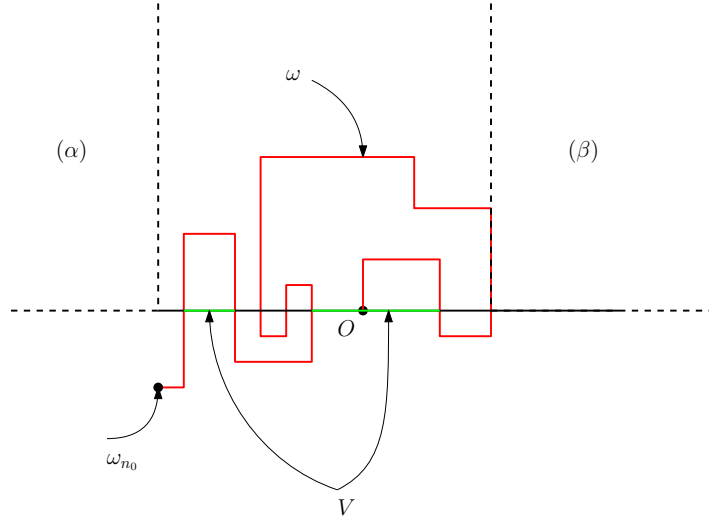

FIGURE 10. The self-avoiding walk ω is colored by red; the domain D is the union of two quadrants α and β and the set V is colored by green.

Assume that $\mathbb{P}(A) < 1$, by using the same argument as in the second step, there exist $n_0 > 0$ and a self-avoiding walk $\omega := [\omega(0), \omega(1), \dots, \omega(n_0)]$ starting at 0 such that the following event has a strictly positive probability (see Figure 10):

$$B := \left\{ \begin{array}{l} \omega_\lambda^\infty(0) = \omega(0), \omega_\lambda^\infty(1) = \omega(1), \dots, \omega_\lambda^\infty(n_0) = \omega(n_0) \\ \forall n > n_0 : \Im \omega_\lambda^\infty(n) < 0 \end{array} \right.$$

Define

$$D := \left\{ (x, y) \in \mathbb{Z}^2 : y \geq 0 \text{ and } x \notin \{\Re \omega_\lambda^\infty(i) : 0 \leq i \leq n_0\} \right\}.$$

and let V be a subset of $\mathbb{Z} \setminus D$ such that for all $x \in V$, there exists an infinite self-avoiding walk in half-plane $\{\Im z \leq 0\}$, starting at x and it does not reach the self-avoiding walk ω (see Figure 10).

For each $x \in V$, we denote by Γ_x the set of self-avoiding walks starting at x , which does not reach the path $(\omega(0), \dots, \omega(n_0))$, and reaches the domain D at only one point and such that, for each $z \in \gamma_x$, z belongs to the line $\mathbb{Z} \times \{0\}$ or z belongs to the boundary of self-avoiding walk $(\omega(0), \omega(1), \dots, \omega(n_0))$. By Lemma 55, Γ_x is not empty. We then set $p := \sup_{x \in V} \sup_{\gamma \in \Gamma_x} |\gamma|$.

Let \mathcal{T} be an infinite, locally finite and rooted tree defined by (see Figure 9):

$$\left\{ \begin{array}{l} |\mathcal{T}_i| = 1 \text{ for all } i \leq p \\ \mathcal{T}_p = \{v\} \\ \mathcal{T}^v = \mathcal{T}_\mathbb{Q} \end{array} \right.$$

We apply Lemma 52. Almost surely, the random walk reaches the line $\mathbb{Z} \times \{0\}$ an infinite number of times and, thus, it almost surely reaches the line $\mathbb{Z} \times \{0\}$ at least k times. Every time it reaches the line $\mathbb{Z} \times \{0\}$ at a point x , we can go on the random walk at most p steps to reach the domain D (we can do this because $TS L_{\mathbb{Z}^2}$ have no leaf and then x belongs to V). Then, the limit walk stays within the half-plane $\{\Im z < 0\}$ after the step n_0 with a probability smaller than $(1 - \mathcal{C}(\lambda, \mathcal{T}))$, where $\mathcal{C}(\lambda, \mathcal{T})$ is the effective conductance for the network (\mathcal{T}, c) with $c(e) = \lambda^{|e|}$. Hence, for any $k > 0$, we have

$$\mathbb{P}(B) \leq (1 - \mathcal{C}(\lambda, \mathcal{T}))^k$$

Because we have $\mathcal{C}(\lambda, \mathcal{T}) > 0$ (and because it contains the tree $\mathcal{T}_{\mathbb{Q}}$), then $\mathbb{P}(B) = 0$. This is a contradiction and implies Theorem 2 in the case \mathbb{Q}_λ -measure. \square

6.3.4. The last step. In this section, we give a proof of Theorem 2 in the case $\mathbb{P}_\lambda^{\mathbb{H}}$.

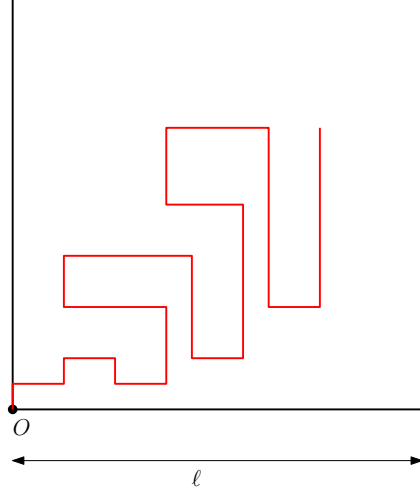

FIGURE 11. A bridge of a strip B_ℓ

Notation 56. A strip B_ℓ of size ℓ is a sub-domain of \mathbb{Z}^2 , which is limited by two lines $\{\Im z = a\}$ and $\{\Im z = b\}$ (or $\{\Re z = a\}$ and $\{\Re z = b\}$) such that $|a - b| = \ell$. Fix an origin $O \in \{\Im z = a\} \cup \{\Im z = b\}$ (or $\{\Re z = a\} \cup \{\Re z = b\}$) of B_ℓ . Let γ be a finite self-avoiding walk starting at O . We say that γ is a self-avoiding walk of the strip B_ℓ if for any $0 \leq k \leq |\gamma|$, we have $\gamma(k) \in B_\ell$. We define the self-avoiding tree \mathcal{T}_{B_ℓ} from the self-avoiding walks starting at O as in Notation 44.

Consider a strip B_ℓ . We define the bridge (resp. irreducible bridge) of B_ℓ in the same way as the definition of bridge (resp. irreducible bridge) in half-plane. (see Figure 11).

Lemma 57 (The subadditivity property). *Let ℓ, n be two positive natural numbers, denote by $p_n^{(\ell)}$ the number of bridges of length n starting at origin of the strip B_ℓ . For any $\ell, n, m, k \in \mathbb{N}^*$,*

$$p_{n+m}^{(2\ell)} \geq p_m^{(\ell)} p_n^{(\ell)} \quad \text{and} \quad p_{kn}^{(2\ell)} \geq (p_n^{(\ell)})^k.$$

Proof. Divide the strip $B_{2\ell}$ into two small strip $B_{2\ell}^1, B_{2\ell}^2$ of size ℓ (see Figure 12). For any $z \in \mathbb{Z}^2$, denote by $L(z)$ the line goes through z and orthogonal to $\mathbb{Z} \times \{0\}$. Denote by S_z the orthogonal symmetry with respect to $L(z)$.

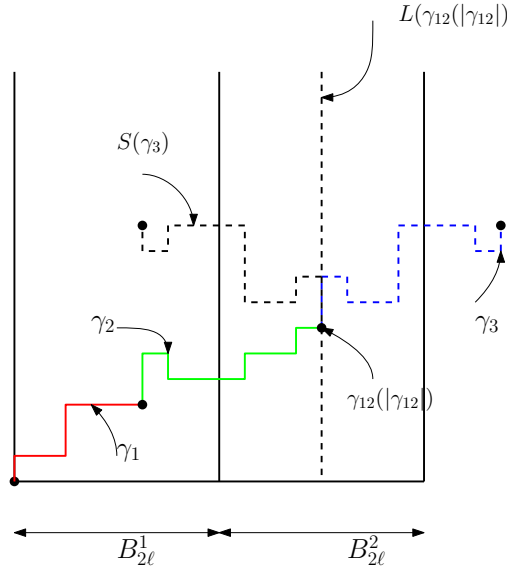

FIGURE 12. A concatenation of 3 bridges in $B_{2\ell}^1$.

Consider γ_1, γ_2 two bridges of the strip $B_{2\ell}^1$ of length m and n , we concatenate γ_1 and γ_2 to obtain a new bridge $\gamma_{12} := \gamma_1 \oplus \gamma_2$ of length $m + n$ of the strip $B_{2\ell}$ (see Figure 12). Hence, for any $\ell, n, m \in \mathbb{N}^*$,

$$p_{n+m}^{(2\ell)} \geq p_m^{(\ell)} p_n^{(\ell)}.$$

If one takes the third bridge γ_3 of $B_{2\ell}^1$ of length t , we concatenate γ_{12} and γ_3 as follows (see Figure 12):

$$\begin{cases} \gamma_{123} = \gamma_{12} \oplus \gamma_3 & \text{if } \gamma_{12}(|\gamma_{12}|) \in B_{2\ell}^1 \\ \gamma_{123} = \gamma_{12} \oplus S_{\gamma_{12}(|\gamma_{12}|)}(\gamma_3) & \text{if } \gamma_{12}(|\gamma_{12}|) \in B_{2\ell}^2 \end{cases}$$

Note that γ_{123} is a bridge of length $m + n + p$ of the strip $B_{2\ell}$. Hence, for any $\ell, n, m, t \in \mathbb{N}^*$,

$$p_{n+m+t}^{(2\ell)} \geq p_m^{(\ell)} p_n^{(\ell)} p_t^{(\ell)}.$$

By repeating the same strategy, we obtain the result of Lemma 57. \square

Lemma 58. *Denote by $\mu(\ell)$ the connective constant of the strip B_ℓ . Then we have,*

$$\lim_{\ell \rightarrow \infty} \mu(\ell) = \mu,$$

where μ is the connective constant of \mathbb{Z}^2 .

Proof. Denote by $b_n^{\mathbb{Q}}$ the number of bridges of length n of \mathbb{Q} , starting at origin. Note that for any ℓ , we have:

$$(6.12) \quad \lim_{n \rightarrow \infty} (p_n^{(\ell)})^{\frac{1}{n}} = \mu(\ell) \text{ and } p_\ell^{(\ell)} = b_\ell^{\mathbb{Q}}.$$

Moreover, we also have:

$$(6.13) \quad \lim_{n \rightarrow \infty} (b_n^{\mathbb{Q}})^{\frac{1}{n}} = \mu.$$

By using Lemma 57, for any ℓ, n, k :

$$(6.14) \quad p_{kn}^{(2\ell)} \geq (p_n^{(\ell)})^k.$$

Fix $\varepsilon > 0$ and by 6.13, there exists n_0 such that for any $n > n_0$, we have

$$(6.15) \quad \left| (b_n^{\mathbb{Q}})^{\frac{1}{n}} - \mu \right| \leq \varepsilon.$$

Let $\ell > n_0$ and $k > 0$. By 6.12, 6.14 and 6.15, we have:

$$(6.16) \quad (p_{k\ell}^{(2\ell)})^{\frac{1}{k\ell}} \geq (p_\ell^{(\ell)})^{\frac{1}{\ell}} = (b_\ell^{\mathbb{Q}})^{\frac{1}{\ell}} \geq \mu - \varepsilon.$$

Since the sequence $(p_{k\ell}^{(2\ell)})^{\frac{1}{k\ell}}$ converges towards $\mu(2\ell)$ when k goes to infinity, we use 6.16 to obtain:

$$(6.17) \quad \mu \geq \mu_{2\ell} \geq \mu - \varepsilon,$$

where inequality $\mu \geq \mu_{2\ell}$ is obvious. Hence, the sequence $(\mu(\ell), \ell \geq 1)$ converges towards μ when ℓ goes to $+\infty$. \square

Proposition 59. *Denote by $br(\mathcal{T}_{B_\ell})$ the branching number of \mathcal{T}_{B_ℓ} . Then we have,*

$$\lim_{\ell \rightarrow \infty} br(\mathcal{T}_{B_\ell}) = \mu,$$

where μ is the connective constant of \mathbb{Z}^2 .

Proof. Recall the definition of A_m in the proof of Proposition 47:

$$A_m := \{\omega \in iSAB, |\omega| \leq m\},$$

where $iSAB$ is the set of irreducible-bridges in half-plane \mathbb{H} . Let γ be an infinite self-avoiding walk starting at origin of B_ℓ , it is called " m -nice walk" if it possesses a decomposition into irreducible bridges in A_m . Denote by $G_m(B_\ell)$ the set of infinite self-avoiding walk of B_ℓ which are " m -nice". Let $\mathcal{T}_{B_\ell}^{(m)}$ be a sub-tree of \mathcal{T}_{B_ℓ} , which we will refer to as the m -nice tree, defined by $E(\mathcal{T}_{B_\ell}^{(m)}) := E(\mathcal{T}_{B_\ell})|_{V(\mathcal{T}_{B_\ell}^{(m)}) \times V(\mathcal{T}_{B_\ell}^{(m)})}$ where,

$$V(\mathcal{T}_{B_\ell}^{(m)}) := \{\omega \in V(\mathcal{T}_{B_\ell}) : \text{there exists } \gamma \in G_m(B_\ell) \text{ such that } \gamma|_{[0,|\omega|]} = \omega\}.$$

Denote by $p_n^{(\ell, m)}$ be the number of bridges starting at origin of B_ℓ , of length n which possess a decomposition in A_m . Recall that $p_n^{(\ell)}$ is the number of bridges of length n starting at origin of the strip B_ℓ and $(\mathcal{T}_{B_\ell}^{(m)})_n$ is the number of vertices of $\mathcal{T}_{B_\ell}^{(m)}$ at generation n . Then for any $n > 0$, we have

$$(6.18) \quad \left| (\mathcal{T}_{B_\ell}^{(m)})_n \right| \geq p_n^{(m)}.$$

By using Lemma 57, for any ℓ, m, n, k we have:

$$(6.19) \quad p_{nk}^{(2\ell)} \geq (p_n^{(\ell)})^k \text{ and } p_{nk}^{(2\ell, m)} \geq (p_n^{(\ell, m)})^k.$$

As we know (see paragraph 46) all bridges in a half-plane can be decomposed into a sequence of irreducible bridges in a unique. Therefore each bridge in B_ℓ of length m possesses a decomposition into irreducible bridges in A_m . Hence, for any $m, \ell > 0$,

$$(6.20) \quad p_m^{(\ell)} = p_m^{(\ell, m)}.$$

Fix $\varepsilon > 0$, by Lemma 58, there exists ℓ_0 such that for any $\ell > \ell_0$,

$$(6.21) \quad \mu \geq \mu(2\ell) > \mu - \varepsilon.$$

Moreover, since $\mu(2\ell) = \lim_{n \rightarrow \infty} (p_n^{(2\ell)})^{\frac{1}{n}}$, then there exists n_0 such that for any $n > n_0$:

$$(6.22) \quad (p_n^{(2\ell)})^{\frac{1}{n}} > \mu(2\ell) - \varepsilon.$$

Hence by 6.20, 6.19, 6.21 and 6.22,

$$(6.23) \quad (p_{kn}^{(4\ell, n)})^{\frac{1}{kn}} \geq (p_n^{(2\ell, n)})^{\frac{1}{n}} = (p_n^{(2\ell)})^{\frac{1}{n}} \geq \mu(2\ell) - \varepsilon \geq \mu - 2\varepsilon.$$

Therefore for $\ell > \ell_0$ and $n > n_0(\ell)$ (i.e n_0 depends on ℓ), we have

$$(6.24) \quad \overline{gr(\mathcal{T}_{B_{4\ell}}^n)} \geq \mu - 2\varepsilon.$$

On the other hand, note that $T_{B_{4\ell}}^n$ is $(n + 4\ell)$ -super-periodic and $\overline{gr(\mathcal{T}_{B_{4\ell}}^n)} < +\infty$, we use Theorem 12 to get:

$$(6.25) \quad gr(\mathcal{T}_{B_{4\ell}}^n) \text{ exists and } gr(\mathcal{T}_{B_{4\ell}}^n) = br(\mathcal{T}_{B_{4\ell}}^n).$$

Since $\mathcal{T}_{B_{4\ell}}^n \subset \mathcal{T}_{B_{4\ell}}$, by using 6.24, 6.25 and Proposition 8 we obtain for any $\ell > \ell_0$:

$$(6.26) \quad \mu \geq br(\mathcal{T}_{B_{4\ell}}) \geq \mu - 2\varepsilon,$$

where we used $\mathcal{T}_{B_{4\ell}} \subset \mathcal{T}_{\mathbb{H}}$ for the first inequality. Therefore, the sequence $(br(\mathcal{T}_{B_{4\ell}}))_{\ell \geq 1}$ converges towards μ when ℓ goes to infinity. \square

Proposition 60. *We consider the biased random walk RW_λ on $\tilde{\mathcal{T}}_{\mathbb{H}}$. Let $(B_\ell)_{\ell \geq 1}$ be the sequence of strips of \mathbb{H} where B_ℓ is the strip between two lines $\Im z = 0$ and $\Im z = n$. Suppose that $\lambda > \frac{1}{\mu}$, where μ is the connective constant of \mathbb{H} . Then, there exists $\ell > 0$ such that the limit walk ω_λ^∞ almost surely touches the strip B_ℓ an infinite number of times.*

Proof. We fix $\lambda > \frac{1}{\mu}$. Assume that, for all $\ell > 0$, the limit walk reaches the strip B_ℓ a finite number of times with a strictly positive probability. By Proposition 59, there exists ℓ_0 such that $\lambda > \frac{1}{br(\mathcal{T}_{B_{\ell_0}})}$. We use again the same argument as in the second step, there then exists $n_0 > 0$ and a self-avoiding walk $\omega = [\omega(0), \omega(1), \dots, \omega(n_0)]$ such that the following event has a strictly positive probability:

$$B := \begin{cases} \omega_\lambda^\infty(0) = \omega(0), \omega_\lambda^\infty(1) = \omega(1), \dots, \omega_\lambda^\infty(n_0) = \omega(n_0) \\ \forall n > n_0 : \Im \omega_\lambda^\infty(n) > \ell_0 \end{cases}$$

By Lemma 52, we know that the random walk almost surely reaches the line $\mathbb{Z} \times \{0\}$ an infinite number of times and then it must reach the line $\{\Im z = \ell_0\}$ an infinite number of times almost surely. By using the same argument as in the third step, for any $k > 0$, we have:

$$\mathbb{P}(B) \leq (1 - \mathcal{C}(\lambda, \mathcal{T}_{B_{\ell_0}}))^k.$$

Because we have $\mathcal{C}(\lambda, \mathcal{T}_{B_{\ell_0}}) > 0$ (and because we have taken $\lambda > \lambda_c(\mathcal{T}_{B_{\ell_0}})$), then $\mathbb{P}(B) = 0$. This is a contradiction. We conclude that there exists $\ell > 0$ such that the limit walk on the tree $\tilde{\mathcal{T}}_{\mathbb{H}}$ almost surely reaches the strip B_ℓ . \square

Proof of Theorem 2 in the case of $\mathbb{P}_\lambda^{\mathbb{H}}$. By Proposition 60, we can fix a number ℓ such that the limit walk almost surely reaches the domain B_ℓ an infinite number of times. Now, we prove that the limit walk almost surely reaches an infinite number of times the line $\mathbb{Z} \times \{0\}$.

Assume that $\mathbb{P}(\#\{n : \Im \omega^\infty(n) = 0\} < +\infty) > 0$, then there exist n_0 and a self-avoiding walk ω of length n_0 starting at origin such that the following

event occurs with a strictly positive probability:

$$C := \begin{cases} \omega_\lambda^\infty(0) = \omega(0); \omega_\lambda^\infty(1) = \omega(1); \dots; \omega_\lambda^\infty(n_0) = \omega(n_0) \\ \forall n > n_0 : \mathfrak{S}\omega_\lambda^\infty(n) > 0 \end{cases}$$

Let \mathcal{T}^* be a tree defined by

$$\begin{cases} |\mathcal{T}_i^*| = 1 \text{ for all } t \leq \ell \\ \mathcal{T}_\ell^* = \{v\} \\ (\mathcal{T}^*)^v = \mathcal{T}_{B_\ell} \end{cases}$$

Recall that $Y_n := p(X_n)$. Let U be a set of naturals n such that: $\Re Y_n = \sup_{0 \leq i \leq n; Y_i \in B_\ell} \Re Y_i$ or $\Re Y_n = \inf_{0 \leq i \leq n; Y_i \in B_\ell} \Re Y_i$. For each $n \in U$, we go on the walk in the vertical direction until it reaches the line $\mathbb{Z} \times \{0\}$. When it reaches the line $\mathbb{Z} \times \{0\}$, it remains in reach of the line $\mathbb{Z} \times \{0\}$ with a probability that is greater than $c \times \mathcal{C}(\lambda, \mathcal{T}^*)$ where c is a constant that does not depend on n .

Because the walk almost surely touches the line $\mathbb{Z} \times \{0\}$ an infinite number of times, we then have $|U| = +\infty, p.s.$ This implies that $\mathbb{P}(C) = 0$. This is a contradiction. \square

6.4. The law of first k -steps of limit walk. We consider the biased random walk RW_λ on $\mathcal{T}_\mathbb{H}$. Recall that ω_λ^∞ is the associated limit walk and $\mathbb{P}_\lambda^\mathbb{H}$ denotes its law.

Let $k \in \mathbb{N}^*$ and y_1, y_2, \dots, y_k be k elements of $V(\mathcal{T}_\mathbb{H})$ such that $(o, y_1, y_2, \dots, y_k)$ is a simple path starting at o of $\mathcal{T}_\mathbb{H}$. For each $\lambda > \lambda_c$, recall that the law of first k -steps is defined by:

$$(6.27) \quad \varphi^{\lambda, k}(y_1, y_2, \dots, y_k) = \mathbb{P}_\lambda^\mathbb{H}(\omega_\lambda^\infty(1) = y_1, \omega_\lambda^\infty(2) = y_2, \dots, \omega_\lambda^\infty(k) = y_k).$$

We prove the continuity of this function.

Theorem 61. *For every $k \in \mathbb{N}^*$ and $(y_1, y_2, \dots, y_k) \in V^k$, the function $\varphi^{\lambda, k}$ is a continuous function of λ on $(\lambda_c, +\infty)$.*

Let \mathcal{T} be an infinite, locally finite and rooted tree and ν is a child of the root. Recall the definition of $\tilde{\mathcal{C}}(\lambda, \mathcal{T})$ and $\tilde{\mathcal{C}}(\lambda, \mathcal{T}, \nu)$ in Section 2.3. To prove the theorem 61, we need the following lemma:

Lemma 62. *We have*

$$\varphi^{\lambda, k}(y_1, y_2, \dots, y_k) = \frac{\tilde{\mathcal{C}}(\lambda, \mathcal{T}, y_1)}{\tilde{\mathcal{C}}(\lambda, \mathcal{T})} \times \frac{\tilde{\mathcal{C}}(\lambda, \mathcal{T}^{y_1}, y_2)}{\tilde{\mathcal{C}}(\lambda, \mathcal{T}^{y_1})} \times \dots \times \frac{\tilde{\mathcal{C}}(\lambda, \mathcal{T}^{y_{k-1}}, y_k)}{\tilde{\mathcal{C}}(\lambda, \mathcal{T}^{y_{k-1}})}.$$

Proof. We prove this lemma in the case $k = 1$, and leave the (slightly more complicated, but following the same lines) cases $k \geq 2$ to the reader.

The case $k = 1$ We let $\tilde{\mathcal{C}}_i(\lambda, \mathcal{T})$ denote the probability return to origin k times before going to infinite for the biased random walk on the tree \mathcal{T} . We

define the events $\mathcal{A} := \{\omega_\lambda^\infty(1) = y_1\}$ and \mathcal{A}_i denote the random walk return to origin k times before it goes to infinity by passing through y_1 . In other words,

$$\mathcal{A}_i := \{\omega_\lambda^\infty(1) = y_1 \text{ and } \#\{n > 0 : X_n = o\} = k\}.$$

The events \mathcal{A}_i are disjoint, we can then see that

$$(6.28) \quad \mathcal{A} = \bigcup_{i=0}^{+\infty} \mathcal{A}_i.$$

On the other hand, by the Markov property, for any $i \geq 0$, we have

$$(6.29) \quad \mathbb{P}(\mathcal{A}_i) = \tilde{\mathcal{C}}(\lambda, \mathcal{T}, y_1) \left(1 - \tilde{\mathcal{C}}(\lambda, \mathcal{T})\right)^i.$$

By 6.28 and 6.29, we obtain:

$$\mathbb{P}(\mathcal{A}) = \sum_{i=0}^{+\infty} \mathbb{P}(\mathcal{A}_i) = \frac{\tilde{\mathcal{C}}(\lambda, \mathcal{T}, y_1)}{\tilde{\mathcal{C}}(\lambda, \mathcal{T})}.$$

Therefore, $\varphi^{\lambda,1}(y_1) = \mathbb{P}(\mathcal{A}) = \frac{\tilde{\mathcal{C}}(\lambda, \mathcal{T}, y_1)}{\tilde{\mathcal{C}}(\lambda, \mathcal{T})}$. \square

Proof of Theorem 61. By Lemma 62, we have

$$\varphi^{\lambda,k}(y_1, y_2, \dots, y_k) = \frac{\tilde{\mathcal{C}}(\lambda, \mathcal{T}, y_1)}{\tilde{\mathcal{C}}(\lambda, \mathcal{T})} \times \frac{\tilde{\mathcal{C}}(\lambda, \mathcal{T}^{y_1}, y_2)}{\tilde{\mathcal{C}}(\lambda, \mathcal{T}^{y_1})} \times \dots \times \frac{\tilde{\mathcal{C}}(\lambda, \mathcal{T}^{y_{k-1}}, y_k)}{\tilde{\mathcal{C}}(\lambda, \mathcal{T}^{y_{k-1}})}.$$

It is enough to prove that $\tilde{\mathcal{C}}(\lambda, \mathcal{T}^{y_i}, y_{i+1})$ and $\tilde{\mathcal{C}}(\lambda, \mathcal{T}^{y_i})$ are continuous. For the continuity of $\tilde{\mathcal{C}}(\lambda, \mathcal{T}^{y_i})$, we use the same method as in the proof of theorem 3 (see Section 5.4). For the continuity of $\tilde{\mathcal{C}}(\lambda, \mathcal{T}^{y_i}, y_{i+1})$, this function can be written in terms of λ and $\tilde{\mathcal{C}}(\lambda, \mathcal{T}^{y_i})$. \square

Remark 63. *Theorem 61 is still valid in the case $\mathcal{T}_{\mathbb{Z}^2}$.*

7. THE CRITICAL PROBABILITY MEASURE THROUGH BIASED RANDOM WALK

7.1. The critical probability measure. In this section, \mathbb{H} is the upper-half plane (i.e $\mathbb{H} = \{\Im z > 0\} \cup \{(0, 0)\}$) and consider the self-avoiding tree $\mathcal{T}_{\mathbb{H}}$ which is defined from finite self-avoiding walks on upper-half plane \mathbb{H} (see Figure 13). Note that the root o of $\mathcal{T}_{\mathbb{H}}$ has only one child, denoted by y .

We aim to construct a critical probability measure through the biased random walk on self-avoiding tree. First, we review the construction of Madras and Slade (see [16] for detail). Recall that b_n is the number of all n -step bridges that begin at O and \mathcal{B}_n denote the set of all n -step bridges that begin at O .

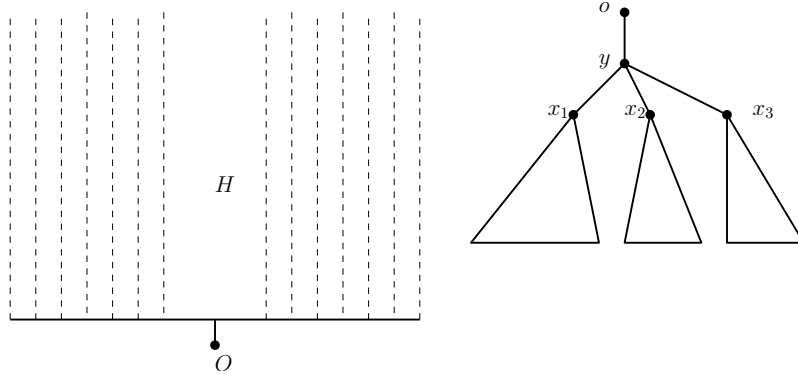

FIGURE 13. The upper-half plane on the left and the tree $\mathcal{T}_{\mathbb{H}}$ on the right.

Given $n \geq m$ and an m -step self-avoiding walk γ in \mathbb{H} . Let $\mathbb{P}_{m,n}^{\mathcal{B}}(\gamma)$ denote the fraction of n -step bridges that extend γ , it means

$$(7.1) \quad \mathbb{P}_{m,n}^{\mathcal{B}}(\gamma) = \frac{|F_n(\gamma) \cap \mathcal{B}_n|}{b_n} = \frac{|\mathcal{F}_n(\gamma)|}{b_n},$$

where $\mathcal{F}_n(\gamma)$ is the set of all n -step bridges which extend γ . The equality (7.1) is the probability that a long bridge (uniformly chosen from among all n -step bridges) is an extension of γ . Define

$$(7.2) \quad \mathbb{P}_m^{\mathcal{B}}(\omega) := \lim_{n \rightarrow \infty} \mathbb{P}_{m,n}^{\mathcal{B}}(\gamma).$$

Fact 64 ([16], Theorem 8.3.1). *Let γ be an m -step self-avoiding walk in \mathbb{H} . Then the limit (7.2) exists.*

The existence of the measures $\mathbb{P}_m^{\mathcal{B}}$ allows us to define a measure $\mathbb{P}_{\infty}^{\mathcal{B}}$ on the set SAW_{∞} of \mathbb{H} . For each $\gamma^{\infty} \in SAW_{\infty}$, $\gamma^{\infty} [0, m]$ denote the initial segment $(\gamma^{\infty}(0), \gamma^{\infty}(1), \dots, \gamma^{\infty}(m))$, then

$$\mathbb{P}_{\infty}^{\mathcal{B}}(\gamma^{\infty} [0, m] = \gamma) = \mathbb{P}_m^{\mathcal{B}}(\gamma), \text{ for every } \gamma.$$

Fact 65 ([16], Theorem 8.3.2). *$\mathbb{P}_{\infty}^{\mathcal{B}}$ is the $\frac{1}{\mu}$ -Kesten measure, where μ is the connective constant of the square lattice.*

Recall that for all $m \geq 1$, \mathcal{T}^m is the m -good tree (see Notation 46). Fix $k \geq 1$ and $y_0 = o, y_1 = y, y_2, \dots, y_k \in V(\mathcal{T}_{\mathbb{H}})$, the function $\varphi^{m,\lambda,k}(y_0, y_1, \dots, y_k)$ (respectively $\varphi^{\mathbb{H},\lambda,k}(y_0, y_1, \dots, y_k)$) denotes the law of first k -steps of RW_{λ} on \mathcal{T}^m (respectively $\mathcal{T}_{\mathbb{H}}$) (see 6.27). We write $\lambda_c (= \frac{1}{\mu})$ for the critical parameter of RW_{λ} on $\mathcal{T}_{\mathbb{H}}$.

Theorem 66. *We have*

- (1) *The function $\varphi^{m,\lambda,k}(y_0, y_1, \dots, y_k)$ converges towards a limit, denoted by $\varphi^{m,\lambda_m,k}(y_0, y_1, \dots, y_k)$ when λ decreases towards $\lambda_m = \lambda_c(T^m)$.*

- (2) The function $\varphi^{m, \lambda_m, k}(y_0, y_1, \dots, y_k)$ converges towards a limit, denoted by $\varphi^{\lambda_c, k}(y_0, y_1, \dots, y_k)$.
- (3) Moreover, we have the following diagram:

$$\begin{array}{ccc} \varphi^{m, \lambda, k}(y_0, y_1, \dots, y_k) & \xrightarrow[\lambda > \lambda_c(\mathcal{T}_{\mathbb{H}})]{m \rightarrow +\infty} & \varphi^{\mathbb{H}, \lambda, k}(y_0, y_1, \dots, y_k) \\ \lambda \rightarrow \lambda_c(\mathcal{T}^m) \downarrow & & \downarrow ? \\ \varphi^{m, \lambda_m, k}(y_0, y_1, \dots, y_k) & \xrightarrow{m \rightarrow +\infty} & \varphi^{\lambda_c, k}(y_0, y_1, \dots, y_k) \end{array}$$

Proof of points 1 and 2 of Theorem 66. It suffices to prove the theorem in the case $k = 2$ and we use the same method for all $k \geq 3$.

Proof of item 1: By using the same method as the proof of Proposition 30, for all $i \in \{1, 2, 3\}$, we have:

$$(7.3) \quad \lim_{\lambda \rightarrow \lambda_c(\mathcal{T}^m)} \varphi^{m, \lambda, 2}(o, y, x_i) = \sum_{\gamma \in S^i} \lambda_m^{|\gamma|},$$

where x_1, x_2, x_3 are three children of y and S^i is a set of all irreducible bridges which pass through x_i and $\lambda_c(\mathcal{T}^m) = \lambda_m$. Let $p_{i,n}$ be the number of irreducible bridges of length n which are pass through x_i . We use 7.3 to obtain:

$$(7.4) \quad \lim_{\lambda \rightarrow \lambda_c(\mathcal{T}^m)} \varphi^{m, \lambda, 2}(o, y, x_i) = \sum_{n=1}^m p_{i,n} \lambda_m^n.$$

Hence,

$$(7.5) \quad \varphi^{m, \lambda_m, 2}(o, y, x_i) = \sum_{n=1}^m p_{i,n} \lambda_m^n.$$

Moreover, for all m we have $\lambda_m \geq \lambda_c (= \lambda_c(\mathcal{T}_{\mathbb{H}}))$ because $\mathcal{T}^m \subset \mathcal{T}_{\mathbb{H}}$. Therefore,

$$(7.6) \quad \varphi^{m, \lambda_m, 2}(o, y, x_i) \geq \sum_{n=1}^m p_{i,n} \lambda_c^n.$$

Proof of item 2: We need to prove that $\varphi^{m, \lambda_m, 2}(o, y, x_i)$ converges to $\varphi^{\lambda_c, 2}(o, y, x_i)$ when m goes to infinity. Assume that there exists a subsequence $(m_k)_k$ such that for any $i \in \{1, 2, 3\}$, we have:

$$(7.7) \quad \lim_{k \rightarrow +\infty} \varphi^{m_k, \lambda_{m_k}, 2}(o, y, x_i) = \alpha_i.$$

Moreover, we assume that there exists $i \in \{1, 2, 3\}$ such that

$$(7.8) \quad \alpha_i > \sum_{n=1}^{+\infty} p_{i,n} \lambda_c^n.$$

For any $m > 0$, we have $\sum_{i=1}^3 \varphi^{m, \lambda_m, 2}(o, y, x_i)$, therefore,

$$(7.9) \quad \alpha_1 + \alpha_2 + \alpha_3 = 1.$$

By 7.6, for any $i \in \{1, 2, 3\}$, we have:

$$(7.10) \quad \alpha_i \geq \sum_{n=1}^{+\infty} p_{1,n} \lambda_c^n.$$

We use Fact 41 to obtain

$$(7.11) \quad \sum_{i=1}^3 \sum_{n=1}^{+\infty} p_{i,n} \lambda_c^n = 1.$$

By 7.8, 7.9, 7.10 and 7.11, we obtain the following contradiction:

$$1 = \alpha_1 + \alpha_2 + \alpha_3 > \sum_{i=1}^3 \sum_{n=1}^{+\infty} p_{i,n} \lambda_c^n = 1$$

We conclude that $\varphi^{m, \lambda_m, 2}(o, y, x_i)$ converges towards $\sum_{n=1}^{+\infty} p_{i,n} \lambda_c^n$ when $m \rightarrow +\infty$. \square

Proof of point 3 of Theorem 66. It remains to prove that

$$\lim_{m \rightarrow +\infty, \lambda > \lambda_c(\mathcal{T}_{\mathbb{H}})} \varphi^{m, \lambda, k}(y_1, \dots, y_k) = \varphi^{\mathbb{H}, \lambda, k}(y_1, \dots, y_k).$$

It is enough to prove the theorem in the case $k = 2$, we use the same method for $k \geq 3$. Fix $\lambda > \lambda_c(\mathcal{T}_{\mathbb{H}})$ and $\varepsilon > 0$. By Proposition 59, we have

$$(7.12) \quad \lim_{m \rightarrow +\infty} \lambda_c(\mathcal{T}^m) = \lambda_c(\mathcal{T}_{\mathbb{H}}).$$

Therefore, there exists $m_0 > 0$ such that for any $m \geq m_0$,

$$(7.13) \quad \lambda > \lambda_c(\mathcal{T}^m) \quad \text{and} \quad (1 - C(\lambda, \mathcal{T}^m))^m < \varepsilon.$$

Let \mathcal{T} be the tree defined by:

$$\begin{cases} |\mathcal{T}_i| = 1 \text{ for all } i \leq m \\ \mathcal{T}_p = \{v\} \\ \mathcal{T}^v = \mathcal{T}^m \end{cases}$$

We choose n_0 (depends on m) such that for all $n > n_0$, we have

$$(1 - C(\lambda, \mathcal{T}^n))^n < \varepsilon$$

By considering the self-avoiding walks in the rectangle whose vertices are $(-n_0, 1); (-n_0, m_0); (n_0, m_0); (n_0, 1)$ and by a simple argument, we can see that for all $n > m_0 n_0$,

$$|\varphi^{n, \lambda, k}(y_1, \dots, y_k) - \varphi^{\mathbb{H}, \lambda, k}(y_1, \dots, y_k)| < 2\varepsilon.$$

Since ε is arbitrary, this complete the proof of theorem. \square

Remark 67. *Theorem 66 allows us to define a critical probability measure \mathbb{P}_{λ_c} on $T_{\mathbb{H}}$. Note that this critical probability measure is exactly Kesten's measure as in Section 5.2.*

7.2. Conjectures. If we take a sequence of cutsets $\pi_n := \mathcal{T}_n$ and we set $c(e) = \left(\frac{1}{\mu}\right)^{|e|}$, then

$$\sum_n \left(\sum_{e \in \pi_n} c(e) \right)^{-1} = \sum_{n=1}^{+\infty} \frac{\mu^n}{c_n}.$$

If the prediction of Nienhuis [18] holds, we obtain

$$\sum_{n=1}^{+\infty} \frac{\mu^n}{c_n} \geq c \sum_{n=1}^{+\infty} \frac{1}{n^{\frac{11}{32}}} = +\infty$$

By Theorem 19, we can establish the following conjecture.

Conjecture 68. *The biased random walk RW_{λ_c} on $T_{\mathbb{H}}$ (or $T_{\mathbb{Z}^2}$) is recurrent.*

Finally, we believe that for every $k \geq 1$ and $y_1, y_2, \dots, y_k \in V(T_{\mathbb{H}})$,

$$\lim_{\lambda \rightarrow \lambda_c(T_{\mathbb{H}})} \varphi^{\mathbb{H}, \lambda, k}(y_1, \dots, y_k) = \varphi^{\lambda_c, k}(y_1, \dots, y_k).$$

Conjecture 69. *The following convergence diagram holds*

$$\begin{array}{ccc} \varphi^{m, \lambda, k}(y_0, y_1, \dots, y_k) & \xrightarrow[\lambda > \lambda_c(T_{\mathbb{H}})]{m \rightarrow +\infty} & \varphi^{\mathbb{H}, \lambda, k}(y_0, y_1, \dots, y_k) \\ \lambda \rightarrow \lambda_c(T^m) \downarrow & & \downarrow \lambda \rightarrow \lambda_c \\ \varphi^{m, \lambda_m, k}(y_0, y_1, \dots, y_k) & \xrightarrow[m \rightarrow +\infty]{} & \varphi^{\lambda_c, k}(y_0, y_1, \dots, y_k) \end{array}$$

REFERENCES

- [1] R. BAUERSCHMIDT, H. DUMINIL-COPIN, J. GOODMAN, AND G. SLADE, *Lectures on self-avoiding walks*, Probability and Statistical Physics in Two and More Dimensions (D. Ellwood, CM Newman, V. Sidoravicius, and W. Werner, eds.), Clay Mathematics Institute Proceedings, 15 (2012), pp. 395–476.
- [2] A. BERRETTI AND A. D. SOKAL, *New Monte Carlo method for the self-avoiding walk*, Journal of Statistical Physics, 40 (1985), pp. 483–531.
- [3] S. R. BROADBENT AND J. M. HAMMERSLEY, *Percolation processes: I. crystals and mazes*, in Mathematical Proceedings of the Cambridge Philosophical Society, vol. 53, Cambridge University Press, 1957, pp. 629–641.
- [4] B. DYHR, M. GILBERT, T. KENNEDY, G. F. LAWLER, AND S. PASSON, *The self-avoiding walk spanning a strip*, Journal of Statistical Physics, 144 (2011), pp. 1–22.
- [5] P. J. FLORY, *Principles of Polymer Chemistry*, Cornell University Press, 1953.
- [6] H. FURSTENBERG, *Disjointness in ergodic theory, minimal sets, and a problem in diophantine approximation*, Theory of Computing Systems, 1 (1967), pp. 1–49.
- [7] J. M. HAMMERSLEY AND K. W. MORTON, *Poor man's monte carlo*, Journal of the Royal Statistical Society. Series B (Methodological), (1954), pp. 23–38.
- [8] J. M. HAMMERSLEY AND D. J. WELSH, *Further results on the rate of convergence to the connective constant of the hypercubical lattice*, The Quarterly Journal of Mathematics, 13 (1962), pp. 108–110.

- [9] T. E. HARRIS, *A lower bound for the critical probability in a certain percolation process*, in Mathematical Proceedings of the Cambridge Philosophical Society, vol. 56, Cambridge University Press, 1960, pp. 13–20.
- [10] H. KESTEN, *On the number of self-avoiding walks*, Journal of Mathematical Physics, 4 (1963), pp. 960–969.
- [11] ———, *The critical probability of bond percolation on the square lattice equals 1/2*, Communications in mathematical physics, 74 (1980), pp. 41–59.
- [12] ———, *The incipient infinite cluster in two-dimensional percolation*, Probability Theory and Related Fields, 73 (1986), pp. 369–394.
- [13] G. F. LAWLER, O. SCHRAMM, AND W. WERNER, *On the scaling limit of planar self-avoiding walk*, in Fractal geometry and applications: a jubilee of Benoît Mandelbrot, Part 2, vol. 72 of Proc. Sympos. Pure Math., Amer. Math. Soc., Providence, RI, 2004, pp. 339–364.
- [14] R. LYONS, *Random walks and percolation on trees*, The annals of Probability, (1990), pp. 931–958.
- [15] R. LYONS AND Y. PERES, *Probability on Trees and Networks*, Cambridge University Press, 2016. Available at <http://pages.iu.edu/~rdlyons/>.
- [16] N. MADRAS AND G. SLADE, *The self-avoiding walk*, Springer Science & Business Media, 2013.
- [17] C. S. J. NASH-WILLIAMS, *Random walk and electric currents in networks*, in Mathematical Proceedings of the Cambridge Philosophical Society, vol. 55, Cambridge Univ Press, 1959, pp. 181–194.
- [18] B. NIENHUIS, *Exact critical point and critical exponents of $o(n)$ models in two dimensions*, Physical Review Letters, 49 (1982), p. 1062.
- [19] D. RANDALL, *Counting in lattices: combinatorial problems from statistical mechanics*, PhD thesis, International Computer Science Institute (ICSI) Technical Report Number TR-055-94, 1994.
- [20] A. D. SOKAL, *Monte Carlo methods for the self-avoiding walk*, Nuclear Physics B - Proceedings Supplements, 47 (1996), pp. 172–179.
- [21] W. WERNER, *Percolation et modèle d'ising*, (2009).

VINCENT BEFFARA, UNIV. GRENOBLE ALPES, CNRS, INSTITUT FOURIER, F-38000
GRENOBLE, FRANCE

E-mail address: `vincent.beffara@univ-grenoble-alpes.fr`

CONG BANG HUYNH, UNIV. GRENOBLE ALPES, CNRS, INSTITUT FOURIER, F-38000
GRENOBLE, FRANCE

E-mail address: `cong-bang.huynh@univ-grenoble-alpes.fr`