



**HAL**  
open science

# Servo-hydro and unsteady aerodynamic simulation of Floating Vertical Axis Wind Turbines

Vincent Leroy, Jean-Christophe Gilloteaux, Maxime Philippe, Aurélien  
Babarit, Pierre Ferrant

► **To cite this version:**

Vincent Leroy, Jean-Christophe Gilloteaux, Maxime Philippe, Aurélien Babarit, Pierre Ferrant. Servo-hydro and unsteady aerodynamic simulation of Floating Vertical Axis Wind Turbines. 23e Congrès Français de Mécanique, Aug 2017, Lille, France. hal-01635075

**HAL Id: hal-01635075**

**<https://hal.science/hal-01635075>**

Submitted on 24 May 2019

**HAL** is a multi-disciplinary open access archive for the deposit and dissemination of scientific research documents, whether they are published or not. The documents may come from teaching and research institutions in France or abroad, or from public or private research centers.

L'archive ouverte pluridisciplinaire **HAL**, est destinée au dépôt et à la diffusion de documents scientifiques de niveau recherche, publiés ou non, émanant des établissements d'enseignement et de recherche français ou étrangers, des laboratoires publics ou privés.

# Servo-hydro and unsteady aerodynamic simulation of Floating Vertical Axis Wind Turbines

V. LEROY<sup>a,b</sup>, J.-C. GILLOTEAUX<sup>b</sup>, M. PHILIPPE<sup>a</sup>, A. BABARIT<sup>b</sup>,  
P. FERRANT<sup>b</sup>

a. INNOSEA, 1 rue de la Noë, 44321 Nantes, France

b. LHEEA Lab, Centrale Nantes, 44321 Nantes Cedex 3, France

Contact: [vincent.leroy@ec-nantes.fr](mailto:vincent.leroy@ec-nantes.fr)

## Résumé

*Des études récentes mettent en évidence l'intérêt des éoliennes à axe vertical (Vertical Axis Wind Turbines, VAWT) pour des applications flottantes [1]. Si les efforts aérodynamiques des éoliennes flottantes peuvent être très instationnaires lors d'importants mouvements des plateformes [2], ils le sont encore davantage pour les éoliennes à axe vertical. En effet, ces rotors interagissent fortement avec leur sillage et les efforts qu'ils subissent sont très oscillants par rapport à ceux s'appliquant aux éoliennes à axe horizontal [3] [4]. Les modèles stationnaires couramment utilisés ne sont donc a priori plus valides pour une éolienne flottante soumise à de grands mouvements. Le couple de réaction de la génératrice induit des oscillations en lacet et des efforts périodiques dans les lignes d'ancrage, pouvant provoquer à long terme des ruptures en fatigue des lignes [4]. Un nouvel outil de simulation servo-hydro-aérodynamique des éoliennes flottantes a été développé [5], couplant InWave [6], logiciel de tenue à la mer développé à INNOSEA en collaboration avec le LHEEA de Centrale Nantes (France), et le code CACTUS [7], développé au Sandia National Laboratories (USA), reposant sur la théorie instationnaire vortex sillage libre. Une première application sur un cas d'éolienne flottante à axe horizontal est présentée dans [5]. Ce papier présente l'environnement couplé et une étude sur la VAWT DeepWind [8], d'abord fixe puis flottante, afin de mettre en évidence certains phénomènes oscillants critiques pour une telle VAWT flottante.*

## Abstract

*Recent studies show evidence that Vertical Axis Wind Turbines (VAWTs) can be of interest for floating applications [1] compared to Horizontal Axis Wind Turbines (HAWTs). The aerodynamics of floating wind turbines can be very unsteady in large structure motions as shown in [2], and it is even more for VAWTs than for HAWTs as they strongly interact with their wake and the thrust and torque acting on their rotors is oscillating [3] [4]. Momentum theories based on the assumption of a steady flow on the rotor may not be accurate enough for floating turbines. Also, the reaction torque of the generator of a floating VAWT induces oscillations in yaw that create fatigue loadings in the mooring lines as shown in [4]. A new simulation tool has been developed coupling the seakeeping software InWave [6] developed in INNOSEA in collaboration with the LHEEA Lab of Centrale Nantes (France), to CACTUS [7], an unsteady aerodynamic solver based on the free vortex wake theory and developed at Sandia National Laboratories (USA). A first test-case on a floating HAWT, with comparison to results*

from FAST [9] has been presented in [5]. This paper presents the coupled environment and a study on the fixed and floating DeepWind VAWT [8] to demonstrate key issues on the behaviour of such a system concerning the reaction torque of the generator and the loads induced in the mooring system.

**Key words: floating wind turbine, VAWT, unsteady aerodynamics, coupling, numerical modelling.**

## 1. Introduction

A lot of research has focused over the last decade on Floating Offshore Wind Turbines (FOWTs). Vertical Axis Wind Turbines (VAWTs) have also been studied for floating applications but the aerodynamics of such turbines is complex to model as it is highly unsteady given that blades pass through each other's wake along a rotor revolution. Floating turbines are submitted to even more unsteady aerodynamics as their platforms are moving [2]. Whilst Horizontal Axis Wind Turbines (HAWTs) were industrialized for offshore applications, VAWTs were not considered as they were less efficient for onshore application. However, they show some interests for floating cases. For example, they can have lower centres of thrust and gravity and thus improve their stability compared to HAWTs, inducing a reduction in costs of substructures [1]. Their design and energy production does not depend on the wind direction: no yaw positioning of the turbine is thus needed. But the reaction torque applied at the generator needs to be accounted for by the mooring system, which may imply fatigue loads in the mooring lines. Appropriate control laws must be developed in order to enhance energy production while diminishing the impact of the reaction torque on the mooring lines and structure.

To study the seakeeping of Floating HAWTs and VAWTs two codes have been coupled [5]: *InWave* [6], a seakeeping code developed at INNOSEA (Nantes, France) in collaboration with the LHEEA Lab of Centrale Nantes, and *CACTUS* [7], an unsteady aerodynamic solver developed at Sandia National Laboratories (USA). *InWave* integrates the linear potential flow solver *Nemoh*, developed at Centrale Nantes and solves the equation of motion in time domain through a multi-body algorithm. It also accounts for regular and irregular waves and mooring. *CACTUS* is a lifting-line free vortex wake code, inherently unsteady and assuming potential flow. A first work of verification [5] was lead on the OC3 test case [10], considering the NREL 5MW HAWT designed at the National Renewable Energy Laboratory (NREL) on the OC3Hywind SPAR. The results from *InWave-CACTUS* were compared with those from *FAST* [9].

This paper presents the coupled numerical tools and a study on the fixed and floating DeepWind VAWT [9] to demonstrate key issues on the behaviour of such a system, especially concerning the reaction torque of the generator and the loads induced in the mooring system.

## 2. Simulation tools

The coupled simulation tool has been developed and tested on a first test case based on the OC3 project [10], including the NREL 5MW rotor supported by the OC3Hywind SPAR platform. The results of this study were compared with those from FAST [9] and show good agreement as presented in [5]. The study included decay tests, regular and irregular waves, without wind in the first place and then combined with constant and turbulent wind at different wind speeds.

## 2.1. Multibody solver and hydrodynamics

*InWave* [6] is developed at INNOSEA in collaboration with the LHEEA Lab of Centrale Nantes (France). It solves the equation of motion in time domain for a floating system with one or numerous rigid bodies, including regular or irregular waves. It is based on a multibody algorithm [11] developed at Centrale Nantes and integrates the linear potential flow solver *Nemoh* [12], also developed at Centrale Nantes. *Nemoh* computes the first order hydrodynamic loads (excitation force, diffraction, radiation damping and added mass). Morison formulation can also be used in the computation of the hydrodynamic loads.

Additional modules have been coupled to *InWave* in order to model floating wind turbines: a mooring module, an unsteady aerodynamics module and a control module. The mooring module integrates MAP++ [13], a quasi-steady mooring solver.

## 2.2. Unsteady aerodynamics

In order to model the unsteady aerodynamics of floating VAWTs, methods such as the Double Multiple Streamtube Theory (DMST) [1] may not be accurate enough for large motions of floating systems as they assume a steady flow. The use of a free vortex method has then been chosen for the present development. This method can be used either for HAWTs or for VAWTs and shows a good compromise between computational cost and unsteady aerodynamic loads accuracy. *CACTUS* [7] is an open-source lifting-line free vortex wake method that has been implemented at the SNL. It has been presented and validated in [7] on fixed horizontal and vertical axis rotors. It works in time-domain and also includes a geometry editor for the studied rotors. *CACTUS* has been adapted when coupled to *InWave* to account for:

- motions induced by the platform degrees of freedom (DOF);
- variable rotational speed computed by the multibody solver;
- 3D variable irregular winds that can be generated by reading input files created by *TurbSim* [14] (external tool).

## 2.3. Control algorithm

In order to study the DeepWind VAWT [15], a dedicated control algorithm developed by Merz and Svendsen [16], improved and used in [4] on the same rotor, has been implemented inside *InWave* to calculate the generator torque. This control algorithm, presented in Figure 1, uses a PID corrector. It allows to maximize the captured power for winds under the rated wind speed  $V = 14 \text{ m} \cdot \text{s}^{-1}$ . In [4], Cheng et al. show an improvement of this controller by setting the reference rotational speed in function of the wind speed in order to keep the captured power constant above the rated wind speed. It thus linearly decreases the reference rotational speed in function of the wind.

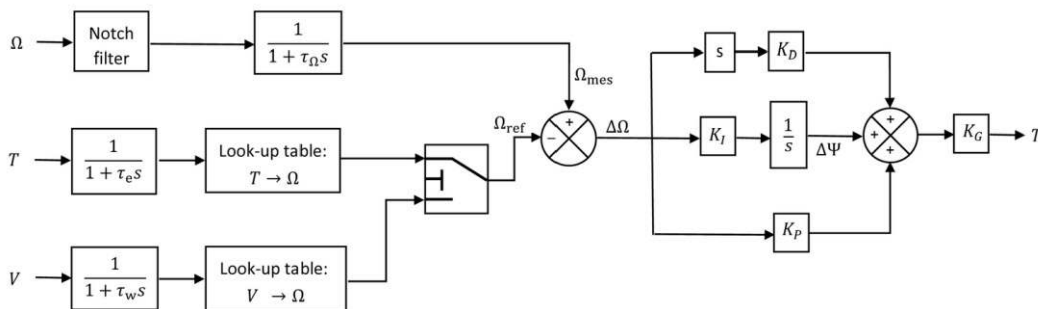

Figure 1: Control algorithm computing the generator torque using a PID architecture (figure from [17]).

A notch filter is applied to the measured rotational speed  $\Omega$  of the rotor to avoid the 2P frequency which could result in strong oscillations in the computed torque. A low pass filter is then applied to this filtered rotational speed to obtain  $\Omega_{mes}$ . The reference speed is determined by look-up tables as follows:

- For below-rated wind speeds  $V < V_N$ , the measured and low-passed filtered torque  $T$  gives the reference rotational speed;
- For above-rated wind speed  $V \geq V_N$ , the measured and low-passed wind speed gives the reference rotational speed.

The PID controller then computes the torque  $T$  to apply at the generator from the error  $\Delta\Omega = \Omega_{mes} - \Omega_{ref}$ .

## 2.4. Coupling *InWave* and *CACTUS* in a modular framework

The modules presented above are thus coupled in a modular framework presented in Figure 2. The multibody and hydrodynamic solver communicates with the different separate modules at each time-step through a RK4 integrator.

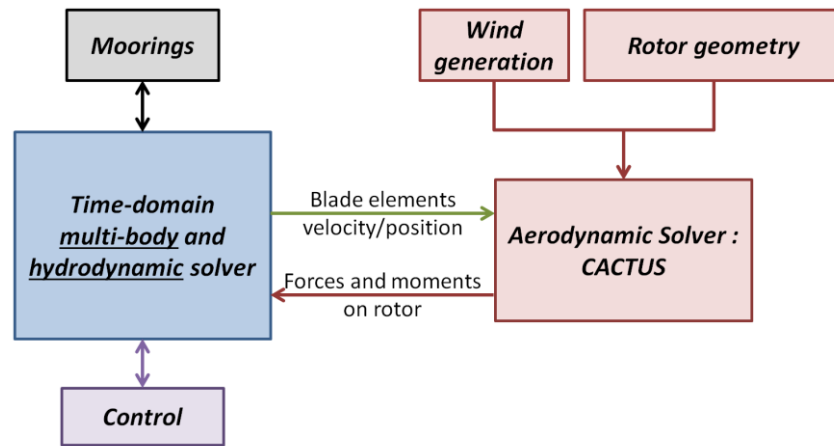

Figure 2: Coupling *InWave* and *CACTUS*

## 3. Study on the DeepWind VAWT

This part focuses on the first study on the DeepWind VAWT, presented in [8]. It is a 5MW Darrieus (troposkein) floating VAWT. The rotor is 63.74 m radius and 129.56 m height as described in [18] and [8]. The blades are 7.45 m chord with NACA0018 profiles. The pitch of the blades is fixed.

The design of the platform has been modified as presented in [4] in order to compare the behaviour of the floating wind turbine with the OC3 test case [10], considering the NREL 5MW HAWT on the OC3Hywind SPAR platform. The Darrieus rotor has thus been mounted on the OC3Hywind platform and the generator has been located at the mean water level. The ballasts of the SPAR have been adapted to keep the same 120 m draft as for the HAWT. Main parameters are described in Table 1. The mooring design is the one used in the OC3 test case, including three catenary lines at  $120^\circ$  from each other with two lines on the upwind side of the system as presented on Figure 3. The used hydrodynamic model is the same one as in [5]. The effects of the tower (thrust, wake deflection and Magnus effect) are neglected.

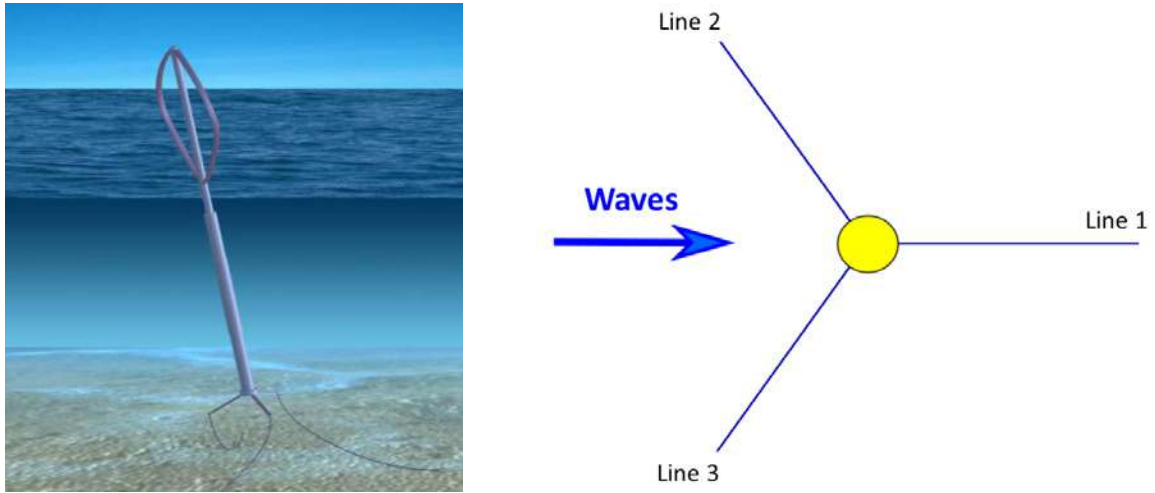

Figure 3: DeepWind VAWT concept with floating and rotating foundation (from [18]) and mooring system layout

Table 1: Main parameters of the modified DeepWind floating VAWT

Rated power (MW)	5	Cut-in, rated, cut-out wind speed (m/s)	5, 14, 25
Rotor radius (m)	63.74	Water depth (m)	320
Rotor height (m)	129	Draft (m)	120
Chord (m)	7.45	Platform mass (kg)	7.47E6
Rotor CM height (m)	64.7	Platform CM height (m)	-89.9
Rated rotational speed (RPM)	5.26	Platform roll/pitch inertia (kg.m <sup>2</sup> ) (about CM)	4.23E9
Rotor mass (kg)	7.54E5	Platform inertia in yaw (kg.m <sup>2</sup> )	1.64E8

### 3.1. Onshore VAWT

A first study is lead on the bottom-fixed VAWT, considering the DeepWind rotor. The converted power and the aerodynamic torque are plotted in function of the wind speed on Figure 4. On this figure, results obtained with *InWave* are compared with those from [4], computed through the Actuator Cylinder theory, and to the equivalent data from the NREL 5MW HAWT [19]. Discrepancies between the results from *InWave* and [4] may come from differences in the aerodynamic models. Both turbines reach the rated power of 5MW at their rated wind speed. The optimal power coefficient of the HAWT is stronger than the one of the VAWT, the power extraction of the HAWT is thus higher for below-rated wind speed ( $11.4 \text{ m} \cdot \text{s}^{-1}$  for the HAWT).

The thrust of the HAWT is maximal at the rated point, and then decreases for above-rated wind speed as the blades are pitched in order to keep a constant power production. This strongly decreases the thrust force. However, the mean thrust force of the VAWT keeps on increasing, which may involve large offset and motion amplitudes for a floating structure.

The time-series of the thrust force and transversal aerodynamic force acting on the VAWT and the HAWT have been calculated at a wind speed of  $U_\infty = 14 \text{ m} \cdot \text{s}^{-1}$  with *InWave* and compared on Figure 5. The thrust on the VAWT is oscillating at the 2P frequency, while the thrust on the HAWT is constant.

Some of the phenomena pointed out in [3] can be observed in the following with the DeepWind rotor. The thrust on the VAWT is oscillating from 0 to 1200 kN. The transversal aerodynamic force is also oscillating between -600 and 800 kN and its mean value is about 100 kN. That non-zero mean value would impose an offset in the turbine's roll and sway if it was floating. The aerodynamic torque acting on the VAWT rotor is also plotted on Figure 6. It is oscillating from 0 to approximately 21.5 kN.m.

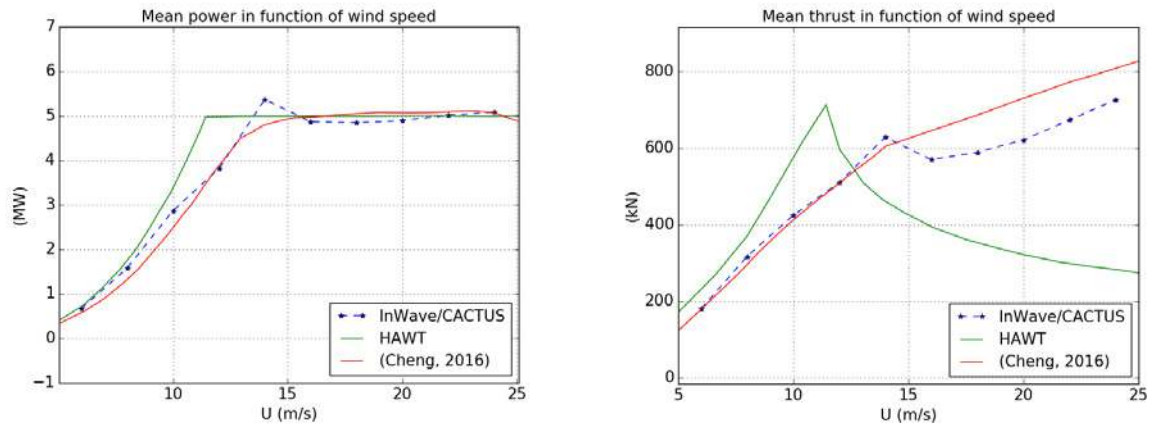

Figure 4: Converted power (MW) and aerodynamic thrust (kN) of the NREL 5MW HAWT and the DeepWind VAWT.

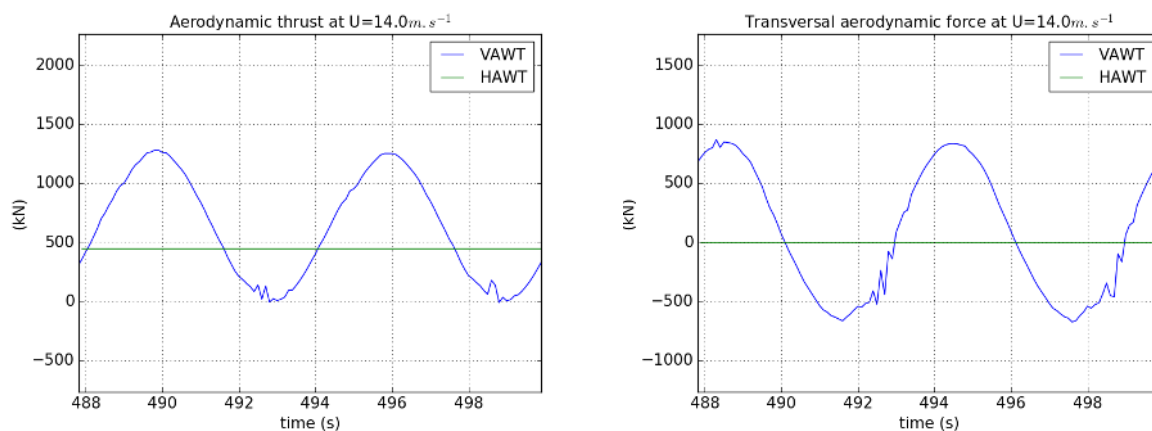

Figure 5: Aerodynamic thrust and transversal force at  $U = 14 \text{ m.s}^{-1}$ .

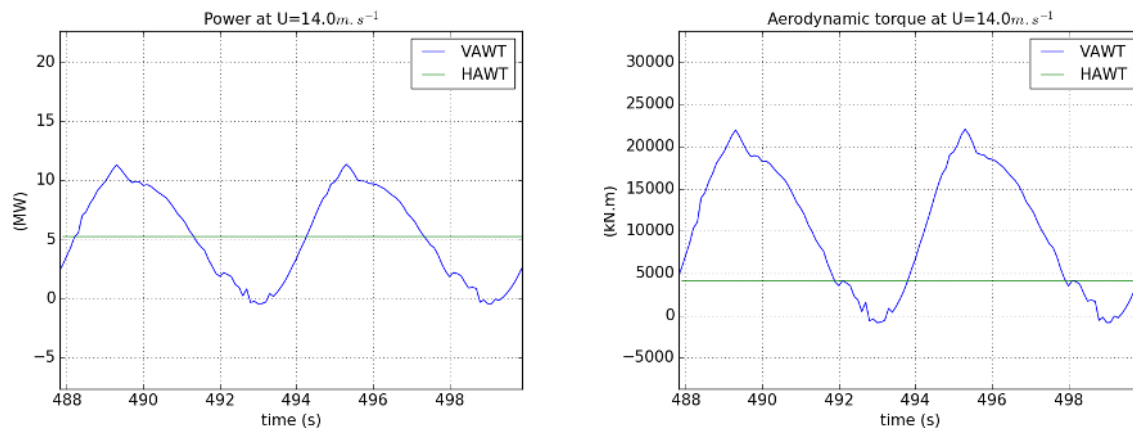

Figure 6: Power and aerodynamic torque acting on the bottom-fixed rotor at  $U = 14 \text{ m.s}^{-1}$ .

### 3.2. Offshore floating VAWT

Floating VAWT and HAWT under steady wind and regular wave conditions are now considered in this section. The wave period is  $T = 10 \text{ s}$  and the amplitude is  $A = 3 \text{ m}$ . The wind is steady with a uniform speed of  $U_\infty = 18 \text{ m.s}^{-1}$ . The platform has six degrees of freedom and the torque between the rotor and the platform is controlled by the control module of *InWave*. The behaviour of the VAWT is compared to the one of the HAWT.



On Figure 7 are plotted the motion time series of both platforms. Only the ends of the simulations are observed in order to avoid any transient effects. It can be seen that both platforms have a similar behaviour in surge, heave and pitch, except the different offset due to various aerodynamic thrust at this wind speed (see Figure 4). Oscillations are at wave frequency. However, sway, roll and yaw responses are utterly different. The aerodynamic transversal force pointed out in part 3.1 induces oscillations at  $2P$  frequency ( $\omega_{2P} = 0.87 \text{ rad.s}^{-1}$ ) to the VAWT in sway and roll. The differences in the loads acting on the VAWT also induce a response at lower frequency because of the mooring stiffness. It can be seen that the mean roll is about  $1^\circ$  and the mean sway is about  $-4\text{m}$ , which is significant. Also, the yaw response of the VAWT is very important. It is constantly zero for the HAWT but oscillates at  $2P$  frequency between  $0^\circ$  and  $10^\circ$  with a mean value of  $5^\circ$  for the VAWT.

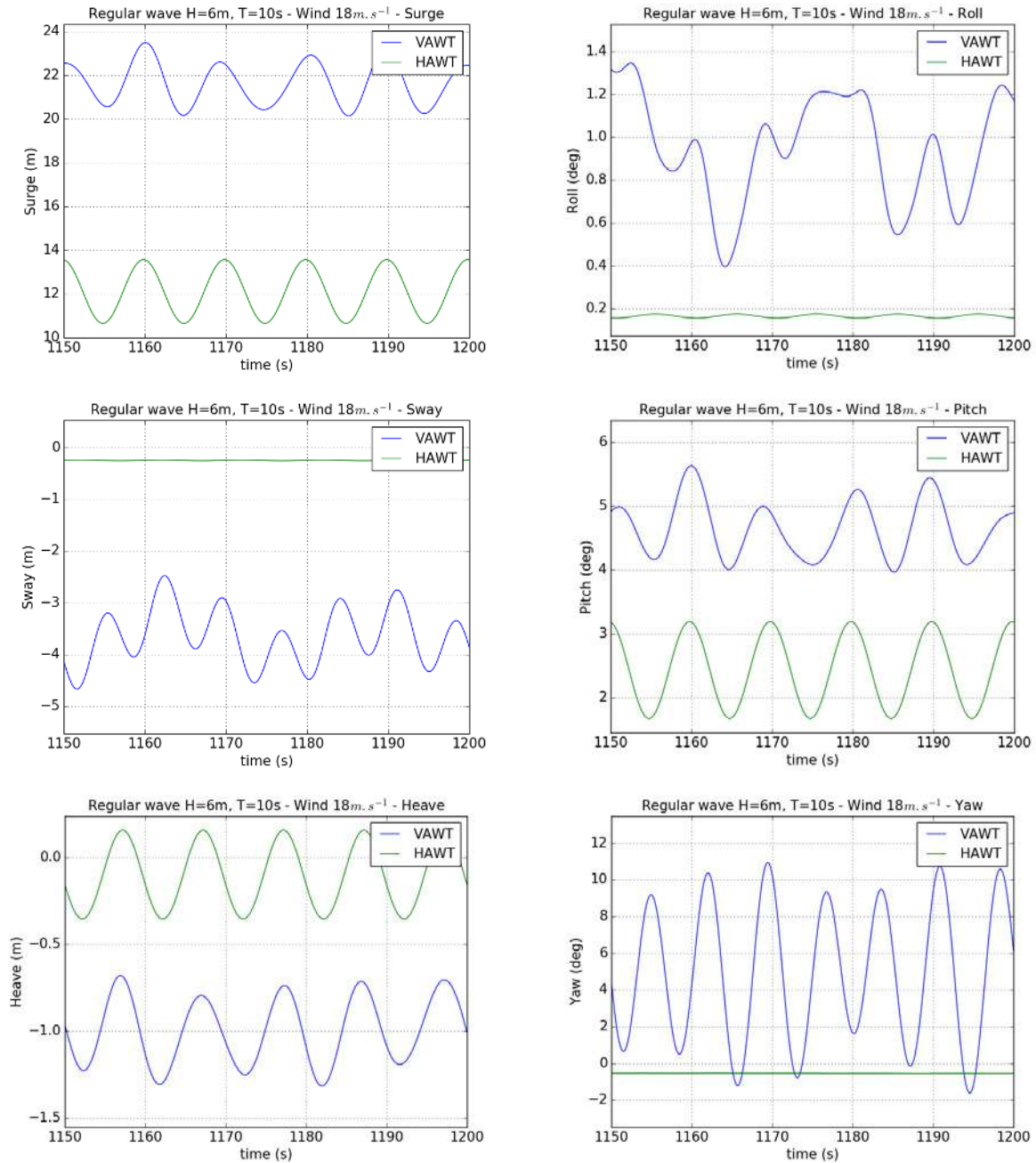

**Figure 7: Motion time-series comparison of the floating VAWT and HAWT**

These motions induce unusual loads in the moorings of the floating VAWT. Figure 8 shows the Power Spectral Density (PSD) of the tension in mooring line 2 of the floating turbines. The mooring of the



HAWT only bears the loads at wave frequency (low-frequency contributions can be seen as well depending on the sea-state). For the VAWT, a peak at 2P frequency can be observed corresponding mainly to the response of the mooring system to the yaw motion. Another peak is observed at lower frequency corresponding to a coupling between the platform natural periods. The response at wave frequency is higher for the VAWT but this comes from the higher aerodynamic thrust at  $U_\infty = 18m.s^{-1}$ . Compared to the HAWT, these additional periodic tensions induced by the unsteady aerodynamic loading and the reaction torque of the generator of the VAWT could strongly affect the mooring lines and induce fatigue loadings.

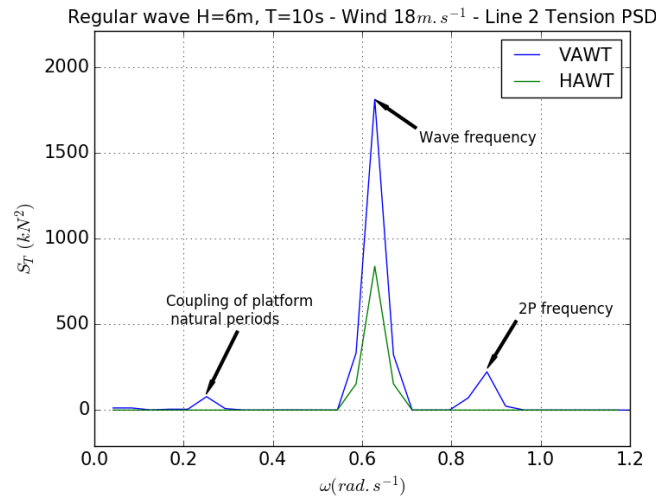

Figure 8: PSD of the tension in a mooring line of the floating VAWT

## 4. Conclusion

This paper presents a coupling between *InWave* and *CACTUS* dedicated to the study of Floating Offshore Wind Turbines. The code can be used for either HAWTs or VAWTs, but still needs a full work of validation on a floating VAWT as *CACTUS* has been validated for onshore VAWTs or HAWTs only [7]. A first code-to-code validation has been performed based on the OC3 test case. It considers the NREL 5MW HAWT installed on the OC3Hywind SPAR as presented in [5]. This paper presented the first study with this new tool on the DeepWind VAWT. Results of the onshore case have been compared with those from [4]. A brief comparison with the results from the HAWT shows that floating VAWTs may have a very different behaviour at sea. More load cases would be needed to more accurately assess the differences between the behaviours of the HAWT and the VAWT, including irregular waves and turbulent wind. However, it can already be observed that the reaction torque of the generator induces important oscillations in yaw that could impact the mooring lines. The present study uses a SPAR-type floater. With this type of floater, the yaw does not generate any hydrodynamic forces. For instance, a semi-submersible floater would reduce the yaw oscillations of the platform. Oscillating loads should be further investigated. In order to more accurately model the mooring response, a dynamic mooring model should be implemented in *InWave*. A deeper study will be done on the floating VAWT in order to precise the oscillating tensions in the mooring lines.

## References

- [1] M. Borg, A. Shires and M. Collu, "Offshore floating vertical axis wind turbines, dynamic modelling state of the art. Part I: Aerodynamics," *Renewable and Sustainable Energy Reviews*,

- pp. 1214-1225, 2014.
- [2] T. Sebastian and M. A. Lackner, “Characterization of the unsteady aerodynamics of offshore floating wind turbines,” *Wind Energy*, 2013.
- [3] M. Borg and M. Collu, “A comparison between the dynamics of horizontal and vertical axis offshore floating wind turbines,” *Phil. Trans. R. Soc. A 373*, 2015.
- [4] Z. Cheng, K. Wang, Z. Gao and T. Moan, “A comparative study on dynamic responses of spar-type floating horizontal and vertical axis wind turbines,” *Wind Energy*, 2016.
- [5] V. Leroy, J. -C. Gilloteaux, M. Philippe, A. Babarit and P. Ferrant, “Development of a simulation tool coupling hydrodynamics and unsteady aerodynamics to study Floating Wind Turbines,” *Proceedings of the ASME 2017 36th International Conference on Ocean, Offshore and Arctic Engineering, OMAE2017, June 25-30, 2017, Trondheim, Norway*, 2017.
- [6] A. Combourieu, M. Philippe, F. Rongère and A. Babarit, “InWave: a new flexible tool dedicated to Wave Energy Converters,” *In Proceedings of the ASME 2014 33rd International Conference on Ocean, Offshore and Arctic Engineering, OMAE2014, June 8-13, 2014, San Francisco, California, USA*, 2014.
- [7] J. C. Murray and M. Barone, “The development of CACTUS, a wind and marine turbine performance simulation code,” *in proceedings of 49th AIAA Aerospace Sciences Meeting*, 2011.
- [8] U. S. Paulsen, L. Vita, H. A. Madsen, J. Hattel, E. Ritchie, K. M. Leban, P. A. Berthelsen and S. Carstensen, “1st DeepWind 5 MW baseline design,” *Energy Procedia*, 2012.
- [9] National Renewable Energy Laboratory (NREL) (USA), “NWTC Information portal - FAST,” [Online]. Available: <https://nwtc.nrel.gov/FAST>. [Accessed 2015 11 2015].
- [10] J. M. Jonkman and W. Musial, “Offshore Code Comparison Collaboration (OC3) for IEA Task 23 Offshore Wind Technology and Deployment,” (*Technical report*) NREL/TP-5000-48191, 2010.
- [11] F. Rongère and A. H. Clément, “Systematic dynamic modeling and simulation of multibody offshore structures: application to wave energy converters,” *Proceedings of the ASME 2013 32nd International Conference on Ocean, Offshore and Arctic Engineering, OMAE2013, June 9-14, 2013, Nantes, France*, 2013.
- [12] A. Babarit and G. Delhommeau, “Theoretical and numerical aspects of the open source BEM solver NEMOH,” *In Proceedings of the 11th European Wave and Tidal Energy Conference 6-11th Sept 2015, Nantes, France*, 2015.
- [13] NREL - NWTC Information Portal, “MAP++,” NREL, [Online]. Available: <https://nwtc.nrel.gov/MAP>. [Accessed 29 06 2016].
- [14] National Renewable Energy Laboratory (NREL) (USA), “TurbSim,” [Online]. Available: <https://nwtc.nrel.gov/TurbSim>. [Accessed 12 01 2017].
- [15] U. S. Paulsen, H. A. Madsen, K. A. Kragh, P. H. Nielsen, I. Baran, J. Hattel, E. Ritchie, K. Leban, H. G. Svendsen and P. A. Berthelsen, “DeepWind-from idea to 5 MW concept,” *Energy Procedia*, 2014.
- [16] K. O. Merz and H. G. Svendsen, “A control algorithm for the DeepWind floating vertical-axis wind turbine,” *Journal of Renewable and Sustainable Energy* 5, 2013.
- [17] Z. Cheng, “Integrated Dynamic Analysis of Floating Vertical Axis Wind Turbines,” *Norwegian University of Science and Technology (NTNU)*, 2016.
- [18] L. Vita, T. F. Pedersen and H. A. Madsen, “Offshore Vertical Axis Wind Turbine with Floating and Rotating Foundation,” *Kgs. Lyngby, Denmark: Technical University of Denmark*.

- [19] J. Jonkman, “Definition of the Floating System for Phase IV of OC3. Technical Report,”  
*National Renewable Energy Laboratory (NREL) - Technical Report NREL/TP-500-47535*, 2010.