



HAL
open science

A method using the approach of Moreau and Panagiotopoulos for the mathematical formulation of non-regular circuits in electronics

Khalid Addi, Samir Adly, Bernard Brogliato, Daniel Goeleven

► To cite this version:

Khalid Addi, Samir Adly, Bernard Brogliato, Daniel Goeleven. A method using the approach of Moreau and Panagiotopoulos for the mathematical formulation of non-regular circuits in electronics. *Nonlinear Analysis: Hybrid Systems*, 2007, 1 (1), pp.30-43. 10.1016/j.nahs.2006.04.001 . hal-00450964v2

HAL Id: hal-00450964

<https://hal.science/hal-00450964v2>

Submitted on 12 Nov 2017

HAL is a multi-disciplinary open access archive for the deposit and dissemination of scientific research documents, whether they are published or not. The documents may come from teaching and research institutions in France or abroad, or from public or private research centers.

L'archive ouverte pluridisciplinaire **HAL**, est destinée au dépôt et à la diffusion de documents scientifiques de niveau recherche, publiés ou non, émanant des établissements d'enseignement et de recherche français ou étrangers, des laboratoires publics ou privés.

A method using the approach of Moreau and Panagiotopoulos for the mathematical formulation of non-regular circuits in electronics

Khalid Addi^{a,*}, Samir Adly^b, Bernard Brogliato^c, Daniel Goeleven^a

^aIREMIA, University of La Reunion, 97400 Saint-Denis, France

^bDMI-XLIM, University of Limoges, 87060 Limoges, France

^cINRIA Rhône-Alpes, 38334 Saint-Ismier, France

In this paper, we show how the approach of Moreau and Panagiotopoulos can be used to develop a suitable method for the formulation and mathematical analysis of circuits involving devices like diodes and thyristors.

Keywords: Superpotential approach of Moreau and Panagiotopoulos; Mathematical model in electronics; Set-valued graphs in electronics; Ampere–volt characteristics; Variational and hemivariational inequalities; Non-regular circuits and systems; Clarke’s subdifferential; Set-valued differential systems

1. Introduction

In order to deal with nonlinear phenomena like unilateral contact and Coulomb friction, the notion of superpotential has been introduced by Moreau [31] for convex but generally non-differentiable energy functionals. This approach has led to a major generalization of the concept of superpotential by Panagiotopoulos [37] so as to recover the case of non-convex energy functionals. The approach of Moreau and Panagiotopoulos is now well established and often used for the treatment of various problems in elasticity, plasticity, fluid mechanics and robotics.

Our aim in this paper is to extend the superpotential approach of Moreau and Panagiotopoulos in a new direction. Indeed, in this paper, we show how the approach of Moreau and Panagiotopoulos can be used to develop a suitable method for the formulation and mathematical analysis of circuits involving devices like diodes, diacs and thyristors.

Precise descriptions including ampere–volt characteristics of electrical devices can be found in the database and catalogs of electronics companies (see e.g. [3,5,7,8]), in the appropriate engineering literature (see e.g. [30]) and in the documentation available on the Net (see e.g. [1,2,4,6]). It is then easy to remark that ampere–volt characteristics of various devices like diodes and thyristors are set-valued graphs.

* Corresponding author.

E-mail addresses: addi@univ-reunion.fr (K. Addi), adly@unilim.fr (S. Adly), bernard.brogliato@inrialpes.fr (B. Brogliato), goeleven@univ-reunion.fr (D. Goeleven).

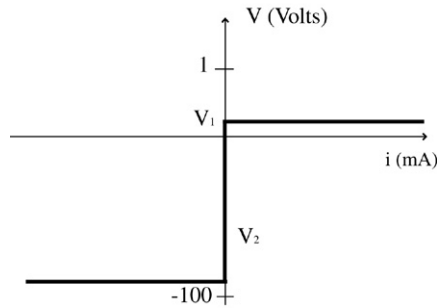
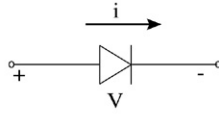

Fig. 1. Diode model.

Now, we hope that it is not sacrilege to think that there remains perhaps something like a small gap between the database and catalogs of electrical components and the catalogs of theorems that can be found in the set-valued mathematical literature. Our purpose in this paper is to try to build something like a small bridge over this gap.

More precisely, we will show that the approach of Moreau and Panagiotopoulos [31,37] constitutes a powerful key that can be used to write a precise and rigorous mathematical model describing the dynamics of circuits involving devices like diodes, diacs and thyristors.

2. Set-valued ampere–volt characteristics in electronics

Electrical devices are described in terms of ampere–volt characteristics. Experimental measures and mathematical models lead to a variety of graphs that may present vertical branches. The reader can find general descriptions of devices and ampere–volt characteristics either in the appropriate electronics literature or in electronics society catalogs available on the Net.

Example 1. The diode is a device that constitutes a rectifier which permits the easy flow of charges in one direction but restrains the flow in the opposite direction. Fig. 1 illustrates the ampere–volt characteristic of a practical diode model. There is a voltage point, called the knee voltage V_1 , at which the diode begins to conduct and a maximum reverse voltage, called the peak reverse voltage V_2 , that will not force the diode to conduct. When this voltage is exceeded, the depletion may breakdown and allow the diode to conduct in the reverse direction. Note that $|V_2| \gg |V_1|$. For example, for a practical diode, $V_1 \simeq 0.7$ V while $V_2 \simeq -70$ V.

Example 2. Fig. 2 illustrates a complete diode model which includes the effect of the natural resistance of the diode, called the bulk resistance, the reverse current I_R , the diode capacitance and the diffusion current. For example, the 10ETS. rectifier (SAFEIR series [7]) has been designed with $V_1 = 1.1$ V, $V_2 \in [-1600, -800]$ V, $I_R = 0.05$ mA and with a bulk resistance equal to 20 m Ω .

Example 3. A varactor (see Fig. 3) is a diode that is made to take advantage of the capacitance effect. A voltage controlled capacitance is useful in electronics tuning circuits such as in television tuners. The capacitance of the diode can be modified by varying the reverse bias across the diode. Thus, if the direct current control voltage is time dependent, so is the graph in Fig. 3.

Example 4. The Zener diodes are made to permit current to flow in the reverse direction if the voltage is larger than the rated breakdown or “Zener voltage” V_2 . For example, for a practical diode, $V_1 \simeq 0.7$ V and $V_2 = -7$ V. The Zener diode is (see Fig. 4) a good voltage regulator for maintaining a constant voltage regardless of minor variations in load

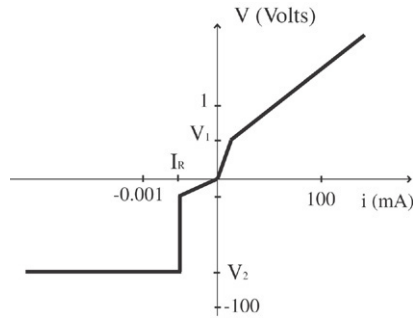

Fig. 2. Complete diode model.

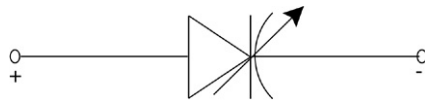

Fig. 3. Varactor.

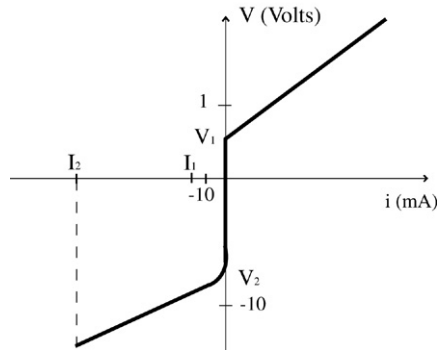
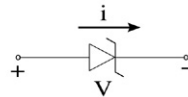

Fig. 4. Zener diode model.

current or input voltage. There is a current point I_1 , called the Zener knee current, which is the minimum value of the Zener current required to maintain voltage regulation and a maximum allowable value of Zener current I_2 . Currents above this value will damage or destroy the model.

Example 5. Bilateral trigger diacs are bidirectional thyristors designed to switch alternating current and trigger silicon controlled rectifiers and triacs. Fig. 5(a) and (b) illustrate typical voltage current characteristics of a diac. Here V_1 (resp. $V_2 = -V_1$) is the forward (resp. reverse) breakover voltage while I_1 (resp. $I_2 = -I_1$) is the forward (resp. reverse) breakover current. For example, for a practical trigger diac, $V_1 = 30$ V and $I_1 = 25$ μ A.

Example 6. Silicon controlled rectifiers are three-terminal devices designed for start/stop control circuit for a direct current motor, lamp, or other practical load. Fig. 6(a) and (b) illustrate the typical ampere-volt characteristic of a three-terminal silicon controlled rectifier for a given gate current I_G . Fig. 6(c) shows that the forward breakover voltage is a function of the cathode gate current I_G . Thus if I_G is time dependent, so is the graph describing the ampere-volt characteristic.

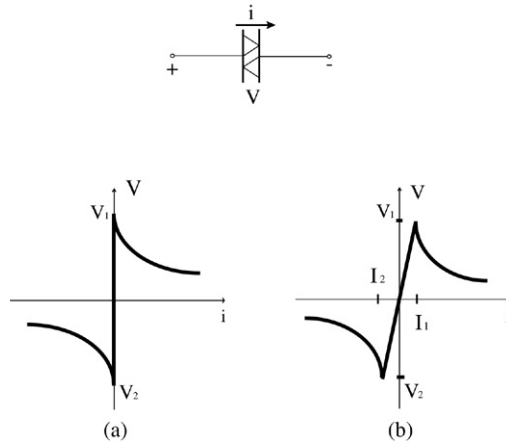

Fig. 5. Diac model.

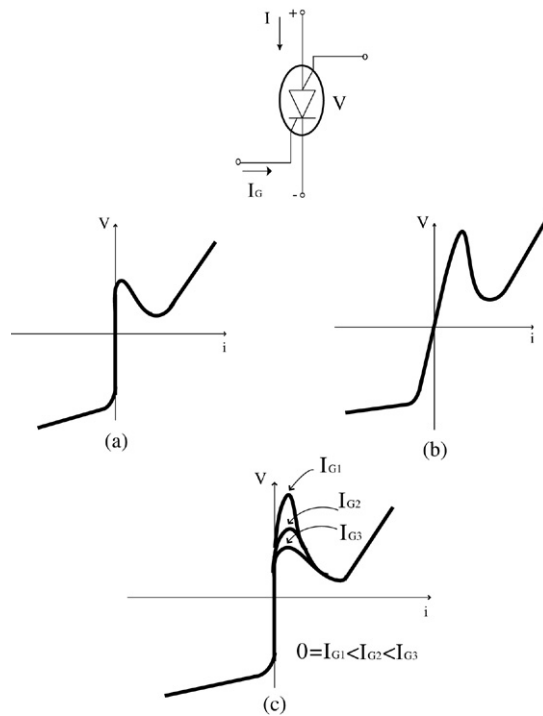

Fig. 6. Silicon controller rectifier.

The ampere–volt characteristics depicted above in Figs. 2–6 show that both monotone and non-monotone single-valued and set-valued graphs may be encountered in electronics.

Remark 1. Note that in the engineering literature, the ampere–volt characteristic of a device is usually depicted as a volt–ampere characteristic.

3. The approach of Moreau and Panagiotopoulos

The discussion above shows the interest of introducing a general model of an electrical device whose ampere–volt characteristic may present some finite vertical branches. Such a model is depicted in Fig. 7.

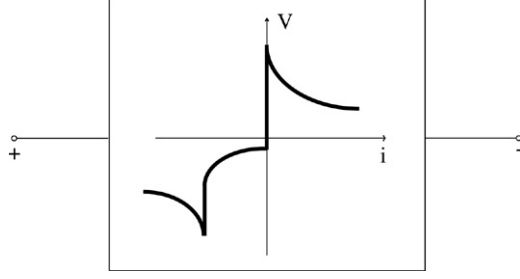

Fig. 7. Electrical device.

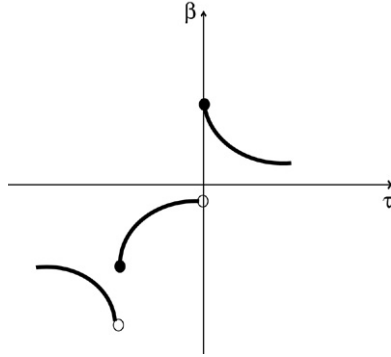

Fig. 8. Function β .

The first step of our mathematical treatment consists of proposing a mathematical relation that describes such a general possibly set-valued ampere–volt characteristic.

In fact, the approach for doing that exists in the literature and has been essentially developed in unilateral mechanics (see e.g. [15,22,23,32,34,36,38,39]). It has been introduced by Moreau [31] for the treatment of monotone set-valued graphs and then extended by Panagiotopoulos [37] for the treatment of general set-valued graphs including both monotone and non-monotone graphs. This approach is now used by most engineers to formulate concrete models for highly nonlinear phenomena in mechanics like adhesion, friction, unilateral contact, delamination, fracture, debonding, etc.

We may first write

$$V \in \mathcal{F}(i), \quad (i \in \mathbb{R})$$

for some set-valued function $\mathcal{F} : \mathbb{R} \rightrightarrows \mathbb{R}$.

In our framework, the approach of Moreau and Panagiotopoulos consists of introducing a possibly discontinuous function $\beta \in L_{\text{loc}}^{\infty}(\mathbb{R}; \mathbb{R})$ such that left limit $\beta(i^-)$ and right limit $\beta(i^+)$ exist for all $i \in \mathbb{R}$ and so that

$$\mathcal{F}(i) = [\min\{\beta(i^-), \beta(i^+)\}, \max\{\beta(i^-), \beta(i^+)\}], \quad (i \in \mathbb{R}). \quad (1)$$

For example, the function β depicted in Fig. 8 is deduced from the set-valued graph in Fig. 7.

Remark 2. Note that filling in the graph of a discontinuous function is a methodology which can be also traced back to Rauch [42] for PDE's.

Let us now introduce the function $j : \mathbb{R} \rightarrow \mathbb{R}$ through the formula

$$j(i) = \int_0^i \beta(\tau) d\tau, \quad (i \in \mathbb{R}). \quad (2)$$

Here $\beta \in L_{\text{loc}}^{\infty}(\mathbb{R}; \mathbb{R})$ and the function j is thus locally Lipschitz. Moreover, a fundamental result in set-valued analysis due to Chang (see e.g. [18] and Proposition 1.2.19 in [22]) ensures that

$$\partial_C j(i) = [\min\{\beta(i^-), \beta(i^+)\}, \max\{\beta(i^-), \beta(i^+)\}], \quad (i \in \mathbb{R}).$$

Here, for $i \in \mathbb{R}$, $\partial_C j(i)$ denotes Clarke's subdifferential (see e.g. [19]) of j at i , that is

$$\partial_C j(i) = \{w \in \mathbb{R} : j^0(i; v) \geq wv, \forall v \in \mathbb{R}\}$$

where

$$j_C^0(i; v) := \limsup_{w \rightarrow i, \lambda \downarrow 0} \frac{j(w + \lambda v) - j(w)}{\lambda}$$

denotes the generalized directional derivative of j at i . Then

$$\mathcal{F}(i) = \partial_C j(i), \quad (i \in \mathbb{R})$$

and the relation that models the ampere–volt characteristic reads

$$V \in \partial_C j(i), \quad (i \in \mathbb{R}). \tag{3}$$

The formula in (3) is a subdifferential relation allowing the use of various powerful mathematical tools of unilateral analysis (see e.g. [11,12,19,22,24,33,36]).

Roughly speaking, $\partial_C j$ results from the possibly discontinuous function β by “filling in the gaps”. In other rough words, j appears as a “primitive” of \mathcal{F} in the sense that the “derivative” (in the sense of Clarke) of j recovers the set-valued function \mathcal{F} .

Remark 3. Note that the function j in (2) is the unique function such that

$$\partial_C j(i) = [\min\{\beta(i^-), \beta(i^+)\}, \max\{\beta(i^-), \beta(i^+)\}], \quad (i \in \mathbb{R})$$

and

$$j(0) = 0.$$

3.1. VAP-admissible device and electrical superpotential

We will say that an electrical device is *VAP-admissible* provided that its ampere–volt characteristic can be written as in (1) for some function $\beta \in L_{\text{loc}}^{\infty}(\mathbb{R}; \mathbb{R})$ admitting left and right limits $\beta(i^-), \beta(i^+)$, for all $i \in \mathbb{R}$. Note that VAP stands for “volt–ampere–Panagiotopoulos”.

Remark 4. (i) All devices described in the previous section are VAP-admissible devices.

(ii) The ideal diode is described by the complementarity relations

$$V \leq 0, \quad i \geq 0, \quad Vi = 0,$$

that is the set-valued relation:

$$V \in \mathcal{F}(i) := \begin{cases} \emptyset & \text{if } i < 0 \\]-\infty, 0] & \text{if } i = 0 \\ 0 & \text{if } i > 0. \end{cases}$$

It is easy to remark that the ideal diode is not a VAP-admissible device. This fact does not really constitute a limitation of our approach for the analysis of non-regular circuits since the ideal diode does not exist as a concrete electrical device. Indeed, any existing diode presents a maximum reverse voltage and a peak reverse voltage (see Example 7) and such diode is VAP-admissible.

(iii) Circuits involving ideal diodes can be studied by means of tools from the theory of complementarity systems (see e.g. [20,26]). This approach has been the subject of recent works (see e.g. [28,16,17,35] and the references cited therein).

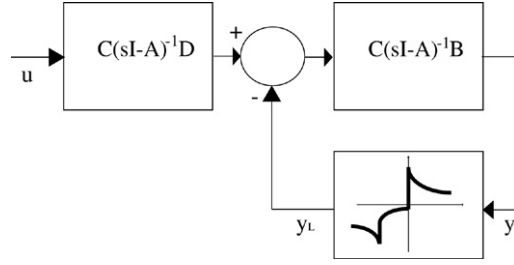

Fig. 9. Illustration of the circuit with a feedback branch.

The function j in (2) that defines the ampere–volt characteristic of a VAP-admissible device will be called the *electrical superpotential* of the device.

Remark 5. If the ampere–volt characteristic is time dependent, so are the functions β and j .

4. Non-regular circuits and systems

In this section, we introduce a general formalism whose study was initiated by Brogliato in [13] and [14]. We also refer the reader to [9,16,21] for some related recent work.

Let $A \in \mathbb{R}^{n \times n}$, $B \in \mathbb{R}^{n \times m}$, $C \in \mathbb{R}^{m \times n}$ and $D \in \mathbb{R}^{n \times p}$ be given matrices. Let $j : \mathbb{R} \times \mathbb{R}^m \rightarrow \mathbb{R}$ be a given mapping. It is assumed that $x \mapsto j(t, x)$ is locally Lipschitz for all $t \geq 0$.

Our aim is to introduce a system described by a transfer function

$$H(s) = C(sI - A)^{-1}B$$

and a feedback branch containing sector static nonlinearity as depicted in Fig. 9.

The feedback nonlinearity that describes the graph (y, y_L) is here defined by the model

$$y_L \in \partial_{C,2}j(\cdot, y).$$

Here, for $t \geq 0$ and $x \in \mathbb{R}^m$, $\partial_{C,2}j(t, x)$ denotes Clarke's subdifferential of $j(t, \cdot)$ with respect to the second variable at x , that is

$$\partial_{C,2}j(t, x) = \{w \in \mathbb{R}^m : j_{C,2}^0(t, x; v) \geq \langle w, v \rangle, \forall v \in \mathbb{R}^m\}, \quad (t \geq 0)$$

where

$$j_{C,2}^0(t, x; v) := \limsup_{w \rightarrow x, \lambda \downarrow 0} \frac{j(t, w + \lambda v) - j(t, w)}{\lambda}, \quad (t \geq 0)$$

and

$$\langle w, v \rangle := \sum_{i=1}^m w_i v_i.$$

Moreover, the system is driven by inputs Du for some given function

$$u : [0, +\infty[\rightarrow \mathbb{R}^p; \quad t \mapsto u(t).$$

The state-space equations of such a system are given by

$$\frac{dx}{dt}(t) = Ax(t) - By_L(t) + Du(t), \quad \text{a.e. } t \geq 0 \quad (4)$$

$$y(t) = Cx(t), \quad \forall t \geq 0, \quad (5)$$

and

$$y_L(t) \in \partial_{C,2}j(t, y(t)), \quad \text{a.e. } t \geq 0. \quad (6)$$

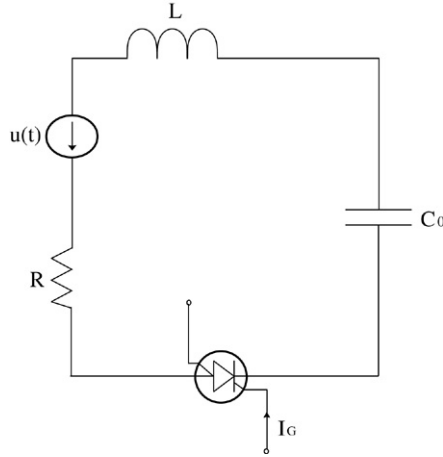

Fig. 10. Circuit of the Example 7.

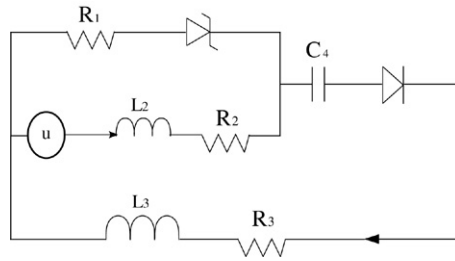

Fig. 11. Circuit of Example 8.

This framework is particularly useful for the study of non-regular circuits involving VAP-admissible devices.

Example 7. Let us consider the following dynamics that corresponds to the circuit depicted in Fig. 10:

$$\begin{pmatrix} \frac{dx_1}{dt} \\ \frac{dx_2}{dt} \end{pmatrix} = \overbrace{\begin{pmatrix} 0 & 1 \\ -\frac{1}{LC_0} & -\frac{R}{L} \end{pmatrix}}^A \begin{pmatrix} x_1 \\ x_2 \end{pmatrix} - \overbrace{\begin{pmatrix} 0 \\ -\frac{1}{L} \end{pmatrix}}^B y_L + \overbrace{\begin{pmatrix} 0 \\ \frac{1}{L} \end{pmatrix}}^D u, \quad y = \overbrace{\begin{pmatrix} 0 & -1 \end{pmatrix}}^C \begin{pmatrix} x_1 \\ x_2 \end{pmatrix}$$

and

$$y_L \in \partial_{C,2} j_{SCR}(\cdot, y)$$

where $R > 0$ is a resistor, $L > 0$ an inductor, $C_0 > 0$ a capacitor, u is the voltage supply, x_1 is the time integral of the current across the capacitance, x_2 is the current across the circuit, y_L is the voltage of the silicon controlled rectifier, j_{SCR} is the electrical superpotential of the silicon controlled rectifier. The time dependence of j_{SCR} is driven by the gate current I_G .

Example 8. Let us consider the following dynamics that corresponds to the circuit depicted in Fig. 11:

$$\begin{pmatrix} \frac{dx_1}{dt} \\ \frac{dx_2}{dt} \\ \frac{dx_3}{dt} \end{pmatrix} = \overbrace{\begin{pmatrix} 0 & 1 & 0 \\ -\frac{1}{L_3 C_4} & -\frac{(R_1 + R_3)}{L_3} & \frac{R_1}{L_3} \\ 0 & \frac{R_1}{L_2} & -\frac{(R_1 + R_2)}{L_2} \end{pmatrix}}^A \begin{pmatrix} x_1 \\ x_2 \\ x_3 \end{pmatrix} - \overbrace{\begin{pmatrix} 0 & 0 \\ \frac{1}{L_3} & \frac{1}{L_3} \\ -\frac{1}{L_2} & 0 \end{pmatrix}}^B \begin{pmatrix} y_{L,1} \\ y_{L,2} \end{pmatrix} + \overbrace{\begin{pmatrix} 0 \\ 0 \\ \frac{1}{L_2} \end{pmatrix}}^D u,$$

and

$$\begin{cases} y_{L,1} \in \partial_C j_D(-x_3 + x_2) \\ y_{L,2} \in \partial_C j_Z(x_2) \end{cases} \quad (7)$$

where $R_1 > 0$, $R_2 > 0$, $R_3 > 0$ are resistors, $L_2 > 0$, $L_3 > 0$ are inductors, $C_4 > 0$ is a capacitor, x_1 is the time integral of the current across the capacitor, x_2 is the current across the capacitor, x_3 is the current across the inductor L_2 and resistor R_2 , $y_{L,1}$ is the voltage of the Zener diode, $y_{L,2}$ is the voltage of the diode, j_Z is the electrical superpotential of the Zener diode and j_D is the electrical superpotential of the diode. Setting

$$y = \overbrace{\begin{pmatrix} 0 & 1 & -1 \\ 0 & 1 & 0 \end{pmatrix}}^C \begin{pmatrix} x_1 \\ x_2 \\ x_3 \end{pmatrix}$$

and defining the function $j_{ZD} : \mathbb{R}^2 \rightarrow \mathbb{R}$; $X \mapsto j_{ZD}(X)$ by the formula

$$j_{ZD}(X) = j_Z(X_1) + j_D(X_2),$$

we may write the relations in (7) equivalently as

$$y_L \in \partial_C j_{ZD}(Cx).$$

5. Mathematical formalism

Let $A \in \mathbb{R}^{n \times n}$, $B \in \mathbb{R}^{n \times m}$, $C \in \mathbb{R}^{m \times n}$ and $D \in \mathbb{R}^{n \times p}$ be given matrices.

Let $j : \mathbb{R} \times \mathbb{R}^m \rightarrow \mathbb{R}$ be a given mapping. It is assumed that $x \mapsto j(t, x)$ is locally Lipschitz for all $t \geq 0$.

Let $u : [0, +\infty[\rightarrow \mathbb{R}^p$; $t \mapsto u(t)$ be a given function. We suppose that

$$u \in L_{\text{loc}}^1(0, +\infty; \mathbb{R}^p).$$

For $x_0 \in \mathbb{R}^n$, we consider the problem $P(x_0)$: Find a function $x : [0, +\infty[\rightarrow \mathbb{R}^n$; $t \mapsto x(t)$ and a function $y_L : [0, +\infty[\rightarrow \mathbb{R}^m$; $t \mapsto y_L(t)$ such that

$$x \in C^0([0, +\infty[; \mathbb{R}^n), \quad (8)$$

$$By_L \in L_{\text{loc}}^1(0, +\infty; \mathbb{R}^n), \quad (9)$$

$$\frac{dx}{dt} \in L_{\text{loc}}^1(0, +\infty; \mathbb{R}^n), \quad (10)$$

$$x(0) = x_0, \quad (11)$$

$$\frac{dx}{dt}(t) = Ax(t) - By_L(t) + Du(t), \quad \text{a.e. } t \geq 0 \quad (12)$$

$$y(t) = Cx(t), \quad \forall t \geq 0, \quad (13)$$

and

$$y_L(t) \in \partial_{C,2} j(t, y(t)), \quad \text{a.e. } t \geq 0. \quad (14)$$

Let us now make the following key assumption:

(H) There exists a symmetric and invertible matrix $R \in \mathbb{R}^{n \times n}$ such that

$$R^{-2}C^T = B.$$

Note that $R^{-2} = (R^{-1})^2$. Using (12)–(14), we may consider the differential inclusion

$$\frac{dx}{dt} \in Ax - B\partial_{C,2} j(\cdot, Cx) + Du.$$

Setting $z = Rx$, we remark that

$$\begin{aligned} \frac{dx}{dt} &\in Ax - B\partial_{C,2}j(\cdot, Cx) + Du \\ &\Leftrightarrow R \frac{dx}{dt} \in RAR^{-1}Rx - RB\partial_{C,2}j(\cdot, CR^{-1}Rx) + RDu \\ &\Leftrightarrow \frac{dz}{dt} \in RAR^{-1}z - R^{-1}R^2B\partial_{C,2}j(\cdot, CR^{-1}z) + RDu \\ &\Leftrightarrow \frac{dz}{dt} \in RAR^{-1}z - R^{-1}C^T\partial_{C,2}j(\cdot, CR^{-1}z) + RDu. \end{aligned}$$

This allows us to consider, for $x_0 \in \mathbb{R}^n$, the problem $Q(x_0)$: Find a function $z : [0, +\infty[\rightarrow \mathbb{R}^n; t \mapsto z(t)$ such that

$$z \in C^0([0, +\infty[; \mathbb{R}^n), \quad (15)$$

$$\frac{dz}{dt} \in L^1_{\text{loc}}(0, +\infty; \mathbb{R}^n), \quad (16)$$

$$z(0) = Rx_0, \quad (17)$$

$$\frac{dz}{dt}(t) \in RAR^{-1}z(t) + RDu(t) - R^{-1}C^T\partial_{C,2}j(t, CR^{-1}z(t)), \quad \text{a.e. } t \geq 0. \quad (18)$$

Proposition 1. *Suppose that assumption (H) is satisfied. If (x, y_L) is a solution of problem $P(x_0)$ then $z = Rx$ is solution of problem $Q(x_0)$. Reciprocally, if z is a solution of problem $Q(x_0)$ then there exists a function y_L such that $(R^{-1}z, y_L)$ is a solution of problem $P(x_0)$.*

Proof. We have seen above that if (x, y_L) is a solution of problem $P(x_0)$ then $z = Rx$ is a solution of problem $Q(x_0)$. Suppose now that z is a solution of problem $Q(x_0)$. Then setting $x = R^{-1}z$, we see as above that

$$\frac{dx}{dt} \in Ax - B\partial_{C,2}j(\cdot, Cx) + Du.$$

It results that there exists a function $y_L \in \partial_{C,2}j(\cdot, Cx)$ such that

$$\frac{dx}{dt} = Ax - By_L + Du.$$

Note that

$$By_L = -\frac{dx}{dt} + Ax + Du \in L^1_{\text{loc}}(0, +\infty; \mathbb{R}^n).$$

Then we obtain the relations in (8)–(14) by setting

$$y = Cx. \quad \square$$

So, using assumption (H), we may reduce the study of problem $P(x_0)$ to that of problem $Q(x_0)$ which can be investigated by means of mathematical tools from set-valued analysis, variational and hemivariational inequality theory (see e.g. [10–12,19,22,24,25,33,34,36,38,39]).

Remark 6. Let us set

$$L = CR^{-1}.$$

If z is a solution of problem $Q(x_0)$ then z satisfies the hemivariational inequality

$$\left\langle \frac{dz}{dt}(t) - RAR^{-1}z(t) - RDu(t), v \right\rangle + j_{C,2}^0(t, Lz(t); Lv) \geq 0, \quad \forall v \in \mathbb{R}^n, \text{ a.e. } t \geq 0.$$

Indeed, from (18), we deduce that

$$\frac{dz}{dt} - RAR^{-1}z - RDu(t) = -L^T w$$

for some function w satisfying

$$j_{C,2}^0(t, Lz; y) \geq \langle w, y \rangle, \quad \forall y \in \mathbb{R}^m, \text{ a.e. } t \geq 0.$$

Thus

$$j_{C,2}^0(t, Lz; Lv) \geq \langle w, Lv \rangle, \quad \forall v \in \mathbb{R}^n, \text{ a.e. } t \geq 0$$

and thus

$$j_{C,2}^0(t, Lz; Lv) \geq \langle L^T w, v \rangle, \quad \forall v \in \mathbb{R}^n, \text{ a.e. } t \geq 0$$

from which we deduce that

$$\left\langle \frac{dz}{dt}(t) - RAR^{-1}z(t) - RDu(t), v \right\rangle + j_{C,2}^0(t, Lz(t); Lv) \geq 0, \quad \forall v \in \mathbb{R}^n, \text{ a.e. } t \geq 0.$$

6. Assumption (H) and the Kalman–Yakubovich–Popov lemma

Let $A \in \mathbb{R}^{n \times n}$, $B \in \mathbb{R}^{n \times m}$ and $C \in \mathbb{R}^{m \times n}$. One says that the representation (A, B, C) is minimal provided that (A, B) is controllable and (A, C) is observable, i.e. the matrices $(BAB A^2 B \dots A^{n-1} B)$ and $(C C A C A^2 \dots C A^{n-1})^T$ have full rank.

Let us now consider the real, rational matrix-valued transfer function $H : \mathbb{C} \rightarrow \mathbb{C}^{m \times m}$ given by

$$H(s) = C(sI_n - A)^{-1}B. \quad (19)$$

Definition 1. One says that H is positive real if

- H is analytic in $\mathbb{C}^+ := \{s \in \mathbb{C} : \text{Re}[s] > 0\}$,
- $H(s) + H^T(\bar{s})$ is positive semi-definite for all $s \in \mathbb{C}^+$,

where \bar{s} is the conjugate of s .

The following result is called Kalman–Yakubovich–Popov lemma [27,40,43] (see also e.g. [29,41]).

Lemma 1. *Let (A, B, C) be a minimal realization and let H be defined in (19). The transfer function matrix H is positive real if and only if there exist a symmetric and positive definite matrix $P \in \mathbb{R}^{n \times n}$ and a matrix $L \in \mathbb{R}^{n \times m}$ such that*

$$\begin{aligned} PA + A^T P &= -LL^T \\ PB &= C^T. \end{aligned} \quad (20)$$

So, if the realization (A, B, C) is minimal and the transfer function H is positive real then there exists a symmetric and positive definite matrix $P \in \mathbb{R}^{n \times n}$ and a matrix $L \in \mathbb{R}^{n \times m}$ such that $PA + A^T P = -LL^T$ and $PB = C^T$. Choosing R as the symmetric square root of P , i.e. $R = R^T$, R positive definite and $R^2 = P$, we see that $B^T R^2 = C$ and thus

$$R^{-2}C^T = B.$$

It results that assumption (H) holds.

Note also that, for all $x \in \mathbb{R}^n$, we have

$$\begin{aligned} \langle RAR^{-1}x, x \rangle &\stackrel{z=R^{-1}x}{=} \langle RAz, Rz \rangle = \langle Az, R^2z \rangle \\ &= \langle Az, Pz \rangle = \frac{1}{2} \langle (PA + A^T P)z, z \rangle = -\frac{1}{2} \langle LL^T z, z \rangle \leq 0. \end{aligned}$$

It results that the matrix RAR^{-1} is negative semi-definite.

Example 9. Let us here consider the example discussed in Example 7. It is easy to check that

$$\text{rank}\{(B \ A \ B)\} = \text{rank}\{(C \ C \ A)^T\} = 2$$

and a simple computation shows that the transfer function

$$H(s) = C(sI - A)^{-1}B = \frac{C_0s}{LC_0s^2 + RC_0s + 1}$$

is positive real. The existence of a matrix R that satisfies condition (H) is thus a consequence of the Kalman–Yakubovic–Popov lemma. Note that the matrix

$$R = \begin{pmatrix} \frac{1}{\sqrt{C_0}} & 0 \\ 0 & \sqrt{L} \end{pmatrix}$$

is convenient.

Example 10. Let us here consider the example discussed in Example 8. It is easy to see that

$$\text{rank}\{(B \ AB \ A^2B)\} = \text{rank}\{(C \ C \ A \ C \ A^2)^T\} = 3$$

and a simple computation shows that the transfer function

$$H(s) = C(sI - A)^{-1}B = \frac{1}{D(s)} \begin{pmatrix} s^2C_4L_3 + s^2C_4L_2 + sC_4R_2 + sC_4R_3 + 1 & \frac{C_4L_3}{L_2}s(sL_2 + R_2) \\ C_4s(sL_2 + R_2) & \frac{C_4L_3}{L_2}s(sL_2 + R_1 + R_2) \end{pmatrix},$$

where

$$D(s) = s^3C_4L_3L_2 + s^2C_4L_3R_1 + s^2C_4L_3R_2 + s^2C_4R_1L_2 + sC_4R_1R_2 + s^2C_4R_3L_2 + sC_4R_3R_1 + sC_4R_3R_2 + sL_2 + R_1 + R_2,$$

is positive real. The existence of a matrix R that satisfies condition (H) is thus here also a consequence of the Kalman–Yakubovic–Popov lemma. A simple computation shows that the matrix

$$R = \begin{pmatrix} \frac{1}{\sqrt{C_4}} & 0 & 0 \\ 0 & \sqrt{L_3} & 0 \\ 0 & 0 & \sqrt{L_2} \end{pmatrix}$$

is convenient.

7. Conclusion

We have given in a rigorous and precise way the steps one has to follow in order to get a mathematical model that can be used to describe the dynamics of a circuit involving devices like diodes and thyristors.

We have seen that provided that some structural condition (H) is satisfied, then it is possible to reduce the mathematical model to a set-valued differential system of the form

$$\frac{dz}{dt} \in RAR^{-1}z - R^{-1}C^T \partial_{C,2}j(\cdot, CR^{-1}z) + RDu. \quad (21)$$

The matrix RAR^{-1} is negative semi-definite and the set-valued part of the model, i.e. $R^{-1}C^T \partial_{C,2}j(\cdot, CR^{-1}\cdot)$, is endowed with the nice properties of the subdifferential of Clarke. This allows the use of various powerful mathematical results from set-valued and unilateral analysis.

Some qualitative and stability results applicable to the model in (21) with j convex can be found in [9,13,16,21]. The non-convex case will be the subject of a future work.

References

- [1] Electro-principles I, ETEC 1120. <http://www.technology.niagarac.on.ca>.
- [2] Electronic devices and circuits, engineering sciences 154, Diode i–v characteristics. <http://people.deas.harvard.edu>.
- [3] Varactor diode, American microsemiconductor. <http://www.americanmicrosemi.com>.
- [4] Thyristors, All about circuits. <http://www.allaboutcircuits.com>.
- [5] Bilateral trigger diacs, thyristor product catalog, Teccor electronics. <http://www.teccor.com>.
- [6] Triacs, silicon bidirectional thyristors, On semiconductor. <http://onsemi.com>.
- [7] 10ETS. SAFEIR series, Bulletin 12120 rev. A 07/97. <http://www.digchip.com>.
- [8] Voltage regulator diodes. <http://www.datasheetcatalog.com/>.
- [9] S. Adly, D. Goeleven, A stability theory for second-order nonsmooth dynamical systems with applications to friction problems, *Journal de Mathématiques Pures et Appliquées* 83 (2004) 17–51.
- [10] J.P. Aubin, A. Cellina, *Differential Inclusions*, Springer-Verlag, Berlin, 1984.
- [11] H. Brézis, Problèmes unilatéraux, *Journal de Mathématiques Pures et Appliquées* 51 (1972) 1–168.
- [12] H. Brézis, *Opérateurs Maximaux Monotones et Semigroupes de Contractions dans les Espaces de Hilbert*, North-Holland Publ. Co., Amsterdam, American Elsevier Publ. Co., New York, 1972.
- [13] B. Brogliato, Absolute stability and the Lagrange–Dirichlet theorem with monotone multivalued mappings, *Systems and Control Letters* 51 (2004) 343–353.
- [14] B. Brogliato, Some perspectives on the analysis and control of complementarity systems, *IEEE Transactions on Automatic Control* 48 (2003) 918–935.
- [15] B. Brogliato, *Nonsmooth Mechanics*, Springer-Verlag, London, 1999.
- [16] B. Brogliato, D. Goeleven, The Krakovskii–LaSalle invariance principle for a class of unilateral dynamical systems, *Mathematics of Control Signals and Systems* 17 (2005) 57–76.
- [17] K. Camlibel, W.P.M.H. Heemels, H. Schumacher, On linear passive complementarity systems, *European Journal of Control* 8 (2002) 220–237.
- [18] K.C. Chang, Variational methods for non-differentiable functionals and their applications to partial differential equations, *Journal of Mathematical Analysis and Application* 80 (1981) 102–129.
- [19] F.H. Clarke, *Optimization and Nonsmooth Analysis*, Wiley, New York, 1983.
- [20] F. Facchinei, J.-S. Pang, *Finite Dimensional Variational Inequalities and Complementarity Problems*, Springer-Verlag, Berlin, 2003.
- [21] D. Goeleven, B. Brogliato, Stability and instability matrices for linear evolution variational inequalities, *IEEE Transactions on Automatic Control* 49 (2004) 521–534.
- [22] D. Goeleven, D. Motreanu, Y. Dumont, M. Rochdi, *Variational and Hemivariational Inequalities — Theory, Methods and Applications. vol. 1: Unilateral Analysis and Unilateral Mechanics*, Kluwer Academic Publishers, Boston, 2003.
- [23] D. Goeleven, D. Motreanu, *Variational and Hemivariational Inequalities — Theory, Methods and Applications. vol. 2: Unilateral Problems and Unilateral Mechanics*, Kluwer Academic Publishers, Boston, 2003.
- [24] L. Gorniewicz, Topological approach to differential inclusions, in: A. Granas, M. Frigon (Eds.), *Topological Methods in Differential Equations and Inclusions*, Kluwer Academic Publishers, Dordrecht, Boston, London, 1995, pp. 129–190.
- [25] S.C. Hu, N.S. Papageorgiou, *Handbook of Set-Valued Analysis*, Kluwer Academic Publishers, Boston, 1999.
- [26] G. Isac, Complementarity Problems, in: *Lecture Notes in Mathematics*, vol. 1528, Springer-Verlag, Heidelberg, 1993.
- [27] R.E. Kalman, Lyapunov functions for the problem of Lur’e in automatic control, *Proceedings of the National Academy of Sciences* 49 (1963) 201–205.
- [28] D. Leenaerts, W.M.G. van Bokhoven, *Piecewise Linear Modeling and Analysis*, Kluwer Academic Publishers, Norwell, MA, USA, 1998.
- [29] B. Brogliato, R. Lozano, B. Maschke, O. Egeland, *Dissipative Systems Analysis and Control. Theory and Applications*, 2nd ed., Springer-Verlag, London, 2006.
- [30] J. Millman, C.C. Halkias, *Integrated Electronics*, McGraw-Hill Kogakusha LTD, Sydney, 1985.
- [31] J.J. Moreau, La notion du surpotentiel et les Liaisons unilatérales on elastostatique, *Comptes Rendus de l’Académie des Sciences Paris* 167A (1968) 954–957.
- [32] J.J. Moreau, P.D. Panagiotopoulos (Eds.), *Nonsmooth Mechanics and Applications*, in: CISM, vol. 302, Springer-Verlag, Wien, 1988.
- [33] G. Morosanu, *Nonlinear Evolution Equation and Applications*, D. Reidel Publishing Company, Dordrecht, 1988.
- [34] D. Motreanu, P.D. Panagiotopoulos, *Minimax Theorems and Qualitative Properties of the Solutions of Hemivariational Inequalities*, Kluwer, Boston, 1999.
- [35] Y. Murakami, A Method for the formulation and solution of circuits composed of switches and linear RLC networks, *IEEE Transactions on Circuits and Systems—I* 49 (2002) 315–327.
- [36] Z. Naniewicz, P.D. Panagiotopoulos, *The Mathematical Theory of Hemivariational Inequalities and Applications*, Marcel Dekker, New York, 1995.
- [37] P.D. Panagiotopoulos, Non-convex superpotentials in the sense of F.H. Clarke and applications, *Mechanics Research Communications* 8 (1981) 335–340.
- [38] P.D. Panagiotopoulos, *Inequality Problems in Mechanics and Applications, Convex and Nonconvex Energy Functions*, Birkhäuser, Basel, 1985.
- [39] P.D. Panagiotopoulos, *Hemivariational Inequalities. Applications in Mechanics and Engineering*, Springer-Verlag, Berlin, Heidelberg, NY, 1993.
- [40] V.M. Popov, Absolute stability of nonlinear systems of automatic control, *Automation and Remote Control* 22 (1962) 857–875.
- [41] A. Rantzer, On the Kalman–Yakubovich–Popov lemma, *Systems and Control Letters* 28 (1996) 7–10.

- [42] J. Rauch, Discontinuous semilinear differential equations and multiple valued maps, *Proceedings of the American Mathematical Society* 64 (1977) 277–282.
- [43] V.A. Yakubovich, Solution of certain matrix inequalities in the stability theory of nonlinear control systems, *Doklady Akademii Nauk SSSR* 143 (1962) 1304–1307.