

**Membrane-assisted extractive fermentation for  
the production of biobased molecules: towards  
bioprocess intensification**

**Marwen Moussa**, Claire Saulou-Bérion, Florent Allais, Andreia Teixeira, Violaine Athès, Henry-Eric Spinnler

**Joint Unit “Food Process Engineering and Microbiology”**, INRA-AgroParisTech, Grignon, France

**Chair of Industrial Agro-Biotechnology– AgroParisTech**, Reims, France

# AgroParisTech – general facts



Institut national  
agronomique  
Paris-Grignon



ENGREF



ensia

AgroParisTech is the result of the merging of 3 Graduate Institutes in Science and Engineering dating back to the 19th century

1826

1824

1893



*Institute of technology for life, food and environmental sciences*

*Founded on January 1<sup>st</sup> 2007*

[www.agroparistech.fr](http://www.agroparistech.fr)



8 campuses



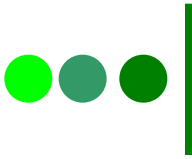

# Our 8 campuses nationwide

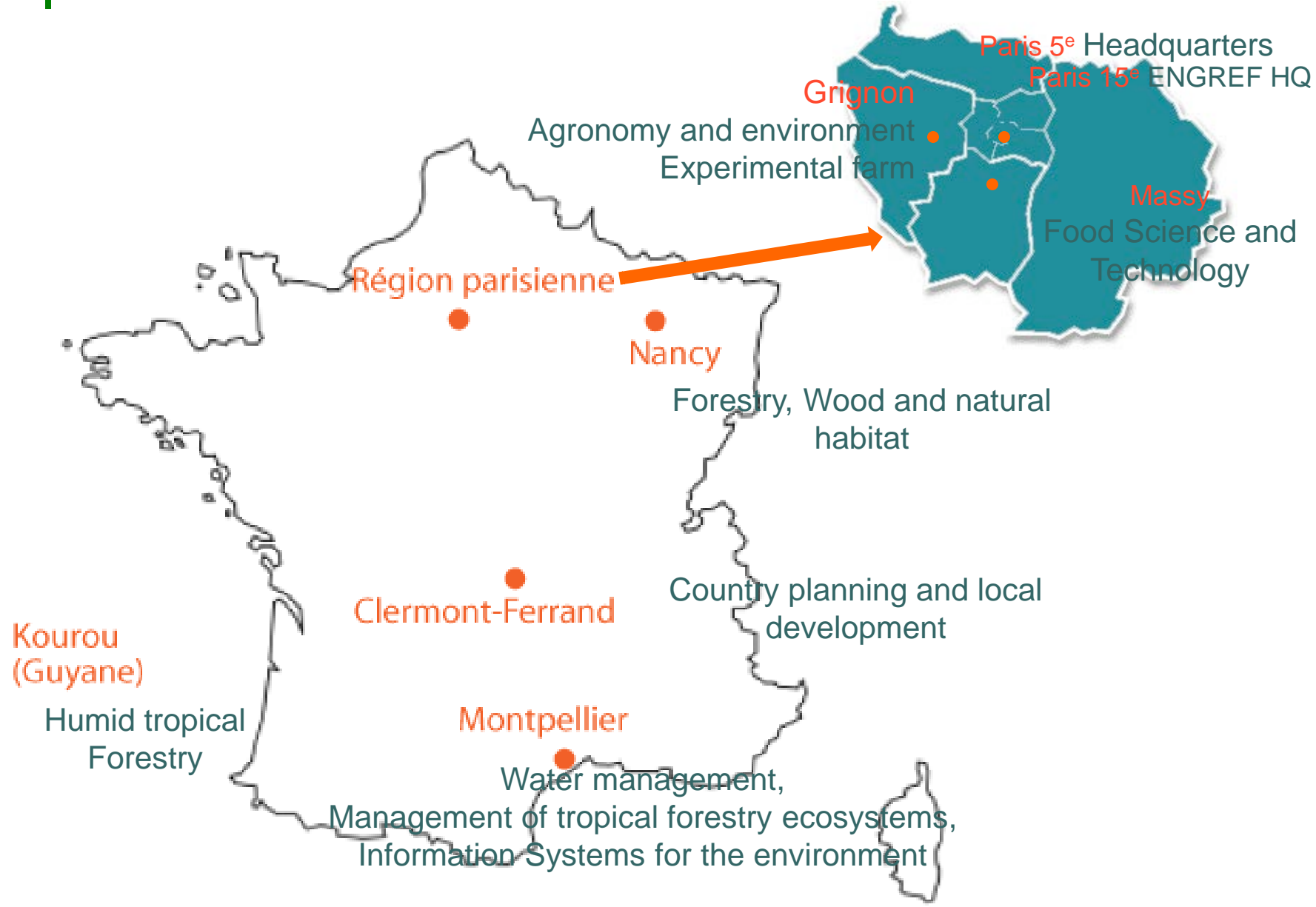

### Key Figures :

- 2 000 students including 450 PhD students
- 230 academic staff
- 300 researchers
- 39 research laboratories

AgroParisTech is deeply involved in Research with its 5 departments :

- Agronomy, Forestry, Water and Environment
- Life Science and Health
- **Science and engineering for Food and Bioproducts**
- Modelling: Mathematics, Informatics and Physics
- Social Sciences, Economics and Management

# ●●● | Research Unit: Food Process Engineering and Microbiology

→ Research and teaching missions related to the engineering of agricultural, food and biological products transformations

→ Joint Research Unit between INRA & AgroParisTech

Permanent staff : About 65 members (35 Scientists, 15 Technicians, 15 PhD & postdocs)  
4 multidisciplinary research teams  
5 support platforms

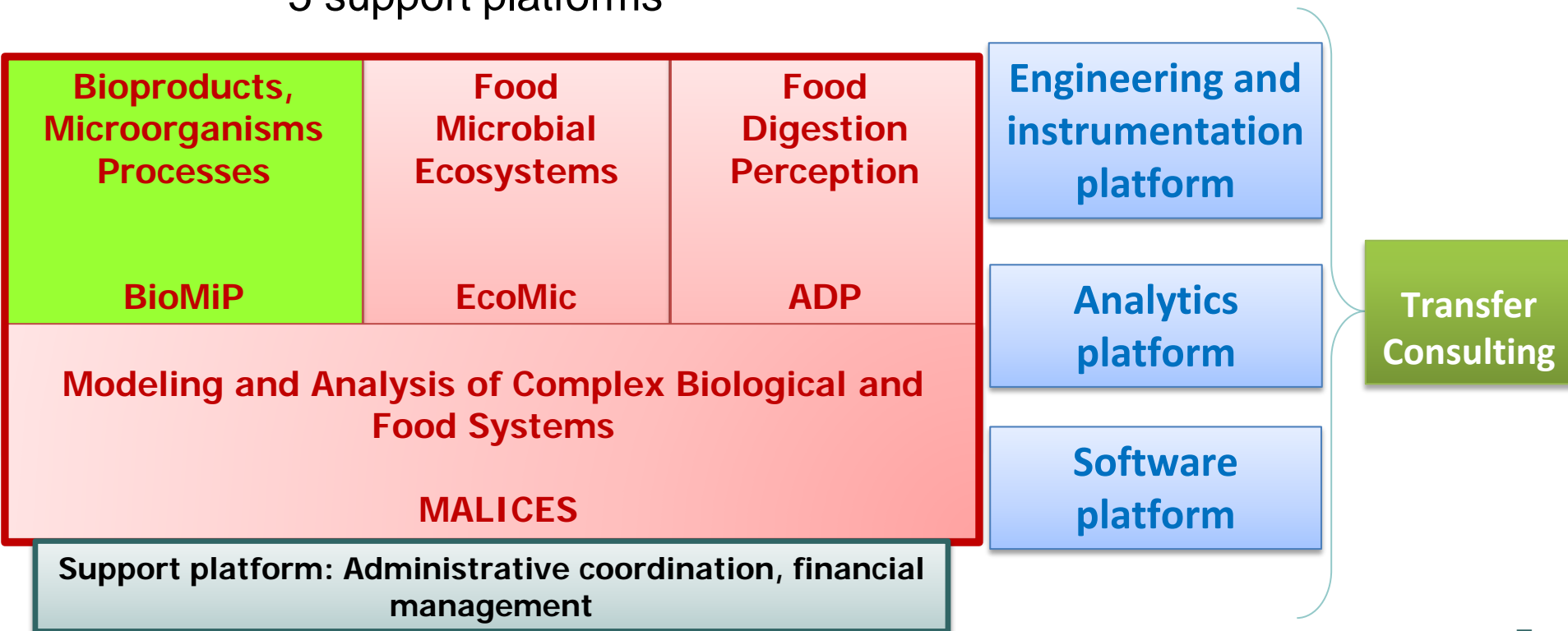

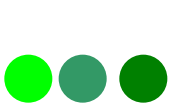

## Integrated Approach

Scales of study

Molecular

Cellular

Population

Medium-Matrix

Process

System

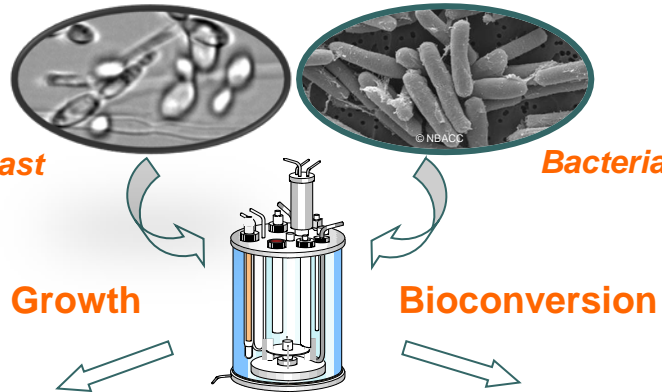

Stabilization



Freeze drying  
Freezing  
... Drying



Micro-organism's physiology  
Process operating conditions

Extractive Bioconversion

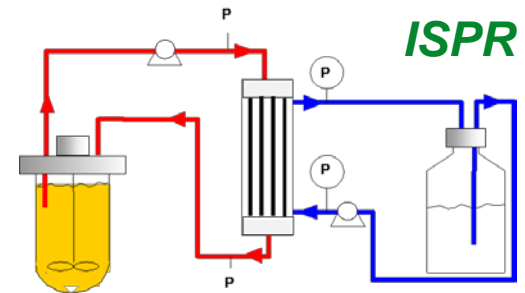

👍 Optimized bioprocesses

👍 Improved / stabilized functionalities



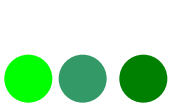

Belongs to the European Institute of Biorefinery, Pomacle

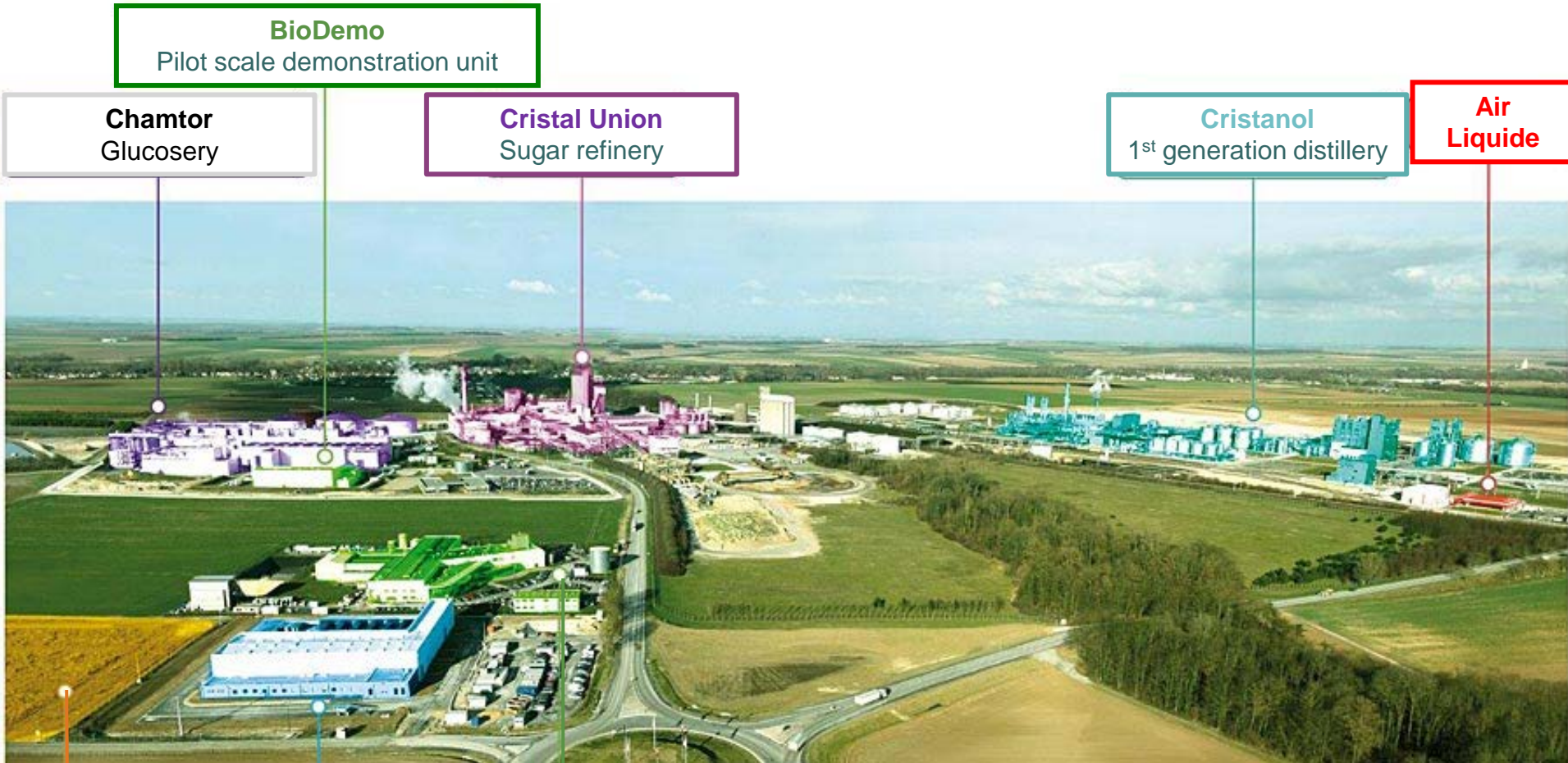

**BioDemo**  
Pilot scale demonstration unit

**Chamtor**  
Glucosery

**Cristal Union**  
Sugar refinery

**Cristanol**  
1<sup>st</sup> generation distillery

**Air Liquide**

**Procethol 2G – Futurol**  
2<sup>nd</sup> generation biofuels  
Pilot scale demonstration unit

**ARD** Private Research Centre  
**Soliance** Biobased cosmetics  
**Wheataleo** Biobased surfactants

**CEBB (European Center of  
Biotechnology and Bioeconomy)**  
Public Research Center

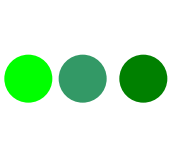

- ◆ Valorization of **agro-resources** and **byproducts streams**
- ◆ **Synthesis** and/or **purification** of new and value-added molecules
- ◆ **Substitution** of petroleum-based molecules → **Biobased molecules**

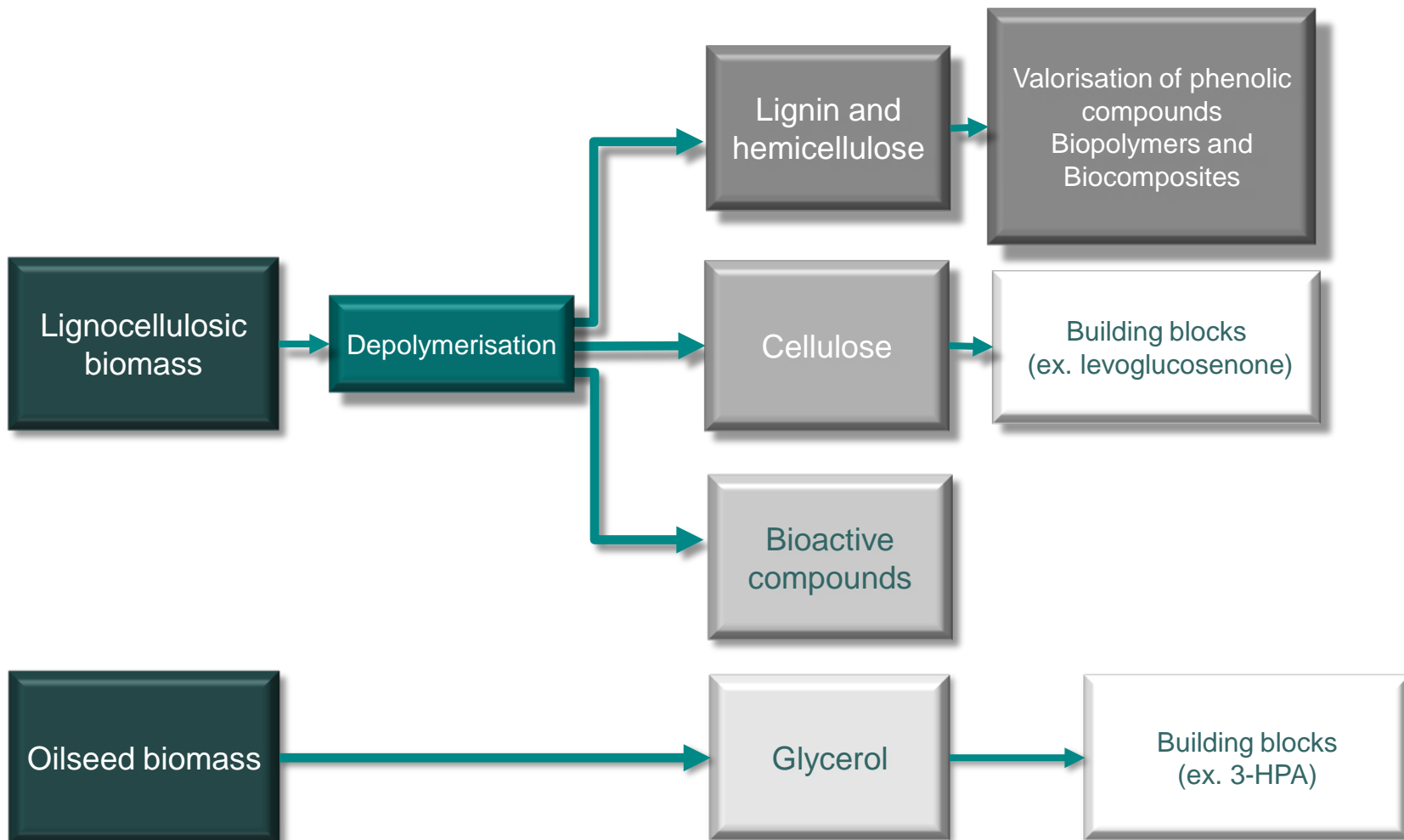



Prof. C. BEAL



Prof. F.  
ALLAIS



Prof. V.  
ATHES



Prof. H.E.  
SPINLER



Ass. Prof. C.  
SAULOU-BERION



Prof. M. BOUIX



PhD Student  
F. CHEMARIN

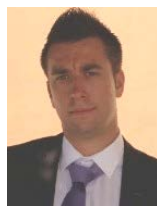

PhD Student  
G. BURGE



Msc. Student  
R. BOUNADER



Msc. Student  
M. CHADNI



Ing. A.  
FLOURAT



Ing. B. POLLET



Tech. J.  
DELETTRE



Ing. S.  
GHORBAL



PhD Student  
A. KALANTARI

## the team

# Downstream processing in biorefining and white biotechnology

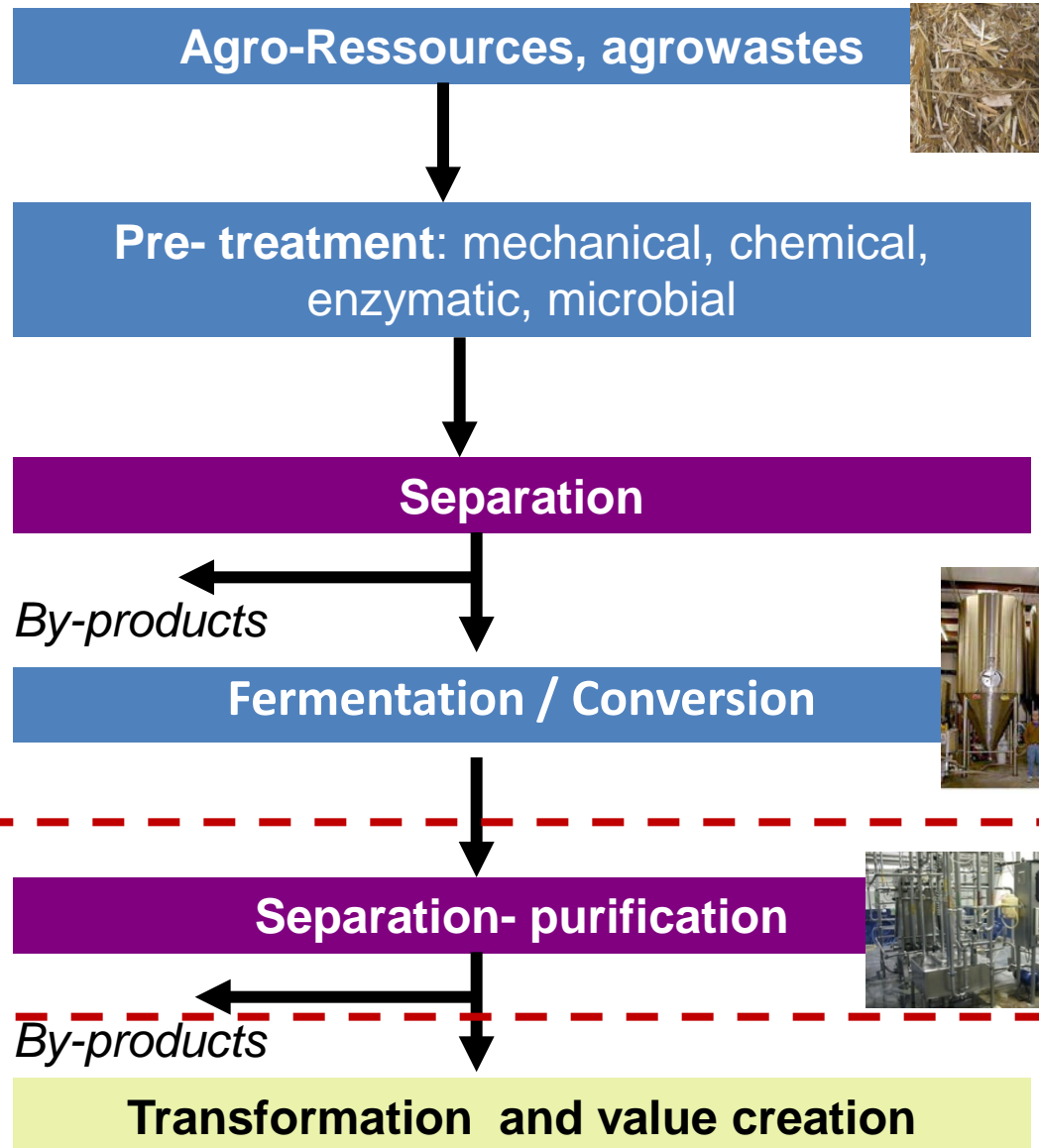
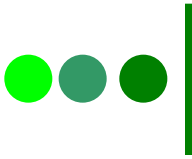

**Separation : 40 to 70% of investment and operating costs in bio-industries\***

\*Ramaswamy et al., 2013  
Humphrey et Keller, 2001

# Downstream processing in biorefining and white biotechnology

## Obtaining a bio-based molecule:

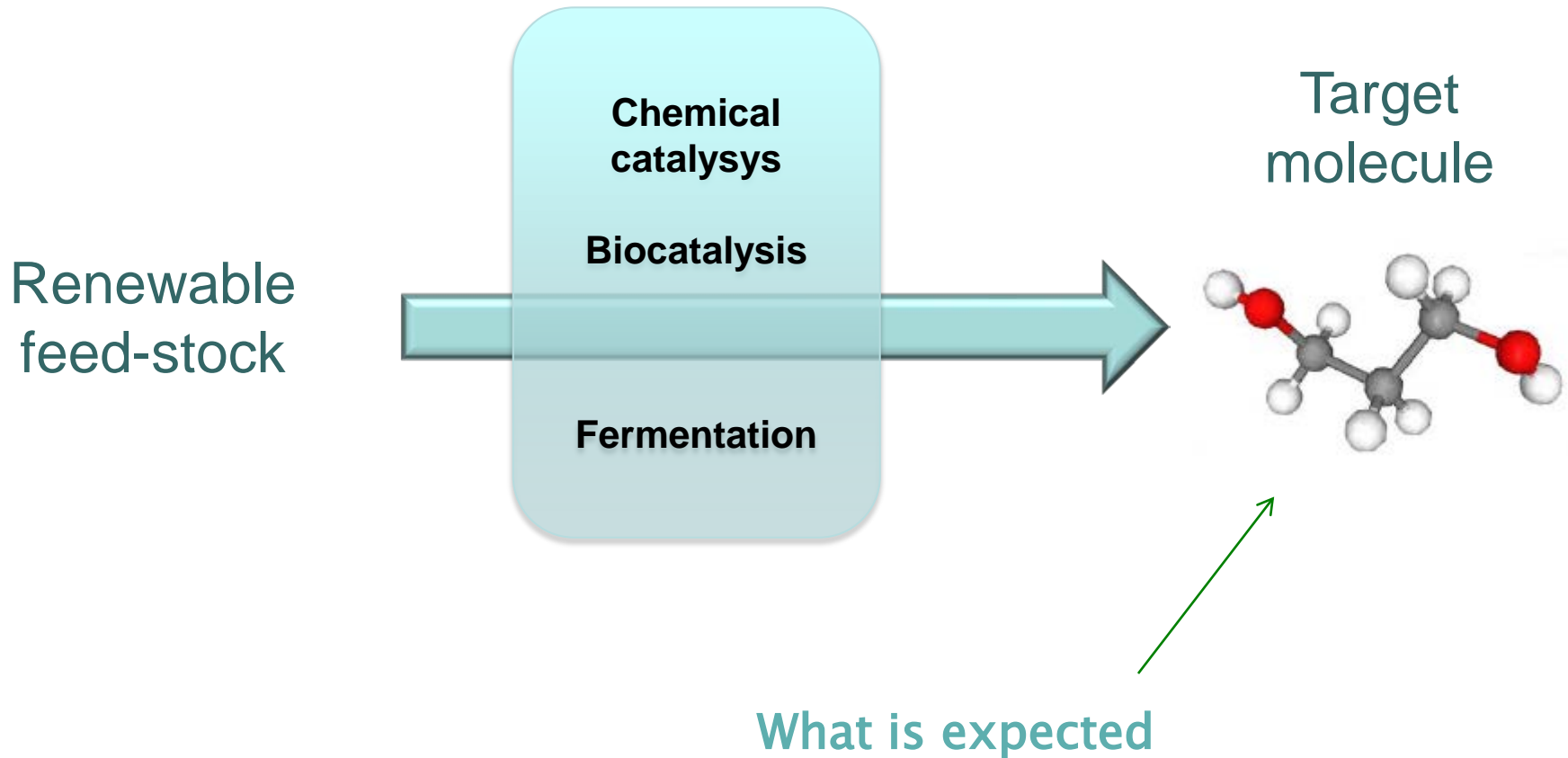

# Downstream processing in biorefining and white biotechnology

## Obtaining a bio-based molecule:

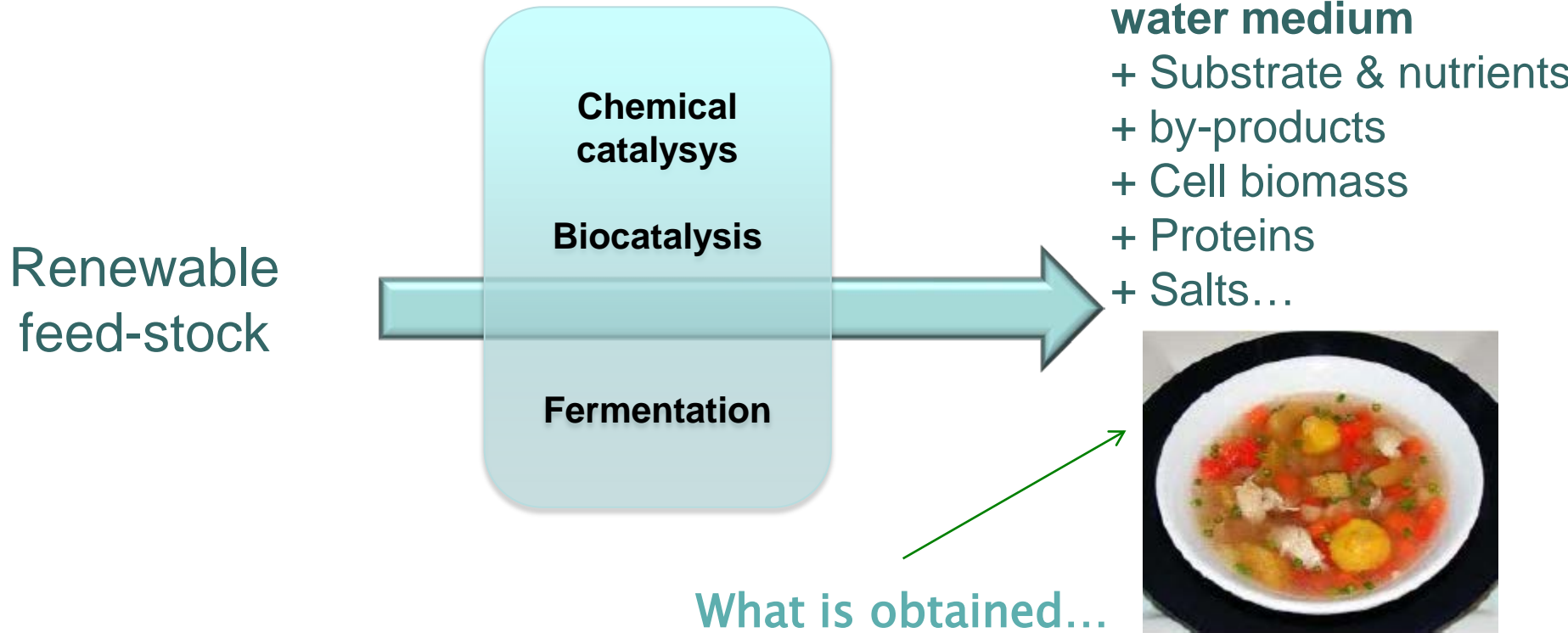

Need for selective processes, adapted to complex media

Need for intensification through process integration



# Integrated fermentation and separation for process intensification

**Highlight 1: Pervaporation and vapor permeation for the *in situ* recovery and purification of bio-alcohols**

**Highlight 2: Membrane contactors for the *In situ* reactive extraction of organic acids**



# Integrated fermentation and separation for process intensification

**Highlight 1: Pervaporation and vapor permeation for the *in situ* recovery and purification of bio-alcohols**

**Highlight 2: Membrane contactors for the *In situ* reactive extraction of organic acids**



# Biobutanol conventional process

Based on several classical distillation steps

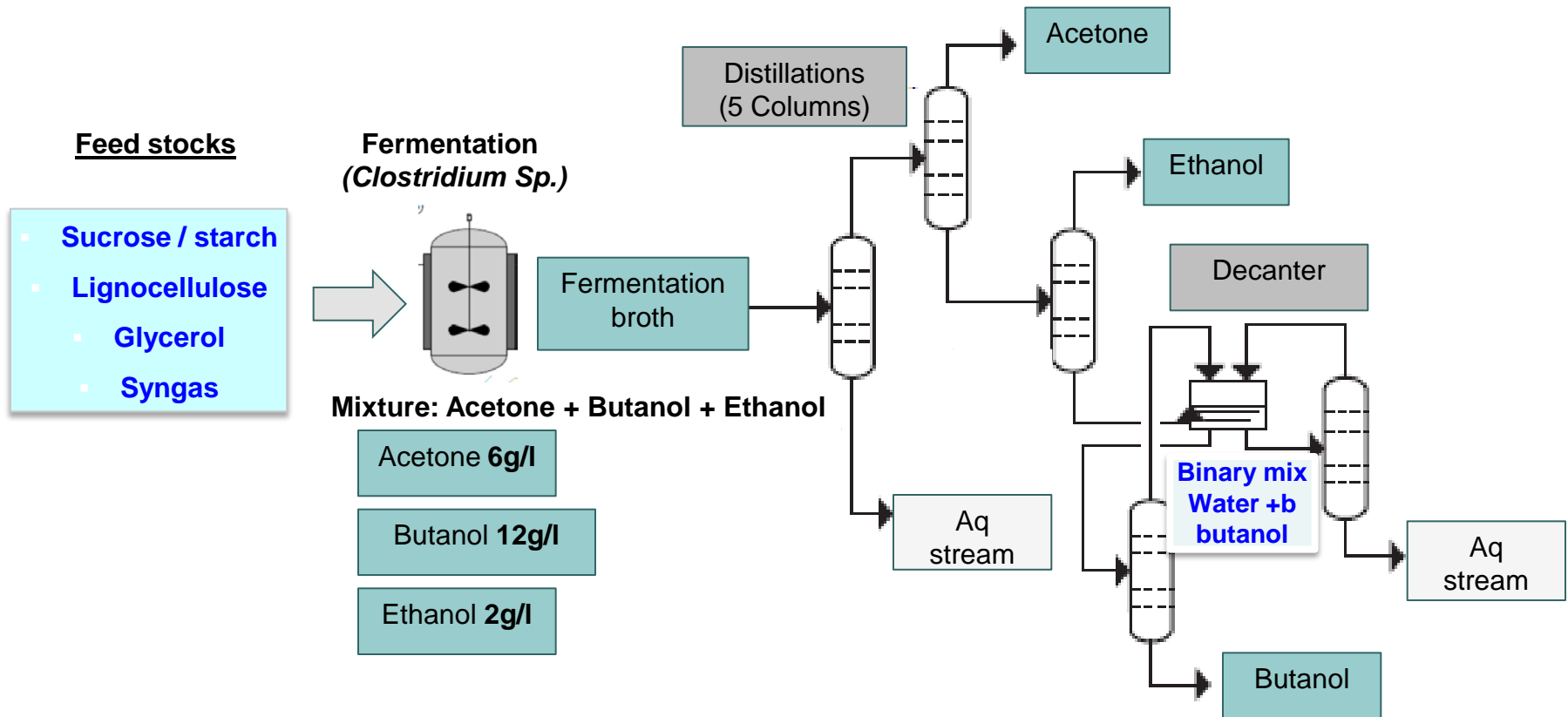

High energy consumption

High water footprint

Non-flexible process

# Alternative process

## Basic principles :

### Pervaporation (PV) vs VP (Vapor permeation)

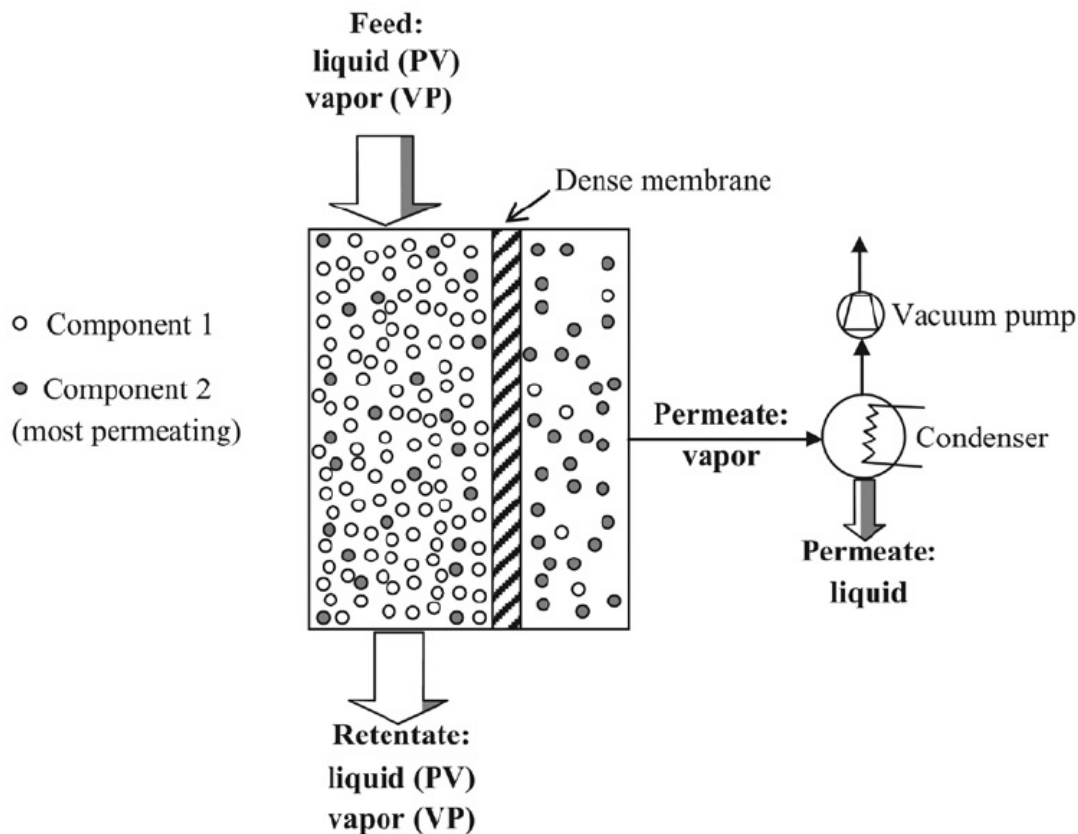

Schematic Diagram of PV and VP Principles where a Vacuum Pump is Operating on the Permeate Side

# Alternative process

ISPR of ABE using hydrophobic pervaporation: proof of concept

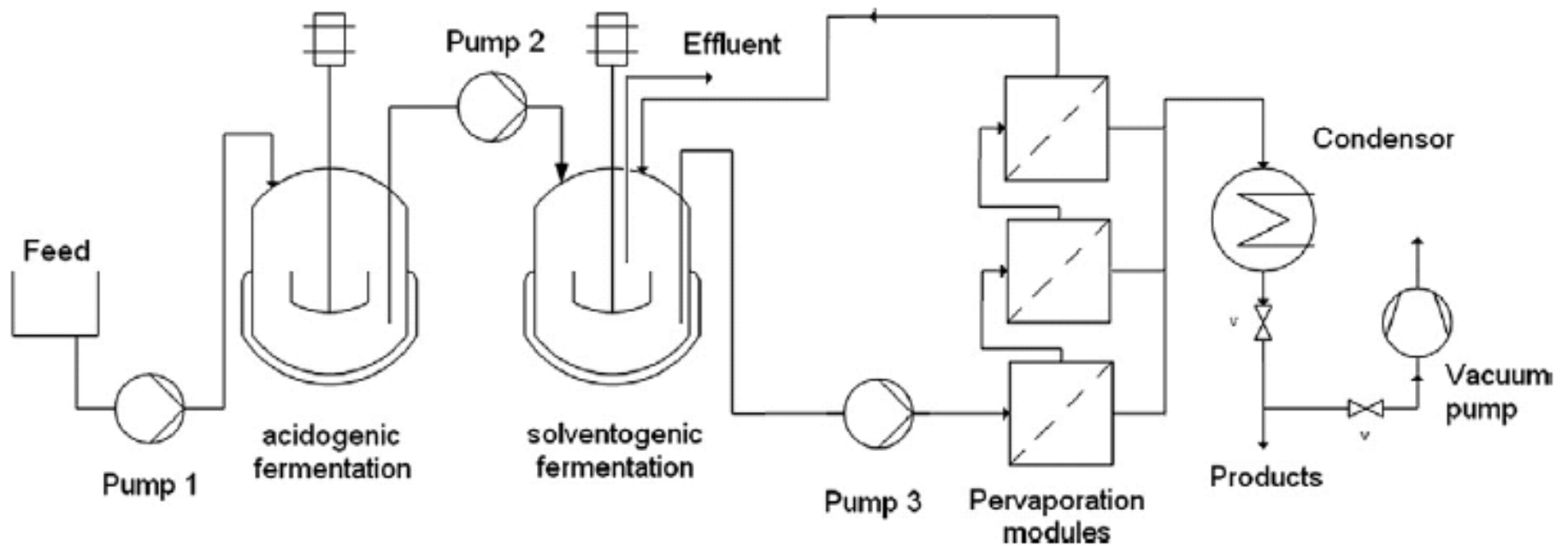
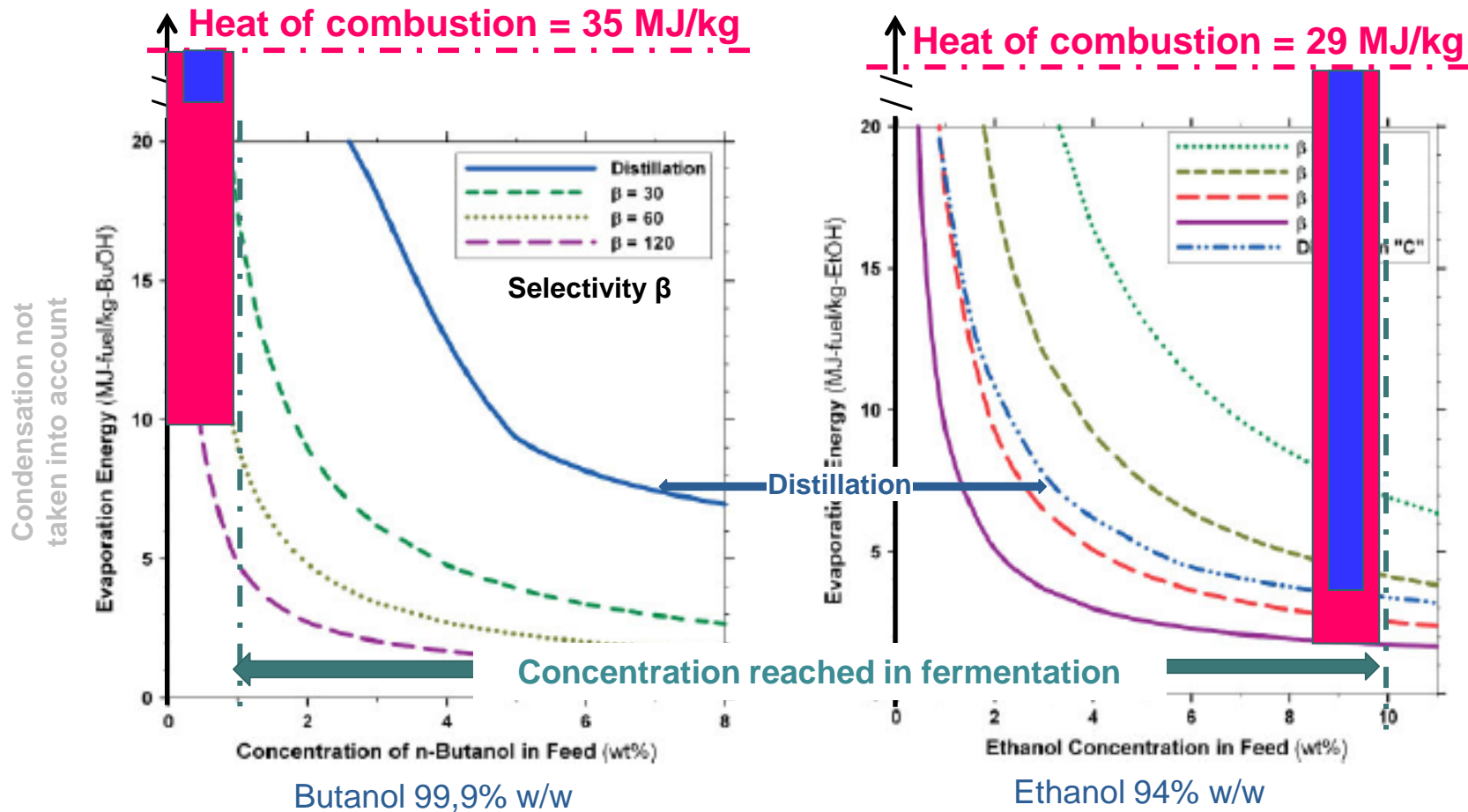

Fig. 1. Schematic of a two-stage ABE fermentation integrated with a pervaporation unit. Arrows show the direction of liquid flow.

# Alternative process vs Conventional process

## ISPR of ABE using hydrophobic pervaporation: energy considerations



Pervaporation = promising for butanol and 2G ethanol recovery

# Bioethanol dehydration for gasoline mix using hydrophilic pervaporation

NF EN 15376 : 2008-03

Propriété	Unités	Limites	
		Minimum	Maximum
Teneur en éthanol+alcools supérieurs saturés	% (m/m)	98,7	
Teneur en mono-alcools supérieurs saturés (C3-C5)	% (m/m)		2,0
Teneur en méthanol	% (m/m)		1,0
<b>Water content</b>	<b>% (w/w)</b>		<b>0.3</b>
Teneur en chlorures minéraux	mg/l		20,0
Teneur en cuivre	mg/kg		0,100
Acidité totale (exprimée en teneur en acide acétique)	% (m/m)		0,007
Apparence		Clair et limpide	
Teneur en phosphore	mg/l		0,50
Teneur en produits non volatils	mg/100ml		10
Teneur en soufre	mg/kg		10,0



## Bioethanol dehydration for gasoline mix using hydrophilic pervaporation

**Bioethanol dehydration using pervaporation** : interesting alternative to traditional processes (azeotropic distillation and molecular sieves)

Extensive works have been focused on the development of **membranes with optimized flux and selectivity**

Little is known about membrane performances in the case of **(complex bioethanol, including 2G)**



**Study the effects of VOCs impurities on mass transfer mechanisms & process performances**

# Bioethanol dehydration for gasoline mix using hydrophilic pervaporation

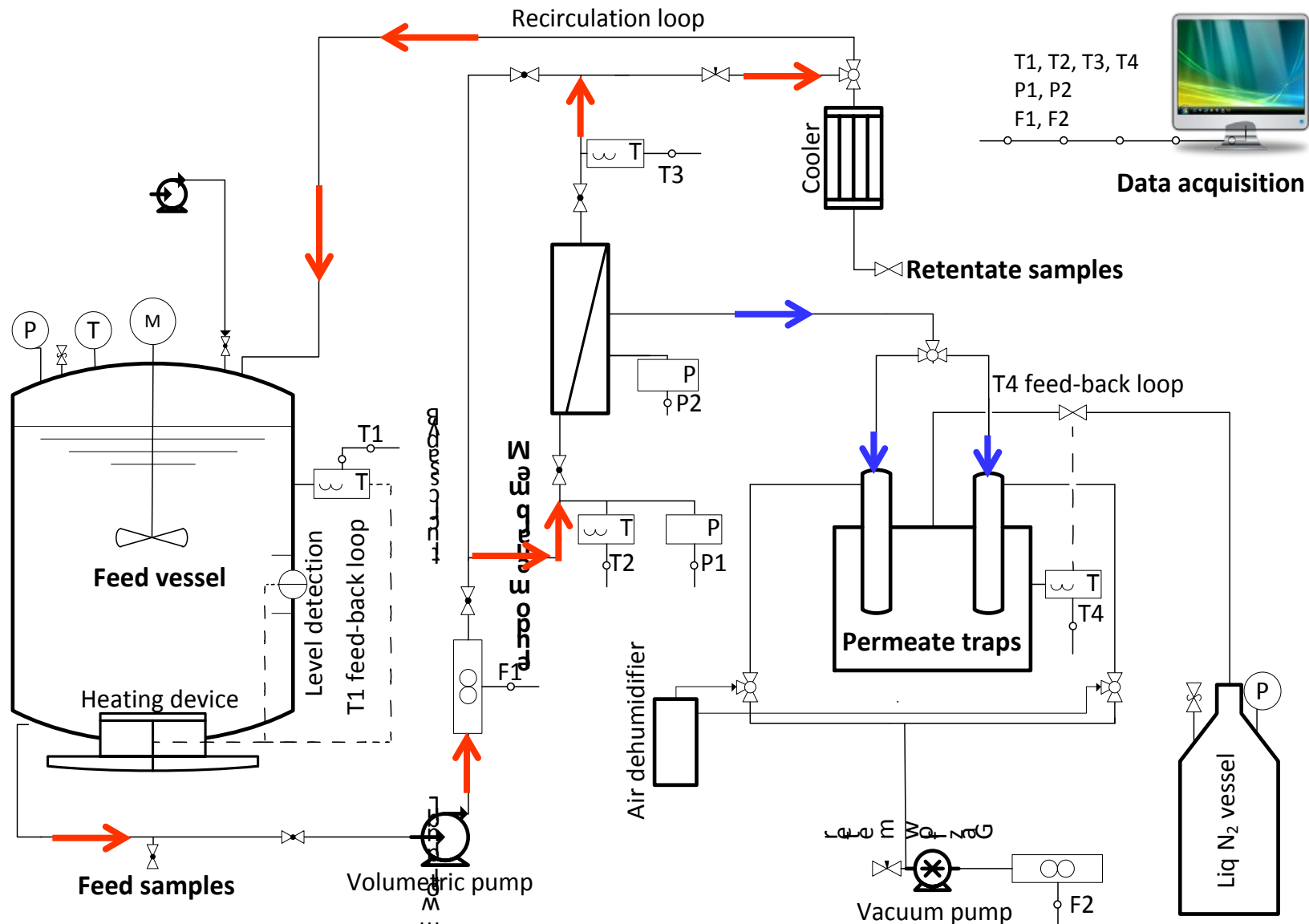

Experimental set-up for hydrophilic pervaporation (Moussa et al, 2015a)

# Bioethanol dehydration for gasoline mix using hydrophilic pervaporation

Experimental set-up for hydrophilic vapor permeation (Moussa et al, 2013)

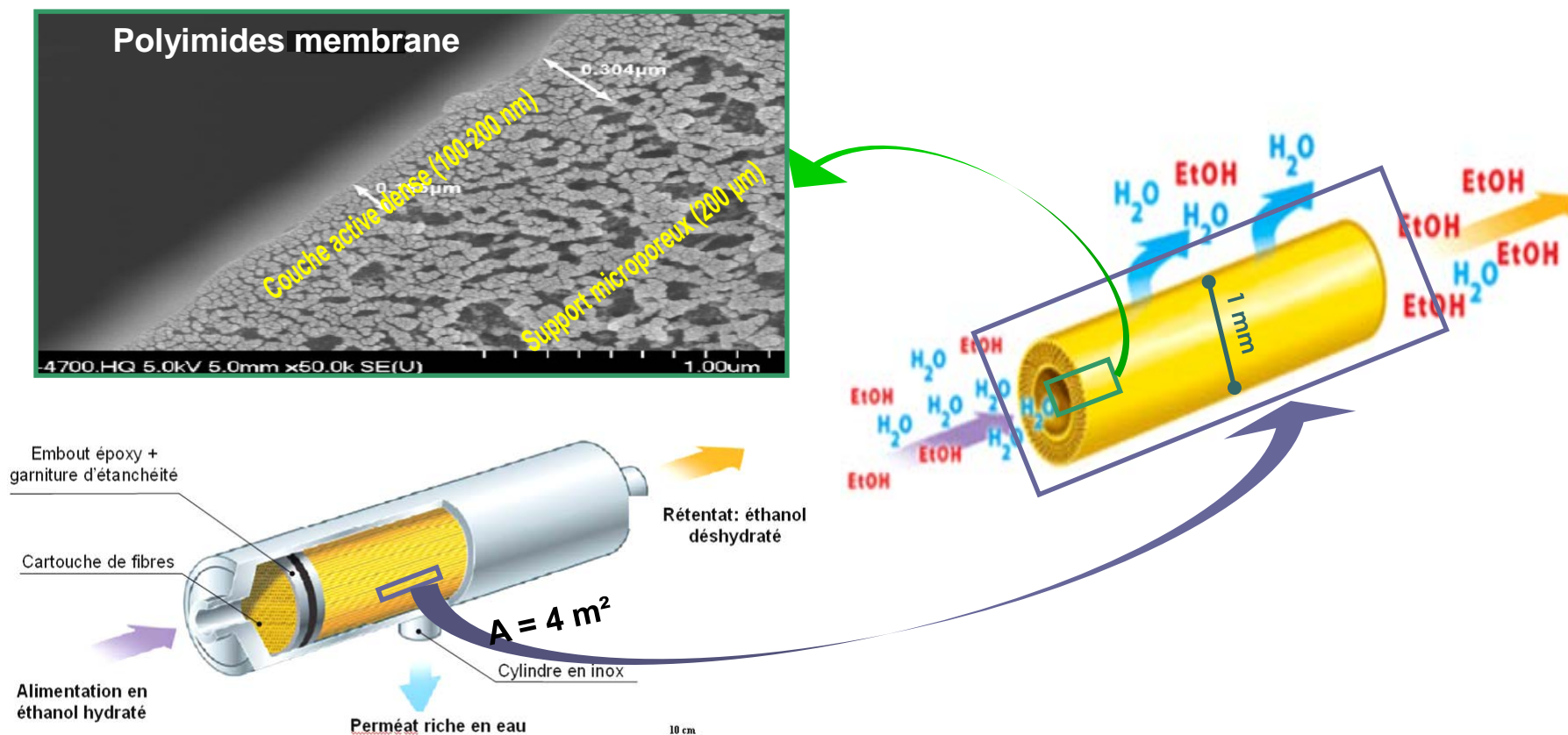

Sifteck® technology



# Bioethanol dehydration for gasoline mix using hydrophilic pervaporation

Experimental set-up for hydrophilic vapor permeation (Moussa et al, 2013)

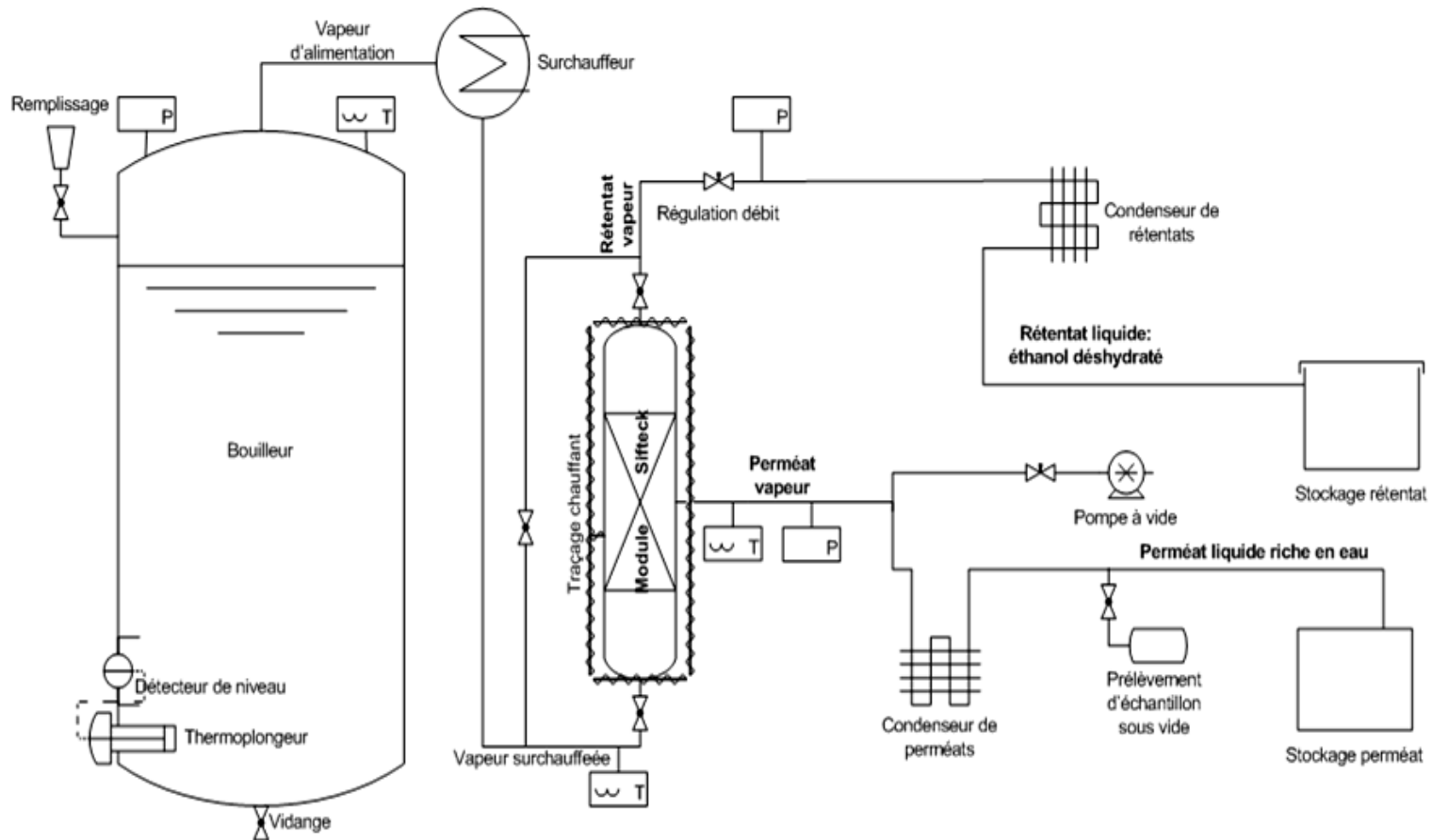

# Bioethanol dehydration for gasoline mix using hydrophilic pervaporation

Experimental set-up for hydrophilic vapor permeation (Moussa et al, 2013)



50 cm

Pilot plant, INRA, Paris

# Highlight 1 outcomes

## Efficiency proven at:

- The technical level (feasibility, scaling-up)
- Economic level (50% less energy consumption than conventional processes)
- Environmental level (50% less CO<sub>2</sub> emission)
- Continuous and flexible process

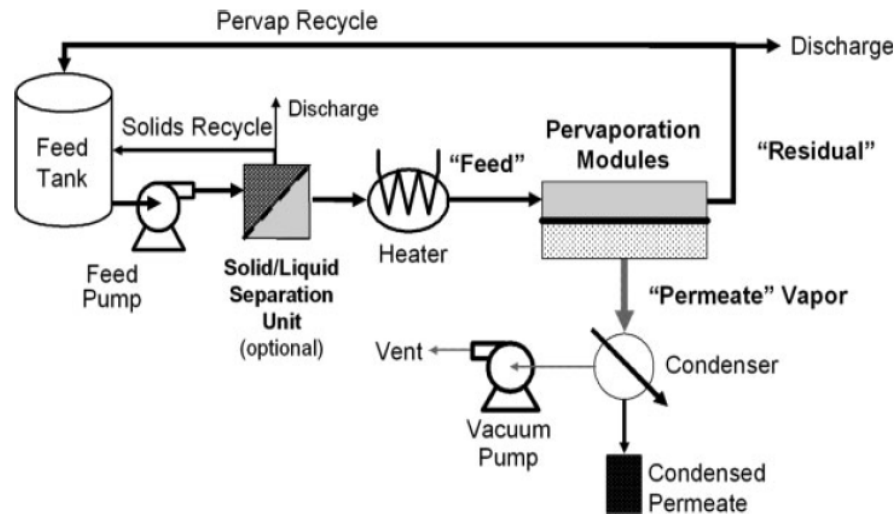

**Real opportunities for the intensification of bioalcohol fermentation processes (recovery and purification)**

**Need the active involvement of membrane suppliers**



# Integrated fermentation and separation for process intensification

Highlight 1: Pervaporation and vapor permeation for the *in situ* recovery and purification of bio-alcohols

**Highlight 2: Membrane contactors for the *In situ* reactive extraction of organic acids**

## 3-hydroxypropionic acid (3-HP): a key platform chemical

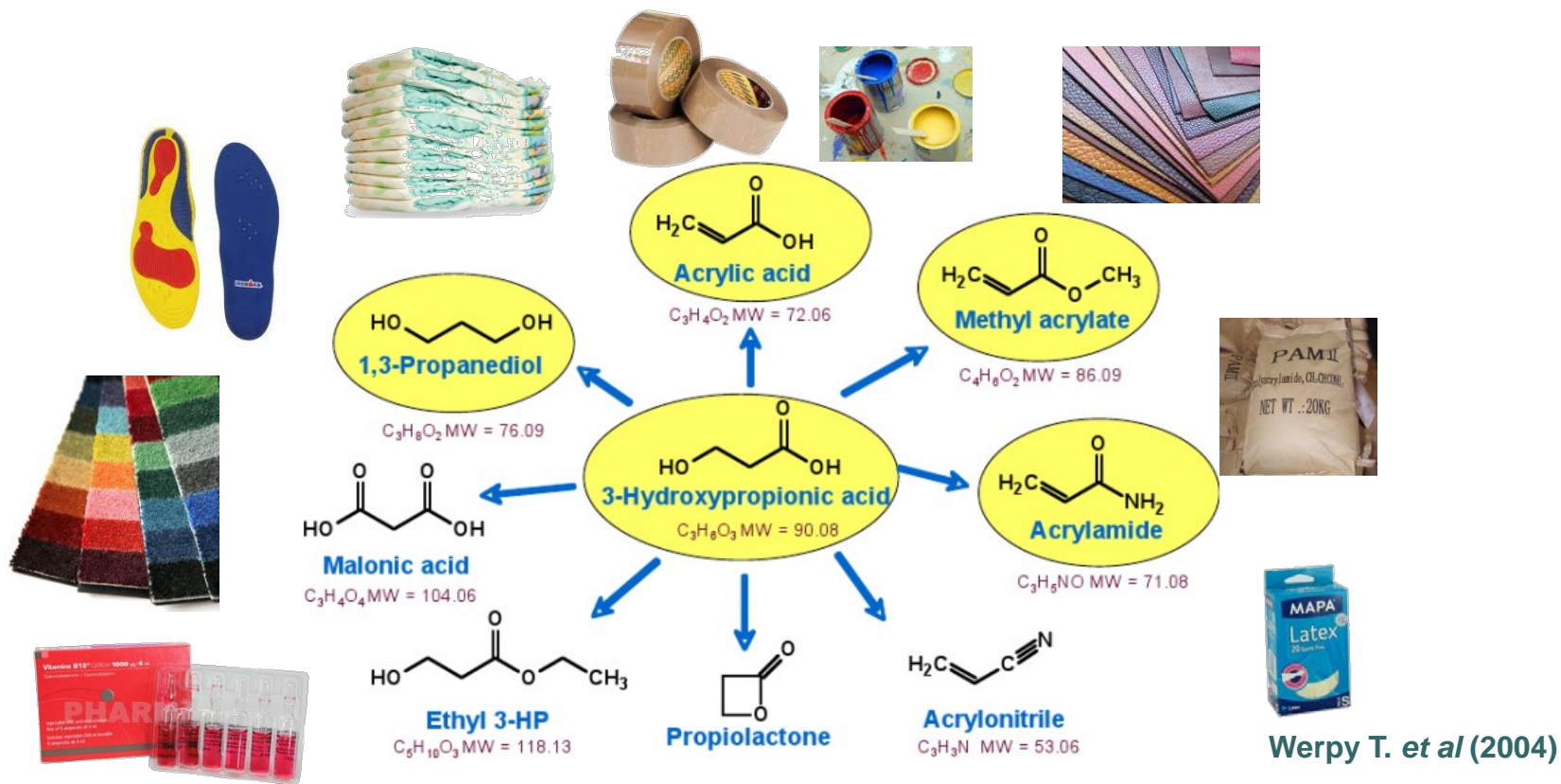

**Biotechnology:** a promising route for a sustainable production of 3-HP from renewable feedstocks (e.g. glycerol bioconversion)

# Strategy of the project

Separation Technology: reactive liquid-liquid extraction assisted by hollow-fiber membrane contactors (HFMC)

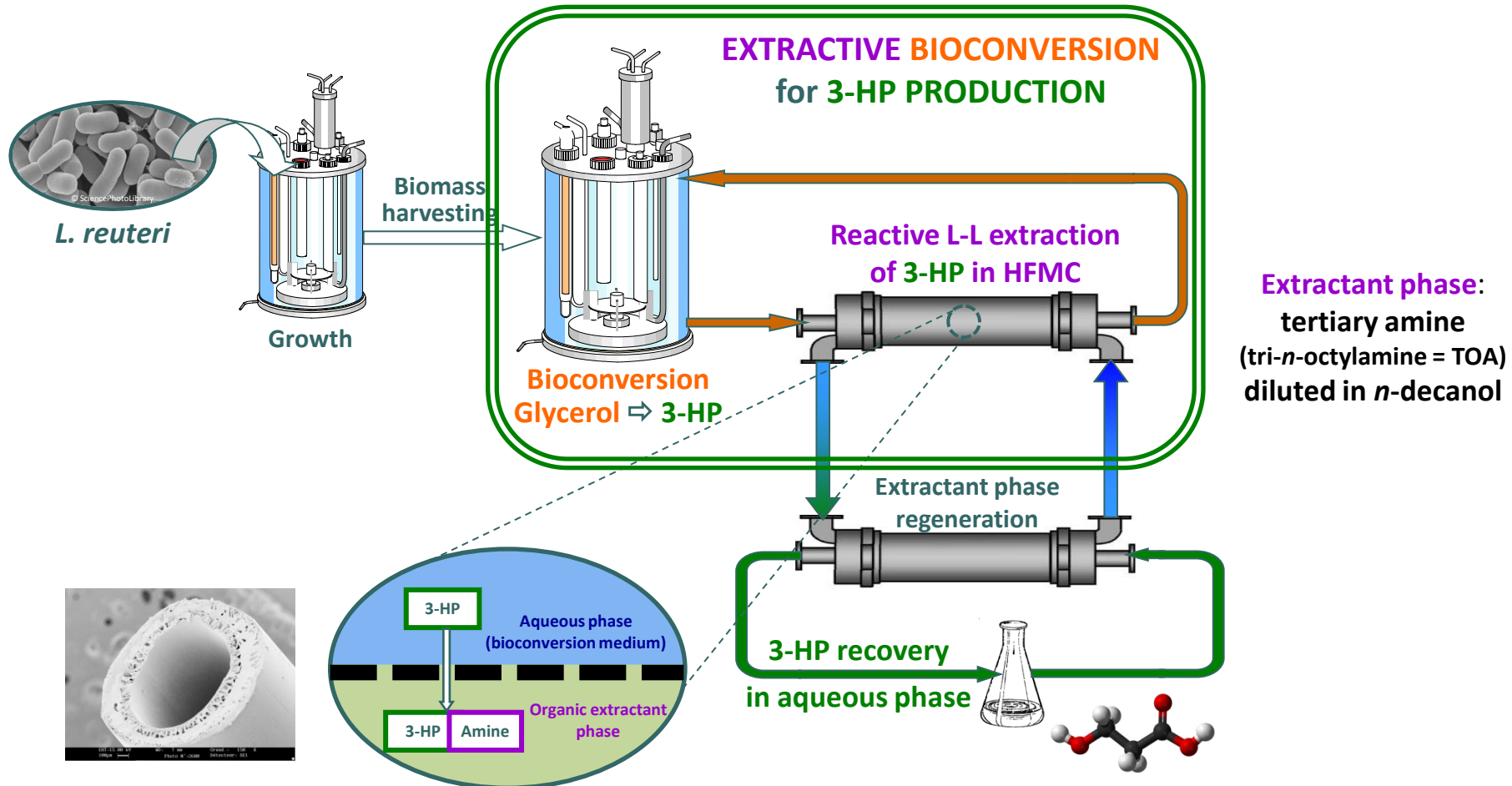

Ph. D. thesis of G. Burgé (2013-2015)  
Ph. D. thesis of F. Chemarin (2014-2017)  
Moussa et al (2015a)  
Burgé et al (2015 a, b and c)

# Highlight 2 outcomes

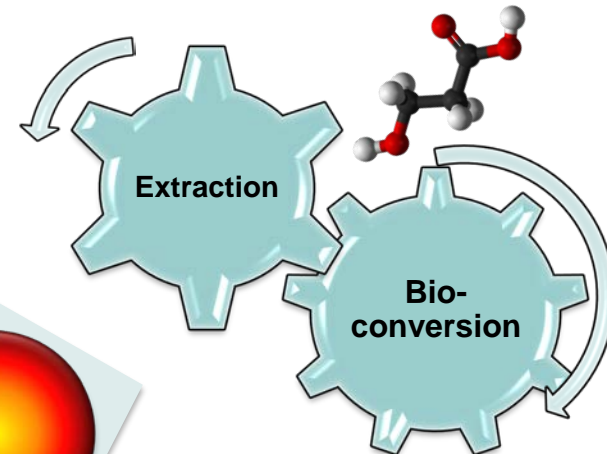

Successful implementation of HFMC

Successful back extraction of 3-HP

Coordination between upstream and downstream operations

Solvent and extractants biocompatibility

Compromises can easily be found between **bioconversion** and **extraction** operating conditions.

Significant decrease of the extraction performances in real bioconversion broth, even if the selectivity remained relatively high

Further work is needed to better understand the involved mechanisms

Effective conditions for the *ISPR* of 3-HP from bioconversion processes were pointed out:  
→ synergistic mixture of TOA and Aliquat 336

First experimental study focused on 3-HP reactive extraction

# General outcomes for the Joint Call Brazil-UE

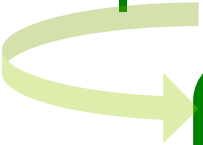

**Section “c”:** Development of new fermentation and separation technologies for advanced liquid biofuels and applied research to increase the energy efficiency of advanced biofuel processes.

- Interested partners: INRA-AgroParisTech (JRU GMPA) and Chair of IAB
- Other partners can be involved from the INRA and AgroParisTech networks
- Expertise in:
  - fermentation: study and optimization; physiological cell state as a key indicator (flow cytometry)
  - separation: membrane based processes
  - integrated extractive fermentation
  - bioethanol and biobutanol extractive fermentation
  - green chemistry through the valorization of lignocellulosic and oilseeds oil valorization





# Thank you for your attention



## **Marwen MOUSSA**

Maître de Conférences / Associate Professor, Ph.D.

[marwen.moussa@agroparistech.fr](mailto:marwen.moussa@agroparistech.fr)

[marwen.moussa@grignon.inra.fr](mailto:marwen.moussa@grignon.inra.fr)

Tel. : +33 (0)1 30 81 54 39

Fax : +33 (0)1 30 81 55 97

**UMR782 GMPA Génie et Microbiologie des Procédés Alimentaires**  
**Food Process Engineering and Microbiology**

**Key words: BioProcess Engineering, Separation, Membranes**

Bat CBAI AgroParisTech, 1, rue Lucien Brétignières

78850 Thiverval Grignon, France

<http://www6.versailles-grignon.inra.fr/gmpa>

<http://www.agroparistech.fr>

<http://www.chaire-abi-agroparistech.com>

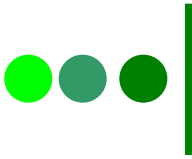

### Short Biography:

Dr. Eng. Marwen MOUSSA is Associate Professor (Maître de Conférences) in AgroParisTech (Institute of Technology for Life, Food and Environmental Sciences) in the field of bioprocess engineering and biorefining-green chemistry. He obtained a Ph.D. in process engineering from AgroSup Dijon (University of Burgundy-France) in 2009 and belongs to the INRA-AgroParisTech Joint Research Unit "Food Process Engineering and Microbiology" based in Grignon-France. Being a member of the "BioMiP" team (Bioproducts, food, Microorganisms and Processes), his multidisciplinary research activities deal with integrated membrane-based processes in white biotechnology: *in situ* product recovery and purification of bioalcohols, biobased organic acids and aroma compounds. The general aim of these activities is the sustainable transformation of agro-resources through the rationalised management of fermentation and separation processes.

### Significant projects:

2016-2017: «Development of a new extractive fermentation process for n-butanol production at high concentration, yield and productivity». 3BCAR Carnot Institute funding; partnership with the Laboratory of Biosystems and Process Engineering.

2013-2017: «Integrated process of glycerol bioconversion and membrane assisted reactive extraction for 3-hydroxypropionic acid production». Co-funding from the Chair of Industrial Agro-Biotechnology and INRA.

2009-2013: «Bioethanol dehydration using pervaporation and vapor permeation processes». Co-funding from ADEME, INRA, industrial distilleries and equipment suppliers.