



**HAL**  
open science

## Grid-Tied PV System with Energy Optimization

Maryam Shahjehan, Waleed Shahjehan, Muhammad Arbab

► **To cite this version:**

Maryam Shahjehan, Waleed Shahjehan, Muhammad Arbab. Grid-Tied PV System with Energy Optimization. International Journal of Engineering Works Kambohwell Publisher Enterprises, 2017, 4, pp.184-189. hal-01625191

**HAL Id: hal-01625191**

**<https://hal.science/hal-01625191>**

Submitted on 27 Oct 2017

**HAL** is a multi-disciplinary open access archive for the deposit and dissemination of scientific research documents, whether they are published or not. The documents may come from teaching and research institutions in France or abroad, or from public or private research centers.

L'archive ouverte pluridisciplinaire **HAL**, est destinée au dépôt et à la diffusion de documents scientifiques de niveau recherche, publiés ou non, émanant des établissements d'enseignement et de recherche français ou étrangers, des laboratoires publics ou privés.



## Grid-Tied PV System with Energy Optimization

Maryam Shahjehan, Waleed Shahjehan, Muhammad Naeem Arbab

**Abstract**—Electricity that is generated from coal, natural gas and fossil fuel has an impact on human health and also causes global warming. The integration of renewable energy sources with the grid is a good solution to these problems. This approach is known as smart grid. Sources of renewable energy such as wind or PV are not able to provide a continuous supply of energy to the load due to periodic or seasonal variations. Connecting these renewable sources to the grid can help in overcoming these problems as the grid will ensure continuous supply of power to the load. The smart grid can help in reducing the impacts on human health and effects on environment and can also help in increasing efficiency, reliability and security of the grid. Simulations were carried out on Matlab software and their results shows that the use of solar system with the grid helps in reduction of the electricity charges.

**Keywords**— Smart grid, Solar system, Grid connected system, Renewable energy, Continuous supply of energy.

### I. INTRODUCTION

For attaining some goals such as balance between customer load demand and generation, reducing the cost of electricity, reducing the burden on the grid and increasing the amount of power from renewable sources, smart grids have played an important role [1]. Intelligent devices are installed and used with components at different distribution and transmission levels in order to enhance the reliability and security of the main grid. Smart grids are a part of efficient, safe and environment-friendly energy system. The accuracy of non-linear calculation of consumption of power has been improved through system of smart metering. The purpose of recent initiatives of smart grid is to enhance the efficiency of the grid by decreasing its environmental cost [2]. Renewable sources of energy can be used in islanded mode or can be integrated to the grid. Grid-tied renewable sources of energy can be used for which the grid behave as a dispatchable source and supply of power to the load is made continuous.

### II. SOLAR PHOTOVOLTAIC SYSTEM

Efficiency of solar cells is a very important factor which is currently 18.3% in commercial market but the efficiency of module is a little bit lower than the cell efficiency due to spaces between cells in a module. The efficiency of the system takes into consideration all the system component's performance.

Several factors like electrical performance of solar cell, factors of degradation, the capability of producing power of an array, environmental factors and operating temperature of a cell determine the performance of an array.

#### A. Output Power of PV Array

It is the amount of power that a PV array will produce and is expressed in watts which is either specified as peak watts or average power for a day.

#### B. Output Energy of PV Array

It is the amount of energy that a PV array will produce and is expressed in Wh.

#### C. Characteristics of PV array

##### a. Effect of Irradiance

The incident irradiance affects the output power of PV. Fig. 1 shows the effect of irradiance on current and voltage of the PV module. The current in case of short circuit of the PV increases linearly with increase in irradiation, whereas there is an exponential increase in open circuit voltage with the increasing irradiation [3].

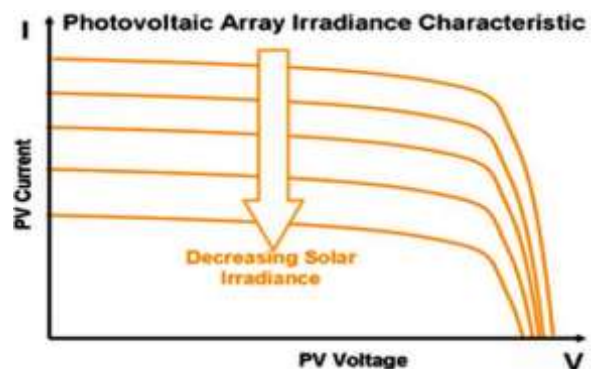

Figure 1. Effects of irradiance on current and voltage of PV module

##### b. Effect of Temperature

The ambient temperature highly affects the temperature of the module. Fig. 2 shows the effect of ambient temperature on current and voltage of the PV module. When the temperature of the PV module rises above 25°C, the current for short circuit increases. However, the effect on open circuit voltage is enormous. It means that the increase in current is relatively lower than the decrease in voltage. So the PV output power is reduced [3].

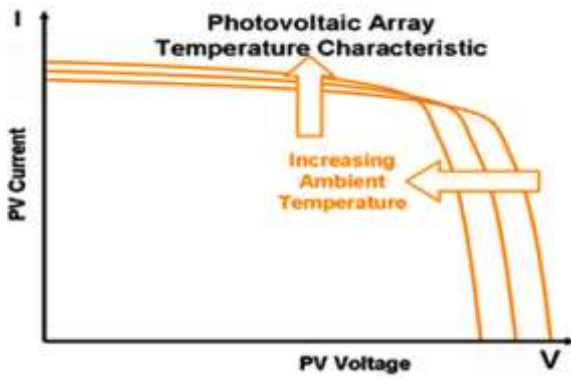

Figure 2. Effect of ambient temperature on current and voltage of module

c. *Maximum Power Point*

It is the point where the electrical power obtained from the PV is maximum. In Fig. 3, the maximum power point (MPP) is represented by the I-V curve's knee. It is obtained by multiplying the current at the MPP and voltage at the MPP. It is the maximum power possible at standard conditions [4]. The usable output power depends on efficiency of the module.

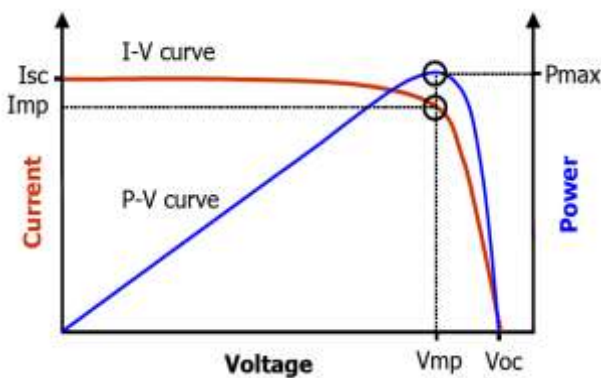

Figure 3. Maximum power point

d. *Fill Factor (FF)*

It is an essential parameter for PV module which represents the largest rectangular area that fits in I-V (current-voltage) curve. It is shown in Fig. 4. The output power magnitude depend on fill factor (FF). If the value of fill factor is high, the output power will also be higher. It is actually the ratio of two rectangular areas. Equation (1) shows the formula for fill factor. A unity fill factor (ideal case) shows that both the rectangles are similar [4].

$$FF = \frac{I_{max.pt} \times V_{max.pt}}{V_{oc} \times I_{sc}} \quad (1)$$

Where  $I_{max.pt}$  is the current at the maximum power point and  $V_{max.pt}$  is the voltage at the maximum power point.  $V_{oc}$  is the open circuit voltage and  $I_{sc}$  is the short circuit current.

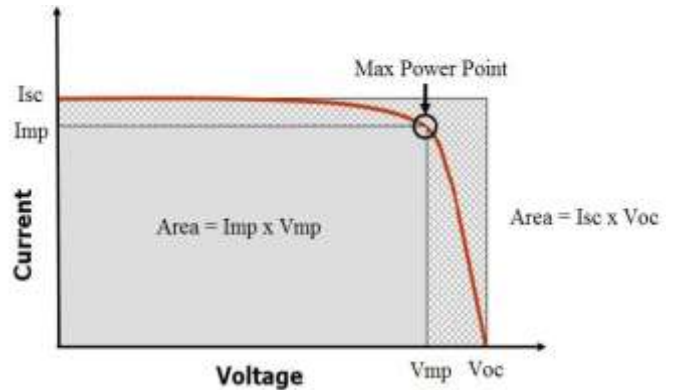

Figure 4. Fill factor

e. *Efficiency of Module*

The efficiency of the PV module or cell is its ability of converting sunlight into electricity. Mathematically, it is the ratio of module output power to area and is given by (2).

$$\eta_{max} = \frac{V_{max.pt} \times I_{max.pt}}{G \times A} \quad (2)$$

Where  $I_{max.pt}$  is the current at the maximum power point and  $V_{max.pt}$  is the voltage at the maximum power point.  $A$  is area of module and  $G$  is global irradiance which is considered 1000 W/m<sup>2</sup>.

D. *Parts of a PV Module*

a. *Front Surface*

It is basically a cover of glass. It should have low capability of reflection for concerned wavelength of sunlight. It should have high transmission. Iron glass is normally used due to some reasons such as low cost, stability, strength, high transparency as it is impermeable to gases and water [5].

b. *Encapsulant*

It provides strong bonds between the cells in module. It needs to be stable for different range of operating temperatures and must have low thermal resistance and highly transparent [5]. A thin layer of EVA (ethylene vinyl acetate) is used at back and front surface of assembled cells.

c. *Back Surface*

It is a back sheet for PV module which can be made from glass or thin polymer. Its thermal resistance should be low [5]. Fig. 5 shows the layers in the PV module.

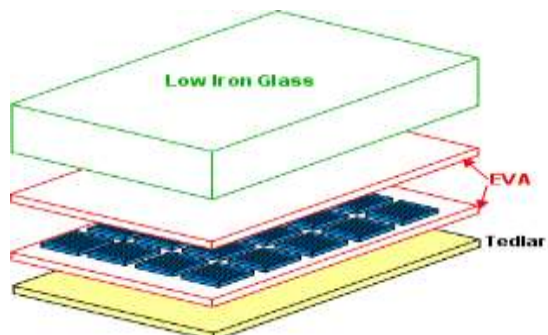

Figure 5. Layers in PV module

### E. PV Technologies

Mainly, there are two types of PV technologies; thin film and silicon crystalline technologies. Nowadays, the multi-junction is in processing and under research, to improve the efficiency of PV modules and to enhance response sensitivity of spectrum of sunlight to entirely cover the wavelength of incident irradiation.

#### a. Crystalline Solar cell technology

Crystalline solar cells are the most efficient solar cells in the market. The PV cells based on silicon are generally long lasting and more efficient than any other cells [6]. However, higher temperature for operation results in reduction of efficiency.

##### 1. Monocrystalline solar cell Technology

They are the most efficient solar cells made from wafers of silicon after a complex process of fabrication [6]. Their efficiency is 15-18%. They are available in many shapes such as round, square or semi-round. Their thickness lie between 0.2-0.3mm. Square or semi-round cells are a bit expensive than round ones as more material is wasted during their production but the round ones are still used rarely because they don't properly utilize the space of module. They are available in different colors such as black, dark blue (with anti-reflection coating) and grey (without anti-reflection coating). Fig. 6 shows a layered structure of monocrystalline solar cell.

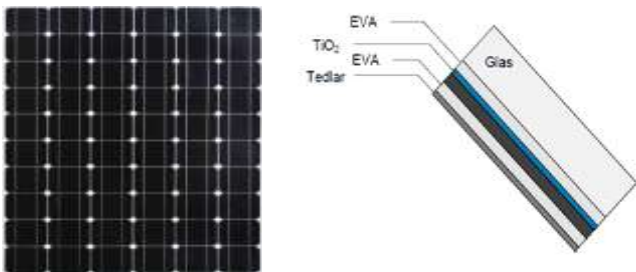

Figure 6. Monocrystalline PV module

##### 2. Polycrystalline solar cell technology

Their cost per unit area is less than monocrystalline solar cells but the structure of module for polycrystalline module and monocrystalline module are similar. Use of large square cells increase the efficiency of the module. Their efficiency is 13-16%. They are available in square shapes with 0.24-0.3mm thickness. They are available in different colors such as blue (with anti-reflection coating), grey, gold, brown, green (without anti-reflection coating) and silver. Fig .7 shows a polycrystalline module and cell.

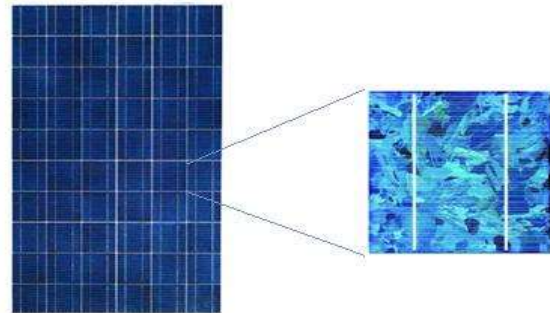

Figure 7. Polycrystalline module and cell

#### b. Thin film solar cell Technology

Thin film represents second generation of PV. Because of their less consumption of energy and less material required for production, they are cheaper as compared to crystalline solar cells. The semiconductor materials used include cadmium telluride, copper indium selenium and amorphous silicon. They have high ability to absorb light, so a low thickness such as 0.001mm would be sufficient to convert the incident irradiation [7]. They generally do not have a standard size of wafer like crystalline solar cells. The substrate of thin film technology can be of any size coated with a material of semiconductor.

Despite the fact that their efficiency is low per unit area, they have many advantages in comparison to the crystalline technology. They are not very sensitive to high temperature for operation. They are not very sensitive to shading due to narrow and long strip design whereas shaded cell in crystalline module will have effect on the performance of whole module. Their energy yield is higher than crystalline under certain condition. They can utilize the low and diffuse intensity of light in a better way.

Fig. 8 shows a thin film solar module.



Figure 8. Thin film solar module

##### 1. Amorphous Silicon solar cell technology

In this technology, a very thin layer of silicon is deposited on glass, metal or plastic. It is not preferred to install this technology on roof as its efficiency is low per unit area. Another drawback of this technology is degradation with induced light which decreases the efficiency of module during the starting 6-12 months before the nominal power output is levelled at a stable point or value. This effect is called Staebler-Wronski effect [7]. They have relatively lower efficiency 5-7%. The thickness of substrate is 1-3mm while the coating thickness is 0.001mm with about 0.0003mm amorphous silicon. They can be in blue, reddish-brown and blue-violet colors.



Fig. 9 shows the amorphous silicon module and layered structure of its cell.

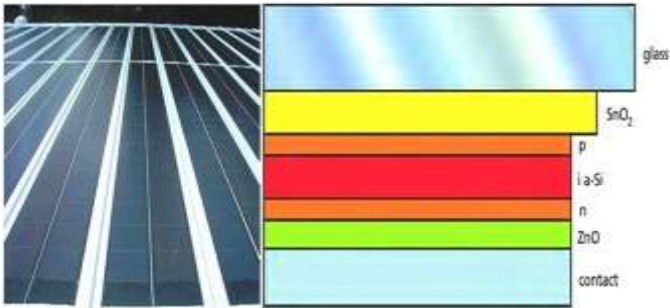

Figure 9. Amorphous modules and amorphous cell layered structure

### 2. Copper indium Selenide technology

It has the highest efficiency among the thin film solar cell technology. The di-selenide is also sometimes alloyed with Sulphur or gallium. Unlike amorphous silicon, it is not degraded with induced light. The cost for its processing method is low and it uses very less active material [7]. Its spectrum response is wide for sunlight. Their efficiency is 9-11%. The thickness of substrate is 2-4mm with coating thickness of 3-4µm. They can be in black or dark grey colors. Fig. 10 shows copper indium selenide based module and the layered structure of its cell

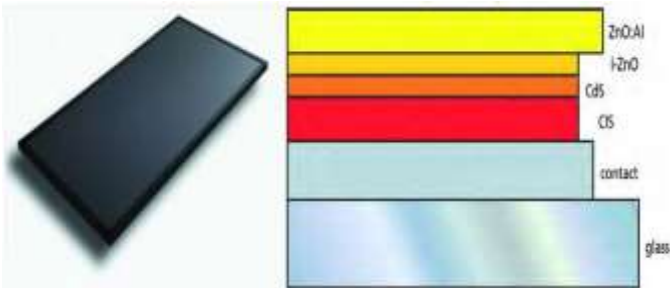

Figure 10. CIS module and CIS cell layered structure

### 3. Cadmium Telluride solar cell technology

This technology has the lowest cost for production as compared to any other thin film technology. They are not degraded with induced sunlight [7]. They have 7-8.5% efficiency. The substrate is 3mm thick with a coating thickness of 0.005mm. They are available in dark green or black colors.

Fig. 11 shows the Cadmium telluride module and layered structure of its cell

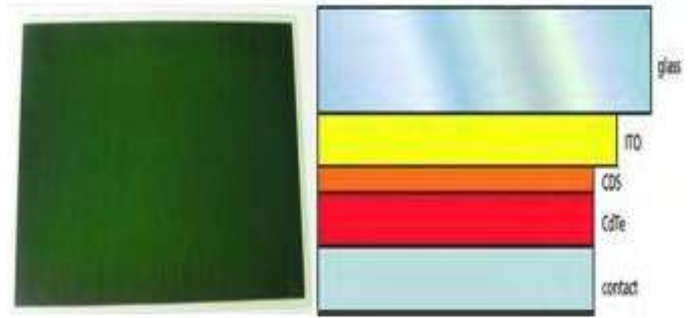

Figure 11. Cadmium telluride module and layered structure of its cell

### 4. Micromorphous Technology

This technology combines amorphous silicon and microcrystalline in a tandem structure which improves the module performance. They are capable of responding to wide band of wavelength of solar spectrum, so their efficiencies can reach to 9.1%. Their degradation with induced light is less than amorphous cells [7].

Fig. 12 shows a layered structure of the micromorphous technology along with its spectrum response.

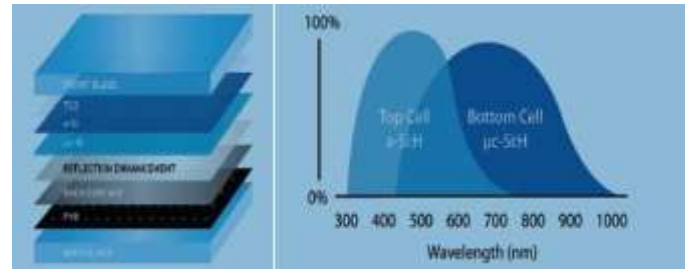

Figure 12. Layered structure of micromorphous technology with its spectrum response

## III. RESULTS AND DISCUSSION

If the PV system was not used, grid will provide all power to the load as shown in Fig. 13. The grid connected PV system used in this paper is shown in Fig. 14. It is composed of PV array that is connected to the grid.

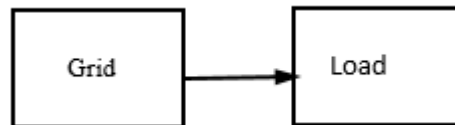

Figure 13. Block diagram without PV system

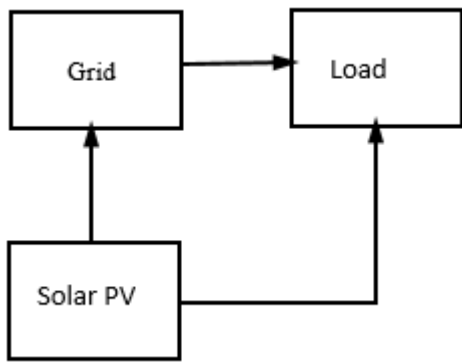

Figure 14. Block diagram with PV system

Hourly load data is taken for a home for a period of 24 hours of a day. The plot for the load demand of the home is shown in Fig. 15.

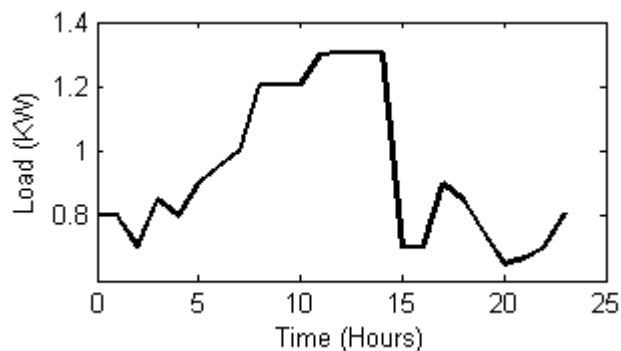

Figure 15. Load demand of home

Fig. 16 shows the PV output power for a 2KW array used in this simulation. The technology used for its manufacturing is the polycrystalline silicon.

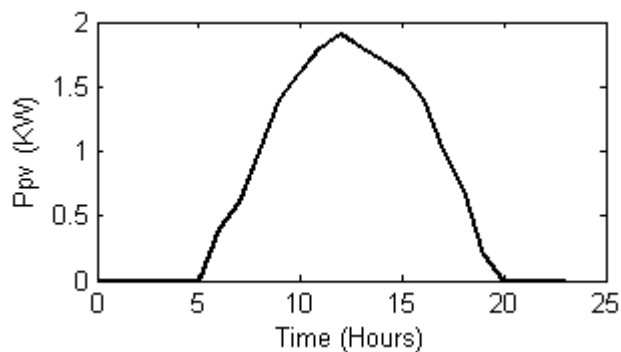

Figure 16. 2KW PV array output power

Without the use of solar system, all the power to the load will be provided by the grid but with the use of the hybrid system, the power taken from the grid decreases as shown in Fig. 17. No power is taken from the grid from 9am-6pm because the PV output power during this time is greater than the load demand.

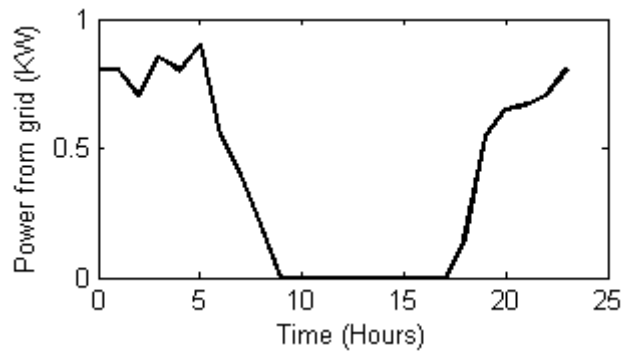

Figure 17. Power taken from the grid

If the generated PV output power is greater than the power required by the load, the excess PV power is sold to the grid as shown in Fig. 18.

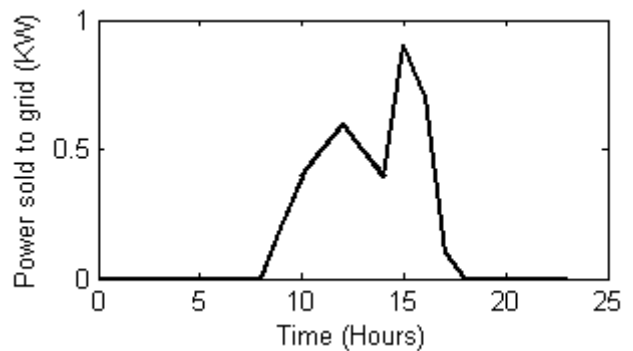

Figure 18. Power sold to the grid

The cost of electricity decreases after the use of PV system. The cost of the home with and without the solar system is shown in Fig. 19.

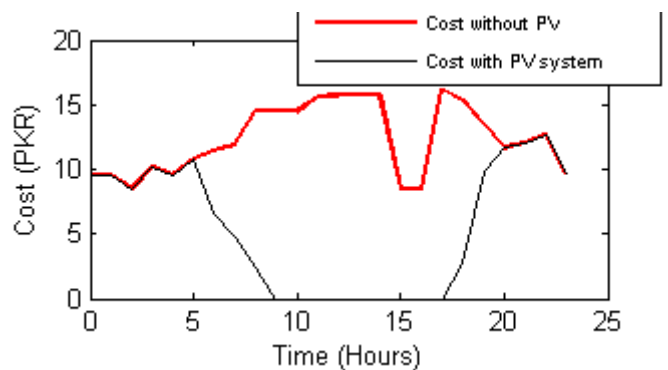

Figure 19. Cost of energy with and without PV system

The daily cost of electricity without the PV system is 295.53PKR (Pakistani Rupees) and after the installation of this solar PV system it becomes 130.83PKR. The amount of electricity that is being sold to the grid generates a revenue of 51.9PKR on daily basis. So we will be charged 78.93PKR for electricity usage on daily basis which means that with the introduction of PV system in the home, we can save 216.6PKR daily.

#### IV. CONCLUSION

This paper has shown the advantages of PV integration with the main power grid. The system becomes reliable and stable and can handle the changes in solar system. The grid connectivity balances the intermittent nature of solar PV and helps to provide power to the load continuously. Moreover, with the use of renewable energy, the power usage from the main grid is minimized.

#### REFERENCES

- [1] Sun, W., and T. Egbelakin. "Adoption of Solar Grid-Tied PV-System Adopted in a Residential Building." 80-88.
- [2] Lee, Hyung-Joo, et al. "Renewable integration algorithm to compensate PV power using battery energy storage system." *Energy (IYCE), 2017 6th International Youth Conference on*. IEEE, 2017.
- [3] sa'd Basha, Laith. "Analysis and evaluation tools development of photovoltaic modules and system performance under Jordanian and German climatic conditions." *CU Theses* (2012).
- [4] Guide To Interpreting I-V Curve Measurement of PV Array," The Solmetric ,<http://www.solmetric.com>, March, 2011.
- [5] S. B. Christiana Honsberg, "pvcdrom," Jan 2012. [Online]. Available: <http://pveducation.org/pvcdrom>
- [6] "Solar facts and advice," Alchemie Limited Inc, Feb 2012. [Online]. Available: <http://www.solar-facts-and-advice.com>
- [7] Planning and installing photovoltaic systems, "A guide for installers, architects and engineers",Deutsche Gesellschaft für sonnenenergie (DGS LV Berlin BRB). , 2008, [www.earthscan.co.uk](http://www.earthscan.co.uk).