



HAL
open science

Modeling the nonlinear mechanical response of reinforced concrete structures by simplified approaches

Alaa Eddin Iskef, Fabrice Gatuingt, Frédéric Ragueneau, Cédric Giry

► To cite this version:

Alaa Eddin Iskef, Fabrice Gatuingt, Frédéric Ragueneau, Cédric Giry. Modeling the nonlinear mechanical response of reinforced concrete structures by simplified approaches. Third International Conference on Geotechnics, Buildings and Structures (CIGOS 2015), May 2015, Paris, France. hal-01623728

HAL Id: hal-01623728

<https://hal.science/hal-01623728>

Submitted on 25 Oct 2017

HAL is a multi-disciplinary open access archive for the deposit and dissemination of scientific research documents, whether they are published or not. The documents may come from teaching and research institutions in France or abroad, or from public or private research centers.

L'archive ouverte pluridisciplinaire **HAL**, est destinée au dépôt et à la diffusion de documents scientifiques de niveau recherche, publiés ou non, émanant des établissements d'enseignement et de recherche français ou étrangers, des laboratoires publics ou privés.



Modeling the nonlinear mechanical response of reinforced concrete structures by simplified approaches

ISKEF Alaa Eddin

ENS-Cachan/CNRS/Univ. Paris-Saclay

61, Avenue du Président Wilson - F-94235 Cachan – France

(iskef@lmt.ens-cachan.fr)

GATUINGT Fabrice

ENS-Cachan/CNRS/Univ. Paris-Saclay

61, Avenue du Président Wilson - F-94235 Cachan – France

(gatuingt@lmt.ens-cachan.fr)

RAGUENEAU Frédéric

ENS-Cachan/CNRS/Univ. Paris-Saclay

61, Avenue du Président Wilson - F-94235 Cachan – France

(raguenea@lmt.ens-cachan.fr)

GIRY Cédric

ENS-Cachan/CNRS/Univ. Paris-Saclay

61, Avenue du Président Wilson - F-94235 Cachan – France

(giry@lmt.ens-cachan.fr)

Abstract:

This work aims to develop and identify a new model for reinforced concrete joint element subject to cyclic loadings. Based on experiments and 3D numerical modeling, a simplified model of RC beam-column joint is introduced (within the framework of macro-element). In a first experimental study, this joint will be tested under reverse cyclic loading applied at the beam tip to identify its behavior under this kind of loading in terms of strength, stiffness and ductility. In parallel of experiments, a finite elements model of the joint based on 3D finite elements is presented to highlight and define the nonlinear mechanisms involved in the ruin of the assembly. This step will confirm the experimentally observed phenomena: damage, friction, plasticity. Secondly, a simplified macro-element model for beam-column joint, associated to a nonlinear behavior, is introduced to reflect the response of the joint under cyclic loading loads. Model parameters will be identified from experimental results and analysis on a local scale via 3D finite element calculation. Finally, numerical analyses will be performed to validate the proposed approach in comparison with the experimental tests.

Keywords (5): RC Structures, Finite element, Macro-element, Nonlinear analyses, experiments

Main subthemes: *Modeling of structures (AMS)*

1 Introduction

1.1 Context and objective of the research

Constructive deficiencies of buildings are generally not known before earthquakes tragically highlight them. Several recent seismic events have shown weaknesses of buildings having a reinforced concrete (RC) structure built with wrong “Capacity Design” principles. Moment resisting frames (MRF) built until the end of the 1970s are generally very sensitive to lateral actions and their poor performance results often in brittle collapse during an earthquake (see Figure 1-1). In most cases, the reasons of such undesirable behavior for these RC structures can be identified as being due to a deficient design of beam-column connections and in particular of exterior beam-column joints (see Figure 1-1).

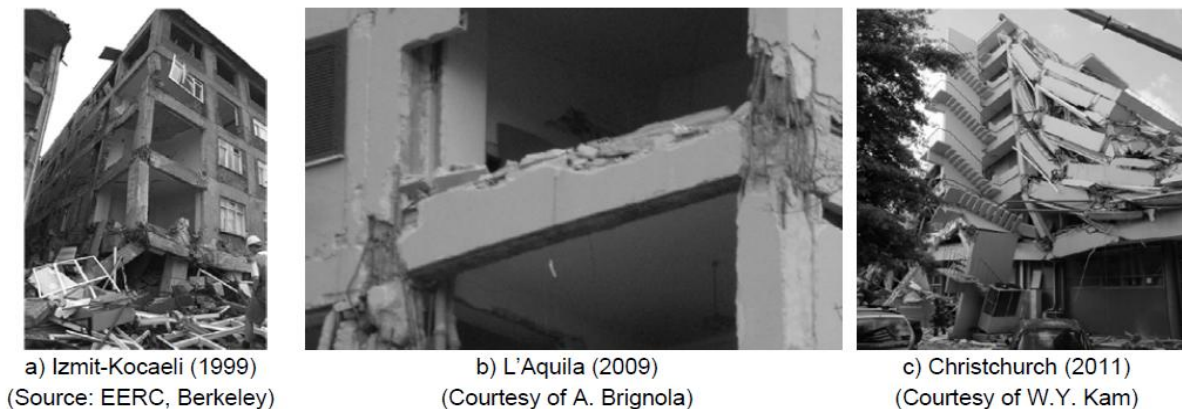

Figure 1-1: Joint failures in RC buildings during past earthquakes

In the past few decades some researches has highlighted that the causes of low joint shear strength and consequent brittle behavior of joints can be found in the lack of shear reinforcement in the core and an inadequate anchorage of the beam reinforcement bars in the joint panel. Although a significant research effort has been spent on this topic, there is still major uncertainty in the seismic assessment of so-called substandard exterior beam-column joints. A large variety of typologies of beam-column connections can be found in RC structures (see Figure 1-2) but to simplify our approach, only a 2D case of an exterior joint is considered in this paper. Therefore, in this study the development of numerical tools based on macro-element to describe the behavior of such substandard beam-column connections is targeted.

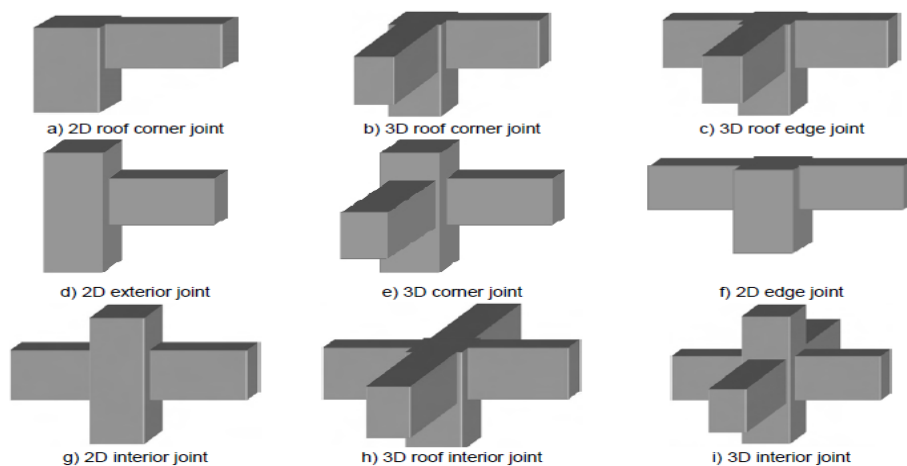

Figure 1-2: Classification of typical beam-column joints

1.2 Mechanics of RC exterior beam-column joints

From a structural point of view, a beam-column joint can be considered elastic if the plastic deformations of the connection occur only in the beam and/or the column and if the joint panel remains uncracked during the entire loading history. Conversely, a beam-column joint is defined as plastic if, during the loading reversals, there is some inelastic behaviors in the joint panel (cracking, rebar debonding, ...).

A beam-column joint can also be described as the region formed by the intersection of beams and columns. Therefore, each of the three elements can fail under different modes: beam flexural failure, beam shear failure, column flexural failure, column shear failure, joint shear failure, bond failure of the reinforcement or combination of the various modes. It is well known that some of these failure modes should be avoided if the beam-column connection undergoes large plastic deformations (shear failures of beam, column or joint and bond failure of reinforcement). Due to the limited deformation capacity of such brittle plastic mechanism, a collapse of the whole frame may result (see Figure 1-1).

2 Numerical investigation of the mechanical behavior of joint-element

A large number of numerical approaches for the simulation of beam-column joints have been developed. These approaches include, lumped plasticity models, multi-spring models, finite element simulations and fracture mechanics based approaches. These methods may be divided into two groups with reference to the ultimate aim of the numerical analysis. The first group of models aims to simulate the joint strength and rotation within a MRF (Moment Resisting Frame). They are due to the observation that the plastic behavior of a frame cannot be properly simulated taking into account only the strength-deformation contribution of beam and column while neglecting the joint shear strength and distortion. In this type of models, the behavior of the joint is assumed to be known. Examples of this type of models are (Figure 2-1):

- Rotational hinge models : (Alath & Kunnath, 1995)
- Multi-spring models : (Biddah & Ghobarah, 1999) , (Lowes & Altoonash, 2003)
- Complex joint response model : (Elmorsi, et al., 2000)
- Fiber models : (Braga, et al., 2001)

The models of the second group are more sophisticated. They usually involve a Finite Element (FE) model and are often developed with the investigation of the joints load-deformation behavior and the effect of different parameters. These types of models are very demanding in terms of computational requirements and are usually not suitable for the analysis of an entire 3D structure. They are usually used to save much more expensive experimental tests, as in (Eligehausen, et al., 2009), (Genesio, et al., 2010).

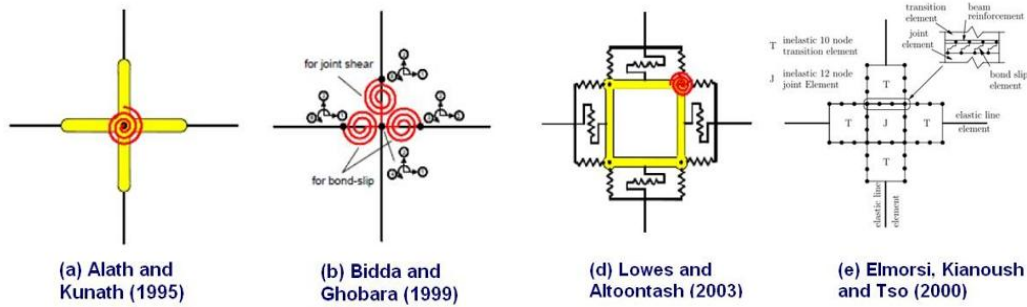

Figure 2-1: Macro-element models

2.1 3D analysis

This analysis aims to point out different sources of nonlinearity under cyclic and seismic loading and to complete the information given by experimental tests about the failure mode, the ultimate force or the displacement capacity up to failure. This kind of 3D modeling studies allow us to justify our future choice of internal variables of a macro-model and to quantify their evolution that will be introduced in the constitutive behavior of the macro-model. Until the date of preparation of this paper, we have not yet experimental results, so, the aim of these analyses is to test different concrete behavior laws on the 3D modeling of exterior beam-column joint by using software Cast3M in order to verify their limits, application domain and their computing capabilities.

2.1.1 Constitutive law for concrete and bar reinforcement

A perfectly plastic model is used for the steel reinforcement bars and two models based on isotropic damage mechanisms are introduced for the concrete behavior as described below:

- MAZARS (Mazars, 1984) : a single scalar damage variable is introduced to reproduce the stiffness degradation experimentally observed. The dissymmetry between tension and compression strength is also taken into account. This model is very simple and robust but it is not really suitable to model the behavior of concrete under cyclic loading (Figure 2-2).
- DAMAGE_TC (Costa, et al., 2004) : In this model, damage and plasticity are combined. The mechanism of degradation of the tensile material has been decoupled from the compression by introducing two variables of damage, one for the tension and other one for compression. The model can be energetically calibrated through the cracking energy and a characteristic length. The unilateral effect (cracks closure in compression) is taken into account to model the

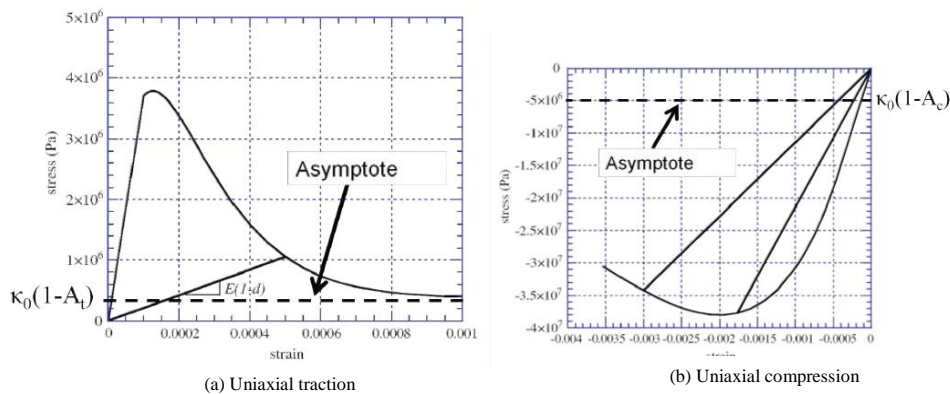

Figure 2-2 : Response of MAZARS model behavior under cyclic loading (Figure 2-3).

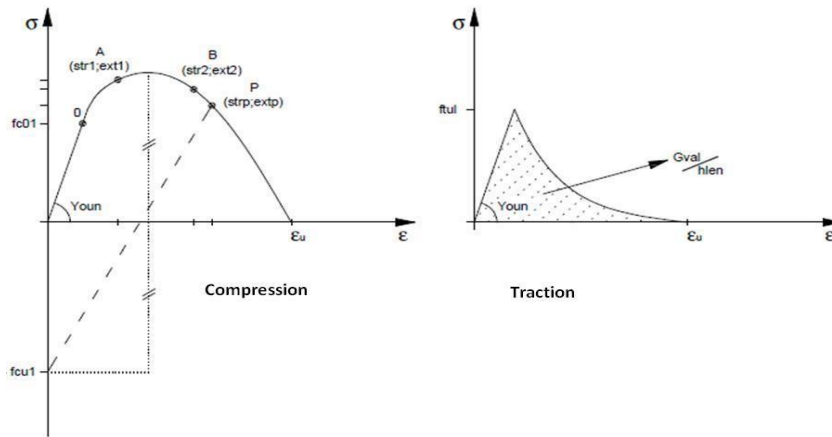

Figure 2-3 : DAMAGE_TC model in traction and compression

The parameters introduced in the computation are given in the following tables based on characteristic test of all materials used for the experimental analysis.

Table 1 : Material features for the 3D nonlinear computations

| | Young's modulus (Gpa) | Poisson's ratio | σ Compression (Mpa) | σ Traction (Mpa) |
|----------|-----------------------|-----------------|------------------------------|-------------------------|
| Concrete | 26.5 | 0.2 | 45.1 | 4.18 |
| Steel | 200 | 0.3 | $\sigma_y = 520 \text{ Mpa}$ | |

Table 2 : Mazars model parameters

| Parameter | Description | Value |
|-----------|------------------------------------------|-------------|
| 'KTR0' | Threshold in deformation for the tension | 1.50943E-04 |
| 'ACOM' | Parameter for the compression | 1.276 |
| 'BCOM' | Parameter for the compression | 1060 |
| 'ATRA' | Parameter for the traction | 0.9 |
| 'BTRA' | Parameter for the traction | 11925 |
| 'BETA' | Correction for the shear | 1.06 |

Table 3 : DAMAGE_TC model parameters

| Parameter | Description | Value |
|-----------|---------------------------------------------|----------------------|
| 'HLEN' | Characteristic length (cf. mesh) | $\sqrt[3]{V_{elem}}$ |
| 'GVAL' | Fracture energy (J/m ²) | 120 |
| 'FTUL' | Tension limit strength (Pa) | 4.18E+06 |
| 'REDC' | Drop Factor for Peak Tensile Stress (Pa) | 2.92E+06 |
| 'FC01' | Elastic Limit Compressive Stress (Pa) | -1.00E+07 |
| 'RT45' | Equi-biaxial Compressive Ratio | 1.18 |
| 'FCU1' | Compressive Peak Stress (Pa) | -4.51E+07 |
| 'STRU' | Ultimate Limit Strain | -0.035 |
| 'EXTP' | Reference Strain for Plastic Parameter | -0.00153 |
| 'STRP' | Reference Stress for Plastic Parameter (Pa) | -3.00E+07 |
| 'EXT1' | Fitting Point 1 (Strain) | -0.003 |
| 'STR1' | Fitting Point 1 (Stress) (Pa) | -4.00E+07 |
| 'EXT2' | Fitting Point 2 (Strain) | -0.005 |
| 'STR2' | Fitting Point 2 (Stress) (Pa) | -3.00E+07 |
| 'NCRI' | Exponential softening in tension | 1 |

2.1.2 Modeling and discretization

In this work, the concrete is modeled with eight nodes 3D hexahedral elements. The reinforcement steel is modeled using 1D truss elements. The 1D-truss elements are only able to transfer the tension and compression forces, but not a bending moment. A perfect connection between this reinforcement bars and the concrete elements is also assumed.

Load and boundary conditions, were applied as nodal loads and constraints in the FE model (schematically shown in Figure 2-4). To prevent local failure of the concrete elements due to the concentration of high stresses in the vicinity of the supports and at the point of application of lateral load, the concrete behavior was assumed as linear elastic in these regions.

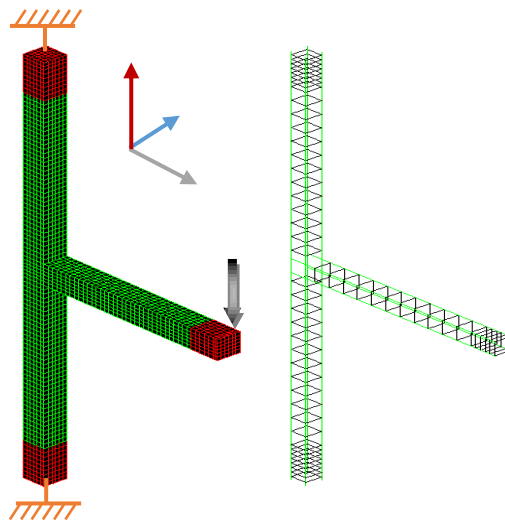

Figure 2-4: Modeling of exterior BC joint

2.1.3 Preliminary analyses

Figure 2-5 and Figure 2-6 show the results of the numerical local analysis of the exterior BC joint under monotonic loading. The numerical simulations show:

- Appearance of a plastic hinge in the beam at the beam-column interface as soon as the elasticity limit is exceeded.
- After formation of the plastic hinge, diagonal cracks through the joint region and cracks due to bending in beam are noted.
- Flexural yielding of the beam reinforcement bars occurred after joint shear cracking (brittle behavior).
- Ultimate strength and flexural yielding of bars predicted by Mazars model slightly exceeded DAMAGE_TC model, whereas Mazars behavior was more brittle.

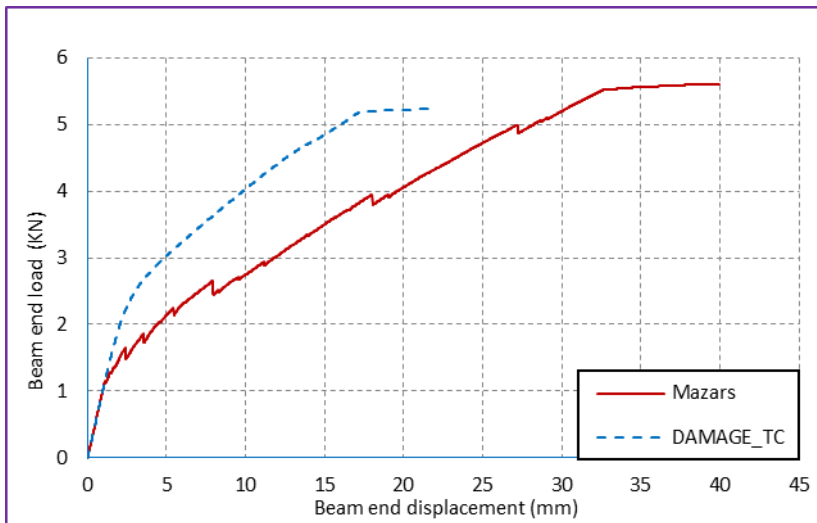
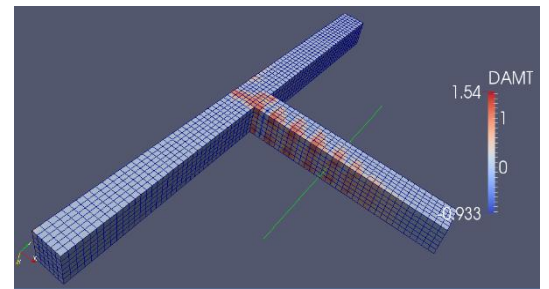
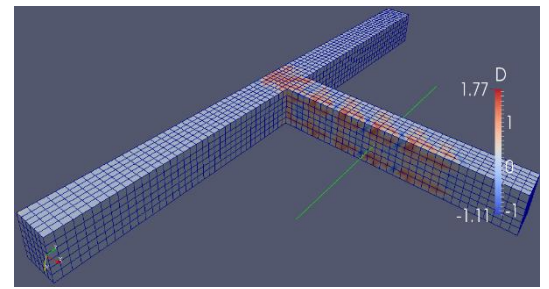

Figure 2-5 : Global response (monotonic loading)



(a) Mazars



(b) DAMAG_TC (in traction)

Figure 2-6: Cracking patterns: Monotonic loading (beam end displ.

Figure 2-7 and Figure 2-8 show the results of the numerical local analysis of the same joint under cyclic loading. In these simulations we can observed:

- Mazars model could not reproduce the hysteretic behavior because it doesn't take into account the unilateral effect and frictional sliding at the concrete crack interfaces.
- The hysteretic behavior predicted by DAMAGE_TC was symmetric and without permanent deformations.
- In the case of deformed bars, the assumption of a perfect bond between steel and concrete leads to a slight overestimation of the ultimate strength and a less realistic cracking pattern and post-peak behavior especially under cyclic loading if compared to the use of the discrete-bond model (Sharma, et al., 2009).

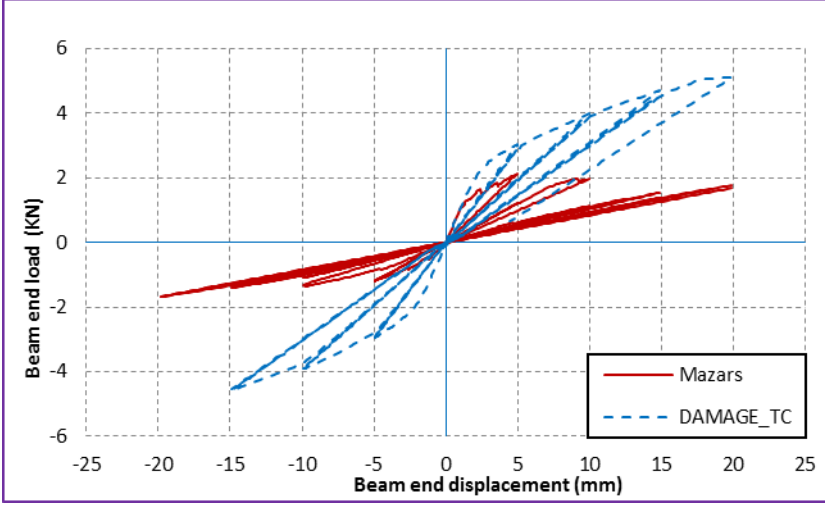
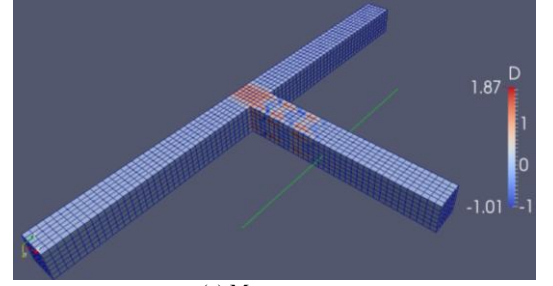
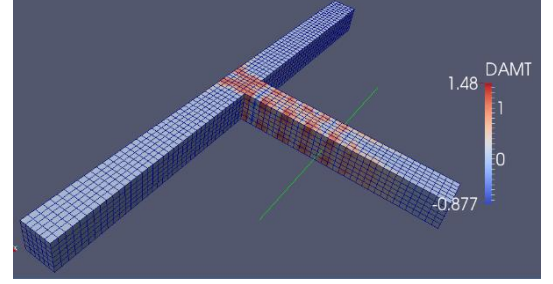

Figure 2-7 : Hysteretic behavior (cyclic loading)



(a) Mazars



(b) DAMAG_TC (in traction)

Figure 2-8: Cracking patterns:

Cyclic loading (beam end displ. ± 20 mm)

2.2 From 3D modeling to simplified macro-element model

Avoiding the high computational costs of classical three-dimensional (3D) analysis of RC structures, different kind of models can be adopted in order to reduce the structural kinematic complexity in describing the numerical responses of large-scale structures subjected to complex loadings (cyclic and seismic). Elements joints (beam-column and wall-slab connections) can be treated thanks to macro-elements linking global loads vector (Forces and Moments) to global kinematic variables (displacement and rotation) (Nguyen, et al., 2014).

2.2.1 Kinematics of connection element: finite element framework

The joint element used in our work contains three nodes (Figure 2-9). Each node has three degrees of freedom in 2D space: two displacements and one rotation. The vectors of nodal displacement \bar{U} and force \bar{F} of an element with three nodes have the form shown below. In general cases, the relation between the generalized displacements and forces (stiffness matrix) are directly computed using elastic beam theory.

$$\bar{U} = [U_x^1 \ U_z^1 \ R_y^1 \ U_x^2 \ U_z^2 \ R_y^2 \ U_x^3 \ U_z^3 \ R_y^3] \quad (1)$$

$$\bar{F} = [F_x^1 \ F_z^1 \ M_y^1 \ F_x^2 \ F_z^2 \ M_y^2 \ F_x^3 \ F_z^3 \ M_y^3] \quad (2)$$

$$\bar{F} = \bar{K}\bar{U} \quad (3)$$

Where \bar{K} is the stiffness matrix.

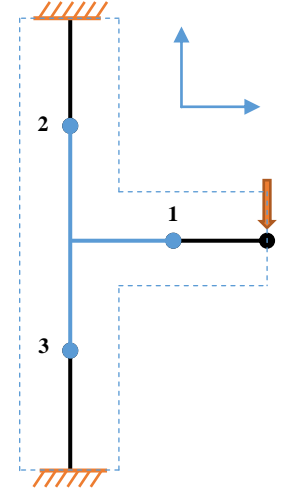

Figure 2-9: Proposed

2.2.2 Stiffness matrix of proposed macro-element

In order to find the different components of the stiffness matrix \bar{K} , based on 3D Finite Element numerical analyses (using elastic model for concrete and steel), we can set one component of the displacement vector \bar{U} to non-zero value (and at the same time set the other displacement components to zero), and evaluate the resulting reaction forces \bar{F} . The values components of the stiffness matrix column, corresponding to this component, can be calculated by dividing the reaction forces obtained by the imposed displacement value.

In order to find the stiffness matrix degradations $\tilde{K} = K(1 - D)$ of the proposed macro-element (during loading applied at beam tip in direction z), we need to know which components in the stiffness matrix will degrade during this loading. Therefore, firstly, we have done 3D analysis using Mazars model to obtain damage state of the joint. Secondly, we have done 3D analysis using elastic model for concrete with the value of the damage Young's modulus $\tilde{E} = E(1 - D)$. Figure 2-10 shows the evolution of stiffness matrix degradations for four increasing stages of the monotonic loading at beam tip in direction Z. **IL FAUT COMMENTER LES VALEURS OBTENUES**

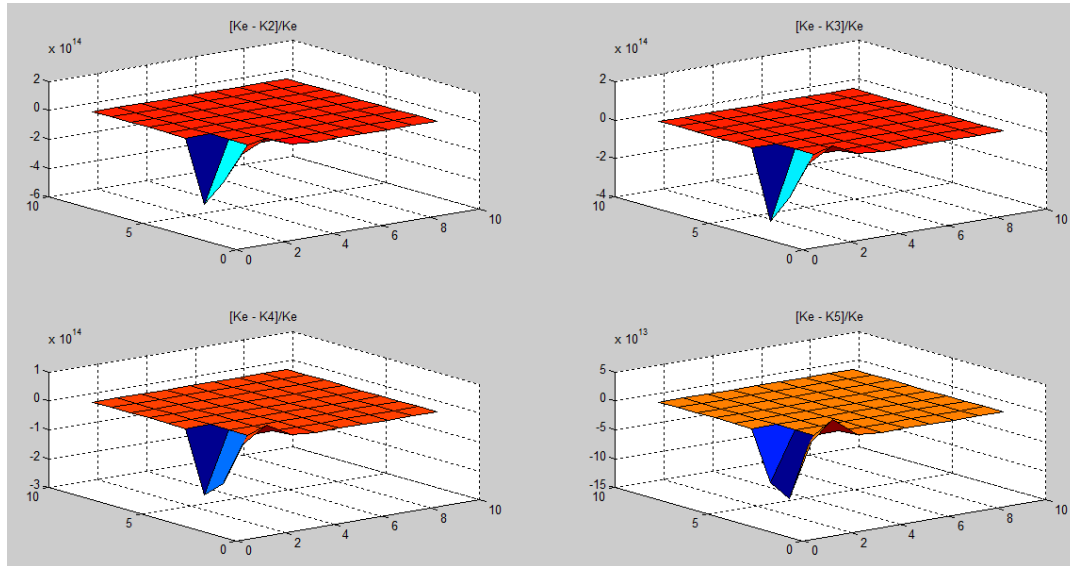

Figure 2-10 : Evolution of stiffness matrix degradations of the proposed macro-element

3 Experimental investigations

Many researchers carried out experimental investigations on monotonic and cyclic loading of beam-column joints in order to understand the behavior of RC beam-column joints (Hamil, 2000), (Youssef, et al., 2008), (Kam, et al., 2010). In this work, the experimental test series considered for the validation of the FE and macro-element models will include three or four exterior beam-column joint subassemblies designed without seismic detailing (i.e., without transverse reinforcement in the core) and subjected to different cyclic loadings (unidirectional and bidirectional displacement-controlled quasi-static) applied at the beam tip. The specimens have been designed, built, instrumented, tested, and analyzed in the LMT-Cachan.

3.1 Details of Specimens

All specimens will have similar properties (identical beam and column sizes). Until the date of preparation of this paper, only one specimen was manufactured. This specimen was designed to fit the machine capacity (Hexapod, Figure 3-2.) and to have a shear failure in the joint region before the yielding of beam or column reinforcement bars. Figure 3-1 shows the cross section and reinforcement configurations for the specimen.

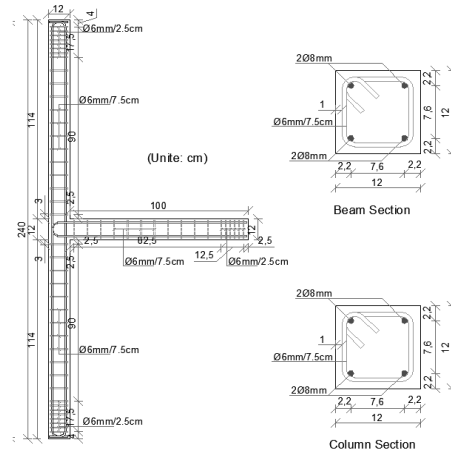

Figure 3-1: Reinforcement details of the

3.2 Test Setup and procedure

The test setups is shown in Figure 3-2. The specimen will be placed horizontally. Both two ends of the column will be fixed in all directions. The specimen will be cyclically loaded at beam tip in the horizontal plan. The loading consists of cycles at increasing displacement level with 2 cycles at each stage. The loading rate was chosen to reproduce quasi-static loading conditions. No axial load will be applied. A load cell (6 DOF) developed and calibrated will be used for loading and to get an

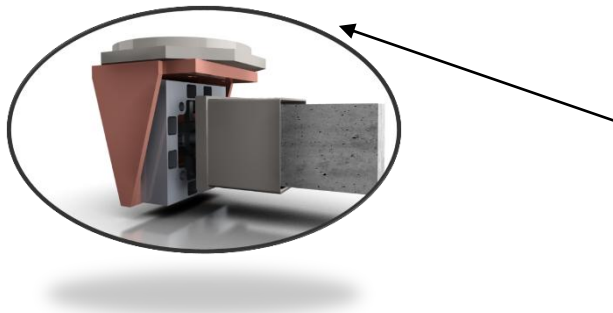

Figure 3-2: Test setup of the specimens

overall idea of displacement of the test body, displacement fields and cracking patterns a digital image correlation (Hild, 2002) will be used.

4 Conclusions

Considering the nonlinear behavior of beam-column connections in buildings, an experimental and numerical analysis of the mechanical response of exterior joint is proposed in this paper. Proposed experiment will allow to identify the behavior of connection under complex loading. Finite elements analysis based on 3D nonlinear behaviors helps one to discriminate the fundamental thermodynamic variables to be introduced and to evaluate their respective evolution laws linked to the global displacements. At last, a simplified model, based on the beam theory assumption is proposed to predict the nonlinear response of building connections subject to cyclic loading. Depending on the material parameters choices and identification, it can reproduce brittle to softener joints.

5 References

- Alath, S. & Kunnath, S. K., 1995. *Modeling inelastic shear deformations in RC beam-column joints*, s.l.: Stein, S. (Ed.): Engineering Mechanics: Proceedings of 10th Conference, University of Colorado at Boulder, May 21-24, 1995. New York NY: ASCE, 1995, pp. 822-825.
- Biddah, A. & Ghobarah, A., 1999. *Modelling of shear deformation and bond slip in reinforced concrete joints*, s.l.: Structural Engineering and Mechanics 7 (1999), No. 4, pp. 413-432.
- Braga, F. D. C. G., Gigliotti, R. & Laterza, M., 2001. *Modeling of the bond-slip behavior in the response mechanisms of RC beam-column joints with plain round bars*, s.l.: ANIDIS (Ed.): X Congresso Nazionale L'Ingegneria Sismica in Italia, Potenza-Matera, Sept. 9-13, Italy. Potenza: Lamisco, 2001. (In Italian).
- Costa, C., Pegon, P., Arêde, A. & Castro, J., 2004. *Implementation of the damage model in tension and compression with plasticity in cast3m*, s.l.: Report EUR, ISPC, CEC, JRC, Ispra (VA), Italia.
- Eligehausen, R., Genesio, G., Ožbolt, J. & Pampanin, S., 2009. *3D Analysis of Seismic Response of RC Beam-Column Exterior Joints before and after Retrofit*, s.l.: Alexander, M.G.; Beushausen, H.-D.; Dehn, F.; Moyo, P. (Eds.): Concrete Repair Rehabilitation and Retrofitting II: Proceedings of the 2nd Conference; Cape Town, South Africa, November 24-26, 2008. London: Taylor & Francis, 2009, pp. 407-408.
- Elmorsi, M., Kianoush, M. R. & Tso, W. K., 2000. *Modeling bond-slip deformations in reinforced concrete beam-column joints*, s.l.: Canadian Journal of Civil Engineering. 27 (2000), No. 3, pp. 490-505.
- Genesio, G. & Sharma, A., 2010. *Seismic retrofit solution for reinforced concrete exterior beam-column joints using a fully fastened haunch - Part 2-1: As-built joints*, s.l.: Stuttgart: IWB, University of Stuttgart, 2010. Test Report No. WS 221/07 - 10/01. (Not published).
- Hamil, S. J., 2000. *Reinforced Concrete Beam-Column Connection Behaviour*, s.l.: Durham, University, PhD Thesis.
- Hild, 2002. *A software for displacement field measurements by digital image correlation*, s.l.: Internal report N° 254. LMT-Cachan.
- Kam, W., Quintana Gallo, P., Akguzel, U. & Pampanin, S., 2010. *Influence of slab on the seismic response of sub-standard detailed exterior reinforced concrete beam column joints*, s.l.: University of Canterbury. Civil and Natural Resources Engineering.
- Lowe, J. & Altoonash, A., 2003. *Modeling Reinforced-Concrete Beam-Column Joints Subjected to Cyclic Loading*, s.l.: Journal of Structural Engineering 129 (2003), No. 12, pp. 1686-1697.
- Masars, J., 1984. *Application de la mécanique de l'endommagement au comportement non linéaire et à la rupture du béton de structure*, s.l.: PdD thesis, Université Pierre et Marie Curie.
- Nguyen, T., Ragueneau, F., Baho, D. & Ruau, N., 2014. *Macroscopic modeling of reinforced concrete joints: Application to thermal break elements subject to earthquake loadings*. s.l.: Engineering Structures 79 (2014) 131–141.
- Sharma, A., Genesio, G., Reddy, G. & Eligehausen, R., 2009. *Nonlinear dynamic analysis using microplane model for concrete and bond slip model for prediction of behavior of nonseismically detailed RCC beam-column joints*, s.l.: Journal of Structural Engineering 36 (2009), No. 4, pp. 250-257.
- Youssef, M. A., Alam, M. S. & Nehdi, M., 2008. *Experimental Investigation on the Seismic Behavior of Beam-Column Joints Reinforced with Superelastic Shape Memory Alloys*, s.l.: Journal of Earthquake Engineering, 12:1205–1222.