



HAL
open science

Sizing Criterion of QSP Parts Using a Virtual Testing Local Approach

Orestis Friderikos, Emmanuel Baranger, Damien Guillon

► **To cite this version:**

Orestis Friderikos, Emmanuel Baranger, Damien Guillon. Sizing Criterion of QSP Parts Using a Virtual Testing Local Approach. Journées Nationales sur les Composites 2017, École des Ponts ParisTech (ENPC), Jun 2017, 77455 Champs-sur-Marne, France. hal-01621583

HAL Id: hal-01621583

<https://hal.science/hal-01621583>

Submitted on 23 Oct 2017

HAL is a multi-disciplinary open access archive for the deposit and dissemination of scientific research documents, whether they are published or not. The documents may come from teaching and research institutions in France or abroad, or from public or private research centers.

L'archive ouverte pluridisciplinaire **HAL**, est destinée au dépôt et à la diffusion de documents scientifiques de niveau recherche, publiés ou non, émanant des établissements d'enseignement et de recherche français ou étrangers, des laboratoires publics ou privés.

Critère de dimensionnement de composites QSP basé sur une approche locale d'essais virtuels

Sizing Criterion of QSP Parts Using a Virtual Testing Local Approach

Orestis Friderikos¹, Emmanuel Baranger¹ et Damien Guillon²

1 : LMT, ENS Cachan, CNRS, Université Paris-Saclay
61 avenue du Président Wilson, 94235 Cachan, France
e-mail : friderikos@lmt.ens-cachan.fr et Emmanuel.BARANGER@lmt.ens-cachan.fr

2 : CETIM / pôle Ingénierie Polymères & Composite
Technocampus Composites Z.I. du Chaffault, 44340, Bouguenais, France
e-mail : Damien.guillon@cetim.fr

Résumé

L'objectif de ce travail est de fournir aux ingénieurs une méthodologie robuste permettant de déterminer les premiers stades d'endommagement pour des pièces obtenues par procédé QSP. Il s'agit d'une méthode globale-locale basée sur la décomposition d'une structure en composants élémentaires représentatifs. L'utilisation de la mécanique de l'endommagement à l'échelle mésoscopique est utilisée pour représenter la réponse locale de la structure. Pour cela, les conditions limites à imposer aux détails structuraux sont extraites et transférées à l'échelle locale. La partie suivante, essentielle, concerne la génération des différentes solutions locales pour lesquelles une métrique globale de perte de raideur est définie. L'enveloppe de rupture sera ensuite définie par une méthode de réduction de modèle. Celle-ci pourra être utilisée par la suite comme un critère de rupture traditionnel.

Abstract

The objective of this research is to provide design engineers with a robust methodology for determining the early stages of damage evolution in Quilted Stratum Process (QSP) composite parts and answer critical design questions on why, where, and when damage and fracture initiates. This work concerns a novel global-local multiscale method based on the decomposition of a global structure into representative structural components. Physics based composite damage and failure mechanisms are used to interrogate the structural response. Hence, the proposed software aims to augment FEA, with a hierarchical modeling that goes down to the meso-scale. A detailed modeling of each local structural component is performed using non-linear FEA (Abaqus/Standard). To accomplish this task, the loading conditions at the boundaries of the important structural details are extracted in order to be transferred to the local scale as boundary conditions for non-linear FEM computations. The essential part of the method concerns the generation of a design space for each local structure corresponding to the operating loading conditions extracted from the global structural computations. Model Order Reduction techniques can then be applied to define certain metrics of the structural stiffness loss as well as for design of failure envelopes. A key aspect of the method is that off-line computations for the representative structural components can be stored and used for different global scale structures.

Mots Clés : Approche globale/locale, modèles de zones cohésives, délamination,

Keywords : Global/local approach, cohesive zone models, delamination, Design of Computer Experiments (DCE)

1. Introduction

The Quilted Stratum Process (QSP) provides high-performance net shape parts by the thermoforming of an assembly of thermoplastic composite patches with unidirectional or woven reinforcements [1]. This high-speed production process offers the possibility of composite parts with complex shapes in a cost-efficient and automated way. The complexity of the QSP design process is due to the non-homogeneous nature of the stratification as well as on the mechanical behavior of structural details as for example the internal-ply drop-off tapers in which the drop ply is at the interior of the laminate. Stress concentrations resulting from fiber discontinuity across the ply interfaces (resin pockets) are likely to contribute to strength reduction in QSP laminates, and a key technical challenge to the

application of QSP design is in the management of potentially deleterious effects of the resin pockets. These discontinuities can be responsible for the early damage of the surrounding plies through stress transfer and delamination at the patch interfaces.

The overall goal of this effort is to perform certification-by-analysis (CBA), utilizing an accurate virtual testing approach in combination with a reduced physical test data to decrease the design cycle time and cost for QSP composite parts. To this end, failure criteria based on a tolerance of stiffness loss for the composite part in order to achieve a robust design are provided.

A damage analysis to determine the early stages of degradation evolution under service loading is introduced. Physics based composite damage and failure mechanisms are used to interrogate the structural response. Hence, the proposed software aims to augment FEA analysis, with a hierarchical modeling that goes down to the meso-scale. In order to handle the associated high level of complexity, a local structural analysis to determine failure and damage is proposed using the Damage Mesomodel for Laminates (DML) theory [2],[3] which provides a complete description of the degradation mechanisms at the meso-scale. This approach is already used by other research teams for QSP composite parts [4]. With the proposed modeling approach, the evaluation of damage and failure criteria are implemented at the important structural details (local) and appropriate stiffness degradation functions with a pre-defined tolerance are reflected in the structural stiffness. The advantage is not only that it relies on meso-mechanics laws, but also that it provides for each mechanism separate indicators (microcracking rate in particular) which can be easily interpreted in relation to experiments.

2. Multiscale global/local methodology

The multiscale methodology used here augments finite element software by providing progressive failure analysis based on damage tracking and material property degradation at the meso-scale, where damage and delamination have their source. Displacements/rotations or forces/moments derived from the structural scale FEA solution at specified boundaries of the RSC problems are passed to the local scale for high-non linear computations. Most FEA analysis, which are not augmented with multiscale analysis, evaluate failure at the lamina or laminate scale and do not pursue failure beyond this point. Unfortunately, failure does not originate at the lamina and laminate level and, instead, originates at lower scales. The multiscale global/local overall process is illustrated in Fig. 1 and can be summarized in the following steps :

1) A global structural analysis is realized to evaluate the global structural response to the operating design loads. These structures are modeled and analyzed using shell finite elements, to keep the modeling and computational effort affordable. During this step, the loading conditions at the boundaries of the important structural details are extracted in order to be transferred to the local scale as boundary conditions for non-linear FEM computations.

2) Decomposition of the composite part and the detailed modeling of the important structural components (e.g., stiffeners, tapering of the thickness of a laminate by terminate, or dropping, internal or external plies, corners) (see Fig. 1), henceforth called Representative Structural Component (RSC) problems is performed. These RSC problems can be modeled either by developing analytically shear-lag models or can be constructed using a FE analysis (Abaqus). In the later, solid or continuum shell elements with Cohesive Zone Models (CZM) are introduced to evaluate the various delamination modes at the finite element model [5]-[13].

3) Generation of the design space for the RSC problems is performed, i.e. the RSC problems are subjected to a set of loading conditions (displacements/rotations, forces/moments) corresponding to the operating loading conditions extracted from the global scale computations. Therefore, in order to efficiently explore the design space, Design of Computer Experiments (DCE) methods are introduced.

4) A Model Order Reduction method (SVD) is applied to the data of the design space obtained in the previous step in order to define a set of criteria describing the various failure modes of the RSC part. These criteria may involve not only the macroscopic loading but also the geometry of the laminate

defined by the local stacking sequence, the orientation of the plies, etc. Thus, it is possible to study the design limits of the criteria established vis a vis reference configurations to define the application of the model range. The definition of reference configurations will be the object of a preliminary study and may be extended by new configurations presented on other parts regarded as important.

5) Definition of a global stiffness loss tolerance for the RSC related to the design space defined using energy calculations (e.g. elastic recoverable energy) performed in the FEM software.

6) Design of failure envelops for a damaged state that corresponds to a predefined reduction of the RSC laminate global stiffness.

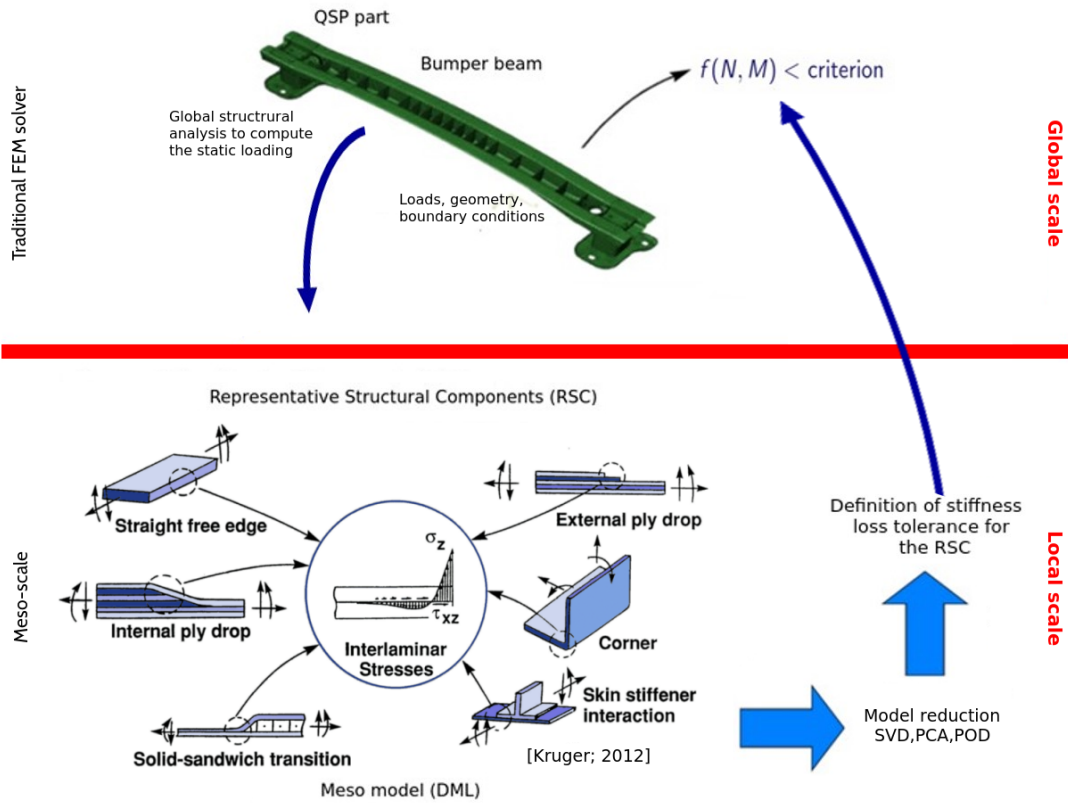

Fig. 1. Virtual Testing Analysis flowchart for QSP composite parts.

3. Cohesive Zone Modeling in Abaqus

3.1. Cohesive Zone Modeling (CZM)

The basic hypothesis of the CZM is that all the inelastic effects that occur at the vicinity of a crack can be lumped into a surface, the cohesive damage zone. Cohesive damage zone models relate tractions t to displacement jumps δ at an interface where a crack develops. Damage initiation is related to the nominal cohesive strength t^0 ; when the area under the traction-displacement jump relation is equal to the critical energy release rate, \mathcal{G}^c , the traction is reduced to zero and new crack surfaces are formed. The new crack surfaces are completely formed when the displacement jump is equal or greater than the displacement jump at complete failure δ^f . Using the definition of the J integral, it can be shown that for small cohesive zones [6]

$$\int_0^{\delta^f} t(\delta) d\delta = \mathcal{G}^c \quad (\text{Eq. 1})$$

A bi-linear triangular cohesive law for failure analysis is used for pure Mode I and pure Mode II

or Mode III. The form of the cohesive law is dependent on the corresponding cohesive strength, interfacial stiffness (penalty stiffness, K) and the critical strain energy release rate.

$$t = \begin{cases} K\delta, & \delta \leq \delta^\circ \\ (1-d)K\delta, & \delta^\circ < \delta < \delta^f \\ 0, & \delta \geq \delta^f \end{cases} \quad (\text{Eq. 2})$$

A mixed-mode criterion accounting for the effect of the interaction of the traction components in the onset of delamination is used. Damage initiation is predicted using a quadratic failure criterion considering nominal stresses where compressive normal tractions do not affect delamination onset :

$$\left\{ \frac{\langle t_n \rangle}{t_n^\circ} \right\}^2 + \left\{ \frac{t_s}{t_s^\circ} \right\}^2 + \left\{ \frac{t_t}{t_t^\circ} \right\}^2 = 1 \quad (\text{Eq. 3})$$

where t_s° , t_t° and t_n° are the nominal cohesive strengths in normal and the two shear directions, respectively and $\langle \cdot \rangle$ is the Macaulay bracket notation denoting the positive part.

In order to accurately account for the variation of fracture toughness as a function of mode ratio, a mixed-mode energy-based damage evolution criterion proposed by Benzeggagh and Kenane (BK) [14] is used. BK criterion is particularly useful when the critical fracture energies during deformation purely along the first and the second shear directions are the same (i.e. $\mathcal{G}_s^c = \mathcal{G}_t^c$)

$$\mathcal{G}^c = \mathcal{G}_n^c + (\mathcal{G}_s^c - \mathcal{G}_n^c) \left(\frac{\mathcal{G}_s}{\mathcal{G}_n + \mathcal{G}_s} \right)^n \quad (\text{Eq. 4})$$

where n is the semi-empirical criterion exponent applied to delamination initiation and growth.

Remark 1 : Material models exhibiting softening behavior and stiffness degradation often lead to severe convergence difficulties in implicit analysis programs. A common technique to overcome some of these convergence difficulties is the use of viscous regularization of the constitutive equations (local), which causes the tangent stiffness matrix of the softening material to be positive for sufficiently small time increments. A small value for the viscosity parameter, compared to the characteristic time increment, usually improves the convergence rate of simulations during the softening regime, without compromising the accuracy.

Remark 2 : Automatic stabilization method (global) in Abaqus/Standard improves convergence by using an automatic algorithm for the stabilization of locally unstable quasi-static problems by the automatic addition of volume-proportional damping to the model. In this scheme the damping factor can vary spatially and with time. Automatic stabilization scheme based on dissipated energy fraction (default Abaqus values) is used in the model.

3.2. Simulation of the debonding mechanisms of UD internal Ply Drop-off Laminates

Tapered laminated structures, which are formed by dropping off some of the plies at discrete positions over the laminate, have received much attention because of their structural tailoring capabilities, damage tolerance, and their potential for creating significant weight savings in engineering applications. The inherent weakness of this construction is the presence of material and geometric discontinuities at ply drop region that induce premature interlaminar failure at interfaces between dropped and continuous plies and may cause a significant loss of structural integrity. In the foregoing simulations, the geometry of the resin pocket is idealized to be right triangular shaped. This geometry represents a worst-case scenario, i.e. it is more prone to delamination than other triangular shapes (especially in the thin section). Hence, a minimization of the number of parameters needed to describe the ply-drop geometry is accomplished. Furthermore, the resin pocket is considered as a void in order to increase

the stress intensity factors in the local models. This promotes thin section delamination, while the onset and growth of interlaminar cracks in the thick section are both unaffected by the material/geometrical properties of the resin pocket.

The problem geometry depicted in Fig. 2 concerns a benchmark 10-mm-long and 2-mm-wide specimen. The model is simulated through prescribed displacements imposed at the free gauge length (thin ply drop section) of 2 mm length while the constraint gauge length (thick section) is 3 mm. The thick section is comprised of 3 composite 0° plies with uniform thickness of 1 mm. The drop off zone is corresponding to a tapered angle of approximately 18° . Three cohesive zones are considered for this structure. The finite element mesh for the 3D model of the debonding problem is modeled by ten layers of type C3D8 elements for each ply. Cohesive zone elements are used at the interface between the plies with thickness of 0.1 mm. The associated model size corresponds to a total of 46000 linear hexahedral elements of type C3D8 and 2000 linear hexahedral elements of type COH3D8 with a total number of 58149 nodes (see Fig. 3). The size of elements in the direction of crack propagation and in the transverse direction is 0.1 mm. Material properties of Celstran/Ticona/PA66 used in the model are as follows : $E_{11} = 104200$ MPa, $E_{22} = E_{33} = 5420$ MPa, $\nu_{12} = \nu_{13} = \nu_{23} = 0.34$, $G_{12} = G_{13} = G_{23} = 2022$ MPa. The elastic properties of the interface material are defined using uncoupled traction-separation behavior with interface stiffness of $K_{nn} = K_{ss} = K_{tt} = 1 \times 10^6$ MPa. A quadratic traction-interaction failure criterion is chosen for damage initiation in the cohesive elements ; a mixed-mode, energy-based damage evolution law based on the BK criterion is used for damage propagation. The relevant material data are as follows : $t_s^\circ = t_s^\circ = t_t^\circ = 40$ MPa, $\mathcal{G}_n^c = 2.2$ N/mm, $\mathcal{G}_s^c = \mathcal{G}_t^c = 3.0$ N/mm and $n = 1.57$.

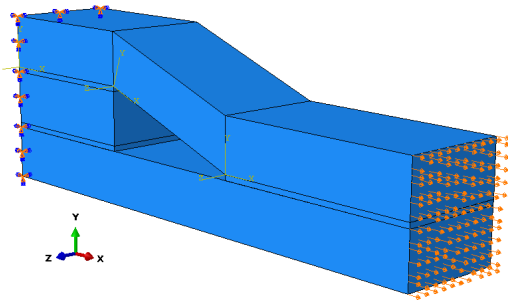

Fig. 2. Geometry of the benchmark ply drop model.

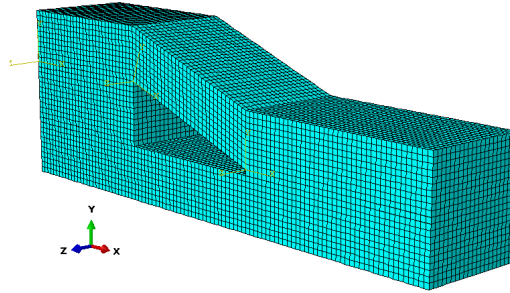

Fig. 3. Finite element model used in the laminate - Mesh of the benchmark ply drop model using cohesive elements.

A final state of the damage evolution of the benchmark ply drop model under static tensile loading is presented in Fig. 4. The scalar damage variable of the cohesive elements (SDEG) is used to represent the failure of the cohesive zones (red color identifies completely damaged elements). Delamination starts from the root of the ply drop (thin section) followed by delamination propagation at the two cohesive zones at the thick ply drop section. Displacement discontinuity in the longitudinal direction-1 indicates Mode II fracture in both cohesive zones (see Fig. 4.c) whereas displacement discontinuity in the transverse direction-2 resulting to Mode I fracture only in the ply drop thin section cohesive zone.

4. Latin hypercube sampling (LHS) benchmark example

Latin hypercube sampling (LHS) is a statistical method for generating a near-random sample of parameter values from a multidimensional distribution. The sampling method is often used to construct computer experiments or for Monte-Carlo integration. A design of experiments with N points and d dimensions is usually written as a $N \times d$ design matrix

$$\mathbf{X} = [\mathbf{x}_1, \dots, \mathbf{x}_k, \dots, \mathbf{x}_N]^T \in D^{N,d} \subset \mathbb{R}^{N,d} \quad (\text{Eq. 5})$$

where each column represents a variable and each row $\mathbf{x}_k = [x_k^{(1)} \dots x_k^{(2)} \dots x_k^{(d)}]$ represents a sample. A LHS design is constructed in such a way that each of the d dimensions is divided into equal levels

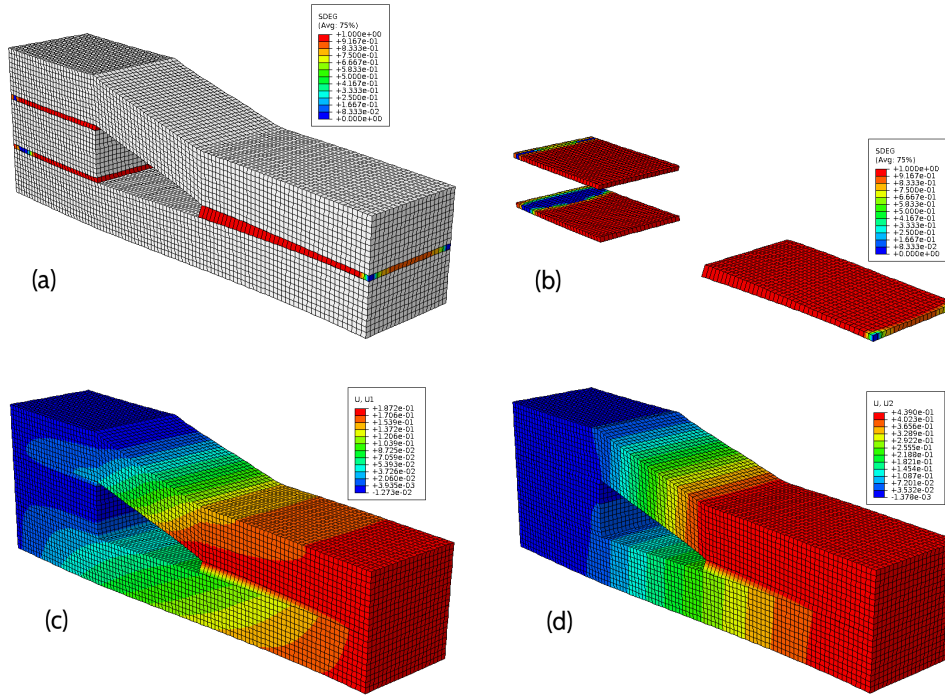

Fig. 4. Damage evolution of the benchmark ply drop model under static tensile loading ($u_x = 0.25$ mm); (a) (SDEG) Scalar damage variable of the cohesive elements (red color identifies completely damaged elements); (b) Detailed profile of the damaged cohesive surfaces; (c) Displacement discontinuity in longitudinal direction-1 (Mode II fracture); (d) Displacement discontinuity in the transverse direction-2 resulting to Mode I fracture only in the ply drop thin section cohesive zone.

(sometimes called bins) and that there is only one point (or sample) at each level. A random procedure is used to determine the point locations. Obviously, in a real world design of experiment, it is not possible to enlarge the necessary number of experimental designs to obtain acceptable space-filling and independency of the simulated design space which is important for an accurate sensitivity analysis and for design space exploration. So one of the main aims in the field of experiments is to obtain efficient Designs of Computer Experiments (DCE). LHS is an efficient DCE technique to construct computer experiments especially if the number of design variables is greater than $n > 5$ and general nonlinearities of the model responses are possible. Numerous modifications have been proposed for LHS to minimize correlation error and to ensure the unidimensional uniformity [15]-[18].

Fig. 5 shows the scatter plot of a two-dimensional Latin hypercube design created with the Matlab function lhsdesign (using default parameters) with $d = 2$ dimensions and $N = 20$ points. The design variables in this case corresponds to prescribed displacements u_x and u_y at the thin section of the RSC boundary. The corresponding limits for the prescribed displacements u_x and u_y (mm) are selected by performing preliminary computations in both directions where a complete delamination of the cohesive zones is almost occurred. Therefore, the following limits are considered for the sampling space : $u_x \in [-30, 25]$, $u_y \in [-25, 25]$. Two other auxiliary sampling points are selected corresponding to uniaxial tension and compression in x direction with $u_x = 0.25$ mm and $u_x = -0.35$ mm, respectively. Figures 6 and 7 presents a contour plot of the evolution of the damage dissipation energy E_{DMD} (ALLDMD) and the strain energy E_ϵ (ALLSE), respectively, with a superposition of the LHS design points. Based on energy computations, a measure of the RSC global stiffness loss can be defined. For purely elastic analysis, no plastic dissipation occurs and the internal energy is divided into :

$$E_I = E_\epsilon + E_{DMD} + E_{AE} \quad (\text{Eq. 6})$$

where E_I is the total internal energy (ETOTAL), E_ϵ is the elastic recoverable strain energy (ALLSE), E_{DMD} is the damage dissipation energy (ALLDMD) and E_{AE} (ALLAE) is the artificial strain energy

which is used to suppress singular modes like hourglassings indicating elements that undergo stress-free modes. To obtain reliable results, ALLAE energy term should be less than 1 – 2% of the internal energy. A metric of the Global Stiffness Loss (GSL) can be defined as :

$$GSL = \frac{\alpha^2 w_0 - w}{\alpha^2 w_0} = \frac{\alpha^2 \int_{\Omega} \epsilon_0 : \mathbb{C}_0 : \epsilon_0 dV - \int_{\Omega} \epsilon_n : \mathbb{C} : \epsilon_n dV}{\alpha^2 \int_{\Omega} \epsilon_0 : \mathbb{C}_0 : \epsilon_0 dV} \quad (\text{Eq. 7})$$

where \mathbb{C}_0 and \mathbb{C} are the initial and damaged global stiffness at state n , respectively, $\alpha = \epsilon_n / \epsilon_0$ is a parameter in order to scale the elastic strain energy density w_0 at the state corresponding to strain ϵ_0 (no damage) to a damaged state n corresponding to strain ϵ_n . However, it has to be mentioned that the monotonicity of GSL is not satisfied in the general case, and thus special considerations must be taken into account. Using certain metrics as the GSL criterion, a percentage of stiffness loss (for example 10%) can be defined as a design limit.

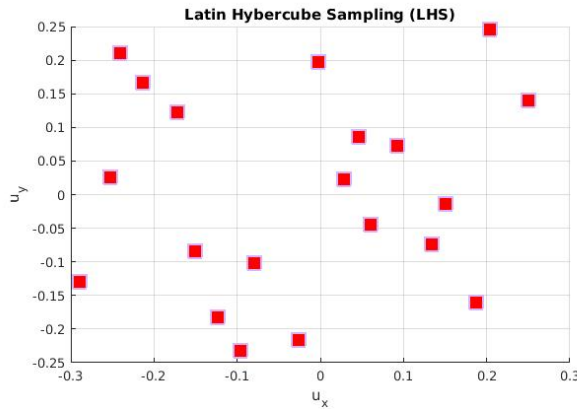

Fig. 5. 20 points of an orthogonal array based Latin hypercube sample. The design variables corresponds to prescribed displacements u_x and u_y .

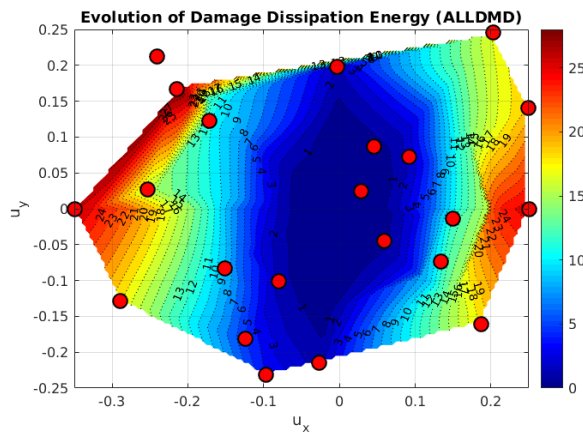

Fig. 6. Contour plot of the damage dissipation energy E_{DMD} (ALLDMD) with a superposition of the LHS design points.

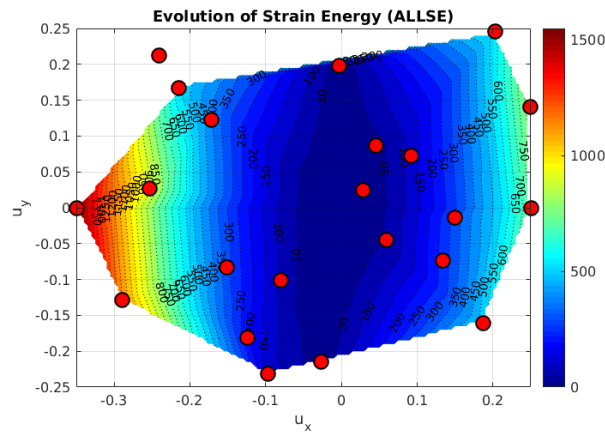

Fig. 7. Contour plot of the strain energy E_ϵ (ALLSE) with a superposition of the LHS design points.

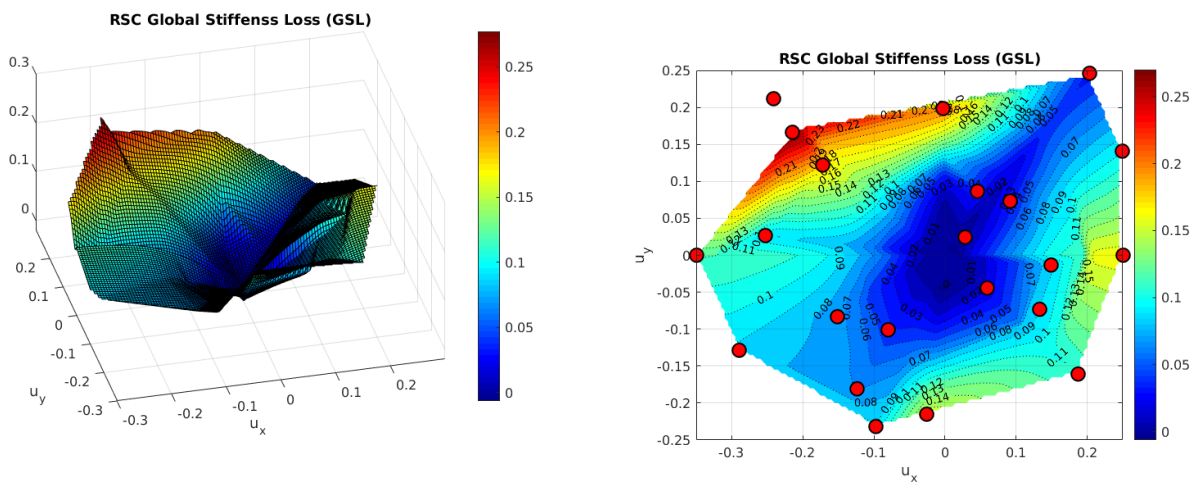

Fig. 8. Surface and contour plot of the RSC global stiffness loss (GSL) defined in (Eq. 7) with a superposition of the LHS design points.

5. Conclusions and Perspectives

A novel global-local multiscale method based on the decomposition of a global structure into representative structural components is introduced. This approach aims to augment FEA analysis with a hierarchical modeling that goes down to the meso-scale where damage and delamination originates. At the current stage, only delamination failures are taken into account for the multiscale computations whereas other mechanisms described at the meso-scale can be also incorporated into the model. Preliminary results using cohesive zone modeling showed the complex combination of mixed mode failure patterns in a simple benchmark internal ply drop model. Furthermore, a 2D LHS design was used for the definition of appropriate metrics of the global structural stiffness loss. At a next stage, Model Order Reduction methods will be applied to high dimensional spaces in order to provide design limits and failure envelopes for the design process of QSP composite parts.

Références

- [1] D. Guillon, A. Lemaçon, C. Callens, «QSP : An innovative process based on tailored preforms for low cost and fast production of optimized thermoplastic composite parts». *ECCM17-17th European Conference on Composite Materials*, Germany, 2016.
- [2] Ladevèze P., «About the damage mechanic of composites». In : Bathias C, Menkès D, editors. *Comptes-rendus des JNC5*, Paris : Pluralis Publication, pp. 667-83 [in French], 1986.

- [3] O. Allix, P. Ladeveze, «Interlaminar interface modeling for the prediction of delamination». *Composite Structures*, Vol. 22, pp. 235-242, 1992.
- [4] Y. Todeschini, C. Huchette, C. Julien, D. Espinassou, «Analysis of damage and failure mechanisms of Quilted Stratum Process composite parts». *ECCM17-17th European Conference on Composite Materials*, Germany, 2016.
- [5] R. Krueger, «Development of benchmark examples for quasi-static delamination propagation and fatigue growth predictions». *SIMULIA Community Conference*, Providence, RI, May 14-17, 2012.
- [6] Camanho, P.P., Davila, C.G., Ambur, D.R., «Numerical Simulation of Delamination Growth in Composite Materials». *NASA TP-2001-211041*, 2001.
- [7] C.G. Davila, P.P. Camanho, A. Turon, «Cohesive Elements for Shells, *NASA/TP-2007-214869*, 2007.
- [8] P.P. Camanho, C.G. Davila, «Mixed-Mode Decohesion Finite Elements for the Simulation of Delamination in Composite Materials». *NASA/TM-2002-211737*, 2002.
- [9] P.P. Camanho, C.G. Davila, M.F. De Moura, «Numerical Simulation of Mixed-mode Progressive Delamination in Composite Materials». *Journal of Composite Materials*, 37(16), 2003.
- [10] A. Turon, P.P. Camanho, J. Costa, J. Renart, «Accurate simulation of delamination growth under mixed-mode loading using cohesive elements : Definition of interlaminar strengths and elastic stiffness». *Composite Structures*, 92, 1857-1864, 2010.
- [11] De Xie, M. Garg, D. Huang, F. Abdi, «Cohesive Zone Model for Surface Cracks using Finite Element Analysis». *49th AIAA/ASME/ASCE/AHS/ASC Structures, Structural Dynamics and Materials Conference*, 7-10 April, Schaumburg, IL, 2008.
- [12] Krueger R., M. K. Cvitkovich, T. K. O'Brien, P.J. Minguet, «Testing and Analysis of Composite Skin/Stringer Debonding under Multi-Axial Loading». *Journal of Composite Materials*, 34(15), 1263-1300, 2000.
- [13] Reeder J., S. Kyongchan, P.B. Chunchu, D.R. Ambur, «Postbuckling and Growth of Delaminations in Composite Plates Subjected to Axial Compression». *43 rd AIAA/ASME/ASCE/AHS/ASC Structures, Structural Dynamics, and Materials Conference*, Denver, Colorado, 1746, 10, 2002.
- [14] Benzeggagh ML, Kenane M, «Measurement of mixed-mode delamination fracture toughness of unidirectional glass/epoxy composites with mixed-mode bending apparatus». *Composites Science and Technology*, 56 :439-449, 1996.
- [15] A.B. Owen, «Orthogonal arrays for computer experiments, integration and visualization». *Statistica Sinica*, 2, 439-452, 1992.
- [16] Koehler J.R., Owen A.B., «Computer Experiments». *Handbook of Statistics (Ghosh, S. and Rao, C. R., eds.)*, Elsevier Science, New York, 261-308, 1996.
- [17] M.D. McKay, R.J. Beckman, W. J. Conover, «A comparison of three methods for selecting values of input variables in the analysis of output from a computer code». *Technometrics*, 21(2), 1979.
- [18] B. Tang, «Orthogonal array-based Latin hypercubes». *Journal of the American Statistical Association*, 88(424), 1993.