



HAL
open science

A supercritical tuneable process for the selective extraction of fats and essential oil from coriander seeds

Houcine Mhemdi, Élisabeth Rodier, Nabil Kechaou, Jacques Fages

► To cite this version:

Houcine Mhemdi, Élisabeth Rodier, Nabil Kechaou, Jacques Fages. A supercritical tuneable process for the selective extraction of fats and essential oil from coriander seeds. *Journal of Food Engineering*, 2011, 105 (4), p. 609-616. 10.1016/j.jfoodeng.2011.03.030 . hal-01618293

HAL Id: hal-01618293

<https://hal.science/hal-01618293>

Submitted on 15 Nov 2017

HAL is a multi-disciplinary open access archive for the deposit and dissemination of scientific research documents, whether they are published or not. The documents may come from teaching and research institutions in France or abroad, or from public or private research centers.

L'archive ouverte pluridisciplinaire **HAL**, est destinée au dépôt et à la diffusion de documents scientifiques de niveau recherche, publiés ou non, émanant des établissements d'enseignement et de recherche français ou étrangers, des laboratoires publics ou privés.

A supercritical tuneable process for the selective extraction of fats and essential oil from coriander seeds

Houcine Mhemdi^{a,b}, Elisabeth Rodier^a, Nabil Kechaou^b, Jacques Fages^{a,*}

^a Université de Toulouse, Ecole des Mines Albi, RAPSODEE Centre, CNRS, F-81013 Albi, France

^b Université de Sfax, Ecole Nationale d'Ingénieurs de Sfax, Groupe de Recherche en Génie des Procédés Agroalimentaire, Unit MFAM, 02/UR/11-02, 3038 Sfax, Tunisia

A B S T R A C T

A selective supercritical CO₂ extraction process has been developed in order to extract selectively the vegetal oil and the essential oil from coriander seeds in a consecutive way by tuning experimental conditions. A 4 step process has been set up: (i) seeds preparation by grinding and sieving, (ii) extraction by supercritical CO₂ and (iii; iv) selective separation in two separators with different pressure levels. The first part of this study consisted in studying the effects of the operating conditions (T, P, CO₂ density, flow rate and particle size distribution of ground seeds) on the yield of extraction. The results showed that the global performance of the process depends mainly on the pressure level of extraction, on the CO₂ flow rate and on the size of the ground seeds. An optimization of the parameters led to an extraction ratio of 90%. The second part of this study dealt with the effects of the operating conditions on the quality of extracts, and more precisely on their composition in vegetal oil and essential oil. It was observed that the supercritical extraction had no major effect on the fatty acid composition of the vegetal oil compared to classical extraction techniques, while essential oil is enriched in components such as linalool and that a previous drying of the seeds is deleterious. Finally, we propose a procedure in order to extract separately each oil by adjusting CO₂ density and separation conditions.

Keywords:

Coriander seeds
Vegetal oil
Essential oil
Supercritical CO₂
Selective extraction

1. Introduction

Coriander (*Coriandrum sativum* L.) is an annual *Apiaceae* (*Umbel liferae*) herb, which is widely used in food (Aluko et al., 2001; Burdok and Carabin, 2009), pharmaceutical (Jabeen et al., 2009) and cosmetic (Eyres et al., 2005) industries.

Coriander fruits contain vegetal oil (VO) with a high concentration of monounsaturated fatty acids, especially of petroselinic acid (C18:1 cis Δ^6). This acid can be oxidatively cleaved to produce a mixture of lauric acid (C12:0), a compound useful in the production of detergents, and adipic acid, a C6 dicarboxylic acid, which can be utilized in the synthesis of nylon polymer (Msaada et al., 2009b). Moreover, the essential oil (EO) of coriander has been shown to have antibacterial (Kubo et al., 2004; Matasyoh et al., 2009), antioxidant (Wangensteen et al., 2004), antidiabetic

(Gallagher et al., 2003), anticancerous and antimutagenic (Chithra and Leelamma, 2000) activities.

There are three major extraction techniques used to obtain VO and EO from coriander seeds, which are steam distillation, organic solvent extraction (Soxhlet), and supercritical fluid extraction. Each technique has its benefits and drawbacks as far as operating cost, capital cost, yield and quality of the extracts are concerned. Steam distillation is by far the most widely used and the cheapest way of extraction, but it is limited to EO production, and it may induce chemical changes in the extract by oxidation of some compounds (Anitescu et al., 1997; Donelian et al., 2009; Msaada et al., 2007). Organic solvent extraction is intermediate in capital and operating cost, and is used for producing VO from oilseeds. However, concerns about the solvent residues in the oleoresin products, the new regulations of volatile organic solvent emissions in the air, and the extent of further refining that is required after the extraction step restrain the use of this technology (Catchpole and Grey, 1996). Supercritical fluid extraction is the most recent technology that is of increasing importance in the production of EO, VO, and a range of other substances from natural products (Brunner, 2005; Mohamed and Mansoori, 2002; Temelli, 2009). This technique has the highest capital cost of the three techniques, and moderate operating costs. However, neither solvent residues remain in the product after extraction, nor there are any chemical

Abbreviations: Bi, Biot number; *d*, diameter (m); *D*, diffusivity (m²/s); EO, essential Oil; ER, extraction ratio (%); EY, extraction yield (%); FA, fatty acid; *K*, mass transfer coefficient (m/s); *m*, mass of the extract (g); MUFA, monounsaturated fatty acid; *P*, pressure (Pa); PUFA, polyunsaturated fatty acid; *Q*, flow rate of CO₂ (kg/h); FA, saturated fatty acid; *T*, temperature (°C); VO, vegetal oil; ρ , CO₂ density (kg/m³); σ , standard deviation.

* Corresponding author. Tel.: +33 (0)5 63 493 141; fax: +33 (0)5 63 493 025.

E-mail address: jacques.fages@mines-albi.fr (J. Fages).

changes due to the processing technique, which gives extract of outstanding quality (Boutin and Badens, 2009; Brunner, 2005; Catchpole and Grey, 1996; Machmudah et al., 2008; Donelian et al., 2009; Perrut and Clavier, 2003).

The review of literature shows that most of the research works related to the extraction of coriander seeds are aimed at extracting either the VO (Msaada et al., 2009a,b) or the EO (Bandoni et al., 1998; Grosso et al., 2008; Illés et al., 2000; Msaada et al., 2007). The aim of this work is to put forward a new process using supercritical carbon dioxide, which is able to extract selectively the VO and the EO in a consecutive way by tuning experimental conditions. The effects of operating conditions on the yield of extraction and on the quality of extracts will be also studied to optimize the process.

2. Materials and methods

2.1. Raw material

Coriander seeds came from Canada and were provided by the laboratory of General Herbalism, Marseille, France. The seeds used were mature and brown. They were stored in a refrigerator at 4 °C before use. The moisture content was about 10%. Their mass content of VO and EO, respectively determined by Soxhlet and steam distillation were 20.8% (w/w) of VO and 0.4% (w/w) of EO. Hence, EO represents 1.9% (w/w) of the total oil content. The crushed coriander seeds (mean size 0.3 mm) were used for Soxhlet and steam distillation extraction of EO and VO. The extraction was carried for a long time (6 h for VO extraction and 90 min for EO extraction) to ensure total oil extraction. The supercritical extraction fluid was carbon dioxide (purity 99.995%, w/w) purchased from Air liquide S.A., Paris, France.

2.2. Particle size reduction

In mature coriander seeds, the oil is homogeneously distributed and it is bounded by cell membranes. Crushing the seeds may damage some cell membranes leading to the release of some oil and facilitating the extraction step. To study the effect of particle size on the extraction ratio, coriander seeds were first crushed. The grinding was performed using a grinder type IKA M20. The particle size distribution of ground seeds was determined by sieving. Size fractions were then obtained using sieves with an aperture size of 200 µm, 400 µm, 630 µm, 800 µm and 1 mm. Afterwards, three different fractions were used for extraction, having a mean size of 0.3 mm, 0.515 mm (named 0.5 in the following sections) and 0.9 mm.

2.3. Experimental set up and protocol for extraction

Supercritical CO₂ extraction experiments on coriander seeds were carried out on the pilot scale apparatus (Separex, France) shown schematically in Fig. 1. The mass of ground and sieved coriander seeds used in each experiment was approximately 50 g.

The pilot scale tests were performed by flowing carbon dioxide at the required temperature and pressure through a bed of ground coriander contained in the extractor (8). A backpressure regulator controlled the pressure in the extractor and temperature was regulated by an electrical device. The carbon dioxide and dissolved solute was then depressurized causing desaturation and condensation of VO into the first cyclonic separator (S1), which was held at a pressure of 7 MPa and a temperature of 30 °C. Then carbon dioxide flowed through a needle valve causing desaturation and condensation of the remaining EO and water into the second cyclonic separator (S2). This last vessel was maintained at a pressure of 4 MPa

and a temperature of 10 °C. After the extraction step, a yellow VO, was recovered in separator 1 (S1) and a fragrant EO is collected in separator 2 (S2). Extracts were sampled every 15 min from the separation vessels in order to follow the kinetics of extraction. The experiment was stopped when the amount extracted remained constant (i.e. once the derivative of the mass of extract in function of time, dm/dt , was lower than 0.005 g/min) and a plateau was reached on the extraction kinetics.

2.4. Chromatographic analysis

2.4.1. Fatty acid composition of vegetal oil

The fatty acid composition of the coriander VO was determined by analysis of their methyl esters obtained by transesterification. These esters were analyzed using a gas chromatograph type Varian CP select CB 3900 equipped with a silica capillary column (50 m × 0.25 mm × 0.25 µm). Temperature was held at 185 °C for 4 min, raised to 250 °C at 15 °C/min. The injection and the detector temperatures were both 250 °C. The carrier gas was H₂ (1.2 mL/min). The device was equipped with a FID detector (lowest detectable quantity: 5 pg of C), which gave the chromatogram for each sample. The identification of fatty acids was made by comparing their retention times with those of standard samples. Their mass content was calculated by assuming that the total peaks area account for 100% of the constituents.

2.4.2. Composition of essential oil

The separation of volatile components of the coriander EO was performed using a gas chromatograph capillary type HP 5890 series II, equipped with a DB 5MS column (30 m × 0.25 mm × 0.25 µm), a detector of flame ionization (FID) and injector EPC (electronic pressure control). The tests were conducted according to the following conditions. The column was held at 40 °C for 5 min and then increased at 5 °C/min up to 280 °C over 53 min. The solvent was dichloromethane and the flow through the column was 1.3 mL/min. The FID detector was held at 300 °C. The head pressure of the column was 0.1 MPa and the amount injected was 0.5 µL. The identification of the different components of EO was made by calculating the retention index and Kovats index and by comparing them with those of the literature.

2.5. Theory and calculation

2.5.1. Extraction yield and extraction ratio

In this study, the extraction yield (EY) is defined as the total mass of extract recovered from 100 g of coriander. It is expressed in% (g of extract/100 g coriander). The extraction ratio (ER) is the ratio in mass percent of oil extracted over the total quantity of oil contained in the seeds of coriander.

2.5.2. Mass transfer parameters

The supercritical fluid extraction implies the mass transfer of the VO and EO from coriander seeds to the flowing carbon dioxide. It is then important to understand this phenomenon and to appreciate its extent. This requires to estimate the parameters associated to mass transfer, such as the diffusivity of the components to be extracted, D , resulting from the diffusive internal transfer inside the seeds, the mass transfer coefficient, K , resulting from the convective transfer at the seeds surface and the Biot number, Bi , comparing both transfers.

The model used in this work to describe supercritical carbon dioxide extraction of oils from coriander seeds was developed by Goto et al. (1993, 1994). It is applicable to both essential and vegetable oil. This model considers coriander seeds like a porous solid containing EO associated with lipids located in vesicles (subsequent pores when opened). Internal mass transfer of oils implies

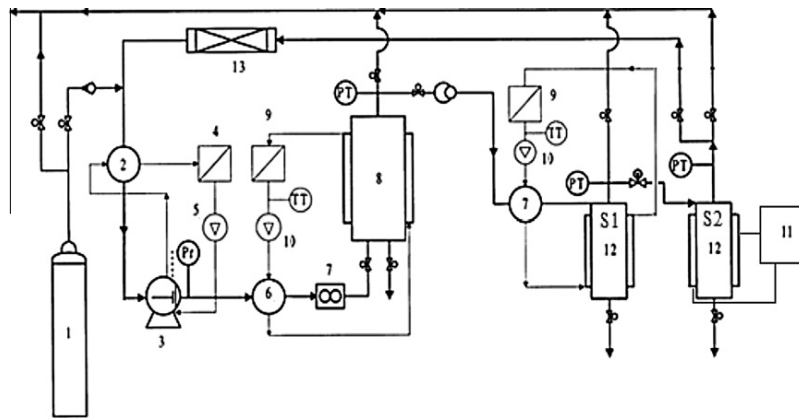

Fig. 1. Pilot scale extraction apparatus. 1 – CO₂ cylinder; 2 – condenser; 3 – CO₂ pump; 4 – refrigerator tank; 5 – refrigerator pump; 6 – heaters; 7 – mass flow meter; 8 – extractor; 9 – heating baths; 10 – pumps of heating systems; 11 – cooling bath; 12 – separators (S1 and S2); 13 – filter; Pr – pressostat; PT – pressure transmitter; TT – temperature transmitter.

a desorption of the molecules from the pores walls, internal diffusion through fluid inside the pores and a convective transfer at the seeds surface through the supercritical rich phase to be carried away by bulk flow. The adsorption desorption equilibrium is supposed to be established instantaneously. In addition, the solute concentration at the contacting surface between pores outlet (at the seeds surface) and surrounding CO₂ is unknown. The following assumptions have been made: no axial or radial dispersion, constant solvent density and constant flow rate through the bed. Extracted oils are considered as the major components of coriander seeds and both VO and EO are considered here as pure components.

2.5.2.1. Diffusivity D . To calculate the diffusion coefficient D of extracted oils in the coriander seeds, we used a mathematical model developed by Goto et al. (1993). This model gives a relationship between experimental extraction ratio and the extraction time and it allows the estimation of the effective diffusivity from experimental data. It has already been successfully applied by Catchpole and Grey (1996) to determine the values of diffusivity of oil through coriander seeds during supercritical CO₂ extraction. The relation ship is as follows:

$$\ln(1 - \text{ERT}/100) = -15Dt/r^2 \quad (1)$$

Here ERT is the extraction ratio at time t , r is the radius of coriander particles and D is the diffusivity. The slope of the curve $\ln(1 - \text{ERT}/100)$ versus t allows calculating the diffusivity.

2.5.2.2. Mass transfer coefficient K . The coefficient of external mass transfer (K) has been calculated by applying a correlation described by Brunner (1994). This correlation links the dimensionless numbers of Schmidt (Sc), Reynolds (Re) and Sherwood (Sh) and it is applicable for the extraction of oilseeds for $3 < Re < 3000$.

$$Sh = 2 + 1.1Sc^{1/3}Re^{0.6} \quad (2)$$

2.5.2.3. Biot number Bi . The Biot number (Bi) is a dimensionless number used for either heat or mass, internal and external transfers comparison. It is calculated by using relation 3:

$$Bi = Kd/D \quad (3)$$

Here K is the mass transfer coefficient, d the diameter of coriander particles and D the diffusivity.

2.5.3. Residence time

The residence time is the time taken by the CO₂ to flow through the bed of coriander. It is equal to the total coriander bed volume divided by the volumetric flow rate of carbon dioxide under extraction conditions.

2.6. Statistical analysis

To study the effects of particle size, flow rate, pressure, temperature and CO₂ density on the extraction ratio, the Fisher's least significant difference (LSD) test was applied. Each experiment was repeated thrice (1, 1a and 1b). Means and standard deviations were calculated (Table 2). Statistical analyses were carried out using the software Statgraphics® Plus 5.1 (Statpoint TechnologiesInc, USA) and for each analysis, significant level of 5% was assumed.

3. Results and discussion

3.1. Operating conditions and reproducibility of the results

Different operating conditions were used to study the influence of the pressure, the temperature, the density and the flow rate of CO₂ and the mean particle size of ground seeds to be processed on the extraction ratio and the composition of the extract. The tested operating conditions are gathered in Table 1. Experiment 9 is similar to experiment 1, except that seeds were previously dried at 70 °C and 60 kPa for 24 h.

Results of extraction ratio and mass transfer characteristics are gathered in Table 2. Three experiments were performed using the same experimental conditions, which are experiment 1a, 1b and 1c. The extraction ratios result in a mean value of 0.845 ± 0.016 . Statistical analysis shows that there is no significant difference at the 5% error level. In addition, the evolution of the weight of extract with time is similar for the three experiments. Hence, the reproducibility is satisfying.

3.2. Effect of the operating conditions on extraction yield

3.2.1. Influence of the particle size

The study of the effect of the particle size on the extraction ratio (Fig. 2 and Table 2) shows that reducing the particle size from 0.9 mm (experiment 3 in Table 1) to 0.5 mm (experiment 1 in Table 1) improves significantly the extraction ratio from 31% to 85%.

Table 1
Supercritical fluid extraction experiments: operating conditions.

Experiment	Operating conditions			Q CO ₂ (kg/h)	d (mm)	Extraction time (min)
	Extractor		ρ CO ₂ (kg/m ³)			
	P (MPa)	T (°C)				
1a; 1b; 1c*	21	35	873.67	1	0.5	300
2	10	35	712.81	1	0.5	330
3	21	35	873.67	1	0.9	300
4	21	35	873.67	1	0.3	300
5	21	45	822.91	1	0.3	300
6	21	55	767.88	1	0.3	300
7	21	35	873.67	1.5	0.3	300
8	21	35	873.67	2	0.3	300
9**	21	35	873.67	1	0.5	300
10 α ***	8	35	419.09	1	0.5	60
10 β ***	21		873.67			240

* Experiments 1a, 1b and 1c were performed using the same experimental conditions in order to test the reproducibility of results.

** Experiment 9 was performed in the same experimental conditions as experiment 1, except that the seeds were previously dried at 70 °C and 60 kPa for 24 h.

*** Experiment 10 was performed in two steps with 2 pressure levels: first step (10 α) at 8 MPa for 60 min and then step 2 (10 β) at 21 MPa for 240 min.

Table 2
Supercritical fluid extraction experiments: extraction ratio, statistical analysis and mass transfer parameters.

Experiment	Results			D (m ² /s) (10 ⁻¹³)	K (m/s) (10 ⁻⁵)	Bi (10 ⁵)
	Statistical analysis					
	ER (%)	σ	LSD tests			
1	84.5	1.6	a	1		
2	23.5	0.45	b	0.5		
3	31.3	0.6	c	0.1		
4	88.3	1.9	a,d	1.1	4.8	1.31
5	91.5	1.8	d			
6	90.0	1.7	d			
7	72.6	1.4	e		5.6	11.8
8	61.1	1.2	f		6.3	14.4
9	80.0	1.2	g			
10 α	2.0	0.1	h			
10 β	82.0	1.5	a,g			

*a, b, c, d, e, f, g and h means that experiments with the same superscript letters were not significantly different while those with different superscript letters are significantly different (LSD test, 5% level).

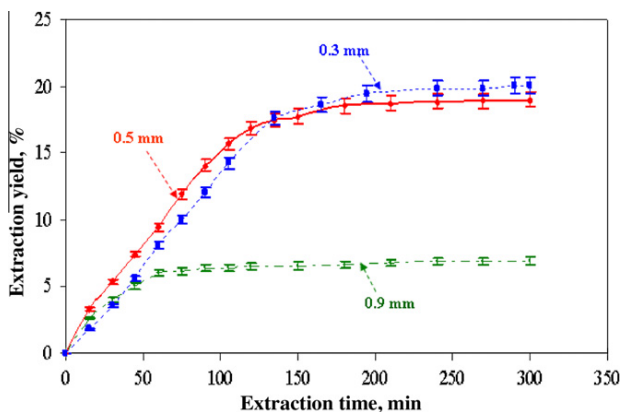

Fig. 2. Effect of particle size on the extraction yield in function of time for P = 21 MPa, T = 35 °C and Q = 1 kg/h.

This behavior can be attributed to the increase of the contacting area and to the decrease of the mass transfer limitations. Measurements of the specific surface area have been performed applying

the BET method to a krypton adsorption isotherm. They have led to values of 0.13 m²/g and 0.65 m²/g, respectively for 0.9 mm and 0.5 mm particle size fraction, which confirm the change in specific surface area with particle size. Similarly, the effective diffusivity is estimated to be 10⁻¹³ m²/s for a mean particle size of 0.5 mm while for a diameter of 0.9 mm it is 10 times smaller at 0.1 × 10⁻¹³ m²/s. These results are similar to those obtained by Catchpole and Grey (1996) and Grosso et al. (2008).

Increasing the extraction ratio when the particle size decreases may be also attributed to the modification of the internal structure of coriander seeds after grinding. Indeed, the oils are stored inside vesicles. After grinding, these vesicles may be damaged leading to a faster release of the oils. So, the more the vesicles are damaged, the more accessible they are for carbon dioxide leading to a higher extraction yield. Scanning electron microscope images of ground coriander seeds before (Fig. 3A) and after (Fig. 3B) supercritical extraction show holes on the particle surface after extraction that are not present before extraction. In addition, reducing the size fraction of ground seeds from 0.5 mm (experiment 1 in Table 1) to 0.3 mm (experiment 4 in Table 1) slightly influences the extraction ratio which increases from 85% to 88%.

3.2.2. Influence of flow rate

To study the effect of solvent flow rate on extraction efficiency, three extraction tests were performed under the same operating conditions with three different flow rates of CO₂: 1 kg/h, 1.5 kg/h

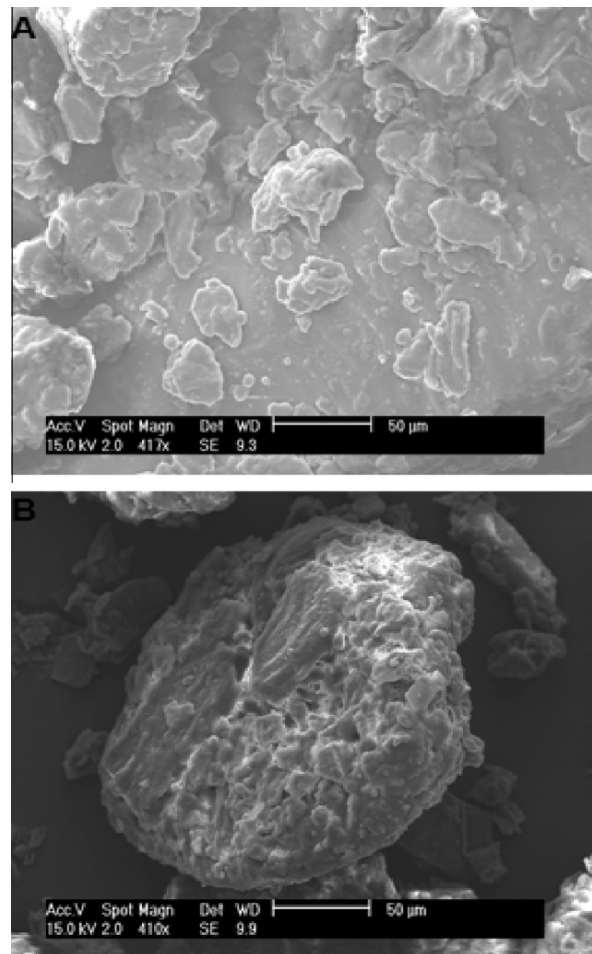

Fig. 3. Scanning electron microscope images of ground coriander seeds (d = 0.5 mm) (A) before supercritical extraction; (B) after supercritical extraction.

and 2 kg/h. (experiments 4, 7 and 8 in Table 1). Resulting kinetics of extraction are given in Fig. 4.

The results show that increasing the flow rate of CO₂ first accelerates the kinetics of extraction. Indeed, external mass transfer coefficient increases with the flow rate of CO₂ (Table 2). In addition, the driving force (difference between the oil concentration on the seed surface and in the CO₂ phase) for external transfer increases with CO₂ flowrate. Hence, time required to reach the plateau decreased from 160 min for 1 kg/h to 80 min for 2 kg/h. Second, the plateau level lowers and the resulting extraction yield decreases significantly from 88% to 61% when the flow of CO₂ increases to 2 kg/h. Considering the subfigure in Fig. 4 where the extract amount is presented in function of carbon dioxide use, all the curves initially fit on a straight line whose slope gives an overall solubility of the molecules extracted from coriander seeds. This solubility is then of 3.676 g/kg_{CO₂} at 21 MPa and 35 °C. These results are classical in extraction and similar to those obtained by Catchpole and Grey (1996). They may be explained by the reduction of the contacting time between the carbon dioxide and the bed of coriander during the extraction step. To confirm this result, we have calculated the residence time of carbon dioxide through the bed of coriander, given that the number of passages of CO₂ through the bed remains unchanged. This time decreases from 3.96 min to 1.98 min when the flow rate rises from 1 kg/h to 2 kg/h. As an additional explanation, it can be suggested that even if carbon dioxide flows faster at the contacting surface of the seeds, thus enhancing external mass transfer, the internal transfer of oils inside the particles is not influenced and becomes increasingly limiting, thus inducing a decrease of the oil concentration at the contacting surface of the seeds. The increase of the Biot number with the flow rate of CO₂ strengthens this suggestion (Table 2). Hence, 1 kg/h has been chosen for the following experiments.

3.2.3. Influence of pressure

The influence of two different pressures, 10 and 21 MPa, on the extraction ratio has been considered at 35 °C, for a mean particle size of ground seeds of 0.5 mm and a supercritical fluid flow rate of 1 kg/h. This corresponds to experiments 1 and 2 in Table 1 and extraction kinetic is given in Fig. 5.

Statistical analysis (Table 2) and the extraction curves (Fig. 5) show that the increase of pressure enhances the kinetics and greatly reduces the extraction time while increasing significantly the extraction efficiency. Indeed, as the pressure increases from 10 to 21 MPa, the extraction ratio rises from 23% to 85% and the time needed to achieve the extraction decreases from more than 300 min to 200 min. These effects could be attributed to the in-

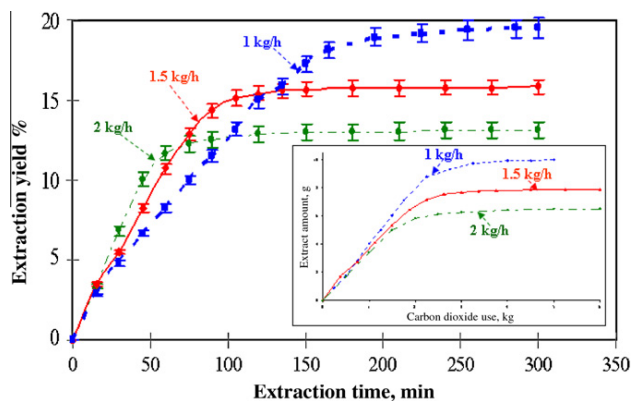

Fig. 4. Effect of the CO₂ flow rate on the extraction yield in function of time for P = 21 MPa, T = 35 °C and d = 0.3 mm.

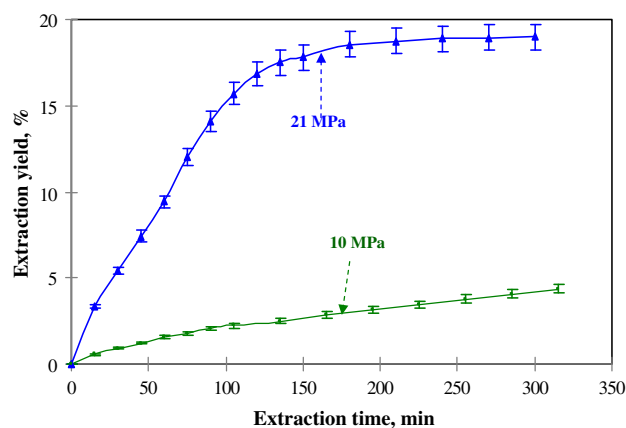

Fig. 5. Effect of pressure on the extraction yield in function of time for T = 35 °C, Q = 1 kg/h and d = 0.5 mm.

crease of the CO₂ density, related to the solvent power and then the solubility of the oil. Similar effect of pressure on extraction has been observed by several research teams who have worked on the extraction of oil seeds by supercritical CO₂ (Bandoni et al., 1998; Catchpole and Grey, 1996; Machmudah et al., 2008; Grosso et al., 2008; Illés et al., 2000; Temelli, 2009). In addition, to go further in the comprehension of the extraction kinetics, diffusivities of the solute transferred into the supercritical fluid have been calculated. We have found that values of diffusivities at a pressure of 10 MPa and 21 MPa were respectively $0.5 \times 10^{-13} \text{ m}^2/\text{s}$ and $10^{-13} \text{ m}^2/\text{s}$.

As for the oil composition, when the pressure increases from 10 MPa to 21 MPa, the amount of extracted EO remains the same while the amount of VO extracted increases significantly. Therefore, the extraction of EO can then be performed at a moderate pressure of 10 MPa while the VO extraction requires higher pressures. To confirm this, an extraction test in two steps has been performed in order to extract first the EO and second the VO at two different pressures (8 MPa and 21 MPa) and thus at two different CO₂ densities (Fig. 6):

First Step: 8 MPa and 35 °C, which corresponds to a CO₂ density of 419.9 kg/m³.

Second Step: 21 MPa and 35 °C, which corresponds to a CO₂ density of 873.6 kg/m³.

The CO₂ densities have been obtained from the equation of state proposed by Span and Wagner (1996).

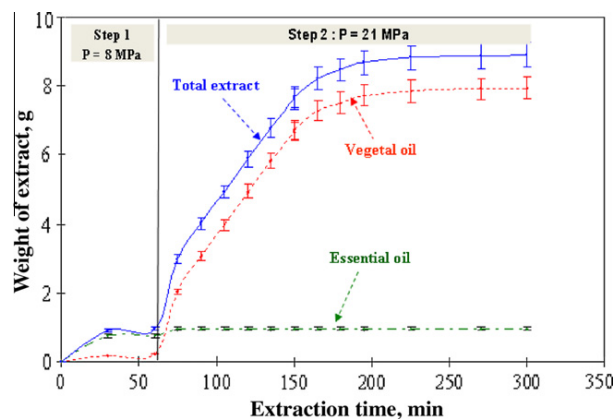

Fig. 6. Effect of pressure on the selectivity of the two-step extraction process.

Fig. 6 shows that during the first extraction step (8 MPa), only the EO and water were recovered while in the second step (21 MPa) only VO was recovered. These results confirm our previous comments about the effect of pressure and subsequent density of CO₂ on the selectivity of the extraction of both oils. As a conclusion, this two step extraction is then a selective process that is effective and rather easy to implement.

3.2.4. Influence of temperature

The influence of the extraction temperature (35 °C, 45 °C and 55 °C) has been studied using the following extraction conditions of pressure, flow rate, and particle size: 21 MPa, 1 kg/h and 0.3 mm. It corresponds to experiments 4, 5 and 6 in Table 1. The resulting extraction kinetic is presented in Fig. 7.

The temperature does not exert a significant effect on the extraction ratio. Indeed, it increases from 88% to 90% as temperature rises from 35 °C to 55 °C but this increase proved to be insignificant at the 5% error level. This limited effect of the temperature could be explained by two opposite phenomena that occur simultaneously. The increase of temperature induces a decrease of the CO₂ density and of its solvent power, tending to decrease the yield of extraction. In the same time, the rise in temperature induces an increase of the solute vapor pressure and therefore of its solubility in the supercritical fluid, tending to increase the extraction yield. These two opposite effects are competing. It has been often observed in previous works that the effect of vapor pressure prevails and the result is a positive effect of temperature on the extraction ratio (Brunner, 1994; Grosso et al., 2008). In this case, the balance of both effects appears without significant impact. In addition, temperature does not have significant effect on the extraction kinetics (Fig. 7). Therefore, on a process point of view, the temperature of 35 °C is a satisfying compromise.

3.2.5. Influence of density of CO₂

The combined effect of pressure and temperature resulting when changing solvent density is presented in Fig. 8. Five extraction tests were performed for five different values of CO₂ density and under the same conditions of CO₂ flow rate. They correspond to experiments 2, 4, 5, 6 and 10a in Table 1.

The results show that the extraction ratio drastically increases with density, which goes up from 2% for a density of 419 kg/m³ (when only EO is extracted) to 90% for a density value around 800 kg/m³. This significant effect of density on the extraction ratio confirms the prominent effect of the solvent power of CO₂ and hence of the solubility level of oils in carbon dioxide, which can

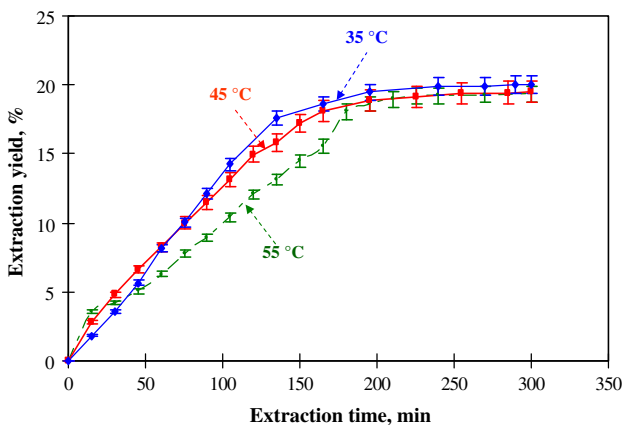

Fig. 7. Effect of temperature on the extraction yield versus time for $P = 21$ MPa, $Q = 1$ kg/h and $d = 0.3$ mm.

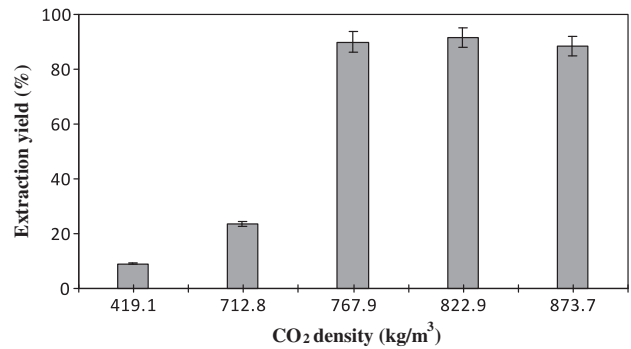

Fig. 8. Effect of the CO₂ density on the extraction ratio for $Q = 1$ kg/h.

be tuned mainly by varying pressure and, in a minor way, by changing temperature. In the same context, Temelli (2009) has shown that the solubility of triglycerides in carbon dioxide greatly increases when the CO₂ density rises for a constant value of temperature. For instance, at 50 °C, when the CO₂ density increases from 492 kg/m³ to 897 kg/m³, triolein solubility goes up from 6.7×10^{-3} g/L to 7.4 g/L.

3.3. Effect of the operating conditions on the composition of vegetal oil and essential oil

The VO and the EO obtained were analyzed and their chemical composition was compared with those obtained respectively by Soxhlet and steam distillation using the same particle size fraction (Tables 3 and 4).

3.3.1. Vegetal oil composition

Different samples of VO are analyzed by gas chromatography and their fatty acid composition is shown in Table 3.

VO of coriander is very rich in unsaturated fatty acids: about 95% in mass are unsaturated, splitted in 80% monounsaturated (mainly petroselinic acid, oleic acid palmitoleic acid and gadoleic acid) and 15% polyunsaturated (mainly linoleic acid and linolenic acid). The major fatty acid is petroselinic acid (above 70%). These values are similar to the results found by Msaada et al. (2009a,b). It is noteworthy that operating conditions (T, P, Q and d) have no major effect on the fatty acid composition of coriander VO (experiments 1–8 in Table 3). Comparing experiment 1 and 9 (Table 3) shows that, as can be expected, previous drying of the seeds at 70 °C has no influence on the fatty acid composition.

Comparison between the compositions of the VO obtained by organic solvent extraction (experiment Soxhlet in Table 3) and by supercritical CO₂ shows that both fatty acids profiles are similar. However, ten fatty acids have been identified from oil obtained by supercritical CO₂, while only nine have been identified from the oil extracted by Soxhlet. The latter does not contain arachidic acid but it is richer in gadoleic acid (0.39% compared to an average value of 0.11% in supercritical fluid extraction) and in oleic acid (6.69% compared to an average value of 5.77% in supercritical fluid extraction).

3.3.2. Essential oil composition

The composition of the coriander essential oil obtained by the supercritical extraction and the one obtained by steam distillation has been determined. The essential oil extracted from coriander seeds that were previously dried has also been analyzed (Table 4).

Results show that essential oil extracted by supercritical CO₂ contains 29 compounds, whereas 35 compounds have been identified in the case of extraction by steam distillation. This could be

Table 3

Fatty acid composition of different samples of vegetal oil.

Experiment										Soxhlet
Fatty acid (mass percent)	1	2	3	4	5	6	7	8	9	
<i>Saturated fatty acids (SFA)</i>										
Myristic acid (C14:0)	0.12	0.06	0.04	0.10	0.11	0.04	0.04	0.11	0.11	0.08
Palmitic acid (C16:0)	3.73	4.42	3.70	3.76	3.67	3.77	3.45	3.68	3.69	3.90
Stearic acid (C18:0)	1.29	0.97	0.94	1.15	1.03	0.94	0.96	1.14	0.95	0.97
Arachidic acid (C20:0)	0.16	0.18	0.16	0.14	0.14	0.16	0.15	0.14	0.13	0.00
Total SFA	5.29	5.64	4.83	5.15	4.95	4.90	4.59	5.08	4.88	4.95
<i>Monounsaturated fatty acids (MFA)</i>										
Palmitoleic acid (C16:1 Δ^9)	0.18	0.25	0.20	0.18	0.19	0.20	0.18	0.17	0.20	0.20
Petroselinic acid (C18:1 Δ^6)	73.9	72.3	73.7	74.7	75.0	73.7	75.3	74.7	74.2	72.99
Oleic acid (C18:1 Δ^9)	5.99	6.09	6.22	5.32	5.14	6.03	5.81	5.39	5.94	6.69
Gadoleic acid (C20:1 Δ^{11})	0.12	0.17	0.10	0.09	0.10	0.13	0.08	0.09	0.09	0.39
Total MFA	80.2	78.8	80.2	80.3	80.4	80.0	81.4	80.4	80.42	80.27
<i>Polyunsaturated fatty acids (PFA)</i>										
Linoleic acid (C18:2 $\Delta^{9,12}$)	14.3	15.3	14.6	14.3	14.4	14.7	13.7	14.3	14.5	14.60
Linolenic acid (C18:3 $\Delta^{9,12,15}$)	0.16	0.22	0.26	0.16	0.16	0.25	0.25	0.16	0.16	0.18
Total PFA	14.5	15.5	14.9	14.5	14.5	15.0	14.0	14.4	14.7	14.78
Total	100	100	100	100	100	100	100	100	100	100

attributed to hydrolysis and/or oxidation of some compounds during the extraction by steam distillation. For instance, linalool

Table 4

Chemical composition of coriander essential oil.

Experiment			
Component (mass percent)	Steam distillation extraction	Supercritical extraction (21 MPa, 35 °C, 1 kg/h and $d = 0.3$ mm)	Supercritical extraction from dried seeds ^a
α -Pinene	3.78	0.44	0.55
Camphene	0.44	0.10	
α -Thujene		0.37	
Myrcene	1.02	0.27	0.28
β -Pinene	0.02		
α -Terpinene	2.09	1.63	4.97
p-Cymene	2.64	0.63	0.95
Limonene	0.02	3.12	1.53
δ -Carene	0.03	2.39	
γ -Terpinene	9.88	2.77	0.98
Sabinene	0.06	0.34	0.17
1,8-Cineole	0.06	0.18	
Cis-linalool oxide (furanoid)	0.04		
Trans-linalool oxide (furanoid)	0.75		
Linalool	57.03	66.33	74.28
Camphor	5.13	3.34	3.96
Menthol	0.03	0.13	
Borneol	0.12	0.35	0.29
Terpinene-4-ol	0.34	0.95	0.22
α -Terpineol	0.52	0.33	
p-Cymene-8-ol	0.37	0.12	
Cis-dihydrocarvone	0.14	0.14	
Carvone	0.15	0.30	
Linalyl acetate	5.36	2.37	0.80
Nerol	0.06	0.12	0.20
β -Citronellol	0.24	0.58	
Geraniol	0.15	0.13	
Neral	0.06	0.06	
Thymol	0.04		
Anethole	0.05		
Geranial	0.03		
Carvacrol	0.03		
Eugenol	0.07	0.11	
Geranyl acetate	5.39	2.16	3.98
Caryphyllene	0.33	0.20	0.27
Humulene	0.05	0.45	0.81

^a This supercritical extraction experiment was performed at $P = 21$ MPa, $T = 35$ °C, $Q = 1$ kg/h and $d = 0.3$ mm, from seeds previously dried at 70 °C and 60 kPa for 24 h.

extracted by steam distillation exists in three forms, which are respectively linalool, cis linalool oxide and trans linalool oxide. In addition, essential oil extracted by supercritical CO₂ is richer in linalool and in limonene (66% and 3%) than that obtained by hydrodistillation (57% and 0.02%). At last, a previous drying of coriander seeds before extraction affects the quality of the essential oil. Indeed, only 16 compounds were identified. This could be explained by the evaporation of some of the volatile compounds, such as camphene, α thujene, 1,8 cineole, menthol, carvone..., during drying. This may also explain the lower extraction ratio obtained for experiment 9 when compared to experiment 1 (Table 2).

4. Conclusion

Coriander seeds were extracted using supercritical carbon dioxide to obtain selectively vegetal oil and essential oil. A process in four steps has been set up. A range of pressures, temperatures, particle diameters and carbon dioxide flow rates were investigated in order to elucidate their effect on the extraction yield and the composition of the extract. Pressure, particle size and flow rate have revealed to have a significant influence on the extraction yield while they have no major effect on the composition of the extracted oils. The vegetal oil obtained is rich in petroselinic acid and its fatty acid composition is similar to that obtained by Soxhlet. The essential oil extracted is undamaged compared to steam distillation extraction and supercritical extraction from dried coriander seeds.

As for the process proposed in this work, the selective extraction of vegetal and essential oils can be conducted according to two ways: either extracting selectively or fractionating oils after extraction. The first way consists in extracting both oils at the same time at a pressure of 21 MPa and in fractionating them afterwards using two consecutive separators with adequate temperature and pressure conditions. It has been found that 21 MPa and 35 °C as extraction conditions together with a supercritical fluid flow rate of 1 kg/h and a mean size of 0.5 mm for the ground seeds are the best conditions tested to extract oils of good quality and to maximize the extraction ratio (90%). This study has also shown that 7 MPa and 30 °C in separator 1 and 4 MPa and 10 °C in separator 2 allows recovering respectively the VO and EO. The second method is a new selective process in two consecutive extraction steps. The first extraction step is performed at 8 MPa and 35 °C in order to extract only the EO. Then, 21 MPa and 35 °C are the convenient extraction conditions for the second step which allows extracting VO.

Acknowledgments

This work is part of a research project financed with the help of the Région Midi Pyrénées, France, which is gratefully acknowledged. The CNRS (France) and the DGRS (Tunisia) contributed also to finance this work through their joint program of international cooperation. The authors also thank the team from LCA ENSIACET Toulouse, France and especially Mr. Thierry Talou for the chromatographic analyses.

References

- Aluko, R.E., McIntosh, T., Reaney, M., 2001. Comparative study of the emulsifying and foaming properties of defatted coriander (*Coriandrum sativum*) seed flour and protein concentrate. *Food Research International* 34 (8), 733–738.
- Anitescu, G., Doneanu, C., Radulescu, V., 1997. Isolation of coriander oil: comparison between steam distillation and supercritical CO₂ extraction. *Flavour and Fragrance Journal* 12 (3), 173–176.
- Bandoni, A.L., Mizrahi, I., Juarez, M.A., 1998. Composition and quality of the essential oil of coriander (*Coriandrum sativum* L.) from Argentina (average analysis of 6 oils). *Journal of Essential Oil Research* 10, 581–584.
- Boutin, O., Badens, E., 2009. Extraction from oleaginous seeds using supercritical CO₂: experimental design and products quality. *Journal of Food Engineering* 92 (4), 396–402.
- Brunner, G., 1994. Gaz extraction. In: Baumgartel, H., Frank, U. (Eds.), *Topics in Physical Chemistry*. Springer, New York, pp. 3–163.
- Brunner, G., 2005. Supercritical fluids: technology and application to food processing. *Journal of Food Engineering* 67 (1–2), 21–33.
- Burdok, G.A., Carabin, L.G., 2009. Safety assessment of coriander (*Coriandrum sativum* L.) essential oil as a good ingredient. *Food and Chemical Toxicology* 47 (1), 22–34.
- Catchpole, O.J., Grey, J.B., 1996. Near-critical extraction of sage, celery, and coriander seed. *Journal of Supercritical Fluids* 9 (4), 273–279.
- Chithra, V., Leelamma, S., 2000. *Coriandrum sativum* – effect on lipid metabolism in 1,2-dimethyl hydrazine induced colon cancer. *Journal of Ethnopharmacology* 71 (3), 457–463.
- Donelian, A., Carlson, L.H.C., Lopes, T.J., Machado, R.A.F., 2009. Comparison of extraction of patchouli (*Pogostemon cablin*) essential oil with supercritical CO₂ and by steam distillation. *Journal of Supercritical Fluids* 48 (1), 15–20.
- Eyres, G., Dufour, J.P., Halifax, G., Sotheeswaran, S., Marriott, P.J., 2005. Identification of character-impact odorants in coriander and wild coriander leaves using gas chromatography-olfactometry (GCO) and comprehensive two-dimensional gas chromatography-time-of-flight mass spectrometry (GOC × GC–TOFMS). *Journal of Separation Science* 28 (9–10), 1061–1074.
- Gallagher, A.M., Flatt, P.R., Duffy, G., Abdel-Wahab, Y.H.A., 2003. The effects of traditional antidiabetic plants on in vitro glucose diffusion. *Nutrition Research* 23 (3), 413–424.
- Goto, M., Sato, M., Hirose, T., 1993. Extraction of peppermint oil by supercritical carbon dioxide. *Journal of Chemical Engineering* 26 (4), 401–407.
- Goto, M., Hirose, T., McCoy, B.J., 1994. Continuous-mixture model of extraction processes. *Journal of Supercritical Fluids* 7 (1), 61–66.
- Grosso, C., Ferraro, V., Figueiredo, A.C., Barroso, J.G., Coelho, J.A., Palavra, A.M., 2008. Supercritical carbon dioxide extraction of volatile oil from Italian coriander seeds. *Food Chemistry* 111 (1), 197–203.
- Illés, V., Daood, H.G., Perneckzi, S., Szokonya, L., Then, M., 2000. Extraction of coriander seed oil by CO₂ and propane at super- and subcritical conditions. *Journal of Supercritical Fluids* 17 (2), 177–186.
- Jabeen, Q., Bashir, S., Lyoussi, B., Gilani, A.H., 2009. Coriander fruit exhibits gut modulatory, blood pressure lowering and diuretic activities. *Journal of Ethnopharmacology* 122 (1), 123–130.
- Kubo, I., Fujita, K., Kubo, A., Nihei, K., Ogura, T., 2004. Antibacterial activity of coriander volatile compounds against *Salmonella choleraesuis*. *Journal of Agricultural and Food Chemistry* 52 (11), 3329–3332.
- Machmudah, S., Kondo, M., Sasaki, M., Goto, M., Munemasa, J., Yamagata, M., 2008. Pressure effect in supercritical CO₂ extraction of plant seeds. *Journal of Supercritical Fluids* 44, 301–307.
- Matasyoh, J.C., Maiyo, Z.C., Ngure, R.M., Chepkorir, R., 2009. Chemical composition and antimicrobial activity of the essential oil of *Coriandrum sativum*. *Food Chemistry* 113 (2), 526–529.
- Mohamed, R.S., Mansoori, G.A., 2002. The use of supercritical fluid extraction technology in food processing. *Food Technology Magazine* 20, 134–139.
- Msaada, K., Hosni, K., Ben Taarit, M., Chahed, T., Kchouk, M.E., Marzouk, B., 2007. Changes on essential oil composition of coriander (*Coriandrum sativum* L.) fruits during three stages of maturity. *Food Chemistry* 102 (4), 1131–1134.
- Msaada, K., Hosni, K., Ben Taarit, M., Chahed, T., Hammami, M., Marzouk, B., 2009a. Changes in fatty acid composition of coriander (*Coriandrum sativum* L.) fruit during maturation. *Industrial Crops and Products* 29 (2–3), 269–274.
- Msaada, K., Hosni, K., Ben Taarit, M., Chahed, T., Hammami, M., Marzouk, B., 2009b. Effects of growing region and maturity stages on oil yield and fatty acid composition of coriander (*Coriandrum sativum* L.) fruit. *Scientia Horticulturae* 120 (4), 525–531.
- Perrut, M., Clavier, J.Y., 2003. Supercritical fluid formulation: process choice and scale-up. *Industrial and Engineering Chemistry Research* 42 (25), 6375–6383.
- Span, R., Wagner, W., 1996. A new equation of state for carbon dioxide covering the fluid region from the triple-point temperature to 1100 K at pressures up to 800 MPa. *Journal of Physical and Chemical Reference Data* 25 (6), 1509–1596.
- Temelli, F., 2009. Perspectives on supercritical fluid processing of fats and oils. *The Journal of Supercritical Fluids* 47 (3), 583–590.
- Wangensteen, H., Samuelsen, A.B., Malterud, K.E., 2004. Antioxidant activity in extracts from coriander. *Food Chemistry* 88 (2), 293–297.