



HAL
open science

A new fuzzy logic based node localization mechanism for Wireless Sensor Networks

Saber Amri, Fekher Khelifi, Abbas Bradai, Abderrezak Rachedi, Med Lassaad
Kaddachi, Mohamed Atri

► To cite this version:

Saber Amri, Fekher Khelifi, Abbas Bradai, Abderrezak Rachedi, Med Lassaad Kaddachi, et al.. A new fuzzy logic based node localization mechanism for Wireless Sensor Networks. *Future Generation Computer Systems*, 2019, 113, pp.170-182. 10.1016/j.future.2017.10.023 . hal-01617438

HAL Id: hal-01617438

<https://hal.science/hal-01617438>

Submitted on 21 Oct 2021

HAL is a multi-disciplinary open access archive for the deposit and dissemination of scientific research documents, whether they are published or not. The documents may come from teaching and research institutions in France or abroad, or from public or private research centers.

L'archive ouverte pluridisciplinaire **HAL**, est destinée au dépôt et à la diffusion de documents scientifiques de niveau recherche, publiés ou non, émanant des établissements d'enseignement et de recherche français ou étrangers, des laboratoires publics ou privés.



Distributed under a Creative Commons Attribution - NonCommercial 4.0 International License

A new fuzzy logic based node localization mechanism for Wireless Sensor Networks

Saber AMRI^a, Fekher KHELIFI^{b,c}, Abbas BRADAI^c, Abderrezak Rachedi^d, Med Lassaad KADDACHI^b and Mohamed Atri^b

^aResearch Groups in Intelligent Machines, University of Sfax, National School of Engineers (ENIS), BP 1173, Sfax, 3038, Tunisia.

^bLaboratory of Electronics and Microelectronics (E μ E), Faculty of Sciences, University of Monastir (UM), Monastir 5019, Tunisia

^cXLIM Institute, University of Poitiers, Poitiers 86130, France

^dUniversité Paris-Est, LIGM (UMR8049), UPEM F-77454, Marne-la-Vallée, France

Fakher.Khelifi@fsm.rnu.tn, saber.amri.tn@ieee.org, abbas.bradai@univ-poitiers.fr and lassaad.kaddachi@gmail.com

Abstract: Being aware of the nodes positions is a key issue in order to locate precisely the sensor node, localization is very important information about sensor nodes in wireless sensor network (WSNs). Hence, the precision improvement is a significant issue that allows an effective data transmission between sensor network (SN) in order to save their energy and extend the network lifetime. In this work, we propose and implement a new mechanism for geographic routing. Therefore, the proposed mechanism is relied on a weighted centroid localization technique, where the positions of unknown nodes are calculated using fuzzy logic method. For this, we propose a fuzzy localization algorithm that uses flow measurement through wireless channel to compute the distance separating the anchor and the sensor nodes. Subsequently, our work is based on the centroid algorithm that calculates the position of unknown nodes using fuzzy Mamdani and Sugeno inference system for increasing the accuracy of estimated positions. Once the localization algorithm has detected the location of nodes with unknown position, the proposed mechanism selects effectively the next-elected CH to reduce the energy dissipation of sensor nodes, which leads to an extension of the network lifetime. The main advantages of the proposed mechanism are three folds: the first is to minimize the position error of nodes and reduces the error localization average. The second is to increase the number of packets transmitted to the next hop cluster head (CH) based on the localization algorithm. The third one is to, reduce the energy consumption of nodes and then extends the network lifetime using an efficient selection of next hop CH. The obtained simulation results show that the proposed mechanism outperforms the existing solutions in terms of energy consumption, execution time (localization time) and localization error, similarly for the number of the packets transmitted to the base station.

Keywords: WSN, IoT, Localization, Transmission, Fuzzy Logic, RSSI.

1. Introduction

The emergence of Internet of Things (IoT) is revolutionizing the way people live. Many daily applications based on IoT [1], [2], [3], [39][40][41] require nodes position, and then nodes localization. For instance, geographic routing process in data transportation is a data centric approach where nodes positions are necessary. In this work, we focus on nodes localization in IoT particularly on Wireless Sensor Networks (WSNs). WSN is known as part of IoT and it is defined as a collection of sensor devices distributed randomly to collect data from different areas [1], [2], [3]. In recent years, WSN are used in many fields such as medical care, smart systems, environmental and military surveillance and nodes tracking [4][35]. However, the limited capability of nodes in terms of treating and computing makes necessary the preservation of energy for increasing the network lifetime. Accordingly, minimizing the energy consumption is a fundamental way to optimize the data transmission process [2], [3], [5].

1.1 Motivation

Being aware of the nodes positions is a key issue in order to locate precisely the SN [6]. In fact, both “range-based” and “range-free” localization algorithms are interested in solving several requirements related to the accuracy and the low cost criteria [7]. The Localization techniques Range-Based are based on measuring of the distance or the angle between the directions of reference nodes called anchors. Several technologies allow as well as the measure of these nodes like the RSSI (Received Signal Strength Indicator) [9], the TOA (Time of Arrival) [8], the TDOA (Time Difference of Arrival) [10] and the AOA (Angle of Arrival) [11]. Unlike, nodes positions can be calculated using trilateration or range-based localization triangulation [7]. The comparative study of RSSI-based localization algorithms using spatial diversity in WSNs is proposed in [36]. They seem inappropriate; In fact, the first solution is based on the consumed energy by the measuring equipments and increasing inappropriate cost as well. The second solution is clearly linked to the measurement accuracy, which is based on multiple parameters as humidity, noise and propagation. The range-free localization can greatly avoid these two drawbacks. While the typical nodes whether fixed or mobile with a well determined position are called anchors, other with unknown position are normal nodes. They calculate, indeed, their positions using the connectivity information and the positions of anchors nodes. Range-free technology is more profitable thanks to the independence of the hardware devices and the distance computing [7]. Hence, this

independence allows the adaption technology of different wireless transmission types. In the literature, there are many technical “range-free” locations as centroid [12] and CPE (Convex Position Estimate) [13] which require regular nodes and have at least three adjacent anchors for the next hop. Although these algorithms provide more economic and simple estimations, their results are not as accurate as tracking error level. A precise detection of the transmitter node position allows an effective routing of information with a minimum energy consumption. Another important parameter is the localization time which is the necessary time for the network localization. In [37] authors study the time bounded localization for WSN using Multidimensional Scaling (MDS).

The main geographic routing protocols are based on classical routing protocol. In WSN can be classified as hierarchical and flat protocols [14]. In a multi-hop hierarchical communication, the individual clusters formed the Cluster-based approach [5][38], and each member node interacts with its cluster head that aggregates data then transfer them into multiple paths to adjacent CHs, which transmit the data until the Base Station (BS). Referring to different studies of communication energy model [14], hierarchical routing protocols are more adaptable for conserving energy than those of the plane routing .In addition, the authors in [15] and [16] mentioned that the use of multi-hop routing protocols allows a clear minimizing of energy compared to the single hop routing protocols. In a single hop plane routing protocol, sensor nodes send directly their data to the BS, whereas in a multi-hop transmission, nodes communicate among themselves before any connection with the Base Station.

TABLE I. Motivation

Options	Advantages	Disadvantages
Range-based localization algorithms [8][9][10]	Nodes decide their position taking into account angle or distance calculation from some anchor nodes with well-known positions.	More costly than range-free” localization algorithms
Range-free localization algorithms [7]	Localization is independent of the hardware devices and the distance computing	Results are not as accurate as tracking error level
Hierarchical routing protocols [15][16]	More adaptable for conserving energy, convenient topology management, high-efficiency energy use, and simple data fusion	Implementation complexity, database management problem, lack of structural Independence, implementation limitation
Flat routing protocols [14]	No effort is made to organize the network or its traffic, discovering the best route hop	The network IDs have no subnet structure and cannot be summarized

	by hop by any path.	
Multi-hop routing protocols [14]	Allows a clear minimizing of energy based on the local topology information, use of multi-hop communication mode, no complicated calculation in routing phase, routing mechanism is simple and efficient	Less energy efficient, less end-to-end delay, higher packet loss, the node can not store large amounts of routing information
Single hop plane routing protocols [14]	Much more energy efficient than multi-hop routing [3] Best network parameters such as end-to-end delay, lower packet loss	Complicated calculation in routing mechanism Inefficient routing mechanism

Localization using GPS coordinates is not applicable to be energy efficient or energy aware. In the case of sensor networks, energy is a uncommon resource and the sensor nodes may be deployed without any type of battery being changed for many years. For this, GPS devices are not convenient as valid solution of localization problem in WSN for many reasons:

- Once the expensive GPS devices are added to every sensor node in the network, this solution became unfeasible due to the increase of the deployment cost.
- With the inclusion of GPS device, the sensor nodes size become quite large which is contradictory with the required properties of WSN that nodes should be with small size.
- To be in function, GPS devices depend forever to satellites. In cases of failure with satellite link, GPS ceases to be in function. It's the case of many real applications as indoor and explorative applications. Finally, GPS in WSN stays depend of many factors as power consumption, cost, size, what is not the case of other localization techniques.

Most applications of WSN require that the sensor nodes must be aware of their location relative to the SN. For this, one of the important challenges in WSN is the localization of sensor nodes and determination of nodes positions in the sensor field. This is fundamental for many reasons. Firstly, collected data by sensor nodes such as, humidity, pressure and temperature must be accompanied with the location from where it was detected and collected. It would be useless if their location is unknown. Second, the efficient utilization of energy resource is one of the biggest challenges in WSN. In this contexte, data transmission operation is one of the most energy dependent phase which must use energy-efficient and

energy-aware routing algorithm. Due to multiple constraints, existing localization approaches, such as GPS, cannot be performants for the localization of sensor nodes. Therefore, new methods and algorithms for the sensor nodes localization are needed to be designed and implemented.

1.2. Contribution

As the localization is a very important factor for the sensor nodes, improving its precision is an essential issue that allows an effective data transmission between SNs of WSNs in order to conserve the energy consumption and extend the network lifetime. In this context, we have implemented a new mechanism for routing information based on nodes location. This designed mechanism is relied on a weighted centroid localization technique. Our main contributions in this paper are summarized as follows:

1. The locations of unknown nodes of SNs are calculated using fuzzy logic inference depending on RSSI values between the nodes. We put up, therefore, a fuzzy location algorithm that uses the measurement of the flow through a wireless channel to determine the distance separating the anchor nodes and the sensor ones. The centroid algorithm is used to figure out the location of unknown nodes using fuzzy Mamdani and Sugeno inference systems in order to increase the accuracy of the estimated position.
2. In order to reduce the energy consumption and to extend the network life, we introduce a new strategy to select the next-hop CH based on unknown-position nodes location detected by the localization algorithm that is key goal of the data transmission phase in our mechanism.
3. The proposed solution is after all based on four parameters: the energy level of current CH at a given time, the distance between the current CH and the next elected CH, the distance between the next elected CH and BS, and the density of the next elected CH. The choice of these two distances (which already present a contribution) is to avoid useless computing of distances between all the nodes of sensor network. We do not calculate the distances only after ensure a sufficient amount of energy and a low density of next elected CH. Concerning the next elected CH selection, each current CH node applies Mamdani Fuzzy Inference System [8] to join the hop having a minimum cost value to send data.

1.3. Paper organization

The paper is organized as following: section 2 introduces the location and the transmission algorithms in literature. In section 3, we present our contribution describing suggested mechanism in which we highlight how the fuzzy set theory can be applied for localizing the nodes positions. Then, we select the next hop with a minimum cost value for sending data using fuzzy logic method. Simulation results are, subsequently, described in Section 4. The last section presents the obtained results and future work.

2. Related work

2.1. Sensor node localization

Yun et al. [19] implemented, in fact, two intelligent algorithms for the localization in WSN to distinguish a range-free localization approach based on a received signal strength. In the first algorithm, a fuzzy logic system (FLS) is used to localize nodes through a combined sum of the edge weight of each anchor node. Then, the optimal edge weight is determined using a genetic algorithm (GA). The second algorithm uses actually a neural network (NN) technique where the input is the received signal strength and the output is the approximate location of wireless nodes. Simulation results using NN are in clear contradiction using FLS and GA. In fact, only four anchor nodes are applied to be located by FLS and GA in the experimentation. Four-neighboring anchor nodes are accurately used for the localization by NN.

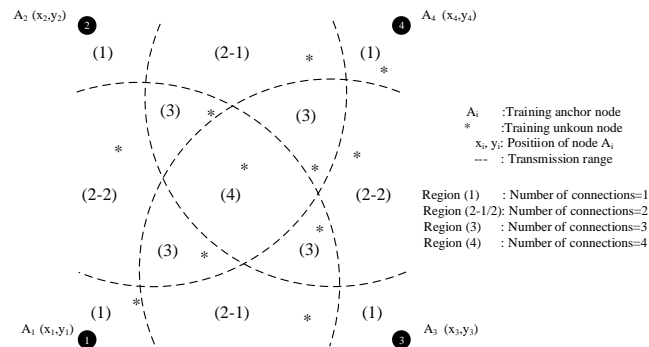

Figure 1. Network architecture of weighted centroid localization technique [19]

In [20], the authors proposed a “range-free” localization protocol for WSNs using weighted centroid localization technique. A selection of edge weights of SN is defined by the application of FL inference for RSSI and link quality. Hence, Mamdani, Sugeno, and Combined Mamdani Sugeno fuzzy logic inference are implemented in the fuzzy phase. This protocol is better than the conventional centroid in terms of localization accuracy. Thus, the proposed work has been compared to the centroid localization technique and to the Mamdani

and Sugeno fuzzy logic inference localization with two simulation scenarios. As a result, the deployment of nodes in the first scenario is in AWGN (Additive White Gaussian Noise) environment because the sensor nodes are deployed in AWGN environments with an external RF interference noise sources in the second scenario. RSSI and LQI (Link Quality Indicator) results are highly correlated with the WCL (weighted centroid localization) edge weights and the node distance in the presence of external RF interference. Consequently, this protocol becomes a compatible localization choice for sensor nodes that operates effectively with the presence of various external RF sources having the same frequency band.

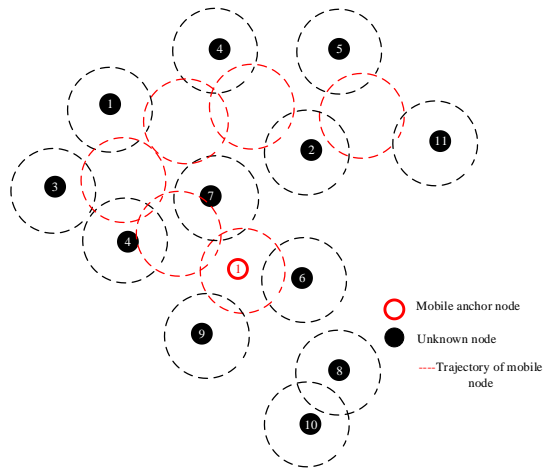

Figure 2. Network architecture of cooperative localization algorithm [20]

Chen et al. [21] implemented a cooperative localization algorithm. They use actually a mobile anchor node where the mobile anchors cooperate with the static anchors in order to improve the localization performance and the coverage using a handled in convex position of an estimated Algorithm. The effectiveness of this algorithm is average thanks to radio irregularity effects and obstacles. This localization scheme achieves highly the localization accuracy with the presence of obstacles. A convex localization algorithm has been implemented to solve the problems of non-ideal radio signals transmission. Hence, an optimal movement schedule for mobile nodes is applied to attain the shortest path within the localization accuracy. The achieved results show that the proposed localization algorithm can realize higher localization accuracy with a mobile node.

2.2. Data transmission

In [31], Authors proposed a smart Multi-hop hierarchical routing protocol for the Efficient Video communication for WMSN (wireless Multimedia Sensor Network) called MEVI. This protocol selects the links based on network conditions and energy issues and executes an intelligent routing algorithm to transmit multi-media data. It tries additionally to save energy

consumption during the transmission phase using a cluster approach with a low overhead, a multi-hop communication with a cross-layer mechanism and operational modes to transmit multimedia according to environmental information. Precisely, the nodes are divided into two types. While the first are, scalar sensor nodes provided with an energy supply restriction, wide capacities of processing and memorizing. The second types are camera nodes equipped with enough energy sources and a video camera with huge capabilities of memorizing and processing. In fact, MEVI ensures a multi-hop communication between CHs and BS relying on network conditions, energy and hops count with accordance of the physical environmental conditions to minimize the overall communication overhead. It extends as well as the network lifetime, and maximizes the scalability system and reliability, [31].

In [23], the authors enhanced an offline algorithm then an on-line adaptive mechanism integrated in an energy-efficient schedule for a transmission packet over a multi-hop communication path using modulation scaling [23]. They aim to conserve energy dissipation with a specific latency constraint satisfaction. Consequently, the simulation results improve the energy consumption, which can be, reduced clearly using an off-line algorithm. Moreover, two scenarios are implemented to improve the adaption of modulation settings respecting the variations system and the latency constraint. The obtained results prove that an important amount of consumed energy is decreased during the transmission without transgressing the latency constraint. In addition, the on-line algorithm is apparently able to adapt the modulation levels with a the system variation.

2.3 Routing protocol

An Improved Fuzzy Unequal Clustering scheme for large-scale wireless sensor networks is introduced in [24]. The authors try, therefore, to balance the energy consumption and extend the network lifetime focusing on an energy efficient clustering approach and inter-cluster routing protocol. They use a fuzzy logic system with the energy level, the distance to BS and the local density as inputs to select the next cluster head node. Then, they use an Ant Colony Optimization (ACO) approach for routing data between CHs and BS. This approach allows a reduction of cluster heads energy consumption and resolves effectively hot spot problem that persists in a multi-hop WSN routing protocol. Indeed, Sensor nodes produce data in form packets for CHs, which transmit data packets to BS after their collection and aggregation. Energy consumption of each node and error-free communication links are calculated per round. This algorithm is compared to several protocols as LEACH and EMHR

LEACH is a popular routing protocol for WSN and which is considered as the most vital protocol. It is additionally proposed to prolong the overall lifetime of the network and to

decrease the overall energy consumed by the network [33]. In fact, the operation in LEACH is divided into rounds. Hence, each round contains a set-up stage, where every sensor node picks a random number between 0 and 1 so as to decide whether it is a cluster-head or not. If the chosen number by a particular node is less than a threshold value $T(n)$, the node itself becomes a CH for the current round. Certainly, the LEACH protocol is able to keep the energy consumption of nodes and increases the lifetime of the network. However, it must be done under certain assumptions. It is supposed that all nodes can be transmitted with sufficient power to attain the base station. As the nodes always have the same data to transmit, they start with the same amount of energy and take away approximately the same amount of the CHs energy of each cluster member as well. In [34], the LEACH-FL (Improving on LEACH Protocol of Wireless Sensor Networks Using Fuzzy Logic) protocol is proposed. This protocol uses Fuzzy Logic to improve the LEACH protocol relying on three different parameters as the energy level, the node density, and the distance between the CH and the BS. This model, indeed, uses a set-up stage and a steady-state stage. In the set-up stage, It chooses different parameters to apply in the designed FIS in order to obtain the probability value for each node. Energy-Efficient Multi-Hop Protocol (EMHR) is a hierarchical routing protocol with a multi-hop communication. Based on energy efficiency, this algorithm optimizes the clustering process using as well as an energy strategy that avoids effectively low-energy nodes with to be cluster heads [32]. Furthermore, using the energy strategy in the cluster head decision, the node of the largest surplus energy is selected to become the cluster head, which can effectively avoid the low-energy nodes as the cluster head. Concerning data transmission, the data in cluster-heads can be simply transmitted through a multi-hop according to the determined of weight function setting up the next-hop cluster head. This EMHR protocol balances the load of network topology and reduces the cluster heads energy dissipation. As far as the transmission of information between sensor nodes is concerned, every cluster head and its next-hop cluster head find the optimization of the next-hop cluster head to ensure the minimum energy dissipation of data transmission to Sink node. By the way, a continuous selection next-hop cluster head is based on weight function, the data are transferred to the next-hop cluster head and subsequently, the last cluster head sends all data to sink node. In the first round of networks, the process of clustering is the same as the LEACH only if the threshold node is $i > T(n)$, the node i becomes the cluster head. In the next 'round' of networks which is based on the energy strategy of electing cluster head compared to the state of cluster members energy finds the largest energy node i . Correspondingly, the energy dissipation model adopts wireless channel models in the reference [14]. The Author of EMHR

protocol [32] assumes that the distance between the node cluster-head \mathbf{i} and the adjacent cluster head \mathbf{j} is $\mathbf{d(i,j)}$, the distance between the adjacent cluster head \mathbf{j} and the Sink node is $\mathbf{d(j,S)}$. The weighting function is set up as seen in the following equation (1).

$$F(\mathbf{i}, \mathbf{j}) = \left[\frac{\mathbf{S(i).E}}{\mathbf{S(i).max}} \right] + \left[\frac{\left[\mathbf{d(i,j)^2 + d(j,S)^2} \right]}{\mathbf{d(i,S)^2}} \right] \quad (1)$$

Where: $\mathbf{S(i).E}$ is the remaining energy of the cluster head \mathbf{i} and $\mathbf{S(i).max}$ is the initial energy of the cluster-head \mathbf{i} . Thereby, it means a continuous selection of the next-hop cluster-head based on this weighting function and the data is transmitted along the next-hop cluster-head. Once the minimum value of this function is selected for the next hop, the last cluster-head sends all data to the sink node.

Considering only the distance between the CH and its next-hop cluster head by the weight function and even the residual energy of the cluster-head transmitter, this ignores other factors that affect the energy consumption and the network lifetime. In fact, some other cases where the next-hop cluster head is depleted of energy or when it is overloaded, the sent data will be certainly lost. Actually, it seems a disadvantage. It is not always a guarantee to transmit data to the BS simply because the selection of the next Cluster-Head depends only on the distance separating it and the CH transmitter and its residual energy. Integrating the Artificial Intelligence (AI) in WSN challenges is to solve different problems in this field [2], which has made a fuzzy logic. Subsequently, it is one of the most important paradigms used for real-time decisions in WSN relying on the output results of the fuzzy inference system [4]. Numerous studies, thereafter, presented these protocols using FL [25] [26] [27] for the CH election and the cluster formation. Within this context, our method actually solves these problems just as it executes an intelligent localization algorithm of nodes relying on an intelligent fuzzy logic technique for next-hop CH selection. As a consequence, the results of the experience show that the proposed clustering scheme is performing better than the previously mentioned protocols.

3. Proposed mechanism for node localization

The proposed mechanism for routing information based on the nodes localization is centered on weighted centroid localization technique. It is merely by computing the locations of the unknown nodes of SNs using fuzzy logic inference based on RSSI values between nodes. In addition, the proposed algorithm depends on the measurement of the flow through wireless channel to determine the distance between the anchor and the sensor nodes. Routing data phase in our mechanism is used mainly to optimize the next-hop CH selection based on

the location of nodes with unknown position, which has been already specified by the intelligent localization algorithm. Moreover, an efficient transmission of data allows to reduce energy dissipation of sensor nodes and thus to extend the network lifetime which is the main objective of WSN field.

3.1 Phase1: Fuzzy localization algorithm

Firstly, we propose a fuzzy localization algorithm based on a Range-free technique for WSN. It is based on RSSI values to estimate unknown nodes positions. This technique does not require additional hardware since most radios can get the RSSI value directly. Hence, this approach consists of two main phases. First, the anchors diffuse their neighbor normal nodes and then receive the transmitted beacons from links and measure the value of RSSI. Thus it calculates the distance bitter calculated by each node using a fuzzy system to estimates its position based on this value. Each measuring distance and processes is used to obtain the value. If a node receives an RSSI with a higher value, the anchor is probably close to and must have a higher weight as well. For this reason, we consider the following rules:

Mamdani's fuzzy model

Mamdani's work was based on Zadeh's 1973 publication on fuzzy algorithms for complex systems and decision processes [55]. This method consists of: (1) combining the fuzzified inputs according to the fuzzy rules in order to establish rule strength, (2) finding the consequence of the rule by combining the rule strength and the output membership function, and (3) combining the consequences to generate an output distribution.

The implication method (Mamdani's method) is:

$$\mu' \text{ conclusion } (y) = \text{MIN } \mu \text{ premise } (x0), \mu \text{ conclusion } (y)) \quad (1)$$

It integrates the most commonly defuzzification method, which is the centroid technique. It allows finding a point representing the Center of gravity (COG) of the output fuzzy set. It is the abscissa of the center of gravity of the area under the curve results:

$$\text{Output} = \int y \cdot \mu(y) \cdot dy / \int \mu(y) \cdot dy$$

With \int is the universe of discourse (all the considered output values)

Sugeno fuzzy model

A typical rule in a Sugeno fuzzy model [56] has the form:

If Input 1 is x and Input 2 is y , then Output is $z = ax + by + c$

For a zero-order Sugeno model, the output level z is a constant ($a = b = 0$).

Each rule weights its output level, z_i , by the firing strength of the rule, w_i . For example, for an AND rule with Input 1 = x and Input 2 = y , the firing strength is

$$w_i = \text{AndMethod}(F_1(x), F_2(y))$$

Where $F_{1,2}(\cdot)$ are the membership functions for Inputs 1 and 2.

The final output of the system is the weighted average of all rule outputs, computed as

$$\text{Final Output} = \frac{\sum_{i=1}^N W_i Z_i}{\sum_{i=1}^N W_i}$$

Where N is the number of rules. A Sugeno rule operates as shown in the following diagram.

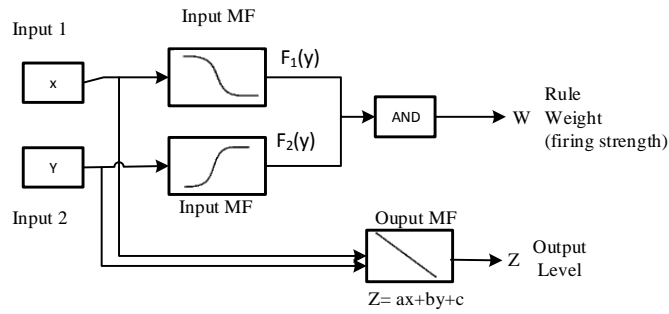

Figure 3. Sugeno diagram

TABLE.II: FUZZY RULE BASE FOR LOCALIZATION ALGORITHM

<i>Rule</i>	<i>Antecedent</i>	<i>Consequent</i>
Rule 1:	IF: RSSI is very low THEN:	Weight is very low
Rule 2:	IF: RSSI is low THEN:	Weight is very low
Rule 3:	IF: RSSI is medium THEN:	Weight is medium
Rule 4:	IF: RSSI is high THEN:	Weight is high
Rule 5:	IF: RSSI is very high THEN:	Weight is very high

In this new localization method, a fuzzy inference system, an input RSSI value and an output weight value were modeled with the Mamdani and Sugeno methods. While the RSSI can take a value between $[0, \text{RSSI}_{\max}]$, the RSSI_{\max} itself is the maximum value of RSSI. The

RSSI space is divided into five trapezoidal functions (very_low, low, medium, high and very_high) as shown in figure4.

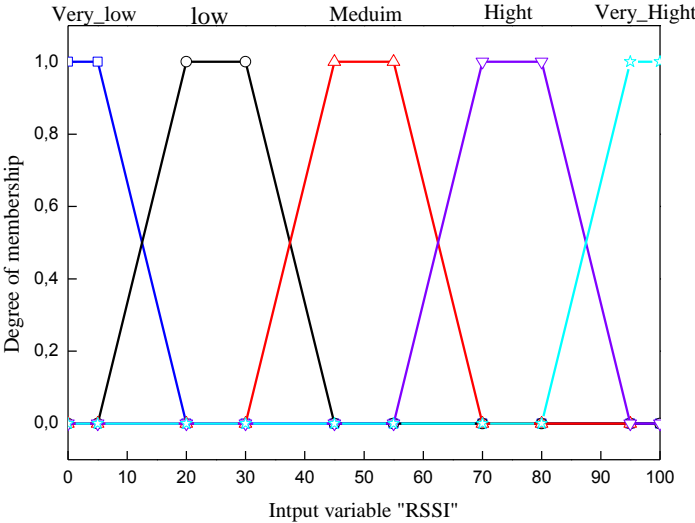

Figure 4.Fuzzy membership function of RSSI

The variable output is the curb weight of each anchor node, and may take a value between 0 and W_{max} , where W_{max} is the maximum value of weight. The weight space is divided into five trapezoid functions (very_low, low, medium, high and very_high) as shown in the figure 5.

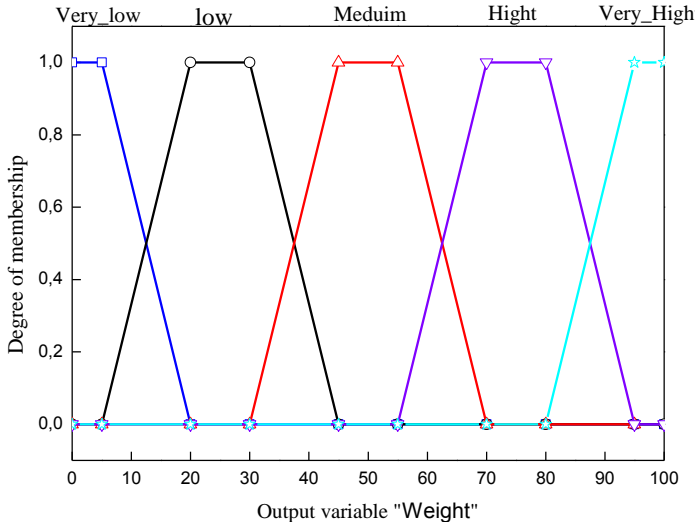

Figure 5.Fuzzy membership function of Weight

The main difference between Sugeno and Mamdani methods is that the output membership functions are either linear or constant. After calculating the edge weights using Sugeno and

Mamdani fuzzy inference system, the weighted centroid algorithm is used to estimate the sensor node position based on the position of the adjacent connected anchor nodes (X_1, Y_1) , $(X_2, Y_2) \dots (X_n, Y_n)$ respectively. Figure 6 shows an example with three nodes.

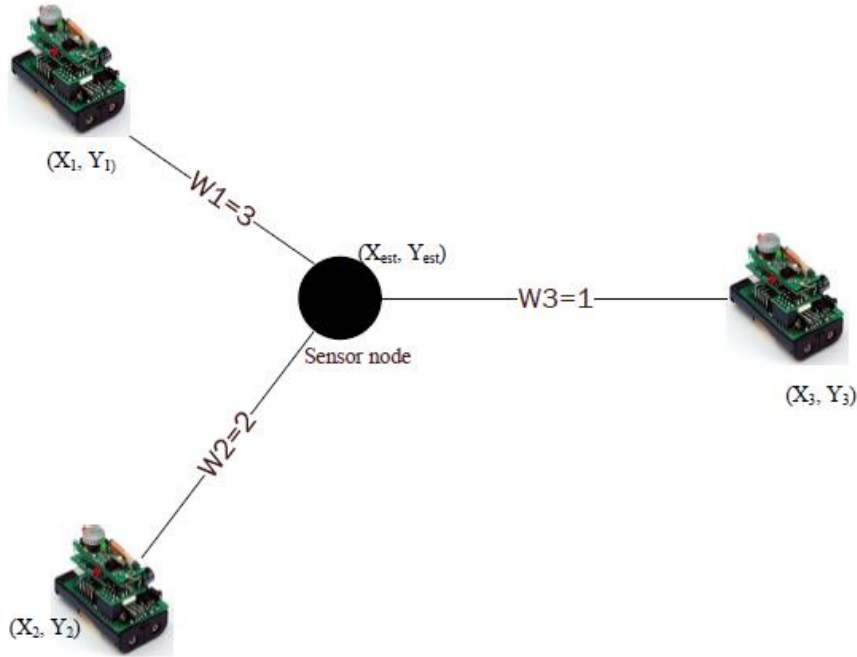

Figure 6. Simple example of weighted centroid method

The unknown node calculates its position as the following weighted centroid formula:

$$(X_{est}, Y_{est}) = \left(\frac{X_1 W_1 + X_2 W_2 + X_3 W_3}{W_1 + W_2 + W_3}, \frac{Y_1 W_1 + Y_2 W_2 + Y_3 W_3}{W_1 + W_2 + W_3} \right) \quad (2)$$

Where w_i is the edge weight of anchor node linked to sensor node, two performance indices have used the distance between the estimated and the actual position of sensor node.

$$\text{Localization Error} = \sqrt{(X_{est} - X_a)^2 + (Y_{est} - Y_a)^2} \quad (3)$$

Where (X_{est}, Y_{est}) is estimated as the position of sensor node and (X_a, Y_a) is its actual position. The average distance between the estimated and the actual position of all sensor nodes is calculated as the following:

$$\text{Average Localization Error} = \frac{\sum \sqrt{(X_{est} - X_a)^2 + (Y_{est} - Y_a)^2}}{\text{number of sensor nodes}} \quad (4).$$

3.2. Phase 2: Localization algorithm

This section describes the fuzzy logic algorithm for SN localizations; In such ways, the output weight will be derived to adjust the weight as follows: First, a set of interesting node parameters will be considered. Afterwards, the membership function of the input RSSI and output weight will be generated. Next, the fuzzy inference

engine will be applied using the aggregation method. Once the output is generated, the output weight is calculated based on CoG method. Finally, the location estimation is calculated based on Equation (2), then the distance (CH_i,CH_j) and distance(CH_j, BS) were determined. Finally, Location Error and Average Location Error were calculated based on respectively equation 3 and 4.

Fuzzy Logic for WSN Localizations (FL)

Function Distance(CH,CH)

Input: RSSI,

Output: Weight

1. Select Population of Interest Nodes
2. Generate Membership Function for Input RSSI
3. Generate Membership Function for Output weight
4. Generate Fuzzy Rule (RSSI, weight)
5. Apply Fuzzy Inference Engine with Aggregation (RSSI, weight)
6. Calculate Output Weight (w) from CoG
7. Calculate Location Estimation based on Equation 2
8. Calculate Distance (CH_i,CH_j) and Distance(CH_j, BS)
9. Calculate Location Error based on Equation 3
9. Calculate Average Location Error based on Equation 4

3.3. Phase 3: Data Transmission

Once the localization algorithm has detected the location of nodes with unknown position, a key goal of the data transmission phase in our mechanism becomes an effective selection of the next-hop CH to reduce energy dissipation of sensor nodes. Thereafter, an extension of the network lifetime is our primary objective.

For this reason, Electing cluster head strategy depends on electing the largest surplus energy node after a comparison to cluster members' nodes energy's and the elected node becomes the cluster head. This guarantees a balanced energy distribution of all cluster members. In the first round of networks, if the threshold node $i > T(n)$, the node i has become the cluster head. In the second round, the largest energy of node becomes the cluster head, then the node i broadcasts the message of becoming the cluster head that sends all the collected data of the cluster members to BS by multi-hop transmission. Subsequently, it saves the energy consumption of cluster head when Sink node is very far in WSN. Selecting another next-elected cluster head in data transmission has an important influence on the overall energy consumption of CH.

The current CH and its next-elected cluster head are able to optimize the next elected cluster head selection in order to ensure a minimum energy dissipation of the data transmission to BS. Following the same manner, the next elected CH is selected based on this

weighting function and the data are sent using the next elected CH. Each node has the lowest function is elected as CH that transmits all data to BS. The weighting function is described in the below equation 5.

$$F(i,j)=\left[\frac{S(i).E}{S(i).max}\right]+\left[\frac{[d(i,j)^2+d(j,s)^2]}{d(i,s)^2}\right] \quad (5)$$

Where:

i is the sensor **i**,

S(i).E is the remaining energy of the **CH_i**,

S(i).max is battery capacity the **CH_i**,

CH_i is the cluster head **i**,

CH_j is the cluster head **j**,

SB is the base station,

j is the **jth** neighbor of sensor **i**,

d(i,j) is the distance between node **CH_i** and adjacent **CH_j** and **d(j,S)** is the distance between **CH_j** and Sink node.

P is the cluster-head probability in the round **r**

G the set of nodes that were'nt cluster-head in the first round

$$d(i,j)=\sqrt{(X_j-X_i)^2+(Y_j-Y_i)^2}$$

Considering only the distance between the **CH_i** and **CH_j** (its next-hop cluster head), by the weight function, and taking into account only the residual energy of the cluster_head transmitter (**CH_j**) ignores other factors that affect the energy consumption and the network lifetime. In fact, in the cases where the next-hop cluster head (**CH_j**) is depleted of energy or overloaded, the sent data will be certainly lost. This turns clearly to be a disadvantage. It is not always a-guarantee to transmit data to BS because of the selection of the next-hop CH which depends on the distance separating it and the CH transmitter $d(CH_i, CH_j)$ and its residual energy.

Integrating the Artificial Intelligence (AI) in WSN challenges is to solve different problems in this field [2], which has made a fuzzy logic. Subsequently, it is one of the most important paradigms used for real-time decisions in WSN relying on the output results of the fuzzy inference system [4]. Numerous studies,thereafter, presented these protocols using FL [25] [26] [27] for the CH election and the cluster construction. Within this context, our

method actually solves these problems just as it executes an intelligent localization algorithm of nodes relying on an intelligent fuzzy logic technique for next-hop CH selection. As a consequence, the results of the experience show that the proposed clustering scheme is performing better than the previously mentioned protocols.

Actually, two different radio models are used during the transmission phase. As well as, they are free space model and the multipath fading channel model [28]. When the distance between the transmitter and the receiver is less than the threshold value d_0 , the algorithm adopts the free space model (d^2 power loss). Otherwise, the algorithm adopts the multi-path fading channel model (d^4 power loss). So if the transmitter sends an l-bit message to the receiver up to a distance of d, the energy consumption of the transmitter and the receiver can be calculated as follows:

$$E_{Tx}(k, d) = E_{Tx}(l) + E_{Txamp}(k, d)$$

$$E_{Tx}(k, d) = k \cdot E_{elec}(k, d) + k \cdot \epsilon_{fs} d^2 \quad \text{if } d \leq d_{crossover} \quad (6)$$

$$= k \cdot E_{elec}(k, d) + k \cdot \epsilon_{amp} d \quad \text{else}$$

$$E_{Rx}(k) = E_{Rx_{elec}}(k) = k \cdot E_{elec}$$

Where:

- $E_{Tx}(k, d)$ is the energy consumption of the transmitter which sends a k-bit message to the receiver up to a distance of d ;
- $E_{Rx_{elec}}(k)$ is the energy consumption of the receiver which receives a k-bit message;
- E_{elec} is the energy consumption of the wireless send-receive circuit;
- ϵ_{fs} and ϵ_{amp} represent the energy consumption factor of the amplification in the two radio models.

3.4 Fuzzy Inference System (FIS)

Fuzzy Inference Systems consist of three stages : an input, an output and a processing phase [52] [53]. The input part receives inputs and maps these using membership functions to truth values. Then, processing stage generate results from a set of invoked rules. Finally, results are given as specific value by the output phase. The membership function describes the truth degree and can be modeled by a curve form defining the manner of mapping each point in the input space to a degree of membership belonging in the interval [0..1]. Different forms can be used as triangular and trapezoidal functions [54]. The inference engine is based on a set of fuzzy rules in the form of IF-THEN statements, where the IF clause is called the

"antecedent" and the THEN clause is called the "consequent". Each value of membership function is called linguistic terms. The fundamental steps in the fuzzy inference are : Fuzzify inputs definition, fuzzy operator application, implication method application, outputs aggregation, outputs defuzzification [54]. Firstly, inputs are specified and their belonging degree are determined. Fuzzification process consists of defining for each input and output variable a set of membership functions (MF).

Once the input and output variables and MF are defined, we have to design the rule-base composed of IF THEN rules. These rules transform the input variables to an output.

Next step is is to compute the degree of membership to the MF of the output. Once the input variable is fuzzified it have a value between 0 and 1 specifying the degree of membership. The degrees of membership of the input variables are combined to get the degree of membership of the output variable.

After this, the the implication function updates the output fuzzy set until becomes equal to the degree specified by the antecedent. Then, each rule should be combined in order to generate a final decision after testing all the rules in the Fuzzy Inference Subsystem (FIS). Combining the output into a single fuzzy value is the process called aggregation, this stage occurs for each output variable. The result of this last stage is an aggregate output fuzzy set representing the input for the defuzzification stage.

This stage is the process of producing a quantifiable result in crisp logic, given fuzzy sets and corresponding membership degrees. It is the process that maps a fuzzy set to a crisp set. These will have a number of rules that transform a number of variables into a fuzzy result, that is, the result is described in terms of membership in fuzzy sets. It is interpreting the membership degrees of the fuzzy sets into a specific decision or real value.

There are two common inference methods [54]: Mamdani's fuzzy inference method proposed in 1975 by Ebrahim Mamdani [55] and Takagi-Sugeno-Kang, method of fuzzy inference introduced in 1985 [56].

Fuzzy Inference System (FIS) [28] is used to select the next elected cluster head, where four inputs are entered to FIS in order to calculate a fuzzy cost. According to the fuzzy cost, the next hop is chosen and the next CH is elected. The residual energy of the current CH, the distance between the current CH and the next elected CH, the distance between the next elected CH and the BS (calculated relatively to location algorithm, previously implemented, of sensor nodes) and the density of the next elected CH are all the inputs of FIS.

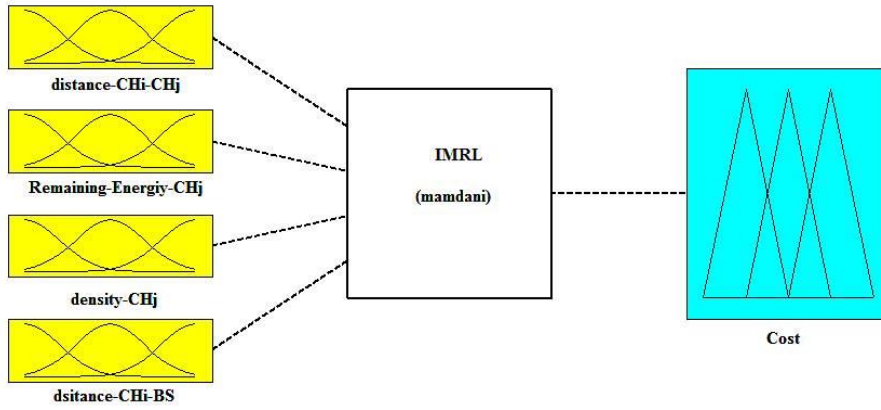

Figure 7. The proposed FL System model

Fuzzy sets of input variables are shown in figure 8(a), figure 8(b), figure 8(c) and figure 8(d).

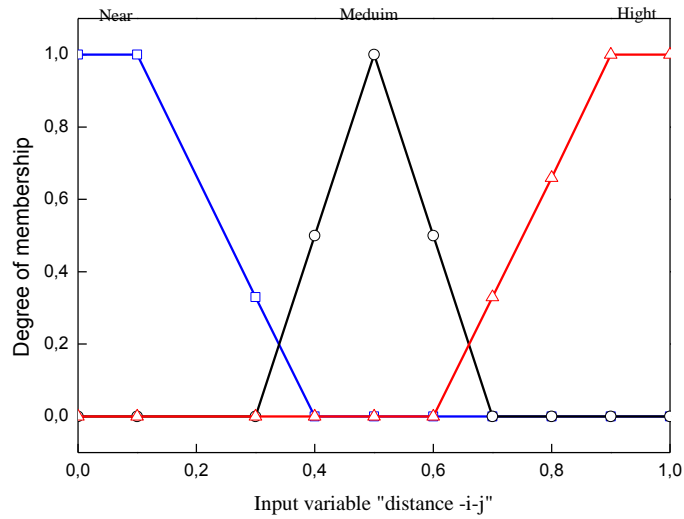

Figure 8(a). Membership function for input 'distance-CHi-CHj'

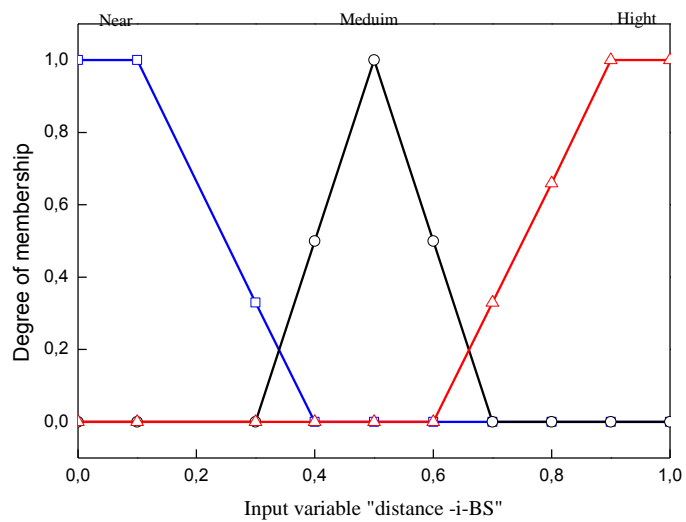

Figure 8(b). Membership function for input 'distance-CHI-BS

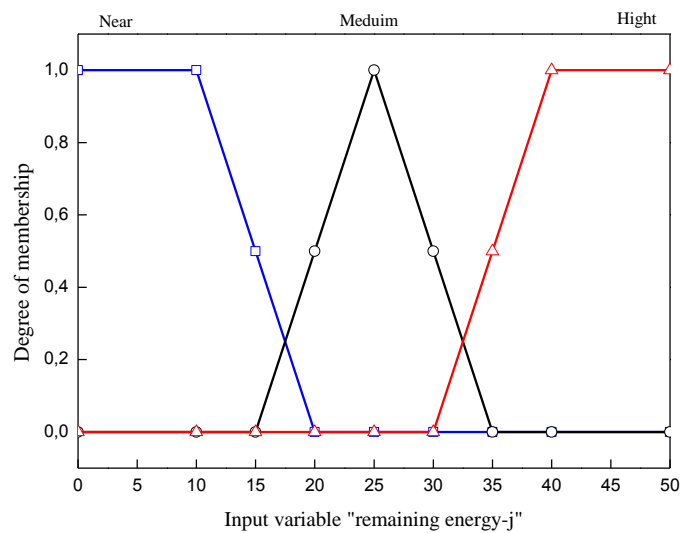

Figure 8(b). Membership function for input 'Remaining-Energy-CHj'

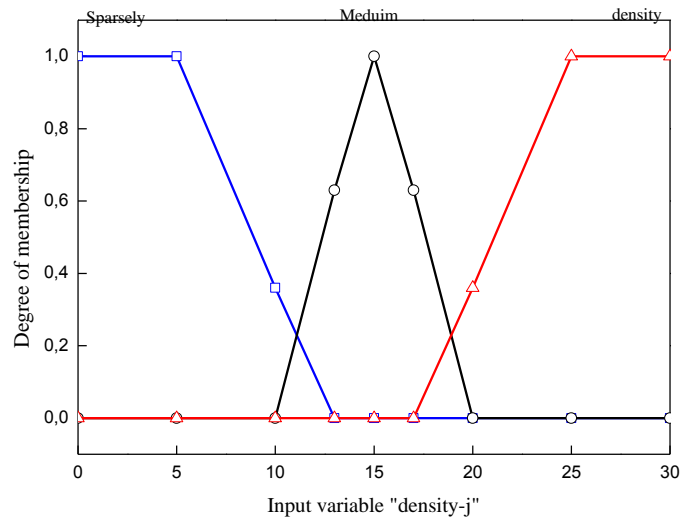

Figure 8(c). Membership function for input ‘density-CHj’

The output (fuzzy cost) for this FIS is shown in figure 5(e).

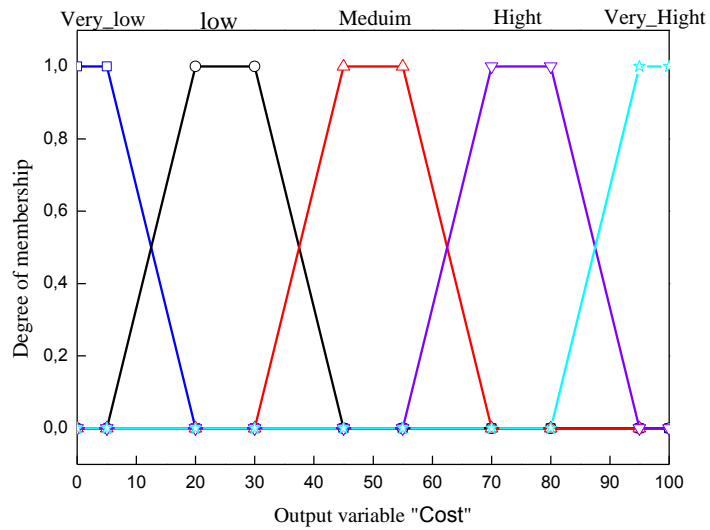

Figure8(e). Membership function for output ‘cost’

Membership variables of output parameter are; VL (Very Low), L (Low), M(Medium), H(High) and VH(Very High). 81 IF the fuzzy rules are used to take decision for next CH election.

3.5. *IMRL algorithm*

In this sub-section, we describe our IMRL algorithm,

IMRL algorithm

Start Algorithm IMRL

Let i be the sensor i ;

Let BS be the base station;

Let j be the j^{th} neighbor of the sensor i ;
 CH _{i} sends data to BS
 Let BS the base station
 P is the cluster-head probability in the round r
 Let $T(n)$ is calculated as :

$$T(n) = \frac{P}{1 - p \times (r \bmod \frac{1}{p})} \quad \text{sin} \in G$$

I. Initial round

1. If i^{th} node threshold $> T(n)$, i^{th} node announces and becomes the CH;
 CH_msg (CH message),
2. Cluster formation and data transmission.
3. Each i^{th} CH calculates his distance from the Sink node D (CH _{j} , BS) using intelligent localization algorithm and sends it to the other CHs.

II. General Tours

1. The node with more energy among the member nodes announces and becomes the CH:
 CH_msg (CH message).
2. Cluster formation and data transmission.
3. For each CH _{i}
 - If Distance (CH _{j} , BS) $<$ Distance (CH _{i} , CH _{j}) then
 CH _{i} sends data to SB
 - Else
 - For each CH _{j}
 - CH _{i} calculates a cost for each hop between itself and other neighboring CHs using fuzzy logic system Cost (CH _{j} , CH _{$1..n-1$})
 - End For
4. CH _{i} transmits data to CH _{j} with optimal next hop cost
- End if
- End For

End_Algorithm IMRL

4. Simulation and experimental results

4.1. Simulation setup

In this section, simulation experiments are implemented to study the accuracy of proposed mechanism (localization algorithm and routing protocol) based on grid scan in Matlab.

We set up and study the simulation results of the suggested algorithm. We compare, therefore, the PERLA, and the MEVI algorithms with our proposals relying on the famous weighting function equation. Besides, we provide the simulation results procured under the following simulation conditions. The metrics for the performance evaluation are accuracy localization, energy consumption, number of transmitted packets, number of dead nodes and transmission time, as they constitute the most critical parameters in wireless sensor networks. Note that 100 sensor nodes are randomly placed in a square area with a size of 100x100 m. The simulation results were executed several times in a random order. We have used the fuzzy logic technique in to assess the overall performance of the proposed algorithm. Simulations

are, in fact, realized using the MATLAB simulator. The results are eventually achieved using the average of 100 simulations. Table III summarizes the values of the main simulation parameters.

TABLE III. SIMULATION PARAMETERS

<i>Parameters</i>	<i>Values</i>
Number of nodes	100
Number of rounds	500
Field size	100m × 100m
data packet size	6400 bits
control packet size (l)	200 bits
electronics energy (Eelec)	50 nJ / bit
efs	10 pJ/bit/m ²
emp	0.0013 pJ / bit / m ⁴
Initial of energy of node	0,5 J

4.2. Accuracy of Localization

In this scenario, we deploy 60 sensor nodes, which were distributed randomly, and 110 anchor nodes that were handed out evenly as shown in Fig. 9. Communication radio door of the sensor nodes is 10 meters.

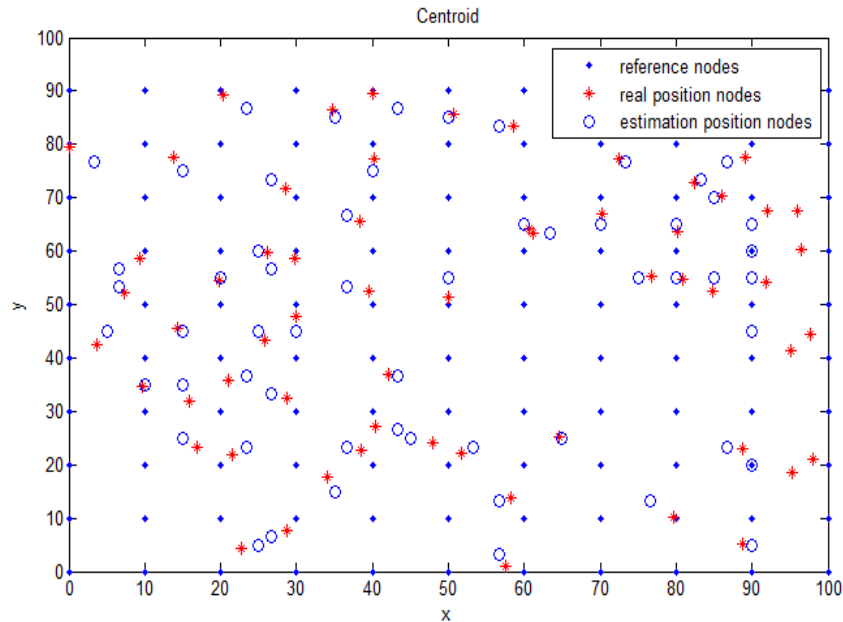

Figure 9. Nodes distribution

Three localization techniques (Simple centroid approach, Mamdani fuzzy approach, Sugeno fuzzy approach) are simulated and compared to the two proposed localization techniques. These localization techniques have been already simulated. Fig.10, 11 and 12 show both the position estimation and localization error results of these methods respectively.

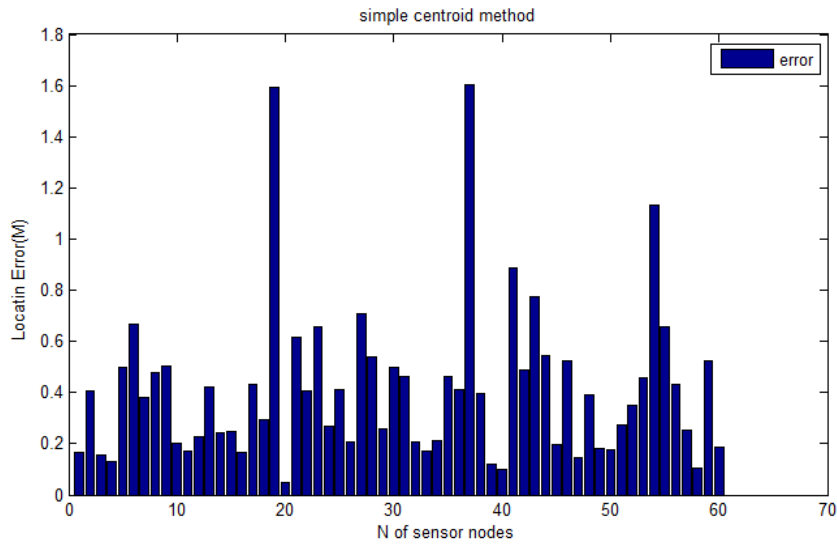

Figure 10. Localization error for simple centroid method

Fig. 10 shows currently the localization error results. Based on a simple centroid technique, the error of the largest localization is 1.6m and the most basic error is 0.18 m. However, the simulation result shows that the accuracy location for a simple centroid technique is badly used that is why Mamdani’s technique was effectively used.

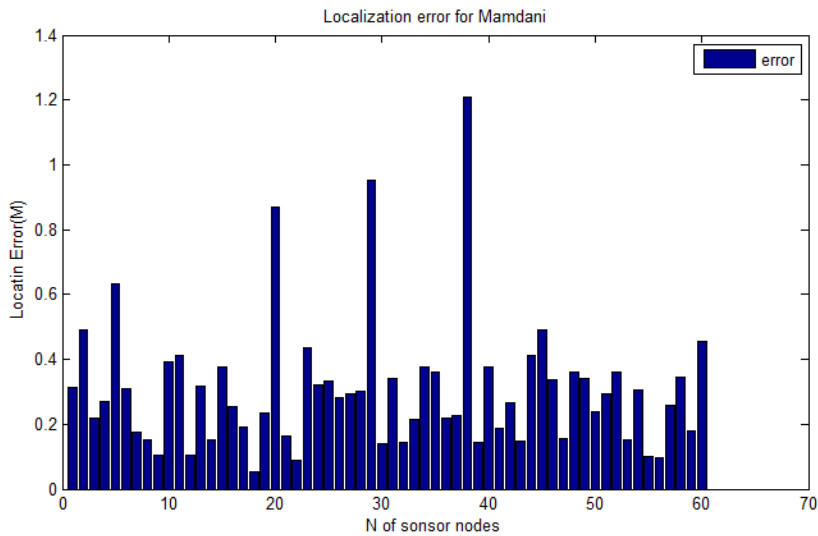

Figure 11. Localization error for Mamdani

Fig. 11 shows localization error results. Although the use of Mamdani technique, the error of the largest localization is 1.2m and the most basic error is equal to 0.15m. As a result it is clear that the localization of the node using Mamdani technique is quite poor.

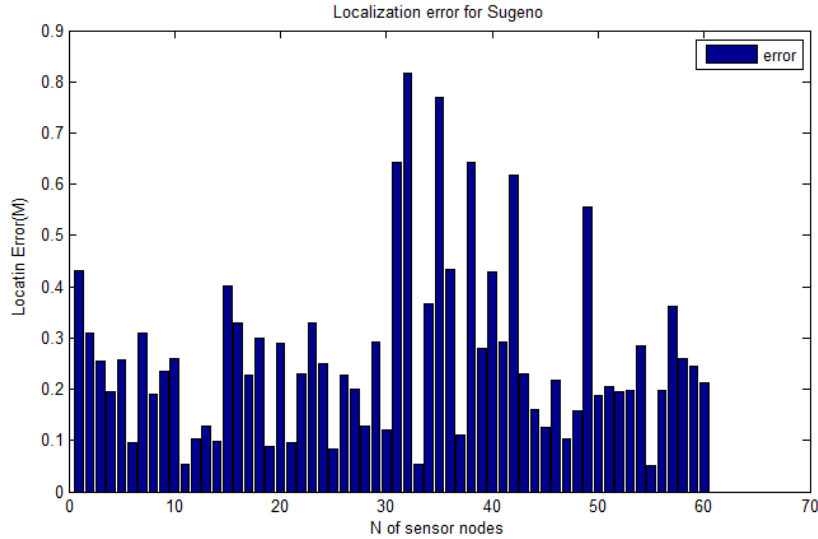

Fig.12 shows localization error results.

Despite the application of Sugeno technique, the error of the largest localization is 0.85m and the most basic error is 0.05m. Subsequently, it seems clear that the localization node of using Sugeno technique is very good. Table IV shows comparative results of the error location using the proposed method and the existing techniques.

TABLE IV. COMPARISON RESULTS FOR DIFFERENT APPROACHES

<i>Approaches</i>	Location error(meters)					
	<i>Proposed method</i>		<i>[29]</i>		<i>[30]</i>	
	<i>Max</i>	<i>Min</i>	<i>Max</i>	<i>Min</i>	<i>Max</i>	<i>Min</i>
Simple centroid	1.60	0.18	3.16	0	3.57	0.213
Mamdani fuzzy	1.20	0.15	2.02	0	2.01	0.12
Sugeno fuzzy	0.85	0.05	2.01	0	1.96	0.14

In this simulation scenario, we evaluate the performance of three localization algorithms (centroid, Mamdani fuzzy and Sugeno fuzzy) in terms of average position error. We compare the error average position to the centroid algorithm, fuzzy Mamdani method and fuzzy Sugeno method. Then, we analyzes the influence of fuzzy logic about the error means position in the localization algorithm. Hence, the comparison of average localization error of three proposed algorithms is shown in figure 13.

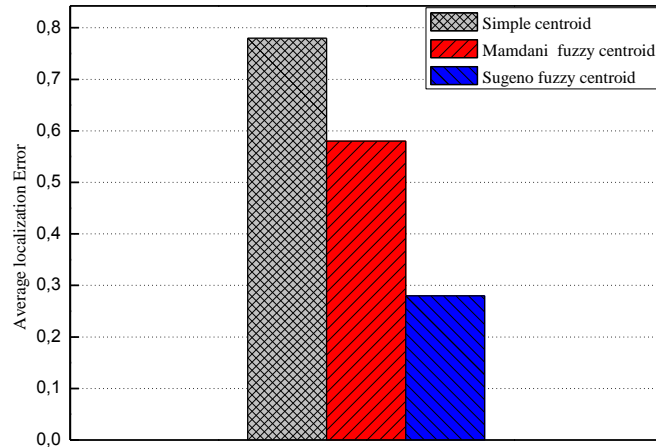

Figure13. Average localization Error

As shown in Fig. 13, the sugeno technique achieves a better performance than the centroid and Mamdani techniques together. For example, using Sugeno method we get an average of error location equals to 0.3m while a simple centroid is 0.8m. Eventually, in this case, the improvement is mostly satisfied by Sugeno method and which can be seen from Table 5 comparing the traditional centroid to the improved algorithms.

TABLE V. COMPARISON RESULTS OF AVERAGE LOCALIZATION ERROR FOR DIFFERENT APPROACHES

	Average localization error(m)		
	Proposed method	[29]	[30]
Simple centroid	0.80	1.60	1.68
Mamdani fuzzy	0.50	0.89	0.89
Sugeno fuzzy	0.30	0.94	0.94

Table V shows our algorithm performance. It can be seen that the improvement of this algorithm increases significantly the accuracy of the nodes using the centroid algorithm. It is an effective approach for node localization in WSN.

Sugeno method is efficient and works well with optimization and adaptive techniques, which makes it very performant in control problems, particularly for dynamic nonlinear systems [57]. The difference between Mamdanitype FIS and Sugeno-type FIS is in the method of crisp output generation from the fuzzy inputs [58]. While Mamdani-type FIS uses the defuzzification technique of a fuzzy output, Sugeno-type FIS uses weighted average to compute the crisp output [26], so the Sugeno's output membership functions are either linear

or constant but Mamdani's inference expects the output membership functions to be fuzzy sets. Furthermore, Sugeno method has better processing time since the weighted average replace the time consuming defuzzification process. Sugeno's method possesses three advantages: (1) it is computationally efficient; (2) it works well with optimization and adaptive techniques, it matches so much dynamic nonlinear systems; (3) it is so convenient to mathematical analysis [59]. The performance of Sugeno method is better than Mamdani method for the same fuzzy technique.

4.3. *Cost of transmission: energy consumption, overhead, and network lifetime*

In simulation phase, we compare our proposed mechanism (Intelligent Mechanism for Routing data based on Nodes localization IMRL) with Multi-hop hierarchical routing protocol for the Efficient Video communication for WMSN called (MEVI) [31]. Power efficient range-free localization algorithm for wireless sensor networks (PERLA) [39]. To prove our proposed mechanism, we create 2 simulations scenarios where the nodes locations were calculated using RSSI parameter. In the first scenario (Scenario1), we calculate the weighting function to select the next elected CH.

$$S(CH_i)=0.3J,$$

$$d(CH_i,S)=66.88m,$$

$$d(CH_i,N_1)=9.43m,$$

$$d(CH_i,N_2)=2m,$$

$$d(CH_i,N_3)=8.6m,$$

$$d(N_i,S)=76.32m,$$

$$d(N_j,S)=65.19m,$$

$$d(N_k,S)=58.30m,$$

$$CH(15,18),$$

$$S(50,75),$$

$$N_i(10,10),$$

$$N_j(15,20),$$

$$N_k(20,25).$$

$$F(CH_i, N_i) = \left[\frac{S(CH_i).E}{S(CH_i).max} \right] + \left[\frac{[d(CH_i, N_i)^2 + d(N_i, S)^2]}{d(CH_i, S)^2} \right] = 1.92$$

$$F(CH_i, N_j) = \left[\frac{S(CH_i).E}{S(CH_i).max} \right] + \left[\frac{[d(CH_i, N_j)^2 + d(N_j, S)^2]}{d(CH_i, S)^2} \right] = 1.55$$

$$F(\text{CH}_i, N_k) = \left[\frac{S(\text{CH}_i) \cdot E}{S(\text{CH}_i) \cdot \max} \right] + \left[\frac{[d(\text{CH}_i, N_k)^2 + d(N_k, S)^2]}{d(\text{CH}_i, S)^2} \right] = 1.37$$

According to the calculation of the function, it is clear that the next elected CH is CH3. After this treatment, $S(\text{CH}_i)=0,024\text{J}$.

In the second scenario (Scenario2), we execute our intelligent algorithm of localization in order to reduce the error of the nodes localization and to select the next elected CH using the inference system instead of the weighting function. Above all, the use of our localization algorithm allows us to minimize the position error of nodes. Thereafter, a more accurate calculation of the distances between the CHs and cluster member nodes is realized. Then, these distances between the CH transmitter and its adjacent next-hop CH and those between the next-hop CH and the BS are used as inputs to the inference system having as output the next elected CH just following this treatment, $S(\text{CH}_i)=0,027\text{J}$.

As shown in the figures below, the simulation results show that our approach extends the network lifetime significantly as compared to the PERLA protocol. In addition, our simulations show that the nodes consume less energy compared to the MEVI. The obtained results attest of the efficiency of our approach when compared to other proposed protocols for similar purposes.

Fig. 14 shows the energy consumption of the proposed system compared to both of PERLA and MEVI protocols.

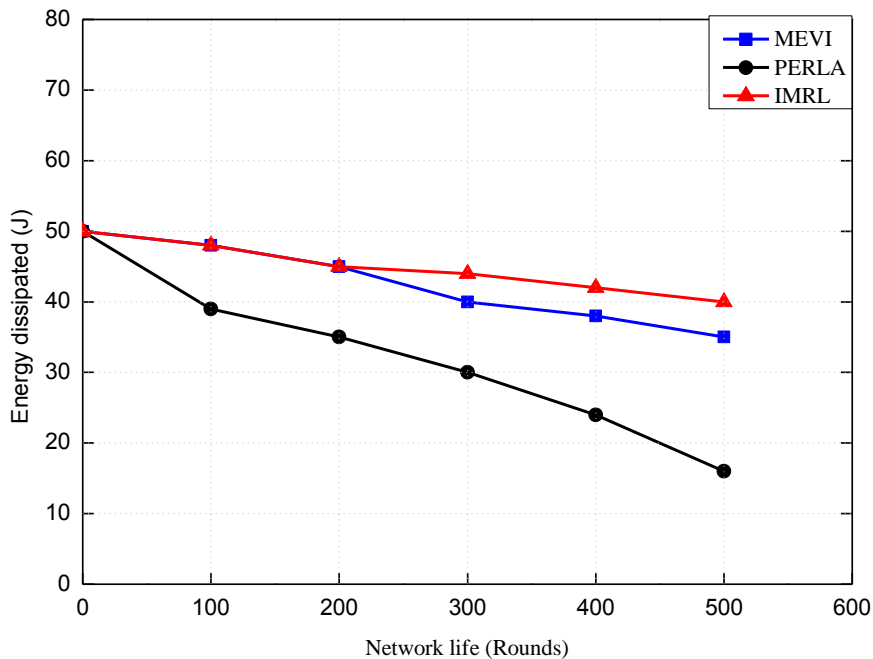

Figure14. Comparison in terms of total energy dissipated

The energy consumption rates of the proposed mechanism is less than MEVI protocol and lower than PERLA protocol. As a result, we can see from Figure 11 that IMRL helps the nodes to consume energy in a uniform way. IMRL is better than PERLA to about 300% in the last round. It still consumes more than 2J compared to MEVI protocol.

Fig.15 shows the comparison of our mechanism with other protocol in terms of the number of packets transmitted to the BS.

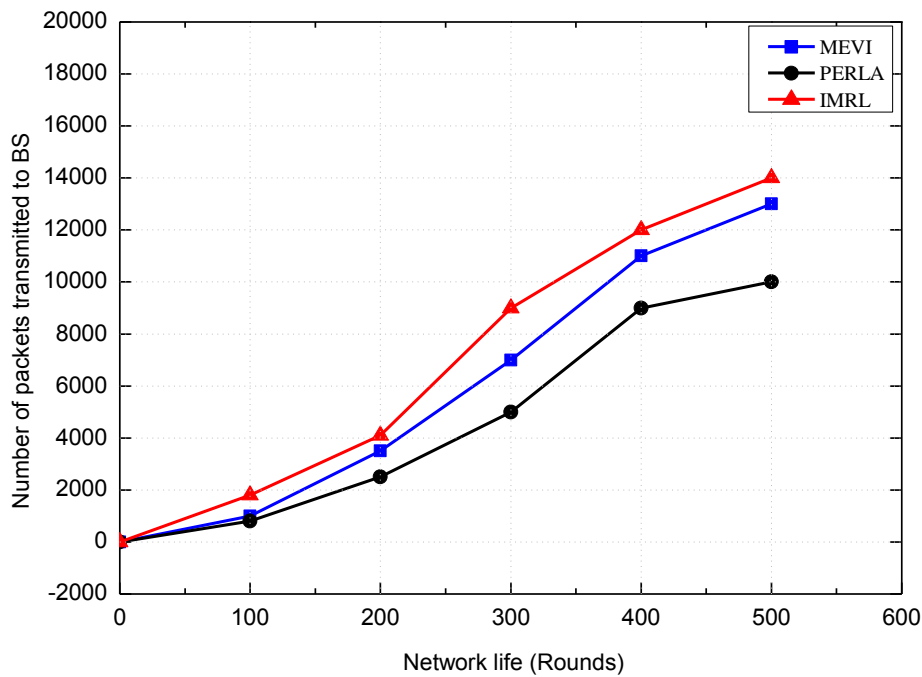

Figure 15. Comparison in terms of total data received by the BS

During 500 laps, the base station receives more than 13000 packets using IMRL proposed protocol. However, 12500 packets and less than 10000 packets are transmitted to BS using MEVI and PERLA protocols respectively.

Figure 16 presents the number of dead nodes using our system compared with MEVI and PERLA.

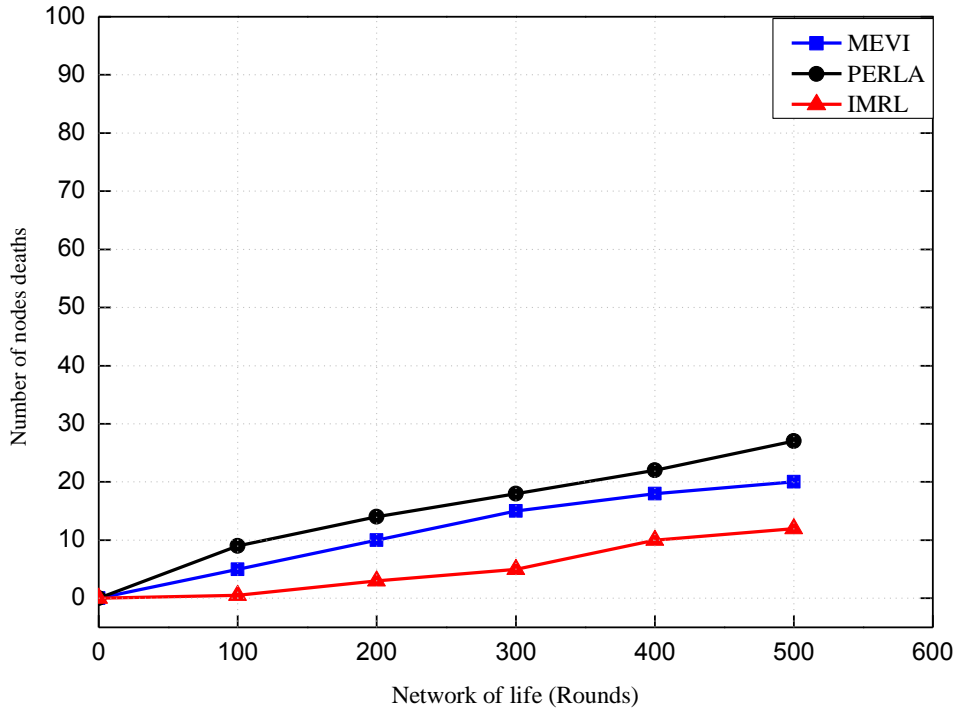

Figure16. Comparison in terms of dead nodes

The death of the first node using MEVI and PERLA are at round 150 and round 50 respectively whereas the first node died at the round 200 with IMRL. This number does not exceed 9 dead nodes among 100 nodes for the proposed protocol. More than 15 nodes are deeded using MEVI and more than 25 nodes are deeded using PERLA protocol. The lifetime of the network is longer using the proposed method. The table below summarizes the simulation results by comparing the three protocols.

TABLE VI. SUMMARY OF SIMULATION RESULTS

<i>Evaluation metrics</i>	<i>Network life</i>	<i>PERLA</i>	<i>MEVI</i>	<i>IMRL</i>
Energy dissipated (J)/ (Total energy)	500 rounds	35/50	16/50	13/50
Number of packets transmitted to base station	500 rounds	10000	12500	13500
Number of dead nodes / (total nodes)	500 rounds	27/100	20/100	9 /100

Table VI summarizes the evaluation results of the proposed method compared to other protocols using numerical values. First, the proposed protocol is better than PERLA protocol in terms of total energy dissipated by the nodes as consumes only 13J from 50J unlike it

consumes 35 from 50J for PERLA. Using MEVI protocol, the nodes consume 16J of total energy 50J.

For 500 laps, the base station receives more than 13500 packets using proposed method. However, this number decreased to 12500 packets using MEVI and up to 10000 using PERLA.

Finally, 9 nodes were deeded from 100 during 500 rounds using the proposed method. This number increases to 20 nodes died during the same lifetime of the network using MEVI. At the end, 27 sensor nodes were deeded from 100 using PERLA.

4.4 Transmission time

The first table shows the transmission time of the data after a consumed energy level equal to 0.1J by the two protocols and the proposed mechanism.

TABLE VII. Transmission time vs energy consumption

	Per round	Transmission time
PERLA	0.05	700
MEVI	0 .03	687
IMRL	0.01	659

In fact, at a remaining level of energy equal to 0.4 J per each node, the transmission time for the PERLA protocol is 1335 (ms), 1320 (ms) for MEVI and 1259 (ms) for our proposed mechanism.

The second table shows the transmission time of the data in (ms) with respect to the energy consumed (per revolution) by the two PERLA and MEVI protocols combined with the proposed protocol.

TABLE VIII. Transmission time vs energy consumption (Per round)

	Energy consumption (Per round)	Transmission time
PERLA	0.4	1335
MEVI	0 .4	1320
IMRL	0.4	1259

In fact the transmission time for the PERLA protocol is 700 (ms), for the MEVI protocol is 687 (ms) and for our proposed mechanism is 659 (ms). It is clear that our mechanism is more efficient in terms of transmission time

4.4 Sensitivity analysis

For the sensitivity analysis, we modeled the WSN by an undirected probabilistic graph $G(V, E)$, where sensor nodes are represented by a set of vertices V ; the links between pairs of nodes are represented by a set of edges E . We evaluate the Infrastructure Communication Reliability (ICR) [42] using the binary decision diagrams (BDD) [43][44][45]. The BDD-based method is used for the sensitivity analysis of our WSN. BDD is a directed acyclic graph composed of two sink nodes and other nodes [46][47]. We followed these steps to generate the BDD algorithm for network reliability evaluation [44]:

1. Listing all path-sets.
2. Converting each path-set to an equivalent BDD
3. Generating the final network BDD
4. Calculating the the ICR by summing the probabilities of all the disjoint paths from the root node to sink node and can be evaluated as:

$$ICR = \Pr(\text{path } 1) + \Pr(\text{path } 2) + \dots + \Pr(\text{path } x) = \sum_{i=1}^x \Pr(\text{path } i)$$

Where $\Pr(\text{path } i)$ is the probability obtained from path i from x paths.

Structural importance measure evaluates the importance of a component by its location [48][49].

It can be calculated as Birnbaum's measure [50] of component c with all the component reliabilities $p_j = 1/2$ for $j \neq c$, which is:

$$I_{SI}(c) = I_{BM}(c) \Big|_{p_i = \frac{1}{2}, j \neq c}$$

Birnbaum's measure [50], defined as a partial derivative of the system reliability with respect to the component reliability, measures the sensitivity of the system reliability to the changes in the component reliability. The importance of a component c (link or node) in the infrastructure communication of WSN is the partial derivative of ICR with respect to the reliability of component c , denoted by p_c , that is:

$$I_{BM}(c) = \frac{\partial CR}{\partial p_c}$$

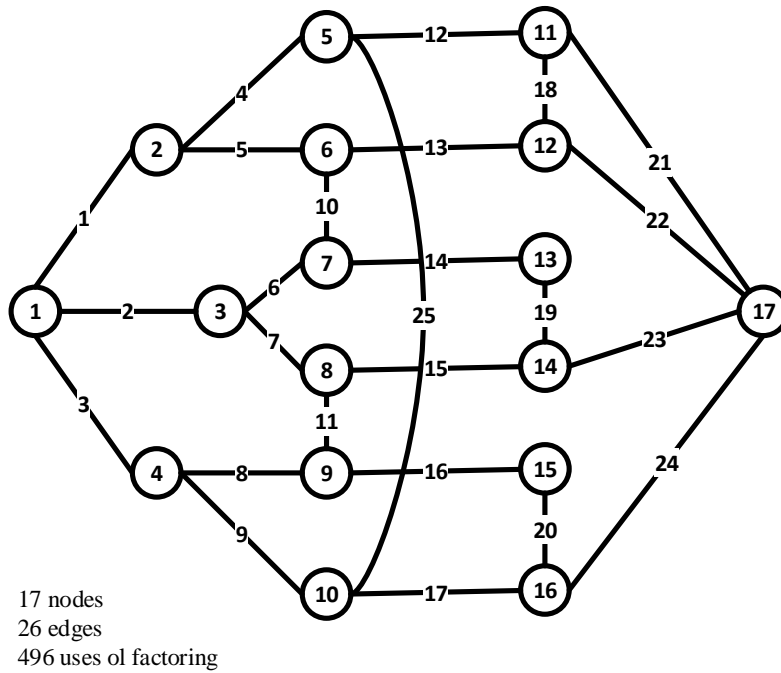

Figure 17. Network Used to Test Algorithms of Buzacott, Provan, Ball, and Kulkarni & Bailey [60]

To measure the component reliability, we study the relationship between node degree and structural importance. A representative WSN graphs in Figure 17 is selected from benchmark graphs in Chang et al [51].

TABLE IX. Structural Importance

Nodes	Structural Importance
1	0.092
2	0.053
3	0.049
4	0.048
5	0.36
6	0.038
7	0.026
8	0.025
9	0.022
11	0.063
12	0.066
13	0.016
14	0.043
15	0.019
16	0.058
17	0

The component reliability varies according to applied data delivery models. We analyze component sensitivity under infrastructure communication of WSN with different data delivery models. Graph in Figure 17 is studied. The source node (base station) is node 1. The sensor nodes in the qualified group for anycast, multicast, and unicast are node 11, node 12, node 14, node 16, and node 17. For broadcast, all sensor nodes receive the message from the source node. Table IX introduces the structural importance of all the nodes. According to Table IX, the source node (node 1) is the most important node because communication fails if the source node fails. For anycast, node 17 is the least important node of all the nodes because node 17 contributes the least to the communication; if the source node can communicate to node 11 or node 12 or node 14 or node 16 successfully, the communication succeeds, else the communication mission fails no matter the state of node 17. It can be also seen that link 1 is the most important link among all links for all the data delivery models. Link 19, link 20, link 21, link 22, link 23, link 24 and link 25 are links which connect two sensor nodes in the qualified group directly. For anycast, these links are less important because failure of any of the three links has no effect on the communication.

4.5 Discussion

Our contribution is well achieved and validated by simulation results. First, considering the localization error results, it is clear that (1) the accuracy location for a simple centroid technique is badly used, (2) localization of the node using Mamdani technique is quite poor, localizing nodes using Sugeno technique is very good, (3) the Sugeno technique achieves a better performance than the centroid and Mamdani techniques together.

Second, after execution of intelligent algorithm of localization that reduce the error of the nodes localization, select the next elected CH using the inference system instead of the weighting function, minimize the position error of nodes, (1) the simulation results show that our approach extends the network lifetime significantly as compared to the PERLA protocol. In addition, our simulations (2) show that the nodes consume less energy compared to the MEVI. The obtained results attest of the efficiency of our approach when compared to other proposed protocols for similar purposes. (3) The energy consumption rates of the proposed mechanism is less than MEVI protocol and lower than PERLA protocol. (4) IMRL helps the nodes to consume energy in a uniform way. (5) using proposed mechanism, the base station receives a number of packets more better than MEVI and PERLA protocols. (6) considering the death of the first node and the number of dead nodes, it is clear that proposed mechanism

is more performant than MEVI and PERLA protocols. (7) Simulations results show that the lifetime of the network is much longer using the proposed method.

5. Conclusion

In this paper, we have implemented a localization algorithm range-free for wireless sensor networks using RSSI information between sensor and anchor nodes as an input of fuzzy inference system to estimate the position of the edge nodes. The proposed mechanism is based on weighted centroid localization technique, where the locations of unknown nodes of SNs are computed based on a fuzzy logic inference based on RSSI values between the nodes. Thereafter, the suggested algorithm uses measurement of the flow through wireless channel to determine the distance between the anchor nodes and the sensor nodes. Our work is based on the centroid algorithm that calculates the location of unknown nodes using fuzzy Mamdani and Sugeno inference system for increasing the accuracy of estimated position. After calculating precisely the position of nodes, we proceed to an effective selection of the next-hop CH to reduce the energy dissipation of sensor nodes and to extend the network lifetime. Actually, the attained solution is based on four parameters: the energy level of current CH at a given time, the distance between current CH and the next elected CH, the distance between the next elected CH and BS, the density of next elected CH. For the next elected CH selection, each current CH node applies Mamdani Fuzzy Inference System [8] to join the hop having a minimum cost value for to send data. Recognizing well that the distance between current CH and the next elected CH as well as the distance between next elected CH and BS are calculated referring back to localization algorithm previously described. By executing our mechanism, we have succeeded to save energy with 56% compared to PERLA protocol and about 6% compared to classic MEVI protocol. Concerning the number of the packets transmitted to the base station, the proposed mechanism is more efficient than MEVI with 30% and with 6.6% compared to PERLA protocol. In addition, we have minimized the number of dead nodes with 3% compared to MEVI and 48.99% compared to PERLA protocol. We have improved the transmission time compared to MEVI. It is clear that the proposed mechanism is a performing solution for electing the optimal next CH in order to transmit data until the base station.

In the future works, we will try to improve the performance of our mechanism simply by applying other intelligent techniques such as the method of neural networks and comparing it to other routing protocols and taking into account other performance criteria.

Acknowledgements

The authors would like to acknowledge the financial support of this research by granting the ARUB program under the jurisdiction of the General Direction of Scientific Research (DGRST) (Tunisia).

References

- [1] Bradai, A., Benslimane, A., & Singh, K. D. (2015). Dynamic anchor points selection for mobility management in Software Defined Networks. *Journal of Network and Computer Applications*, 57, 1-11..
- [2] Lee, J. S., & Cheng, W. L. (2012). Fuzzy-logic-based clustering approach for wireless sensor networks using energy predication. *Sensors Journal, IEEE*, 12(9), 2891-2897.
- [3] Kulkarni, R. V., Förster, A., & Venayagamoorthy, G. K. (2011). Computational intelligence in wireless sensor networks: a survey. *Communications Surveys & Tutorials, IEEE*, 13(1), 68-96.
- [4] Yick, J., Mukherjee, B., & Ghosal, D. (2008). Wireless sensor network survey. *Computer networks*, 52(12), 2292-2330.
- [5] Ando, H., Wang, Q., Barolli, L., Kulla, E., Durrresi, A., & Xhafa, F. (2011, November). A Fuzzy-based Cluster-Head Selection System for WSNs Considering Sensor Node Movement. In *Intelligent Networking and Collaborative Systems (INCoS), 2011 Third International Conference on* (pp. 130-135). IEEE.
- [6] He, T., Huang, C., Blum, B. M., Stankovic, J. A., & Abdelzaher, T. (2003, September). Range-free localization schemes for large scale sensor networks. In *Proceedings of the 9th annual international conference on Mobile computing and networking* (pp. 81-95). ACM.
- [7] Sheu, J. P., Chen, P. C., & Hsu, C. S. (2008). A distributed localization scheme for wireless sensor networks with improved grid-scan and vector-based refinement. *Mobile Computing, IEEE Transactions on*, 7(9), 1110-1123.
- [8] Pottie, G. J., & Kaiser, W. J. (2000). Wireless integrated network sensors. *Communications of the ACM*, 43(5), 51-58.
- [9] Hightower, J., & Borriello, G. (2001). Location systems for ubiquitous computing. *Computer*, (8), 57-66.
- [10] Priyantha, N. B., Chakraborty, A., & Balakrishnan, H. (2000, August). The cricket location-support system. In *Proceedings of the 6th annual international conference on Mobile computing and networking* (pp. 32-43). ACM.
- [11] Savvides, A., Han, C. C., & Strivastava, M. B. (2001, July). Dynamic fine-grained localization in ad-hoc networks of sensors. In *Proceedings of the 7th annual international conference on Mobile computing and networking* (pp. 166-179). ACM.
- [12] Kumar, A., Kumar, V., & Kapoor, V. (2011, February). Range free localization schemes for wireless sensor networks. In *the 10th WSEAS International Conference on Software Engineering, Cambridge, UK*(pp. 101-106).
- [13] Doherty, L., Pister, K. S., & El Ghaoui, L. (2001). Convex position estimation in wireless sensor networks. In *INFOCOM 2001. Twentieth Annual Joint Conference of the IEEE Computer and Communications Societies. Proceedings. IEEE* (Vol. 3, pp. 1655-1663). IEEE.

- [14] Taheri, H., Neamatollahi, P., Younis, O. M., Naghibzadeh, S., & Yaghmaee, M. H. (2012). An energy-aware distributed clustering protocol in wireless sensor networks using fuzzy logic. *Ad Hoc Networks*, 10(7), 1469-1481.
- [15] Zhu, J., & Papavassiliou, S. (2003). On the energy-efficient organization and the lifetime of multi-hop sensor networks. *Communications Letters, IEEE*, 7(11), 537-539.
- [16] Liu, S. C. (2006, May). A lifetime-extending deployment strategy for multi-hop wireless sensor networks. In *Communication Networks and Services Research Conference, 2006. CNSR 2006. Proceedings of the 4th Annual* (pp. 8-pp). IEEE.
- [17] Hong, S. I., & Lin, C. H. (2016, January). An expansion cluster routing algorithm based on RSSI for an efficient data transmission. In *2016 18th International Conference on Advanced Communication Technology (ICACT)* (pp. 31-33). IEEE.
- [18] Mamdani, E. H. (1977). Application of fuzzy logic to approximate reasoning using linguistic synthesis. *Computers, IEEE Transactions on*, 100(12), 1182-1191.
- [19] Yun, S., Lee, J., Chung, W., Kim, E., & Kim, S. (2009). A soft computing approach to localization in wireless sensor networks. *Expert Systems with Applications*, 36(4), 7552-7561.
- [20] Kumar, A., & Kumar, V. (2013, May). Fuzzy Logic Based Improved Range Free Localization for Wireless Sensor Networks. In *Proceedings of World Academy of Science, Engineering and Technology* (No. 77, p. 534). World Academy of Science, Engineering and Technology (WASET).
- [21] Chen, H., Shi, Q., Tan, R., Poor, H. V., & Sezaki, K. (2010). Mobile element assisted cooperative localization for wireless sensor networks with obstacles. *Wireless Communications, IEEE Transactions on*, 9(3), 956-963
- [22] Rosário, D., Costa, R., Paraense, H., Machado, K., Cerqueira, E., Braun, T., & Zhao, Z. (2012). A hierarchical multi-hop multimedia routing protocol for wireless multimedia sensor networks. *Network Protocols and Algorithms*, 4(4), 44-64.
- [23] Yang Yu and Viktor K. Prasanna, Energy-Efficient Multi-Hop Packet Transmission using Modulation Scaling in Wireless Sensor Networks, in *IEE GlobCom, DEC., 2003*
- [24] Mao, S., Zhao, C., Zhou, Z., & Ye, Y. (2013). An improved fuzzy unequal clustering algorithm for wireless sensor network. *Mobile Networks and Applications*, 18(2), 206-214.
- [25] Gupta, I., Riordan, D., & Sampalli, S. (2005, May). Cluster-head election using fuzzy logic for wireless sensor networks. In *Communication Networks and Services Research Conference, 2005. Proceedings of the 3rd Annual* (pp. 255-260). IEEE.
- [26] Kim, J. M., Park, S. H., Han, Y. J., & Chung, T. M. (2008, February). CHEF: cluster head election mechanism using fuzzy logic in wireless sensor networks. In *Advanced communication technology, 2008. ICACT 2008. 10th international conference on* (Vol. 1, pp. 654-659). IEEE.
- [27] Ran, G., Zhang, H., & Gong, S. (2010). Improving on LEACH protocol of wireless sensor networks using fuzzy logic. *Journal of Information & Computational Science*, 7(3), 767-775.
- [28] <http://www.dma.fi.upm.es>.
- [29] Kumar, V., Kumar, A., & Soni, S. (2011) A New Fuzzy Based Localization Error Minimization Approach with Optimized Beacon Range. In *IJCA Proceedings on International Conference and workshop on Emerging Trends in Technology (ICWET)* (pp. 52-59).
- [30] Kumar, A., & Kumar, V. (2013, May). Fuzzy Logic Based Improved Range Free Localization for Wireless Sensor Networks. In *Proceedings of World Academy of Science, Engineering and Technology* (No. 77, p. 534). World Academy of Science, Engineering and Technology (WASET).

- [31] Rosário, D., Costa, R., Paraense, H., Machado, K., Cerqueira, E., Braun, T., & Zhao, Z. (2012). A hierarchical multi-hop multimedia routing protocol for wireless multimedia sensor networks. *Network Protocols and Algorithms*, 4(4), 44-64..
- [32]]Huang, W. W., Peng, Y. L., Wen, J., & Yu, M. (2009, April). Energy-efficient multi-hop hierarchical routing protocol for wireless sensor networks. In *Networks Security, Wireless Communications and Trusted Computing, 2009. NSWCTC'09. International Conference on* (Vol. 2, pp. 469-472). IEEE.
- [33] W. Heinzelman, A. Chandrakasan, and H. Balakrishnan, "An application-specific protocol architecture for wireless microsensor networks", in *IEEE Transactions on Wireless Communications*, 1(4), pp. 660-670, Oct2002.
- [34] Ran, H. Z."Improving on LEACH Protocol of Wireless Sensor Networks Using Fuzzy Logic," *Journal of Information & Computational Science*, vol.7(3), pp. 767-775, 2010.
- [35] Boulanouar, I., Rachedi, A., Lohier, S., & Roussel, G. (2011, October). Energy-aware object tracking algorithm using heterogeneous wireless sensor networks. In *Wireless Days (WD), 2011 IFIP* (pp. 1-6). IEEE.
- [36] Hamdoun, S., Rachedi, A., & Benslimane, A. (2015). RSSI-based localisation algorithms using spatial diversity in wireless sensor networks. *International Journal of Ad Hoc and Ubiquitous Computing*, 19(3-4), 157-167.
- [37] Tlili, F., Rachedi, A., & Benslimane, A. (2014, June). Time-bounded localization algorithm based on distributed multidimensional scaling for wireless sensor networks. In *Communications (ICC), 2014 IEEE International Conference on* (pp. 233-238). IEEE.
- [38] Bradai, A., Singh, K., Rachedi, A., & Ahmed, T. (2015). EMCOS: Energy-efficient mechanism for multimedia streaming over cognitive radio sensor networks. *Pervasive and Mobile Computing*, 22, 16-32.
- [39] Kumar, S., & Lobiyal, D. K. (2014). Power efficient range-free localization algorithm for wireless sensor networks. *Wireless Networks*, 20(4), 681-694.
- [40] Kumar, S., & Lobiyal, D. K. (2017). Novel DV-Hop localization algorithm for wireless sensor networks. *Telecommunication Systems*, 64(3), 509-524.
- [41] Kumar, S., & Lobiyal, D. K. (2013). An advanced DV-Hop localization algorithm for wireless sensor networks. *Wireless personal communications*, 1-21.
- [42] Wang, C., Xing, L., Vokkarane, V. M., & Sun, Y. L. (2016). Infrastructure communication sensitivity analysis of wireless sensor networks. *Quality and Reliability Engineering International*, 32(2), 581-594.
- [43]]Colbourn, C. J., & Colbourn, C. J. (1987). *The combinatorics of network reliability* (Vol. 200). New York: Oxford University Press.
- [44] Zang, X., Sun, H., & Trivedi, K. S. (2000). A bdd-based algorithm for reliability graph analysis. Department of Electrical Engineering, Duke University, Tech. Rep.
- [45]]Shooman, M. L. (2001). *Reliability of computer systems and networks: Fault tolerance. Analysis, and Design*, Wiley-Interscience.
- [46] Bartlett, L. M., & Du, S. (2005). New progressive variable ordering for binary decision diagram analysis of fault trees. *Quality and Reliability Engineering International*, 21(4), 413-425.
- [47]]Huang, H. Z., Zhang, H., & Li, Y. (2012). A new ordering method of basic events in fault tree analysis. *Quality and Reliability Engineering International*, 28(3), 297-305.
- [48] Rausand, M., & Arnljot, H. (2004). *System reliability theory: models, statistical methods, and applications*(Vol. 396). John Wiley & Sons.

- [49] Meng, F. C. (2009). On some structural importance of system components. *Journal of Data Science*, 7(2-P), 277-283.
- [50] Birnbaum, Z. W. (1968). On the importance of different components in a multicomponent system(No. TR-54). Washington Univ Seattle Lab of Statistical Research.
- [51] Chang, Y. R., Lin, H. Y., Chen, Y., & Kuo, S. Y. (2003, November). A cut-based algorithm for reliability analysis of terminal-pair network using OBDD. In *Computer Software and Applications Conference, 2003. COMPSAC 2003. Proceedings. 27th Annual International* (pp. 368-373). IEEE.
- [52] H. Deldari, M. A. (2006). Fuzzy Algorithm for Scheduling Periodic Tasks on Multiprocessor". *IJCSN International Journal of Computer Science and Network Security*, Vol.6 No.3A.
- [53] M. Blej and M.Azizi. (2016). Task Parameters Managing and System Accuracy in Fuzzy Real Time Scheduling. *international journal of engineering sciences & research technology*. ISSN: 2277-9655.
- [54] L.X. Wang. (1996). *A course in fuzzy systems and control*" Prentice Hall, Paperback
- [55] Mamdani et al. (1975). An experiment in linguistic synthesis with a fuzzy logic controller. *International Journal of Man-Machine Studies*, Vol. 7, No. 1, pp. 1- 13.
- [56] M. Sugeno. (1985). *Industrial applications of fuzzy control*. Elsevier Science Inc. New York, NY.
- [57] Kavita Jain, Abhisek Soni (2015). Comparison of Mamdani and Sugeno Fuzzy Inference System for Deciding the Set Point for a Hydro Power Plant Dam Reservoir Based on Power Generation Requirement. *International Journal of Engineering, Management & Sciences*, ISSN: 2348 –3733, Vol-2, Issue-2.
- [58] Arshdeep Kaur, Amrit Kaur (2012). Comparison of Mamdani-Type and Sugeno-Type Fuzzy Inference Systems for Air Conditioning System. *International Journal of Soft Computing and Engineering (IJSCE)*, ISSN: 2231-2307, Vol-2, Issue-2.
- [59] M. Sabeghi M, Koen Bertels and Mahmoud Naghibzadeh (2007). Deadline vs. Laxity as a Decision Parameter in Fuzzy Real-Time Scheduling". *Proceeding Delft University of Technology Netherlands*.
- [60] Bailey, M. P., & Kulkarni, V. G. (1986). A recursive algorithm for computing exact reliability measures. *IEEE transactions on reliability*, 35(1), 36-40.