



HAL
open science

The role of microcrystalline structure on the temperature-dependent thermo-optical properties of semi-crystalline thermoplastics and non-invasive temperature measurements

Sinan Boztepe, Rémi Gilblas, Olivier de Almeida, Fabrice Schmidt, Yannick Le Maoult

► To cite this version:

Sinan Boztepe, Rémi Gilblas, Olivier de Almeida, Fabrice Schmidt, Yannick Le Maoult. The role of microcrystalline structure on the temperature-dependent thermo-optical properties of semi-crystalline thermoplastics and non-invasive temperature measurements. SFT 2017 - Congrès annuel de la Société Française de Thermique, May 2017, Marseille, France. hal-01617169

HAL Id: hal-01617169

<https://hal.science/hal-01617169>

Submitted on 6 Mar 2019

HAL is a multi-disciplinary open access archive for the deposit and dissemination of scientific research documents, whether they are published or not. The documents may come from teaching and research institutions in France or abroad, or from public or private research centers.

L'archive ouverte pluridisciplinaire **HAL**, est destinée au dépôt et à la diffusion de documents scientifiques de niveau recherche, publiés ou non, émanant des établissements d'enseignement et de recherche français ou étrangers, des laboratoires publics ou privés.

The role of microcrystalline structure on the temperature-dependent thermo-optical properties of semi-crystalline thermoplastics and non-invasive temperature measurements

Sinan BOZTEPE¹, Remi GILBLAS¹, Olivier de ALMEIDA¹, Fabrice SCHMIDT¹, Yannick Le MAOULT^{1*}

¹Université de Toulouse ; Mines Albi, ICA (Institut Clément Ader) ; Campus Jarlard, F-81013 Albi cedex 09, France

* (auteur correspondant : sboztepe@mines-albi.fr)

Résumé - The relation between the microcrystalline structure of unfilled semi-crystalline polyolefin (PO)-based polymer and its thermo-optical characteristics was studied under room and varying temperatures. The temperature-dependence of its optical properties was observed in NIR range while this effect vanishes after certain wavelengths in MIR range. This is critical in order to determine a methodology for an accurate non-invasive IR thermography on the polymer surface. The preliminary IR thermographic analyses showed that accurate surface temperature measurements may not be simply performed on the PO-based polymers due their optical characteristics.

Nomenclature

D_p	Optical penetration depth, μm	Φ_λ	Radiative flux
T_λ	Transmittance	β_λ	Extinction coefficient, m^{-1}
R_λ	Reflectance	κ_λ	Absorption coefficient, m^{-1}
D_λ	Scattering coefficient, m^{-1}	$\bar{\kappa}(T)$	Integrated absorption coefficient, m^{-1}

1. Introduction

Infrared (IR) radiation heat transfer is widely used for thermoforming process of thermoplastic polymers and their composites. Thermoforming process involves heating and forming stages where preforms are heated prior to the forming. For thermoforming of unfilled semi-crystalline thermoplastics, the effect of their microcrystalline structure on the optical properties is the key to develop a successful predictive model for the IR-heating stage of thermoforming process. The key reason behind this is that the microcrystalline structure of semi-crystalline polymers introduces an optically heterogeneous medium where the radiation penetrated into such polymer changes its direction due to optical scattering. Previous studies in literature showed that there is a strong coupling between microstructure of semi-crystalline thermoplastics and their thermo-optical properties in near-infrared (NIR) spectral range [1]-[3] where also this relation may be negligible in middle-infrared (MIR) range [1], [2]. As semi-crystalline thermoplastics are thermoformed in semi-molten state, their microcrystalline structure may evolve under varying temperature and change the scatterer characteristics. The optical properties of unfilled semi-crystalline polymers was analyzed in [4] and its temperature-dependence was demonstrated. Therefore, this temperature-dependent relation may not be neglected both for building an accurate radiation heat transfer model and, for non-invasive IR thermographic temperature measurements for experimental validation of such a model. In order to obtain a reliable surface temperature measurement via IR thermography it is required to know the optical characteristics of a heated material and the operating spectral band of an IR camera. It is desired that the surface of a heated material to be measured has a spectral band where the material is opaque -with a very low (or theoretically zero) optical

penetration depth- and, an employed IR camera operates in the corresponding spectral band. As the optical characteristics of unfilled semi-crystalline thermoplastics are related to their microcrystalline structure extra attention is required on their optical characteristics when an IR thermography is applied under varying temperature.

In this study, the optical scattering phenomenon due to microcrystalline structure in semi-crystalline PO-based polymer was experimentally analyzed performing bi-directional and directional-hemispherical transmittance measurements at room temperature. The analyses showed that the optical scattering greatly affects the transmittance in NIR range whereas this effect vanishes in MIR range for the wavelengths greater than 6 μm . The temperature-dependence of its transmittance was studied in NIR range using an in-house developed device that is built combining a Fourier Transform Infrared (FT-IR) spectrometer and a heating stage. These analyses provided a guide to develop an experimental approach for quantitative IR thermography. The suitable spectrums for IR thermography were chosen based on the no-transmittance spectral bands of tested samples. In addition, the optical penetration depth of the polymer was analyzed in the corresponding spectral bands. It was found that the material has relatively high optical penetration depth (D_p) that introduces a challenging surface temperature measurement via IR thermography. For the preliminary IR thermographic analyses, an IR-camera with an optical filter was used and a calibration curve was established performing measurements on a blackbody source. A plate-like PO-based sample was heated using a thermofoil heater and the surface temperature of the sample was registered using a resistance thermometer -also called resistance temperature detector (RTD)-. The registered RTD measurements were compared to the ones obtained via the IR camera. The preliminary analyses showed that IR thermographic measurements may not be simply performed on the PO-based polymers and require a correction method due to their semi-transparency.

2. Microcrystalline structure and optical scattering relations in unfilled semi-crystalline PO-based polymer

The optical scattering phenomenon in the PO-based polymer was experimentally analyzed performing transmittance measurements over the spectrums of NIR (0.8-2 μm) and MIR (2-25 μm). Polymer samples with different thicknesses were prepared using identical processing conditions and two different transmittance (T_λ) measurements were done on each sample employing a FT-IR spectrometer (Bruker Vertex 70) and an integrating sphere. The physical meaning of T_λ is the ratio of the total amount of transmitted (Φ_λ^t) radiative flux over the incident flux (Φ_λ^i) [5] at which the Φ_λ^i is the initial photon flux emitted by the spectrometer.

In the case of analyzing an optically heterogeneous medium, the transmittance may only provide the directly-transmitted light named as directional-directional transmission or “in-line transmission” in literature [6]. Although some amount of small angle forward-scattered radiative flux may also be detected by the detector of the spectrometer it is assumed to be negligibly small. In addition, it may be taken into account that the scattered light inside of an optically heterogeneous medium may come back into the direction of the incident light in case of multiple internal scattering. In other words, the light propagated inside of the medium may be scattered multiple times due to the optical heterogeneity and some part of the scattered light may be back to the direction of the incident light and detected by the spectrometer which is called in radiation theory as “radiative energy gain due to in-scattering” [7]. However, determination of the multiple scattering phenomena may require an extensive experimental analysis and therefore the effect of multiple internal scattering was neglected that in the current study. Based on the adopted assumptions, the measurements performed using the spectrometer lead to have the bi-directional transmittance of the tested samples. In order to analyze the effect of optical scattering qualitatively, the identical samples were positioned at

the entrance port (Port-1) of the integrating sphere so that directional-hemispherical transmittance of the samples were also measured [8]. The experimental setups for the bi-directional and directional-hemispherical transmittance measurements are displayed in Figure 1(a) and (b) respectively. For the sake of simplicity, the bi-directional and the directional-hemispherical transmittance are named as $T_{\lambda\text{-directional}}$ and $T_{\lambda\text{-hemispherical}}$ respectively. It should also be noted that some amount of the radiative flux may also be back-scattered inside of the polymer and may not enter the integrating sphere [8]. It was therefore assumed that radiative flux detected by the detector in the integrating sphere is the combination of both the forward-scattered (Φ_{λ}^s) and the directly-transmitted light (Φ_{λ}^t).

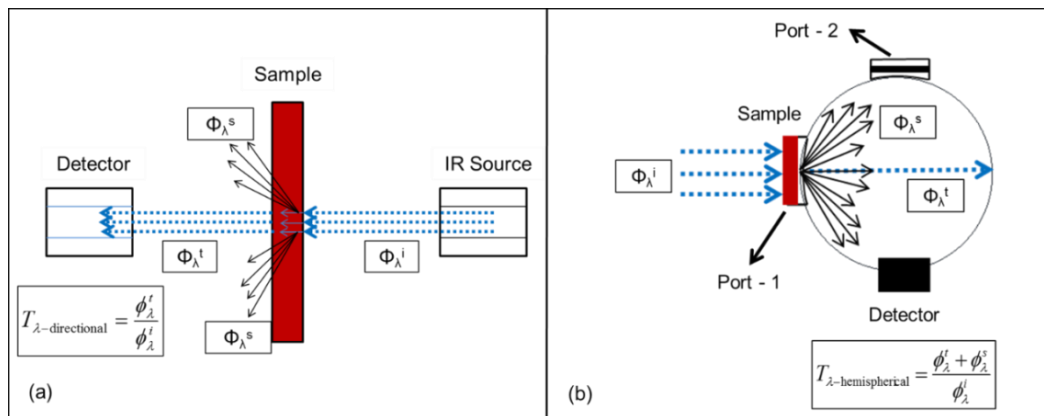

Figure 1: The experimental test set-ups for the bi-directional and directional-hemispherical transmittance measurements of the polymer using FT-IR spectrometer (a) and integrating sphere (b)

The $T_{\lambda\text{-directional}}$ and $T_{\lambda\text{-hemispherical}}$ measurements were performed using the identical samples that were prepared using an identical processing conditions, but with different thicknesses (0.42, and 1.82 mm). Thanks to the analyses, two different transmittance values were obtained on each sample and the information about the scattering characteristics of the PO-polymer medium was qualitatively analyzed. In Figure 2, the $T_{\lambda\text{-directional}}$ and $T_{\lambda\text{-hemispherical}}$ of the prepared samples are displayed in NIR (a) and MIR (b) ranges. As illustrated in Figure 2 (a), considering the spectral band around 1-1.2 μm the difference between the two measurements are around 60% and 40% for the 0.42 and 1.82 mm thick samples respectively. The difference in transmittance in the spectral range of 1-1.2 μm is crucial for IR-heating radiation models as the maximum emission wavelength of a typical IR lamp is in the corresponding range. In MIR range, the differences between the measurements on the identical samples are around 20% for the wavelengths lower than 3.5 μm where after the difference gradually decreases and becomes negligibly small for the wavelengths higher than 6 μm . A similar trend was reported in [1] for polypropylene where it was concluded that the effect of microcrystalline morphology becomes negligible considering an increase for the wavelengths in MIR range.

As also seen in Figure 2 (b), there are three narrow spectral bands around 3.4, 7.6 and 13.6 μm where the 0.42 and 1.82 mm thick PO-based samples have no transmittance. Regarding whole the spectrum analyzed in NIR and MIR ranges, it can be stated that the polymer is highly semi-transparent. The spectral band around 3.4 μm is known to be as carbon-hydrogen (C-H) absorption band causing to have zero transmission as reported for PO-based polymers [9]. In order to do an IR thermographic measurement on the PO-based polymer under varying temperature this spectral range may not be the best to operate an IR thermal camera. Because the microcrystalline structure of a semi-crystalline thermoplastics may evolve under varying temperature and therefore change the optical characteristics which may eventually affect the accuracy of IR thermographic measurements. Hence, the most accurate IR thermography of the PO-based polymer may not be obtained for the spectrum lower than 6 μm . In addition, directional-hemispherical reflectance ($R_{\lambda\text{-hemispherical}}$) measurements were done at room

temperature and $R_{\lambda\text{-hemispherical}}$ was found out around 7% considering the whole MIR range where the difference between $R_{\lambda\text{-hemispherical}}$ of the samples was negligibly small.

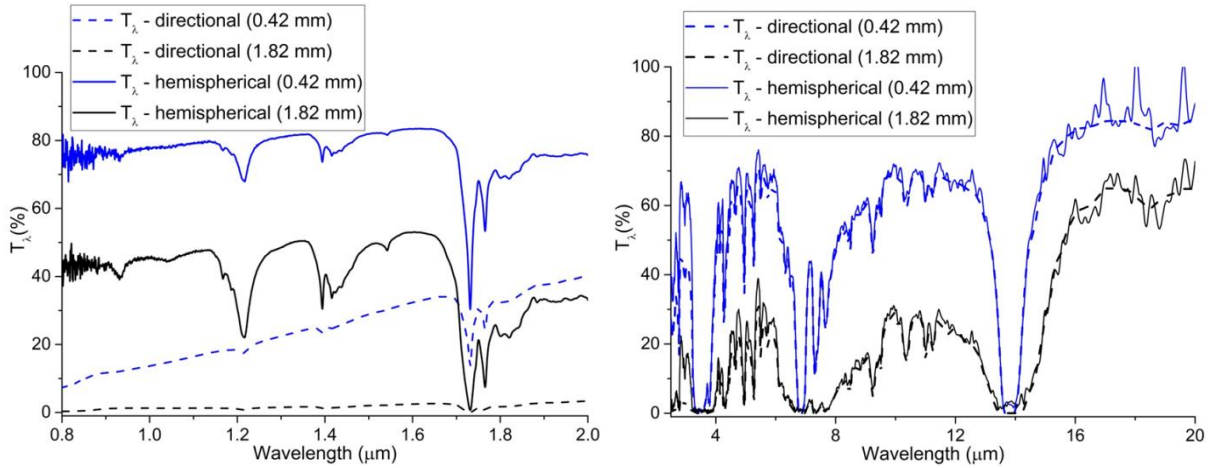

Figure 2: $T_{\lambda\text{-directional}}$ and $T_{\lambda\text{-hemispherical}}$ of the identical samples in NIR (a) and MIR ranges (b).

3. Temperature-dependent optical properties of unfilled semi crystalline thermoplastics

Transmittance of the PO-based polymer was experimentally analyzed under heating conditions using an in-house developed test set-up. For the tests, a heating stage (Bruker A599) was mounted in the FT-IR spectrometer and the sample was positioned inside of the heating stage (Figure 3). $T_{\lambda\text{-directional}}$ of the polymer was measured at discrete temperature points where the polymer was heated up to a set temperature (T_{set}) and waited for 2 minutes at each measurement point in order to sustain a constant temperature during the measurements. It was observed that the temperature in the measurement zone (T_{middle}) of the polymer was different than the T_{set} due to convection cooling on its surface. The variation is critical in order to determine the size of the measurement zone since the temperature variation should be negligible so that a reliable correlation between the actual measured temperature and the transmittance can be obtained. Therefore, before doing the temperature-dependent transmittance measurements, the variation between T_{set} and T_{middle} was analyzed using a PET polymer sample prepared with the identical thickness at which its surface temperature was monitored using an IR camera. PET was chosen as a reference material as it is opaque in the operating range of a typical IR camera thus, a reliable surface temperature can be obtained [10]. It was considered that the T_{middle} of the PO-based polymer is identical to the PET based on the (simplifying) assumption that conduction heat transfer and convection cooling is the same for both the polymers. Based on the analyses, the beam width of the Φ_{λ}^i that is sourced from the spectrometer was set to 1.5 mm as the temperature variation in the measurement zone is 0.3 °C. The details of this correction method can be found in [11].

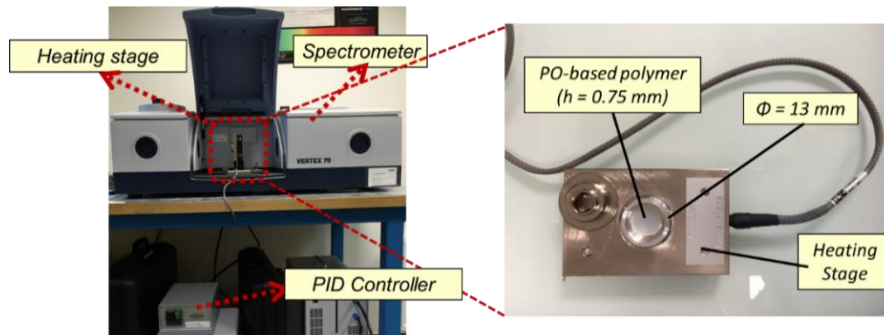

Figure 3: The test set-up for temperature-dependent bi-directional transmittance measurements

The $T_{\lambda\text{-directional}}$ of the sample were measured for the temperature range between room temperature up to 125 °C. The temperature presented here reflects T_{middle} which is the temperature where the $T_{\lambda\text{-directional}}$ measurements were obtained. The changes in the transmittance between 25 °C and 83 °C was less than 1% and therefore they are not presented in Figure 4 for the sake of simplicity. As displayed in Figure 4, $T_{\lambda\text{-directional}}$ of the polymer changes dramatically after 114 °C and surpasses its $T_{\lambda\text{-hemispherical}}$ value after 120 °C. The changes in the color of the polymer can also be seen clearly where the polymer has a milky color at lower temperatures and becomes totally transparent after 120 °C. Such a change in its color is indeed due to optical scattering - which is also called haze in literature-. A typical IR lamp for thermoforming processes has a temperature around 2400 K so that 96% of its emitted energy is between 0.6 and 6 μm which becomes crucial for IR heating of such type of semi-crystalline polymers. It should also be mentioned that $T_{\lambda\text{-directional}}$ measurements under heating in MIR range showed there is no significant change with temperature where the effect of microcrystalline structure may be negligible, as similarly observed at room temperature.

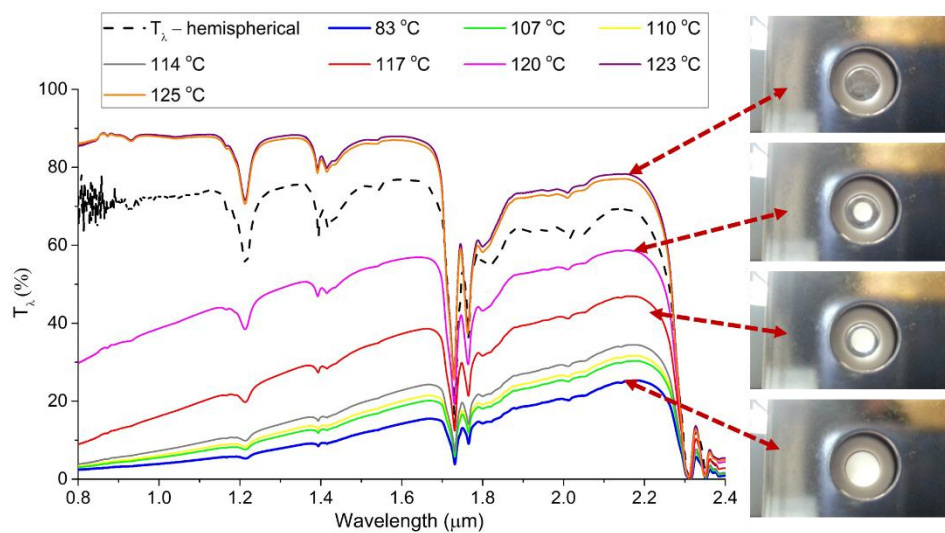

Figure 4: Temperature dependence of the bi-directional transmittance (solid lines) and its comparison to the directional-hemispherical (dashed line) obtained at room temperature

4. IR thermography of PO-based polymer

4.1. The semi-transparency and the optical penetration depth of the PO-based polymer

As aforementioned, the microcrystalline structure does not affect the transmittance properties of the PO-based polymer for the wavelengths greater than 6 μm . Hence, the most accurate IR thermographic measurements may be obtained in the spectral bands around 7.6 and 13.6 μm where the transmittance is zero. In addition, a typical IR camera has an operating spectral range between 7-14 μm [12] that covers these two spectral bands and therefore makes them the most suitable bands. However, these no-transmittance bands are relatively narrow in comparison to the operating range of a typical IR camera. Therefore a tailored optical filter is necessary for quantitative IR thermographic measurements. The term -tailored- is used here to define the specific bandwidth where an IR-camera captures photons only in preferably selected wavelengths thanks to an optical filter mounted on the camera.

At very first step of the study, both the spectral ranges around 7.6 and 13.6 μm were analyzed where two different optical filters were used for the IR thermography. The optical filters have spectral ranges around 7.6 μm and 13.6 μm , with bandwidths of $\pm 0.10 \mu\text{m}$ and $\pm 0.21 \mu\text{m}$ respectively. The initial analyses showed that the sensitivity of the employed IR-camera around 13.6 μm was too low. Therefore, the optical filter with a spectral range around

7.6 μm and with a bandwidth of $\pm 0.10 \mu\text{m}$ was chosen. The D_p of the polymer was calculated considering the chosen spectral band. Since its microcrystalline structure has no effect on its optical characteristics in the chosen band homogeneous medium can be assumed:

$$\beta_\lambda = \kappa_\lambda + D_\lambda \quad \text{where; } D_\lambda = 0; \quad (1)$$

The integrated absorption coefficient -which is reciprocal of D_p - was calculated based on the transmittance of the PO-based polymer in the corresponding spectral band and at the temperature ($T = 373 \text{ K}$) close to its thermoforming process temperature. The D_p of the polymer was found around $350 \mu\text{m}$ indicating that the absorbed and therefore emitted radiation may not be considered on the surface of the polymer but, in a range close to surface which may require a correction method on the IR thermographic analyses.

$$\bar{\kappa}(T = 373\text{K}) = \frac{\int_{\lambda_1=7.5\mu\text{m}}^{\lambda_2=7.7\mu\text{m}} \kappa_\lambda \cdot I_\lambda^o(T_{373\text{K}}) d\lambda}{\int_{\lambda_1=7.5\mu\text{m}}^{\lambda_2=7.7\mu\text{m}} I_\lambda^o(T_{373\text{K}}) d\lambda} \quad \text{with; } D_p = \frac{1}{\bar{\kappa}(T = 373 \text{ K})} \quad (2)$$

4.2. IR-Camera Calibration and the Test-up for IR Thermographic Analyses

For the IR thermographic measurements a cooled long-wave (LW) IR-camera (AGEMA 880) was employed and the chosen narrow-band optical filter (Northumbria Optical Coatings) was mounted on the IR-camera. Before doing IR-thermographic analyses with the employed LW IR-camera, the optical filter was also mounted on an uncooled microbolometric IR-camera (FLIR SC325) and tested however enough sensitivity could not be obtained. The typical operating spectral range of the employed LW IR-camera is between 8 and 12 μm indicating that spectral sensitivity of the IR camera detector is nominal in this range, whereas the detector is still sensitive at the wavelengths beyond, but close to, this range. In the current study, it was found out that the LW IR camera is still sensitive enough for the measurements in the spectral band around $7.6\mu\text{m}$, however an extra step was required to be applied to adjust the sensitivity of the camera. A blackbody calibration source (Landcal P550P) was used for establishing a correlation between the IR radiation captured by the camera and a surface temperature to be measured. The calibration was done choosing reference temperatures on the blackbody source between 60 and 120 $^\circ\text{C}$ and the radiometric value (UI) detected by the camera was registered for each corresponding reference temperature. Thus, a calibration curve was established that enables to convert the detected energy emitted from the surface of the polymer to a temperature value. In Figure 5 and 6, the test set-up for the calibration and the registered radiometric values in the chosen reference temperatures are displayed respectively.

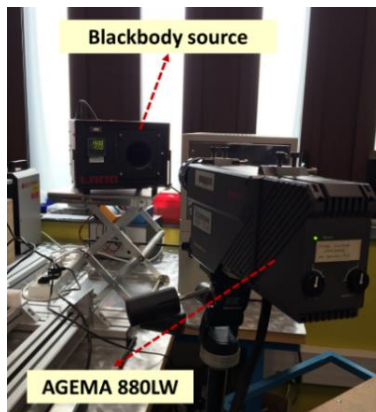

Figure 5: Test set-up for calibration of IR camera with the optical filter at $7.6 \mu\text{m}$

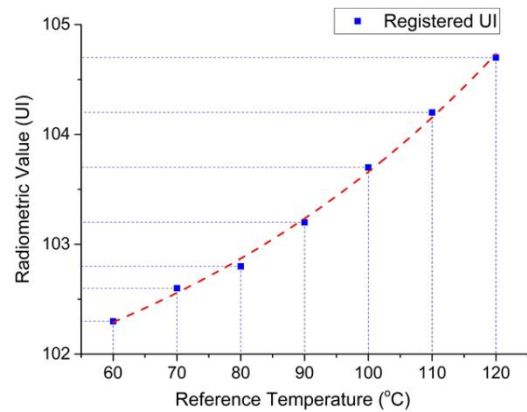

Figure 6: The calibration curve (dashed line) obtained for the chosen reference temperatures

Thanks to the calibration curve, a preliminary IR thermographic analysis was done on the polymer. For the analysis, a plate-like polymer sample was prepared and heated by conduction using an electric thermofoil heater (Minco). A copper foil was embedded between the heater and the sample for performing a uniform heat transfer throughout the sample. The contact between all the components was secured using a clamp on each side. In addition, black coating was applied on the two small zones of the sample surface with the aim of creating a reference measurement zone. The emissivity of the black coating is 0.9 which was previously determined in our laboratory. The surface temperature measurements on the PO-based polymer were performed between 60 and 80°C where the measurements were registered at each 5°C increment via both the RTD and the IR camera. Thus, five measurements were obtained in the chosen temperature range. The energy detected by the IR camera was converted into temperature using the calibration curve and the registered IR thermographs of the polymer were compared to the RTD measurements that were obtained at each corresponding measurement point. In Figure 7, the test set-up for heating the PO-based sample (a), a thermographic image of the sample registered under heating (b) and the recorded temperature values that were obtained via the RTD and the IR-camera at each measurement point (c) are presented. As displayed in Figure 7 (b), a comparison zone was defined on the bare polymer surface and, the same zone was analyzed on each obtained IR-thermographic image to compare them with the RTD measurements. This comparison zone was chosen close to the area where the RTD is mounted on the sample surface. The comparisons between both the measurements showed that error in the recorded values is less than 1% for the measurements obtained at 60 and 65°C whereafter the temperature read by the IR-camera shows higher value than the RTD measurements at higher temperatures and the error reaches up to 17.5% at which the difference in the measured temperatures is 15°C. The reason behind this may be twofold: The temperature measurement obtained via RTD may be erroneous at higher temperatures due to the polymer softening, as it may change the contact quality between the RTD and the sample and, eventually RTD may read lower values than the IR-camera. Also, thermal resistance alongside the metallic wires of the RTD may affect the measured temperature at which the heat losses increase proportionally with temperature. These preliminary analyses revealed that RTD may not be fully reliable to make comparison and establish a correction methodology. Therefore the accurate comparisons may be only obtained between the IR thermographs and the reference measurement zone created using black coating, which is the future work of this study.

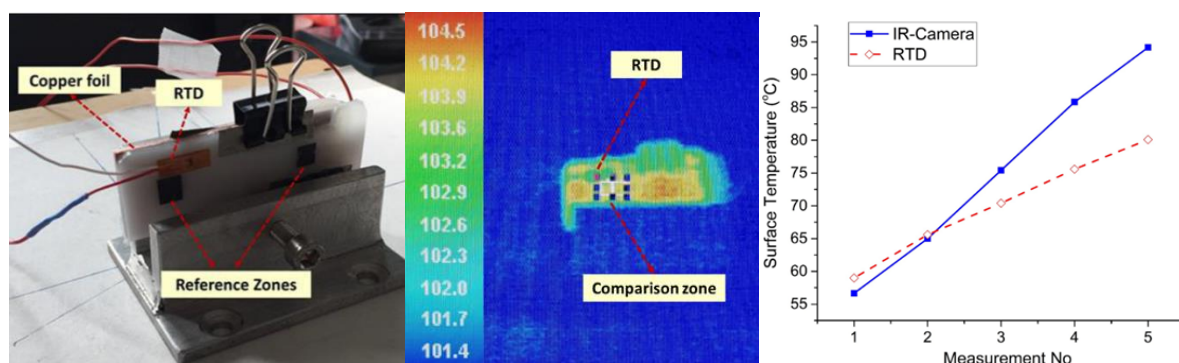

Figure 7: Test set-up for heating the PO-based polymer (a), its IR thermography at 75 °C (b) and the comparison between the surface temperatures measured via the RTD and the IR-camera (c)

5. CONCLUSIONS

The IR thermography of PO-based polymer was analyzed and its optical properties were evaluated in terms of bi-directional and directional-hemispherical transmittance measurements under room and varying temperatures. The effect of its microcrystalline structure on the optical

properties was experimentally analyzed and it was found that the optical scattering greatly affects the transmittance in NIR range whereas this effect becomes negligible in MIR range, for the wavelengths greater than 6 μm . Bi-directional transmittance measurements obtained in NIR range and under varying temperature demonstrated the temperature dependence of its optical properties due to evolution in its microcrystalline structure under heating.

These analyses provided a guide to develop an experimental approach for the IR thermography of the PO-based polymer. After the initial analyses with the employed IR-camera, the optical filter with a spectral range around 7.6 μm and with a bandwidth of ± 0.10 μm was chosen for the IR-thermographic analyses. A preliminary IR thermographic analysis was performed on the PO-based polymer and its surface temperature was also registered using a RTD at which those measurements were compared to the ones obtained through the IR camera. The preliminary analyses demonstrated that quantitative IR thermography on the PO-polymer may only be obtained after a correction methodology is applied adopting a comparative analysis between IR thermographs of the bare polymer surface and the reference measurement zone created using a black coating, as D_p of the polymer introduces a challenging step in terms of emitted energy by its surface.

Références

- [1] D. Hakoume, L. A. Dombrovsky, D. Delaunay, and B. Rousseau, "Effect of Processing Temperature on Radiative Properties of Polypropylene and Heat Transfer in the Pure and Glassfibre Reinforced Polymer," Proceedings of 15th IHTC, (2014).
- [2] S. Boztepe, A. Thiam, O. de Almeida, Y. Le Maout, and F. Schmidt, "Experimental analysis on the coupled effect between thermo-optical properties and microstructure of semi-crystalline thermoplastics," Proceedings of 19th ESAFORM Conference, (2016).
- [3] A. Denis, E. Dargent, P. H. Lebaudy, J. Grenet, and C. Vautier, "Dependence on the spectral scattering coefficient on crystallinity into semicrystalline polyester," *J. Appl. Polym. Sci.*, 62-8, (1996), 1211-1218.
- [4] M. Geiger, T. Frick, and M. Schmidt, "Optical properties of plastics and their role for the modelling of the laser transmission welding process," *Prod. Eng.*, 3-1, (2009), 49-55.
- [5] E. F. Zalewski, "Radiometry and photometry," in *Handbook of Optics*, vol. 2, (1995).
- [6] R. Apetz and M. P. B. van Bruggen, "Transparent Alumina: A Light-Scattering Model," *J. Am. Ceram. Soc.*, 86-3 (2003), 480-486.
- [7] J. R. Howell, M. P. Menguc, and R. Siegel, *Thermal Radiation Heat Transfer, 5th Edition*, 5 edition. Boca Raton: CRC Press, (2010).
- [8] J. Manara, M. Arduini-Schuster, and L. Hanssen, "Integrating sphere reflectance and transmittance intercomparison measurements for evaluating the accuracies of the achieved results," *High Temp-High Press*, 38, (2009), 259-276.
- [9] D. P. DeWitt and G. D. Nutter, *Theory and Practice of Radiation Thermometry*. John Wiley & Sons, (1988).
- [10] S. Monteix, Y. L. Maout, F. Schmidt, and J. P. Arcens, "Quantitative infrared thermography applied to blow moulding process: measurement of a heat transfer coefficient," *Quant. InfraRed Thermogr. J.*, 1- 2, (2004), 133-150.
- [11] S. Boztepe, O. de Almeida, Y. Le Maout, and F. Schmidt, "Identification of the temperature dependent relation between thermo-optical properties and morphology of semi-crystalline thermoplastics for thermoforming process," presented at the Proceedings of the 32th International PPS Conference, Lyon - France, (2016).
- [12] Y. Le Maout and F. Schmidt, "Infrared Radiation Applied to Polymer Processes," in *Heat Transfer in Polymer Composite Materials*, N. Boyard, Ed. John Wiley & Sons, Inc., 2016, 385-423.