



HAL
open science

Determination of Stresses in Drying Wood by Means of a Viscoelastic Relaxation Model

Omar Saifouni, Rostand Moutou Pitti, Jean-François Destrebecq

► **To cite this version:**

Omar Saifouni, Rostand Moutou Pitti, Jean-François Destrebecq. Determination of Stresses in Drying Wood by Means of a Viscoelastic Relaxation Model. Challenges in Mechanics of Time-Dependent Materials and Processes in Conventional and Multifunctional Materials, Proceedings of the 2012 Annual Conference on Experimental and Applied Mechanics, 2, pp.29 - 36, 2013, 10.1007/978-1-4614-4241-7_5 . hal-01616935

HAL Id: hal-01616935

<https://hal.science/hal-01616935v1>

Submitted on 17 Oct 2017

HAL is a multi-disciplinary open access archive for the deposit and dissemination of scientific research documents, whether they are published or not. The documents may come from teaching and research institutions in France or abroad, or from public or private research centers.

L'archive ouverte pluridisciplinaire **HAL**, est destinée au dépôt et à la diffusion de documents scientifiques de niveau recherche, publiés ou non, émanant des établissements d'enseignement et de recherche français ou étrangers, des laboratoires publics ou privés.

DETERMINATION OF STRESSES IN DRYING WOOD BY MEANS OF A VISCOELASTIC RELAXATION MODEL

Omar SAIFOUNI, Rostand MOUTOU PITTI, Jean-François DESTREBECQ

Clermont Université, Université Blaise Pascal, Institut Pascal, BP 10448,
F-63000 CLERMONT-FERRAND, France
CNRS, UMR 6602, Institut Pascal, F-63171 AUBIERE, France
rostand.moutou.pitti@polytech.univ-bpclermont.fr

ABSTRACT. Stress states caused in wood by drying periods are often the source of considerable structural disorders, when this material is used as structural material. The origin of these stresses is generally due to the viscoelastic behaviour of the wood combined with the dimensional variations (shrinkage) related to the moisture content. In order to better understand this phenomenon, a slice of green wood is submitted to natural drying in stable environmental conditions. The wood slice is placed on an electronic balance so as to measure the moisture content variation during the drying period. Simultaneously, the displacements caused in the slice by the drying are captured by a video camera. An incremental relaxation model based on the generalized Maxwell's chain is used to analyze the evolution of the stresses induced by the drying process within the wood slice. Numerical results show the development of tensile stresses in the material. Analyzing these results leads to the conclusion that the stresses are due to the orthotropic behaviour of the wood material combined with anisotropic drying shrinkage. A tensile stress concentration is evidenced in a zone where a crack was finally observed during the test.

1. Introduction

The natural or the artificial drying of wood is commonly responsible for large strain and can lead to the cracking and the final collapse of the timbers structures. These defects are much more marked on the wood pieces cut and stored outdoors the long periods ago [1]. The timber is composed of polymers sensitive to the temperature and the humidity, therefore, its drying involves dimensional changes due to the shrinkage. Hence, the behaviour of wood during drying depends strongly in the one part, of the geometry, the moisture content gradient, the temperature, the sorption of wood history, but also, of the heterogeneous character, the orthotropic behaviour, and the viscoelastic effects of this material. It appears that, the phenomenon of shrinkage and the mechanical behaviour of wood during drying play an important role in the development of wood defects. In this context, it is essential to understand the contribution of different processes in the strain of the green wood during the drying phase.

In the literature, various studies concerning the strain and the stress evolutions caused by drying of wood have been conducted. These works are generally based on complex analytical approaches solved by finite element models taking into account the changes of the mechanical properties of wood during the drying phase [2,3]. In addition, several authors have presented drying models that can assess the distribution of moisture inside the wood during the shrinkage with moisture content near the fiber saturation point (FSP) [4]. Also, the mechanical behaviour of wood and tree has been proposed in order to know the impact of the biomechanical and the microstructures parameters in the old history [5]. Recently, the studies on the rheological behaviour of wood during growth phases have shown the effect of the viscoelastic effects in the recovery of the tree during its growth [6] without insist on the contribution of moisture content in the manifestation of this complex phenomenon.

In this work, an incremental viscoelastic relaxation model adapted to orthotropic material taking into account the hygroscopic variations of wood during the drying process is developed. The analytical model is based on the Boltzmann integral equations that can be solved by an incremental formulation expressed in term of creep [7] or relaxation [8,9] approach. The first part describes the mechanism of drying stresses in wood and the experimental details considered in the numerical sample. Then, the incremental law applied to viscoelastic orthotropic material and the algorithm resolution implemented in the finite element code Cast3m, are detailed together. The numerical results, in terms of stress evolutions, with and without viscoelastic behaviour are compared and discussed.

2. Experimental technique

2.1 Wood drying mechanical behaviour and experimental setup

The objective of the drying process is to reduce the moisture content of wood avoiding in the same time the potential losses of quality caused by the different defects existing in the wood material [2]. For the wood species, it appears that above the fiber saturation point (FSP), the wood is not submitted to any dimensional changes. However, below the FSP until the anhydrous state, there is an almost linear relationship between moisture content and the dimensional changes [10]. The FSP rate is slightly variable and depends on the considered species. According to the cylindrical geometry of the tree, the circular path of the annual rings and the axial orientation of cells, an axisymmetric mechanical characteristics or cylindrical orthotropic material (longitudinal L , tangential T , and radial R directions) can be applied. In fact, the shrinkage is due to the dimensional changes during the variation of moisture content. Thus, each species is characterized by three coefficients of shrinkage (axial, radial and tangential shrinkages) that express the dimensional variations of a wood piece for a humidity change of 1% in the three directions mentioned above. The drying strains highly anisotropic and the axial shrinkage can be neglected compared with the tangential and the radial shrinkage [10]. However, for some species, the radial and tangential shrinkage are almost identical, consequently, these species are less sensitive to drying cracks.

The experimental setup is based on the mark tracking method consisting of an acquisition system date recording the displacement of target posted on the wood slice during the drying phase, Figure 1 (a). The diameter and thickness of the slice are about 10 cm and 2.5 cm respectively, and the environmental conditions of the room test are constant. Simultaneously, the sample is placed on an electronically balance providing the weight measure versus time, Figure 1 (b).

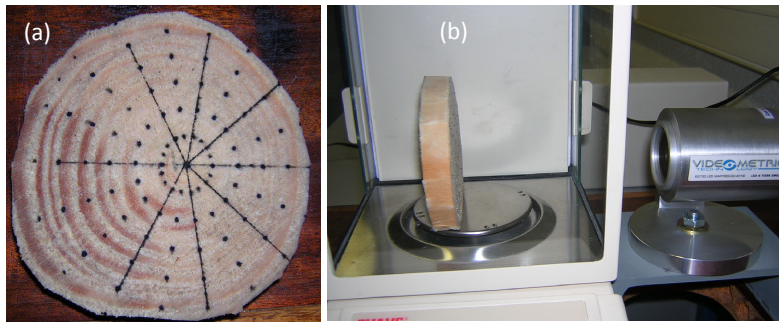

Figure 1 – (a) Green wood slice. (b) Experimental device.

2.2 Experimental results

Figure 2 shows the evolution of the moisture content versus time obtained for a slice of green wood subjected to natural drying.

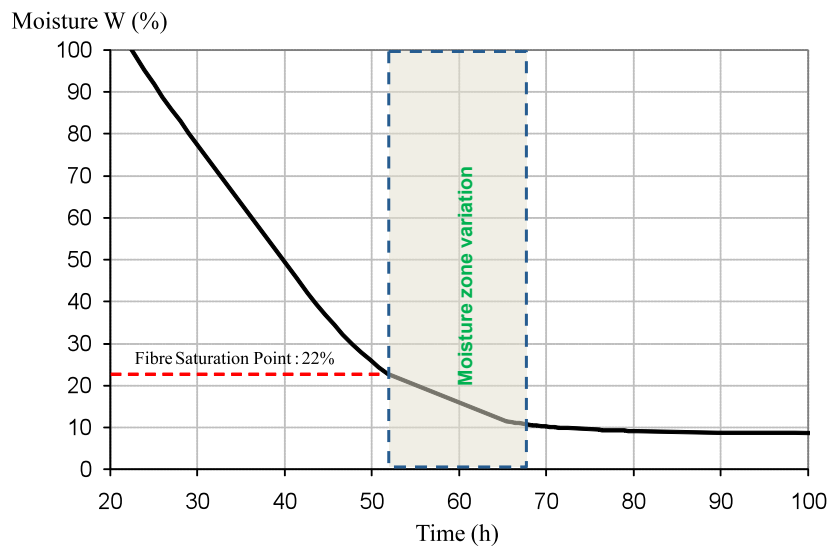

Figure 2 – Evolution of moisture versus time Computed [11].

The slice was placed on a high-sensitivity weigh whose values were recorded every two hours until the stabilization of the internal moisture around 11% for a FSP of about 22%. The range time of observed hygroscopic variation is 14h. According to the marked posted on the slice along the radius R_i , the displacements of the target 27 (see Figure 3 (a)) versus the moisture content are shown by Figure 3 (b). It observed also that, the PSF is about 22% due to the low variation of displacements.

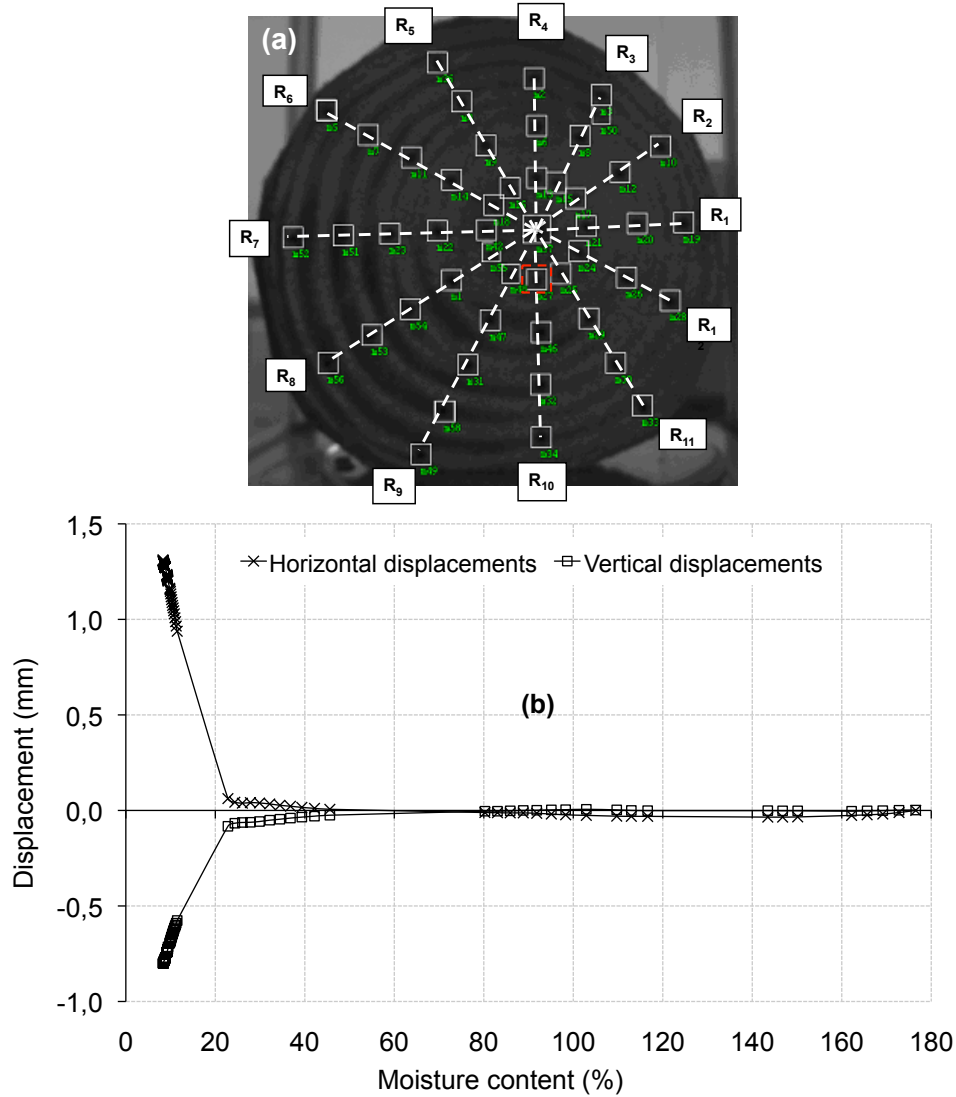

Figure 3 – (a) Target on wood slice. (b) Displacement evolutions versus moisture content.

3. Viscoelastic formulation and algorithm

3.1 Viscoelastic incremental approach

The behaviour of a viscoelastic solid material can be written in the course of time in the form of a Volterra's integral as follows: In the general orthotropic case, the viscoelastic relaxation matrix $[R(t, t_0)]$ depends on nine independent time functions t_0 (time loading application) and t (current time). This number is reduced to three in the one-dimensional case (plane stress or plane strain) if the creep or the relaxation takes place at constant Poisson's coefficient. According to the additional assumption that these quantities change proportionally to the same dimensionless relaxation function, the viscoelastic matrix relaxation is given by

$$[R(t, t_0)] = \rho(t, t_0)[K_0] \quad (1)$$

In this expression, $[K_0]$ is the orthotropic elastic stiffness matrix; $\rho(t, t_0)$ is a non-dimensional function that is expressed with a Dirichlet series (spectral representation equivalent to a generalized Maxwell model, Figure 4):

$$\rho(t, t_0) = \gamma_0 + \sum_{\mu=1}^r \gamma_{\mu} e^{-\epsilon_{\mu}(t-t_0)} \quad \text{with} \quad \sum_{\mu=0}^r \gamma_{\mu} = 1 \quad \text{and} \quad \rho(t, t_0) \in [1, \gamma_0[\quad (2)$$

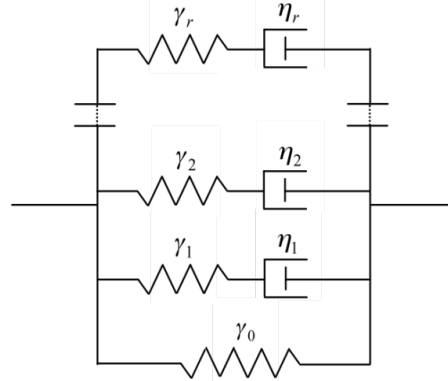

Figure 4 – Generalized Maxwell model.

The behaviour law of a viscoelastic material is given by the following Boltzmann constitutive equation written in the relaxation approach

$$\{\sigma(t)\} = [K_0] \int_0^t \rho(t, \tau) \{\dot{\epsilon}^m(\tau)\} d\tau \quad (3)$$

Considering that the total strain is given by

$$\{\epsilon(\tau)\} = \{\epsilon^m(\tau)\} + \{\epsilon^*(\tau)\} \quad (4)$$

where $\{\epsilon^m(\tau)\}$ is the origin mechanical strain, $\{\epsilon^*(\tau)\}$ is the non dependent free strain of the material stress state (drying moisture). According to the equation (3), the stress increment $\{\Delta\sigma\}$ for a finite time interval $[t, t + \Delta t]$ takes the following form:

$$\{\Delta\sigma\} = [K_0] \left(\int_t^{t+\Delta t} \rho(t + \Delta t, \tau) \{\dot{\epsilon}^m(\tau)\} d\tau + \int_0^t (\rho(t + \Delta t, \tau) - \rho(t, \tau)) \{\dot{\epsilon}^m(\tau)\} d\tau \right) \quad (5)$$

We suppose that the strain $\{\epsilon^m(\tau)\}$ can be approached by a linear form during the time finite interval $[t, t + \Delta t]$ as follow:

$$\{\epsilon^m(\tau)\} \cong \{\epsilon^m(t)\} + \frac{\tau - t}{\Delta t} \{\Delta\epsilon^m\} \quad \text{with} \quad \{\dot{\epsilon}^m(\tau)\} \cong \frac{\{\Delta\epsilon^m\}}{\Delta t} \quad (6)$$

Finally, introducing the equations (6) and (4) in the relation (5), the orthotropic linear viscoelastic law takes the form of an incremental matrix equation:

$$\{\Delta\sigma\} = [\tilde{K}] \{\Delta\epsilon\} + \{\sigma^{hist}(t)\} - \{\Delta\sigma^*\} \quad \forall t, \Delta t \quad (7)$$

with

$$[\tilde{K}] = \left(\gamma_0 + \sum_{\mu=1}^r \tilde{\gamma}_{\mu} \right) [K_0] = \left(\gamma_0 + \sum_{\mu=1}^r \gamma_{\mu} \frac{1 - e^{-\alpha_{\mu} \Delta t}}{\alpha_{\mu} \Delta t} \right) [K_0] \text{ and} \quad (8)$$

$$\{\sigma^{hist}(t)\} = \sum_{\mu=1}^r \{\sigma^{hist}_{\mu}(t)\} = - \sum_{\mu=1}^r (1 - e^{-\alpha_{\mu} \Delta t}) \{\sigma_{\mu}(t)\} \text{ et } \{\Delta\sigma^*\} = [\tilde{K}] \{\Delta\varepsilon^*\}$$

where $[\tilde{K}]$ is the fictitious rigidity matrix. $\{\sigma^{hist}(t)\}$ is the term history witch summary the past loading effects until the first loading on the actual response. These values depends of the parameters $\alpha_{\mu}, \gamma_{\mu}$ and of the time increment Δt ; it depends also of the internal variables witch must be actualized at the end of each increment calculation:

$$\{\sigma_{\mu}(t + \Delta t)\} = \{\sigma_{\mu}(t)\} + [\tilde{K}_{\mu}] (\{\Delta\varepsilon\} - \{\Delta\varepsilon^*\}) + \{\sigma_{\mu}^{hist}(t)\} \quad \forall \mu \in [1, r]: \quad (9)$$

The tensor $\{\Delta\varepsilon\}$ represents the strain increment for the step past time.

3.2 Finite element implementation

The proposed viscoelastic incremental model is implemented in the finite element software Cast3m following the routine presented in Figure 5.

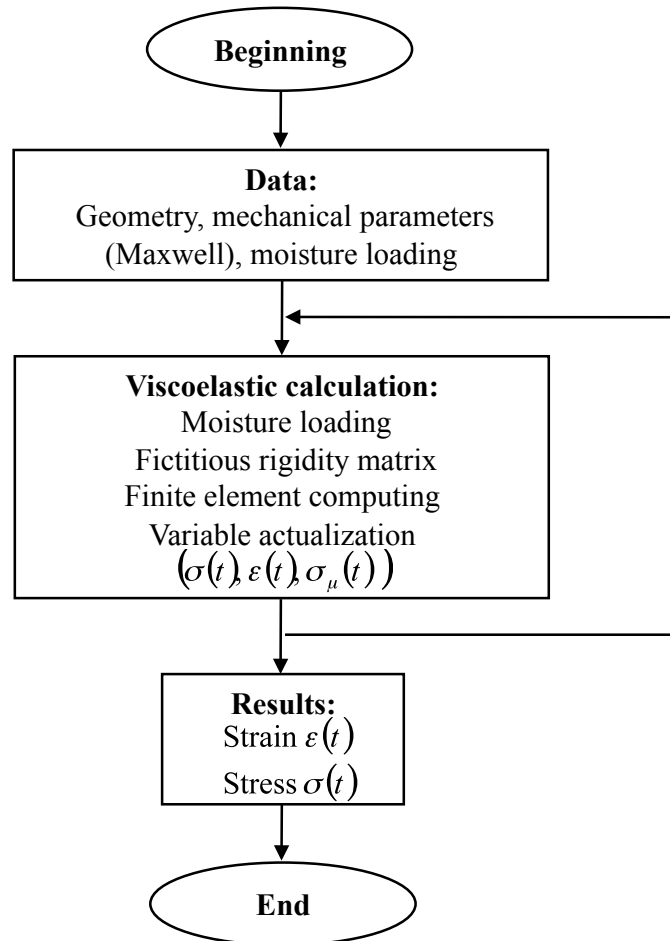

Figure 5 – Viscoelastic incremental routine.

Each step viscoelastic calculation begins by the evaluation of the fictitious rigidity matrix $[\tilde{K}]$ and the hereditary stress $\{\sigma^{hist}(t)\}$. After, the precedent data are considered in the solving of the equivalent thermoelastic problem according to equation (7). Finally, the internal stresses regarding equation (8) are actualized before the following step.

4. Numerical simulation and discussion

4.1 Wood slice viscoelastic parameters

The wood green slice (Douglas fir, see Figure 4) is modelled with the finite element software Cast3M. Considering the Small thickness, the plane stress hypothesis is considered. The hygroscopic boundary conditions are free and the vertical displacements are zeroed at the bottom of the specimen. The modelling is conducted on the basis of the incremental formulation presented in the section 3.1 by considering a Zener's model composed of two Maxwell's cells posted in Figure 4. The tree elastic moduli (E_r , E_t and G_{rt}), the Poisson's coefficient ν_{rt} , the radial and tangential shrinkage coefficients (α_r and α_t) and the parameters of the non-dimensional relaxation function $\rho(t_0, t)$ are presented in the following Table 1:

Table 1 – Parameters of the relaxation function.

E_r (GPa)	E_t (GPa)	G_{rt} (GPa)	ν_{rt}	α_r	α_t	γ_0	γ_1	α_1 (h ⁻¹)
1.125	0.730	0.096	0.3	0.17	0.31	0.75	0.25	0.5

4.2 Results and discussion

The numerical simulation shows the stress onset during the development shrinkage by the heterogeneity of wood due to the orthotropic character or the shrinkage process

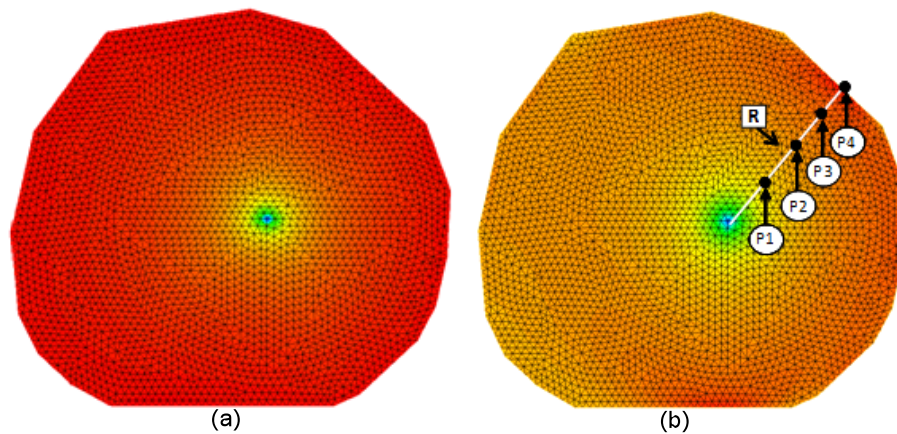

Figure 6 – Stress at the time t=14h. (a) Radial stresses. (b) Circumferential stresses.

The stress analysis shows that the slice is compressed almost everywhere in the radial direction Figure 6 (a). In the circumferential direction (Figure 6 (b)), the sign of the stresses changes: there are tensile stresses at the periphery and compression stresses when approaching the center. We note also the existence of two zones of circumferential traction concentration stresses due to the asymmetry of the slice. For the further, we study the evolution of circumferential stresses versus the radius noted R, which connects the center of the slice around P1 at the point P4, where the circumferential stress is maximal.

Figure 7 shows that the circumferential stresses occur in a self-balanced manner along the radius R, the compressed zone at the center balancing the tension zone at the periphery.

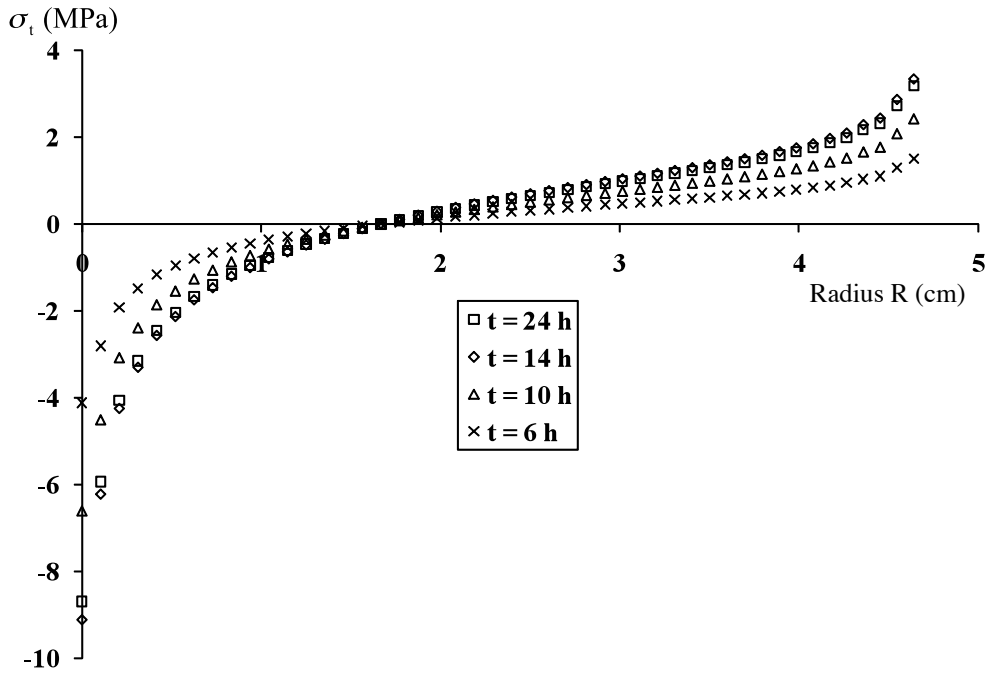

Figure 7 – Distribution of circumferential stresses along the radius R

Figure 8 shows the evolution of the circumferential stresses versus time for each point P1 to P4 in the case of elastic and viscoelastic behaviour. The both figures show that the stresses increase over time with the shrinkage increase until the time $t = 14h$. In addition, the stresses stabilize and reduce due to relaxing effect (Figure 8). The comparison between elastic and viscoelastic calculations shows that the elastic calculation overestimates the stresses. In the viscoelastic case, the calculations yield stresses lower than in the elastic case.

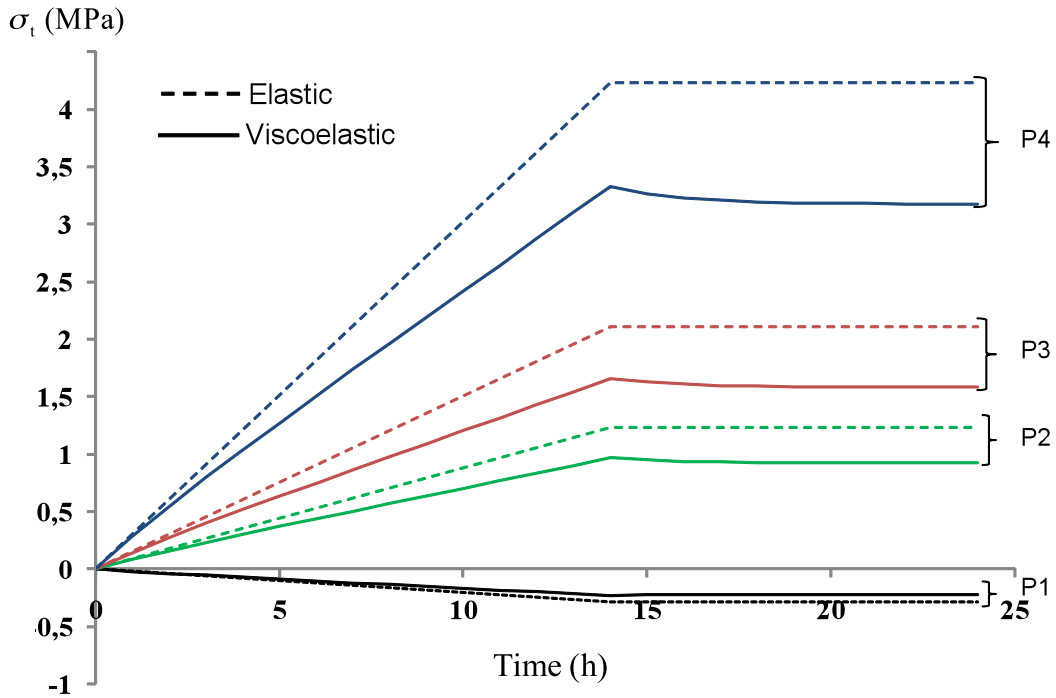

Figure 8 – Evolution of circumferential stresses along the radius (P1 to P4).

7. Conclusion

The hydro-mechanical behaviour of wood during drying and the heterogeneous and orthotropic character of the material have been recalled. The experimental setup consisted of composed of a Douglas fir green wood slice, posted on a sensitively weigh, and a video camera recorded the displacements of targets have been used. The PSF around 22% has been obtained by this technique. Then the decomposition of the relaxation tensor on the basis of a Dirichlet series has been introduced. This provided, according to the Boltzmann equation, to write the constitutive viscoelastic matrix under a free incremental strain. An algorithm incorporating the proposed incremental formulation, the humidity and the orthotropic behaviour of wood has been proposed and implemented using the finite element software Cast3m.

This model was used to simulate a green wood slice subjected to natural drying. There is the appearance of stresses due to shrinkage and the wood orthotropic character. The combined effect of water loss and the viscoelasticity of wood gives stresses below those obtained by elastic calculation. The tensile stresses are observed in the circumferential direction with distance from the heart of the slice, the reaching peak values are observed at the slice boundary. These stresses can lead to radial cracking frequently observed in the drying phase. The characterization and the study of hydro-viscoelastic effects of wood are needed to predict its behaviour and avoid the risk of cracking during the drying process.

8. References

- [1] Ormarsson S., Dahlblom O., Petersson H. Numerical study of the shape of Sawn timber subjected to moisture variation, Part 1 : Theory. *Wood Sci Technol*, 32, 325-334, 1998.
- [2] Moutee M. Modélisation du comportement mécanique du bois au cours du séchage, PhD Theses, Université Laval, Québec, 2006.
- [3] Diawanich P., Matan N., Kyokong B. Evolution of internal stress during drying, cooling and conditioning of rubberwood lumber. *Eur J Wood Prod*, 68 1-12, 2010.
- [4] Husson J.M., Dubois F., Sauvat N. Elastic response in wood under moisture content variations: analytic development. *Mech Time-Depend Mater*, 14, 203–217, 2010.
- [5] Thibault B., Gril J., Fournier M. Mechanics of wood and trees: some new highlights for an old story, *Mécanique du bois et biomécanique des arbres : nouveaux regards sur une vieille question*. *CR Mécanique*, 329, 701-716, 2001.
- [6] Coutand C., Mathias J.D., Jeronimidis G., Destrebecq J.F. TWIG: A model to simulate the gravitropic response of a tree axis in the frame of elasticity and viscoelasticity, at intra-annual time scale. *J Theor Biology*, 273, 115-129, 2011.
- [7] Chazal C., Moutou Pitti R. Incremental constitutive formulation for time dependent materials: creep integral approach. *Mech Time-depend Mater*, 2011, DOI 10.1007/s11043-011-9135-z.
- [8] Jurkiewicz B., Destrebecq J.F., Vergne A. Incremental analysis of time-dependent effects in composite structures, *Comp Struct*, 73, 425-435, 1999.
- [9] Saifouni O, Moutou Pitti R., Destrebecq J.F. An incremental constitutive law for damaging viscoelastic materials. SEM Annual Conference & Exposition on Experimental and Applied Mechanics, Mohegan Sun, Uncasville, USA, Springer New York 2011. DOI 10.1007/978-1-4614-0213-8.
- [10] Navi P., Heger F. Comportement thermo-hydromécanique du bois, Presses polytechniques et universitaires romandes, CH-1015 Lausanne, 2005.