



HAL
open science

A case study of an Intelligent Manufacturing Control based on multi-agents' system to deal with batching and sequencing on rework context

Emmanuel Zimmermann, Hind El Haouzi, Philippe Thomas, Rémi Pannequin, Melanie Noyel, André Thomas

► To cite this version:

Emmanuel Zimmermann, Hind El Haouzi, Philippe Thomas, Rémi Pannequin, Melanie Noyel, et al.. A case study of an Intelligent Manufacturing Control based on multi-agents' system to deal with batching and sequencing on rework context. 7th Workshop on Service Orientation in Holonic and Multi-Agent Manufacturing, SOHOMA'17, Oct 2017, Nantes, France. hal-01615343

HAL Id: hal-01615343

<https://hal.science/hal-01615343>

Submitted on 12 Oct 2017

HAL is a multi-disciplinary open access archive for the deposit and dissemination of scientific research documents, whether they are published or not. The documents may come from teaching and research institutions in France or abroad, or from public or private research centers.

L'archive ouverte pluridisciplinaire **HAL**, est destinée au dépôt et à la diffusion de documents scientifiques de niveau recherche, publiés ou non, émanant des établissements d'enseignement et de recherche français ou étrangers, des laboratoires publics ou privés.

A case study of an Intelligent Manufacturing Control based on multi-agents' system to deal with batching and sequencing on rework context

Emmanuel ZIMMERMANN^{1, 2, 3}, Hind BRIL EL HAOUZI^{1, 2}, Philippe THOMAS^{1, 2},
Rémi PANNEQUIN^{1, 2}, Mélanie NOYEL³, André THOMAS^{1, 2}

¹Université de Lorraine, CRAN, UMR 7039, Campus Sciences, BP 70239, 54506
Vandœuvre-lès-Nancy cedex, France

²CNRS, CRAN, UMR7039, France

(e-mail: {emmanuel.zimmermann ; hind.el-haouzi ; philippe.thomas ;
andre.thomas,remi.pannequin }@univ-lorraine.fr)

³Acta-Mobilier, parc d'activité Macherin Auxerre Nord 89270 MONETEAU
(e-mail : mnoyel@acta-mobilier.fr)

Abstract. Nowadays complex control systems are rising and especially hybrid control architectures which are developed to face the manufacturing control challenges that occur with the last industrial revolution and the emerging of industry 4.0. This work presents an application, on a testing platform, of a scheduling algorithm, with multi-criteria objectives, developed for Acta-Mobilier company suffering from high rework rate. This algorithm will inscribe itself in a hybrid control system based on smart entities. The main objective is to validate the contribution of the proposed algorithm in a disturbed environment. The platform, implemented with a multi-agent's system, allows to measure the reliability of the proposed algorithm used on a complex system in the particular case of high rework rate.

Keywords: Hybrid VSM, Multi-agent platform

1 INTRODUCTION

The growing trend of complex and customizable product presents many challenges: in one hand, the number of types and kinds of products to produce is in constant increase and needs efficient knowledge and information management. In another hand, new products introduction and continuous progress pushed to adapt and reconfigure production tools frequently. This adaptation need led, beginning 90's, to numerous initiatives involving laboratories, universities and companies. These initiative's aim was to design and implement the production systems of the future. Intelligent Manufacturing System (IMS) Project [1] has been one of the main initiatives. The basis is to develop decentralized systems with high reliability to answer both exterior or interior disturbances. However, nowadays implementations are still insufficient due to inherit inertia in every companies' paradigm changes. To evolve from hierarchical systems such as ERP or SCM systems to auto-organized and adaptive complex ones, we need deep changes in

work organization, company culture and also in technical infrastructures. That is why hybrid control solutions like the ones studied by [2] [3] since 2000 are explored.

Complex systems are generally composed by numerous autonomous entities with different adaptability levels and able to reveal important emerging phenomena. These phenomena can't be easily induced from the knowledge of their components. This is why most of new complex system architectures are implemented using the multi-agents' system paradigm. The aim of this paper is to show a case study implementing a hybrid control architecture using the multi-agents' system and a laboratory test-based platform: TRACILOGIS. The implemented scenario was based on real case study from Acta-Mobilier company. This company is a high-quality front manufacturer for kitchen and bathroom. The company suffers from a high rework rate (upper than 40 %) due to high quality requirements. A mass customisation strategy leads the company to produce in just in time but short delivery times and a large panel of different models increase the rework rate. These facts added to the customer demands variability make difficult operational planning activities. This situation causes front delivering in overdue and raises the production costs. The **Erreur ! Source du renvoi introuvable.** represents, with a macroscopic view, the production flow of Acta-Mobilier, each step represents a work-center and the grey arrows show the natural flow. The yellow arrows show the possible rework loops which could appear. These loops can happen on any step of the process and are going to four different available destinations: cutting (front completely remade), priming (putting a new primer painting layer to hide default), lacquering (putting a new layer of lacquering to hide a default) or rework (specific workstation to correct little default, not visible on the figure).

Three main flows are processed simultaneously:

- The brilliant lacquering flow: the only one passing on a polishing step

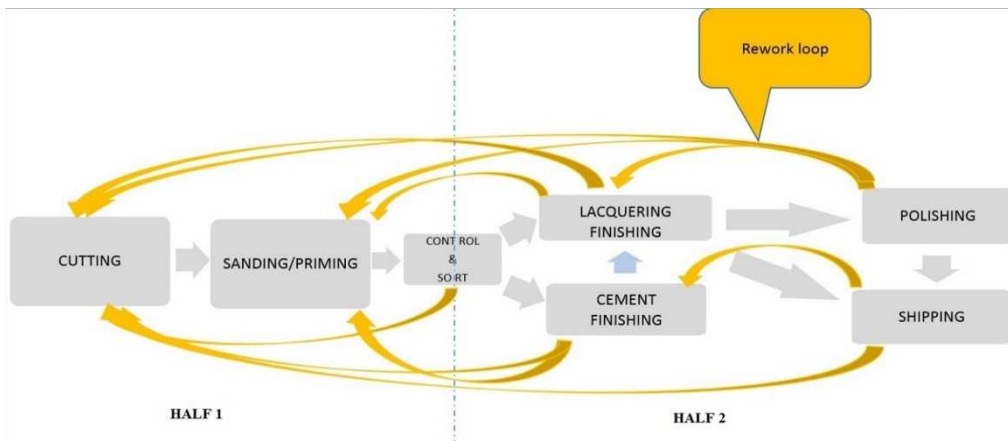

Figure 1: Acta generic process

- The matt lacquering flow: send to packaging and shipment directly after lacquering
- The cement flow with a special cement application phase before lacquering

The diagram has been cut in two parts to represent the fact that there is a significant functioning change in the production. On the first one, the fronts are gathered by front model (fronts with same physical aspect) and on second part, they are grouped by color.

There are many levers to work on to assure the production line efficiency like balancing the load between the three flows in the finishing work-center for example.

In section two, the problem is settled. In section three, a presentation of the test platform is given and the work done on the platform is described. Then, the experiment and its results are discussed. And, in last section, a conclusion is drawn and further enhancements about the platform are proposed.

2 TOWARD AN INTELLIGENT MANUFACTURING SYSTEM

Implementation of such complex adaptable systems is mainly based on the DAI (Distributed Artificial Intelligence) paradigm and OOP (Object Oriented Programming). Without being exhaustive, some agents based intelligent system architectures could be cited: YAMS [4], AARIA [5], METAMORPH [6], PROSA architecture [7] (and especially its ARTI implementation) (D4U), InteRRaP [8], ADACOR [9], Pabadis Promise [10], FrMS [11], NEIMS [12], HCBA [13] or D-MAS [14].

Finding an efficient implementation of Hybrid Manufacturing System is still a topic of high attractiveness for agile adaptable systems researchers. Lately, works like ORCA-FMS [15], PROSIS [16] or ADACOR2 [17], Service-oriented Holonic Manufacturing Systems – SoHMS) [18] were led.

Tools, criteria and models' decisions remain extremely bound to the designer preferences and their abilities and also to the studied problem specificities. CRAN investigates, with Herrera's works, a generic framework based on the VSM (Viable System Model) applied in [19]. In these works, a recursive meta-model has been proposed to improve the efficiency of the production line, reduce the delay and provide an adaptive schedule able to deal with reworks and machine failures. This control system models itself on the cybernetic core described by Beer [20]. The proposed model is a hierarchical recursive system based on smart entities. Figure 2 shows a representation of this model: on the lowest stage, there are the "Kernels" (minimal undividable group/batch of fronts having exactly the same production range). They have to be considered as autonomous entities and will be able to choose by themselves their passage order in a production batch. The next level represents these production batches, dynamics Kernels batches on one or more workstation. They will be able to dismantle and build themselves in order to reach the local objectives of every workstation according to the schedule produced by the local optimizer. All the production batches of a given customer for a given week constitute a production order. Each production order is defined by its due-date and its position in the production plan. They have to discuss to schedule themselves according to data received from their children (Kernels characteristics like color, thickness, etc. ...) and the environment (workstations breaks, weather conditions able to downgrade quality). To summarize, this chart explains that the system is made like a

living being with autonomous entities on each level having their own knowledge and sharing them with upper or lower entities following the needs.

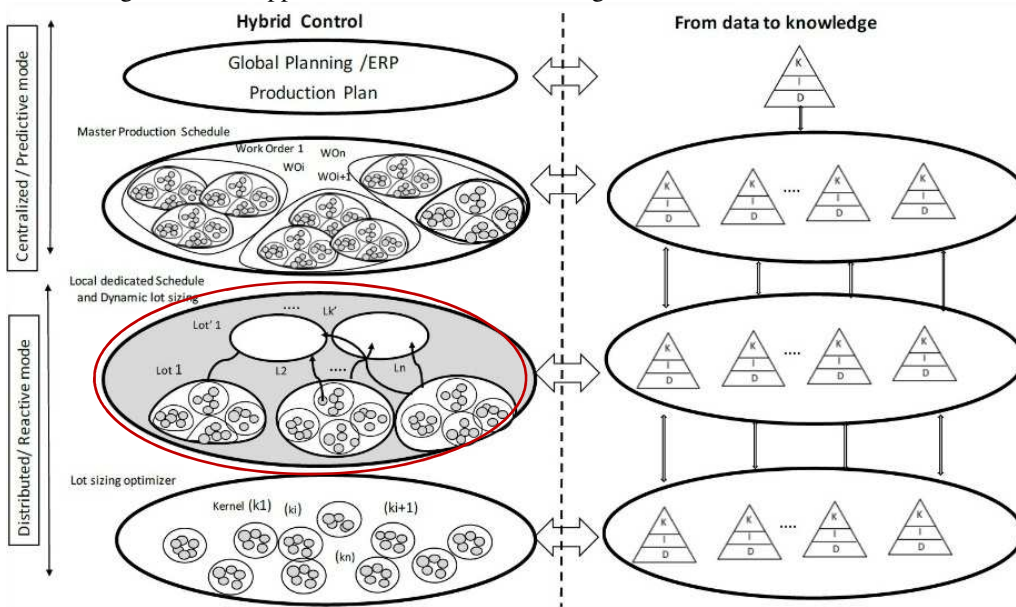

Figure 2: Proposed meta-model of a hybrid viable system

In [21] a local optimizer has been proposed in order to optimize the schedule on the cutting work center and responding to constraints of other work centers. This work corresponds to a part of the implementation of the area encircled in red on Figure 2:

- The goal in cutting work center is to minimize the number of tool changes and this way reduce the setup times.
- In finishing, finished product references have to be gathered as fast as possible and by minimizing the number of references worked simultaneously

This optimizer has been tested on a customer who orders only fronts from a single kind of flow: the cement one. Results seems meaningful but a relevant mathematical proof, impossible to obtain with the lack of retrievable data available in the company, would be appreciate.

It is non-trivial to test experimental solutions directly on the company production line due to the low action window available. That is why, the use of a test-based platform became necessary. CRAN own a platform called TRACILOGIS with the ability to test such experiments.

3 IMPLEMENTATION ON TRACILOGIS PLATFORM

3.1 TRACILOGIS platform

The TRACILOGIS test-based platform provides a test environment for many industrial scenarios on classification, identification and intelligent manufacturing control with different modes: centralized, distributed or hybrid (centralized and distributed). In addition, it allows to implement, test and compare various traceability and control techniques within the logistics chain, in particular for the wood industry. The physical system is composed of four automatons. They all handle their own part of the platform. The products are platter which can be marked with a point or a line on one of their border. They can receive between zero and four pallets and/or zero to four pastilles. The global Platform physical processes are shown on the figure 3.

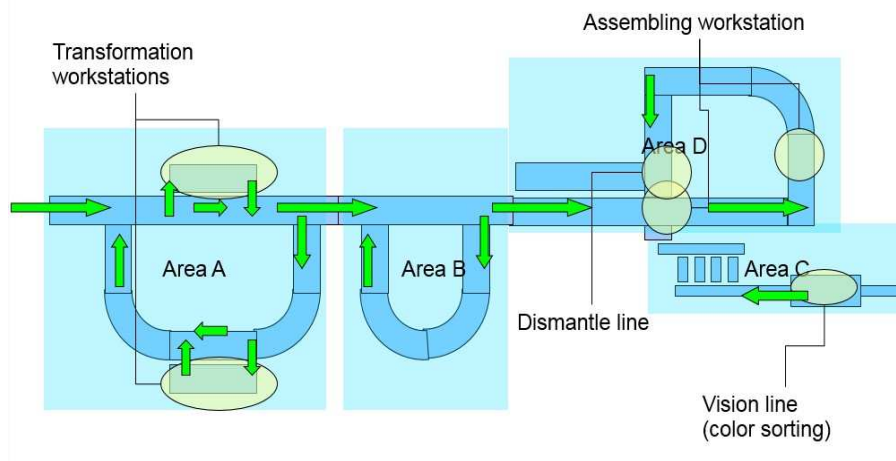

Figure 3: TRACILOGIS flowchart

- Automaton A handles a trail made up of two marking workstations. The workstations are placed sequentially but each one can be dodged thanks to referral. **Erreur ! Source du renvoi introuvable.** area A.
- Automaton B manages a looping area which allows to re-order products in a different way. **Erreur ! Source du renvoi introuvable.** area B.
- Automaton C manages a sorting trail using a camera system to recognize pallet colors.
- D automaton handles an assembly line: adds the pallets and the pastilles on the platter according to the production range and then leads the products to one of the two exits **Erreur ! Source du renvoi introuvable.** area D.
- Both platters and pallets have RFID tags and readers are placed on each workstation and decision points.

The multi-agent system, developed with JADE, manages the sending of all the actions to realize to automatons. The transmission is triggered by the behaviors implemented in the agents. Interactions are made by transmitting asynchronous messages. In a multi-agent system, a not necessary known number of agent are evolving. Every one of them is in interaction with the others in order to reach a common goal. They can act also on a defined number of objects. A multi-agent system aims to maintain: a constant communication, the control and the knowledge organization between the agents.

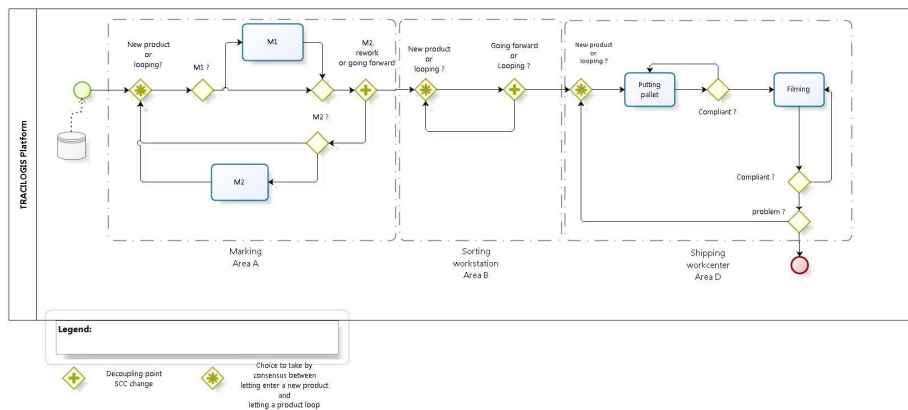

Figure 4: TRACILOGIS flowchart

Initially agents were instantiated for the following kind of actor on the platform:

- The resource agents are passive agents which wait for instructions from products
- The product agents: they know their objectives and their production range, they recalculate at every move the shortest path to their final destination. They are well-known of their actual state but haven't awareness of the other product agents. The UML diagram of this agent is presented in Figure 5.
- The PLC (Production Line Controller) agents manage all of the automaton actions of their area.

3.2 Transposition of Acta-Mobilier case study on the test-based platform

The platform TRACILOGIS gives the opportunity to seek different kind of scenario. The principal issue is to create study cases as near as possible of the industrial one in order to be relevant and make the platform evolve to realise these scenarios. Moreover, the reliability of a multi-agent system in response to reworks disturbances could be analysed.

- Area A of the platform could be associated to the cutting work-center. The first machine can be seen as the normal flow of cutting and the second as a special flow for particular model which is longer.

- Area B which is a simple loop workstation could be compared to the sorting phase of the company. This phase consists in verify the completeness of the

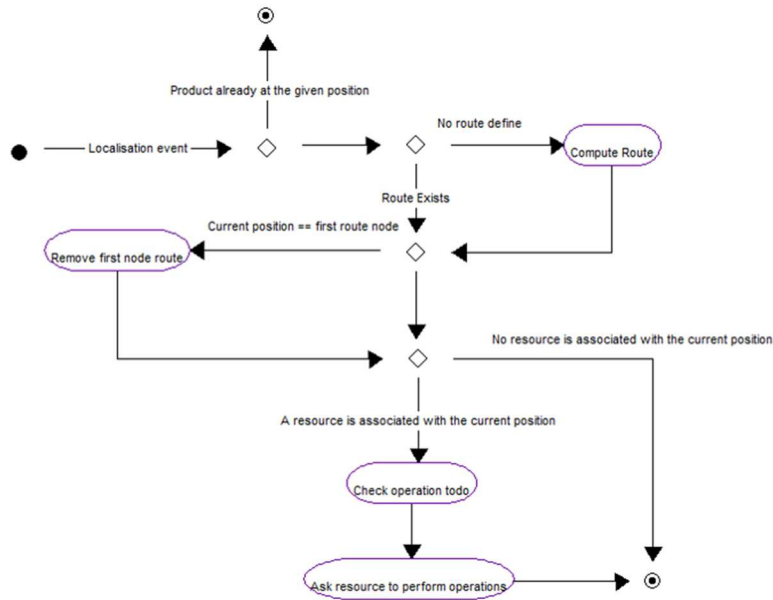

Figure 5: Product agent UML

lots and regroup them by colour. The worker will let the batch follows its way according to the production plan.

- Area D is compared to the finishing and shipment work-centers. For this experiment this area isn't really useful. Figure 6 resumes all these equivalences.

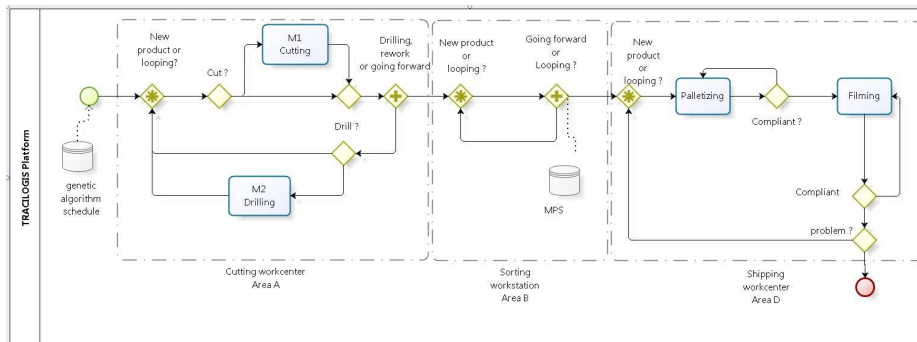

Figure 6: Problem transposition from Acta to TRACILOGIS

First implementation to add was the introduction of reworks. A random rule is placed in the resource agent behaviour to send a message to the product agent of a failure. When the product receives this answer, it will recalculate the shortest path to the machine.

A schedule agent has been introduced in order to assume that all the product which exit from area B are respecting the schedule otherwise the product will loop. The product agent communicates with this agent to know if they have the right to pass.

4 EXPERIMENTAL RESULTS

A production of ten products has been implemented. 3 different configurations were chosen: 4 products with a line made on machine M1 (config α of Figure 7), 3 products with a point made on machine M1 (config β of Figure 7) and 3 products with a line made on machine M2 (config γ of Figure 7).

Config α corresponds to a line drawn on the right side of the product, operation available only on machine M1.

Config β is a point drawn on the right side of the product, only available on machine M1 too.

Config γ is a line plotted on the left side of the product, this operation is made on machine M2 and as shown on fig 6, to go to M2 the product should take the first looping road. That's why there is a 10 seconds transfer time.

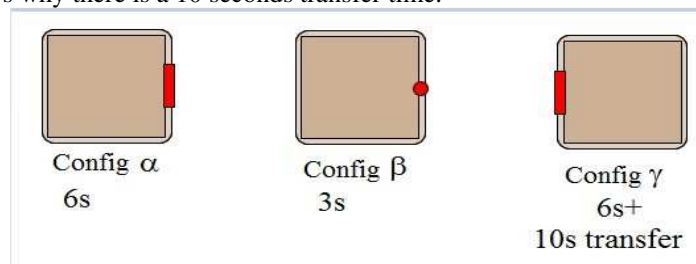

Figure 7: Configuration list

The ten products are grouped in 3 customer orders: Order red: $\alpha\beta\gamma$, Order green: $\alpha\beta\gamma$ and Order blue: $\alpha\beta\beta\gamma$. The three orders have the same due-date.

To suit to Acta process, as soon as a product from a specific order go through area B, the others products which don't belong to the same order will loop until the order is complete. To validate the advantages of the proposed solution, three different production schedule scenarios were tested:

- Each customer order is launched as a single batch without considering the setup optimization. Only the date is considered to schedule the jobs. This scenario has been named "to order schedule".
- The schedule is done based on the Due Date and operation change optimization (setup time). This scenario was named DDS schedule.
- The schedule is done based on the results of the genetic algorithm (dealing with a tradeoff between setup time and WIP. In this case the WIP is estimated by the number of loops). This one was named GA schedule.

The following schedules have been established according to the three piloting rules described previously:

- Schedule 1: $\alpha\gamma\beta\beta\gamma\alpha\alpha\beta\beta\gamma$
- Schedule 2: $\alpha\alpha\alpha\beta\beta\beta\beta\gamma\gamma\gamma$
- Schedule 3: $\beta\beta\beta\alpha\alpha\gamma\gamma\alpha\beta$

Table 1 shows the results considering four aspects:

- 1) the number of looping needed to respect a specific piloting rule: only product from a same order can go through area B, others have to loop until all the product of the previous order have gone through area B. In other words, it corresponds to the measurement of the work in progress.
- 2) the makespan.
- 3) the maximal number of Finished Product References in Progress simultaneously (FPRP). In the schedules 1,2,3 products were colored with three different colors, each of them represents a FPR and one of the main objective of the genetic algorithm proposed is to minimize the number of FPR worked simultaneously because the more distinct FPR are opened the largest floor space to treat them is needed.
- 4) the number of operation changes. Each operation change should be seen as a setup time.

The first part of the tests is made without reworks introduction. For these three experiments only two runs were realized (a normal and a control one) because no random was introduced in the system.

	to order	DDS	GA
Number of loop	2	8	3
Makespan	5min 08 s	4 min 44 s	4 min 56 s
Max FPRP	1	3	2
Operation Changes	6	2	4

Table 1: Experiment results without reworks

In this first part, it is obvious to note that the “to order” schedule offers the less number of loops but also the maximal number of operation changes. This schedule is the longest because it doesn’t take care of the optimisation in operation but allows to work only a single FPR at a time.

Conversely, the minimizing setup times schedule gives the lowest number of changes but maximize the number of loop and the number of FPR worked together.

The proposed GA has the advantage to provide a compromise solution of the others. Table 2 shows the results with a twenty percent rework’s probability. For these ones, a set of ten runs were made and an average of the results is presented.

	To order	DDS	GA
Number of loop	3	12	5
Makespan	9 min 38 s	9 min 13 s	9 min 21 s
Max FPRP	2	3	2
Operation Changes	6+5	2+4	4+4

Table 2: Experiment results with 20% rework’s probability

Comparing to the first part, results are quite similar, except the fact that all the production times have more than doubled. However, the proposed GA solution seems to be robust to reworks.

The makespan measure dispersion is presented on Figure 8. Through this diagram the “to order” scheduling is the one with the lowest dispersion but with results globally worse than the others. GA has the highest dispersion but also the best results. It could be explained because of the algorithm number of iteration. This number is limited to maintain the computation. Increase this number will probably allow to limit the dispersion of the solution and in the same time enhance the median. It will be interesting to evaluate the available computation time in order to maximize it utilization. Moreover, seeing that the junction between the median is not linear the scheduling strategy has a real impact on the makespan.

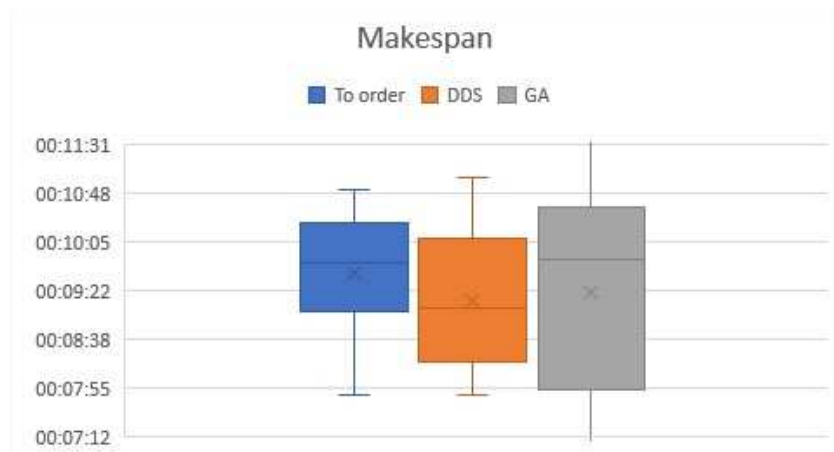

Figure 8: Makespan measure dispersion

5 CONCLUSIONS AND OUTLOOKS

The average results highlight that the proposed solution seems to be a good compromise to limit the number of operation changes and to limit the work in progress despite existing reworks. An interesting point not visible with the results but noted during the runs on the TRACILOGIS is: the proposed algorithm, by grouping similar products and still pay attention to keep products from the same order as near as possible, allows to switch products from an order to another in case of reworks. This fact isn't really useful for a company like Acta because of its mass customisation strategy but can still be relevant for companies with less distinct models. To be even more relevant, much more experiment should be made and with several distinct rework rates.

Further improvements to add to the platform and its multi-agent system would be to implement a consensus decision to choose the best solution between letting a new product enters or work on a rework. A batch agent must also be added to match with the notion of finished product reference and to maintain a communication between all the

products with the same reference. The next step to reach will be to recalculate the schedule dynamically each time a rework appears.

ACKNOWLEDGMENT

The authors gratefully acknowledge the financial support of the CPER 2007-2013 Structuration du Pôle de Compétitivité Fibres Grand'Est (Competitiveness Fibre Cluster), through local (Conseil Général des Vosges), regional (Région Lorraine), national (DRRT and FNADT) and European (FEDER) funds used to implement The TRACILOGIS Platform.

REFERENCES

- [1] H. Yoshikawa, "Manufacturing and the 21st century-intelligent manufacturing systems and the renaissance of the manufacturing industry," *Technological Forecasting and Social Change*, pp. 195-213, 1995.
- [2] C. Herrera, S. Belmokhtar and A. Thomas, "Viable system model approach for holonic product driven manufacturing systems," *1st Workshop on Service Orientation in Holonic and Multi Agent Manufacturing Control, SOHOMA 2011*, 2011.
- [3] C. Herrera, A. Thomas, S. Belmokhtar and R. Pannequin, "A viable system model for product-driven systems," *International Conference on Industrial Engineering and Systems Management, IESM 2011*, 2011.
- [4] H. Van Dyke Parunak, "Manufacturing experience with the contract net," *Distributed artificial intelligence*, pp. 285-310, 1987.
- [5] H. Van Dyke Parunak, A. Baker and S. Clark, "The AARIA agent architecture: an example of requirements-driven agent-based system design," in *AGENTS'97 first international conference on autonomous agents*, AGENTS'97 first international conference on autonomous agents, 1997.
- [6] F. Maturana, W. Shen and D. Norrie, "MetaMorph: an adaptive agent-based architecture for intelligent manufacturing," *international Journal of Production Research*, pp. 2159-2173, 1999.
- [7] H. Van Brussel, J. Wyns, P. Valckenaers, L. Bongareerts and P. Peeters, "Reference architecture for holonic manufacturing systems: PROSA," *Computers in Industry*, pp. 255-274, 1998.
- [8] K. Fisher, "Agent-based design of holonic manufacturing systems," *Robotics and Autonomous Systems*, pp. 3-13, 1999.
- [9] P. Leitao, "An agile and adaptive holonic architecture for manufacturing control," Thèse, University of Porto, 2004.
- [10] D. Wunsch and A. Bratukhin, "Multilevel order decomposition in distributed production," in *12th IEEE Conference on Emerging Technologies*

and Factory Automation EFTA'07, 12th IEEE Conference on Emerging Technologies and Factory Automation EFTA'07, 2007.

- [11] K. Ryu and M. Jung, "Agent-based fractal architecture and modelling for developing distributed manufacturing systems," *International Journal of Production Research*, pp. 4233-4255, 2003.
- [12] W. Gu, D. Tang, K. Zheng and L. Wang, "A neuroendocrine-inspired bionic manufacturing system," *Journal of Systems Science and Systems Engineering*, pp. 275-293, 2011.
- [13] J. L. Chirn and D. C. McFarlane, "A holonic component-based approach to reconfigurable manufacturing control architecture," *Database and Expert Systems Applications*, pp. 219-223, 2000.
- [14] P. Verstraete, P. Valckenaers, H. Van Brussel, B. Saint Germain, K. Hadeli and J. Van Belle, "Towards robust and efficient planning execution," *Engineering Applications of Artificial Intelligence*, vol. 21, no. 3, pp. 304-314, 2008.
- [15] C. PACH, T. BERGER, T. BONTE and e. al, "ORCA-FMS: a dynamic architecture for the optimized and reactive control of flexible manufacturing scheduling," *Computers in Industry*, vol. 65, no. 4, pp. 706-720, 2014.
- [16] P. PUJO, N. BROISSIN and F. OUNNAR, "PROSIS: An isoarchic structure for HMS control," *Engineering Applications of Artificial Intelligence*, vol. 22, no. 7, pp. 1034-1045, 2009.
- [17] S. DEBNATH, J. QIN, B. BAHRANI and e. al, "Operation, control, and applications of the modular multilevel converter: A review," *IEEE transactions on power electronics*, vol. 30, no. 1, pp. 37-53, 2015.
- [18] F. G. QUINTANILLA, O. CARDIN and P. CASTAGNA, "Product Specification for Flexible Workflow Orchestrations in Service Oriented Holonic Manufacturing Systems," pp. 177-193, 2014.
- [19] E. Zimmermann, H. Bril, P. Thomas, A. Thomas and M. Noyel, "A hybrid manufacturing control based on smart lots in a disrupted industrial context," *IFAC WORLD CONGRESS*, 2017.
- [20] B. Stafford, "The Viable System Model: Its Provenance, Development, Methodology and Pathology," *The Journal of the Operational Research Society*, vol. 35, no. 1, pp. 7-25, 1984.
- [21] E. Zimmermann, H. Bril, P. Thomas, A. Thomas and M. Noyel, "A batching and scheduling optimisation for a cutting work-center: Acta-Mobilier case study," *IESM*, 2017.