



HAL
open science

Dark-fermentative biohydrogen pathways and microbial networks in continuous stirred tank reactors: Novel insights on their control

Rodolfo Palomo-Briones, Elías Razo-Flores, Nicolas Bernet, Eric Trably

► To cite this version:

Rodolfo Palomo-Briones, Elías Razo-Flores, Nicolas Bernet, Eric Trably. Dark-fermentative biohydrogen pathways and microbial networks in continuous stirred tank reactors: Novel insights on their control. *Applied Energy*, 2017, 198, pp.77-87. 10.1016/j.apenergy.2017.04.051 . hal-01608465

HAL Id: hal-01608465

<https://hal.science/hal-01608465>

Submitted on 4 Aug 2023

HAL is a multi-disciplinary open access archive for the deposit and dissemination of scientific research documents, whether they are published or not. The documents may come from teaching and research institutions in France or abroad, or from public or private research centers.

L'archive ouverte pluridisciplinaire **HAL**, est destinée au dépôt et à la diffusion de documents scientifiques de niveau recherche, publiés ou non, émanant des établissements d'enseignement et de recherche français ou étrangers, des laboratoires publics ou privés.

Dark-Fermentative biohydrogen pathways and microbial networks in CSTR:
novel insights on their control

Rodolfo Palomo-Briones^{a*}, Elías Razo-Flores^a, Nicolas Bernet^b, Eric Trably^b

^aDivisión de Ciencias Ambientales, Instituto Potosino de Investigación Científica y Tecnológica, A.C. Camino a la Presa San José 2055, Lomas 4a Sección, C.P. 78216, San Luis Potosí, S.L.P., México.

^bLBE, INRA, 102 avenue des Etangs, 11100, Narbonne, France.

*Corresponding author: Rodolfo Palomo-Briones, rodolfo.palomo@ipicyt.edu.mx

Abstract

In the present work, the influence of hydraulic retention time (HRT) on dark fermentation metabolism was evaluated through the operation and analysis of a series of four continuous stirred tank reactors (CSTR) at four HRT ranging from 6 h to 24 h. A maximum volumetric hydrogen production rate (VHPR) of 2000 ± 149 mL/L-d corresponding to an H_2 yield of $0.86 \text{ mol}_{H_2}/\text{mol}_{\text{lactose}}$ was observed at 6 h HRT. In depth analysis of metabolite profiles and microbial communities showed that low values of HRT favored the emergence of a community dominated by *Clostridiaceae-Lachnospiraceae-Enterobacteriaceae*, which performed metabolic pathways co-producing hydrogen. In contrast, long HRT led to the establishment of *Sporolactobacillaceae-Streptococcaceae* microbial community that outcompeted H_2 producing bacteria (HPB) and was responsible of lactate production. Results suggested that these two communities mutually excluded themselves and HRT can act as a operational parameter to control the microbial communities and consequently the related metabolic pathways.

Keywords: Biohydrogen; Dark fermentation; Hydrogen-Producing Bacteria; Metabolic network; Lactic Acid Bacteria.

1. Introduction

Biohydrogen is worldwide considered as one of the most promising alternatives to substitute fossil fuels in a near future. Indeed, hydrogen is not only characterized by its high density of energy (123 kJ/g ~ 2.75), but also the efficiency of its conversion to electric energy is relatively high, and its utilization does not generate any greenhouse gases.

Amongst the technologies available to produce hydrogen, biological processes are environment friendly and can convert a wide variety of abundant organic biomass at low cost. In particular, biological production of hydrogen by dark fermentation (DF), so called biohydrogen, can be emphasized for its large use of sustainable substrates, the high hydrogen production rates, and its simplicity of operation [1]. In contrast with the photo-fermentation processes, DF does not require light to occur, thus reactor design is simpler and its operation is not limited by light-darkness natural cycles.

In brief, a fermentation process is the biological oxidation of organic compounds where the same substrate molecule plays a role as a carbon source, an electron donor- and an electron-acceptor, i.e. a part of the molecule is oxidized while another part is reduced [2]. In particular, the DF process can be defined as the partial oxidation of organic substrates (mainly carbohydrates) without external electron acceptor. DF leads to the production of low weight organic molecules (volatile fatty acids -VFA- and alcohols) altogether with hydrogen generation. Such metabolic process can be carried out by mixed cultures of bacteria, the most representative members being related to *Prevotella*, *Lactobacillus*, *Clostridium*, *Selenomonas*, *Megasphaera* and *Enterobacter* genera [3].

Metabolically, the maximum theoretical hydrogen yield of DF is 4 moles of hydrogen per

mol of glucose consumed through the acetate pathway [4]. In practice, H₂ yields reported for mesophilic cultures [5–8] are about 1.3 mol_{H₂}/mol_{glucose} in average, while only few studies have reported hydrogen yields beyond 3 mol_{H₂}/mol_{hexose} [6]. Low hydrogen yields are probably linked to the complexity of microbial communities and metabolic pathways presented in the DF.

In a dark fermentative community some members such as *Clostridium* and *Enterobacter* genera are efficient hydrogen producers while others play different roles not necessarily linked to hydrogen production, for instance, homoacetogens and lactic acid bacteria (LAB). On one hand, homoacetogens can use carbon dioxide or carbon monoxide and hydrogen as sole carbon and energy sources under anaerobic conditions, along with the synthesis of acetate [9–12]. Previous studies showed homoacetogenesis as the cause of 36-56% of the total acetate observed in the fermentation media, resulting in hydrogen productivities 45-90% lower than expected [10]. Other authors reported that hydrogen consumption by homoacetogens was equivalent to 250 mmol/d at 8 h of HRT in UASB reactors [13]. To avoid this type of metabolism, several strategies consisting in the reduction of hydrogen accumulation have been suggested (e.g. gas sparking [14]).

On the other hand, LAB constitutes a microbial group commonly found in DF systems (e.g. [15–19]) which includes microorganisms of the families *Lactobacillaceae*, *Enterococcaceae*, *Streptococcaceae*, *Sporolactobacillus*, etc. Despite of their ubiquity, the role of LAB in DF has been scarcely studied [20]. Some authors argued that LAB compete with hydrogen producers for carbon sources [21], while others have widely discussed that the excretion of bacteriocins could be the main cause of DF failure [18,19].

Up to date, most of the reports in literature about LAB and other important microbial groups have been studied circumstantially. Their effects on fermentation performances, metabolic pathways and their roles in the microbial community of DF. A full understanding of these issues is fundamental to conduct better control and advance towards the implementation of the biohydrogen production technology at the industrial scale. In this direction, the study of the factors that determine the occurrence of these groups in dark fermentative systems is a pending task.

Therefore, throughout the experiments carried out in this work, hydraulic retention time (HRT) was evaluated as a potential factor to shape the metabolic pathways and microbial communities in continuous dark fermentative systems. Due to its simplicity and practicality in real life operation in comparison with other strategies, HRT could be of high importance for metabolic and microbial community control. Moreover, a microbial network analysis was used to reveal the interactions among the involved species. This methodology provides highly important information for the engineering and/or design of microbial communities, which is an alternative to enhance hydrogen production.

2. Materials and methods

2.1. Inoculum source and substrate

Disaggregated anaerobic sludge from a full-scale municipal wastewater treatment plant (Marseille, FR) was used as initial source of microorganisms. Before inoculation, the sludge was thermally treated by boiling during 2 hours. Seed sludge was added into a continuous stirred tank reactor (CSTR1) of 3.1 L total volume and 2L working volume,

(APPLIKON Biotechnologies, USA) at a final concentration of 4.5 g/L of volatile suspended solids (VSS). The reactor was started in batch mode for 24 h, whereupon the bioreactor was operated in continuous mode for 25 d with a HRT of 6 h. When CSTR1 reached a stable state (lactose degradation efficiency, $46 \pm 2\%$; VHPR, $2448 \pm 461 \text{ L}_{\text{H}_2}/\text{L-d}$; H_2 yield, $0.89 \text{ mol}_{\text{H}_2}/\text{mol}_{\text{lactose}}$) 10 L of effluent were recovered and stored in 4 containers (2.5 L each) at $-20 \text{ }^\circ\text{C}$ until their re-use as microbial inoculum for the subsequent experiments in reactors CSTR2, CSTR3, CSTR4 and CSTR5. A schematic representation of the utilized system is shown in Figure 1.

For all reactors, lactose was used as substrate at a concentration of 20 g/L. The fermentative medium was supplemented with the following components (mg/L): $\text{MgCl}_2 \cdot 6\text{H}_2\text{O}$, 100; $\text{CuCl}_2 \cdot \text{H}_2\text{O}$, 1.25; $\text{MnCl}_2 \cdot 4\text{H}_2\text{O}$, 7; $\text{FeCl}_2 \cdot 4\text{H}_2\text{O}$, 19.1; $\text{NiCl}_2 \cdot 6\text{H}_2\text{O}$, 102.5; yeast extract, 500. Additionally, a phosphate buffer ($\text{KH}_2\text{PO}_4\text{-Na}_2\text{HPO}_4$, $\text{pH}=5.9$) was added at a final concentration of 50 mM.

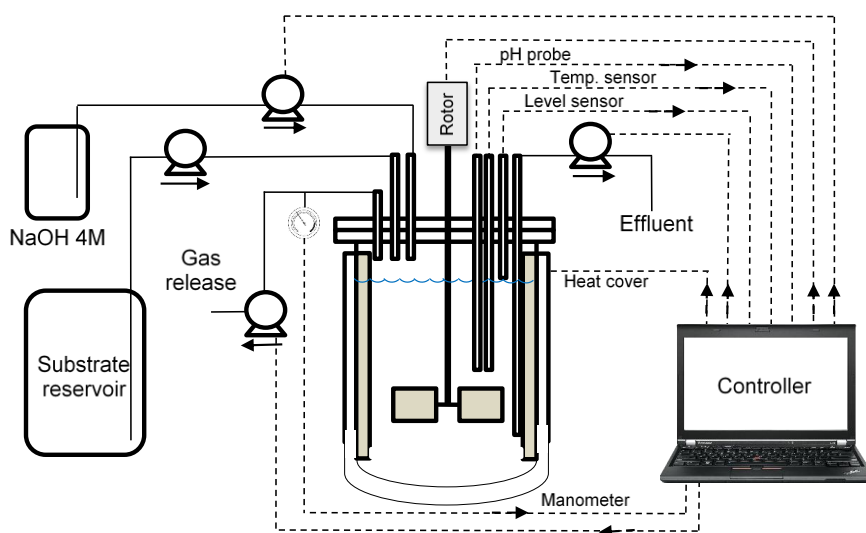

Figure 1. Schematic representation of the experimental set-up used in this work.

2.2. Experimental conditions

A series of 4 continuous stirred tank reactors (CSTR2 to CSTR5), 2 L working volume and 1.1 L of head space, were inoculated (same volume of 1L each, initial VSS 0.5 g/L for all cases) with frozen effluents from CSTR1. Reactors were first operated in batch mode for 24 h using lactose at a fixed concentration of 20 g_{lactose}/L. Thereafter, the reactors were operated at the following HRT: CSTR2, 6 h; CSTR3, 12 h; CSTR4, 18 h and CSTR5, 24 h for an equivalent time of 20 HRT, i.e. 120 h, 240h, 360h and 480h of operation, respectively. Stirring and temperature were set and regulated at 200 rpm and 37 °C, respectively, while the pH was continuously adjusted to 5.9 by proper addition of 4M NaOH.

2.3. Analytical methods

Gas production was monitored with a pressure control system that was configured to release the gas produced when pressure was above 1.1 bars. Gas composition (H₂ and CO₂) was determined through a gas chromatograph GC-8A equipped with a thermal conductivity detector (Shimadzu). Calibration was performed using three external gas standards: 5% CO₂ and 5% N₂ in methane, 20% CO₂ and 20% N₂ in methane, and 100% H₂, injected as 0.5 mL at 1 atm.

VFA and alcohols were quantified using high performance liquid chromatography (HPLC) coupled to a refractometer (Waters R410). Liquid samples were centrifuged at 13000 rpm for 15 min and filtered with 0.2 µm nylon filters. HPLC analysis was performed at a flow rate of 0.8 mL min⁻¹ using an Aminex HPX-87H, 300 x 7.8 mm (Bio-Rad) column at a

temperature of 35 °C. H₂SO₄, 4 mM was used as mobile phase. COD and VSS were analyzed according to the standard methods [22].

2.4. Microbial community analysis

DNA extraction was performed with the Fast DNA SPIN Kit for soil in accordance with the manufacturer's instructions (MP Biomedicals). PCR amplification of the bacterial 16S rRNA was conducted with Pfu Turbo DNA polymerase (Stratagene) and universal primers (5'-ACGGTCCAGACTCCTACGGG-3', *Escherichia coli* position F331; and 5'-TTACCGCGGCTGCTGGCAC-3', *E. coli* position R500) targeting the V3 region. The PCR conditions were as follows [23]: initial denaturation for 2 min at 94°C; 25 cycles of melting (1 min at 94°C), annealing (1 min at 61°C) and extension (1 min at 72°C); and a final extension step of 10 min at 72°C.

PCR products were analyzed by Capillary Electrophoresis Single Strand Conformation Polymorphism (CE-SSCP) in an ABI 3130 genetic analyzer (Applied Biosystems) according with a previous report [24]. The CE-SSCP profiles were aligned based on the ROX internal standard to take into account inter-sample electrophoretic variability and were normalized with the package *Statfingerprints* in R platform [25]. From CE-SSCP fingerprints, Shannon's diversity index and Gini's coefficient were calculated as described previously [26].

In order to elucidate the identity of the microorganisms, a PCR-based 454-pyrosequencing was carried out. The PCR for 454 pyrosequencing was targeting the V4-V5 regions, using the universal primers 515-532F and 909-928R. The sequencing work was developed by the

GeT PlaGe sequencing center of the genotoul life science network in Toulouse, France (get.genotoul.fr). The downstream sequences processing involved a chimeric analysis to validate the quality of the recovered sequences using an slightly modified version of the Standard Operation Procedure reported elsewhere [27]. The SILVA ribosomal RNA database (<https://www.arb-silva.de/>) was used for alignment and as taxonomic outline search of their taxonomic affiliation comparing to data bases.

2.5 Multivariate analysis and Pearson's correlations

Principal Components Analysis (PCA) was performed to determine possible relationships between microbial community, fermentation performance and operational parameters. The PCA was carried out using R software and *factoextra* package. As discussed elsewhere [28,29], PCA is a multivariate procedure which basically calculates new synthetic variables (principal components), which are mutually independent, uncorrelated, mathematically represented as a linear combinations of the original variables, and that account for as much of the variance of the original data as possible. To avoid overfitting, a second PCA was conducted considering a reduced number of factors selected on the basis of their weight.

Besides the multivariate analysis, a Pearson's correlation analysis was carried out with the information of microbial community, fermentation performances and operational parameters to give better insight on the different relationships occurring within the system. This analysis was performed in R software [25], using the *corrplot* package.

2.6 Microbial community networks

The network inference was performed following the protocol proposed by Faust et al. [30].

In brief, four similarity measurements (Bray–Curtis and Kullback–Leibler dissimilarity, Pearson and Spearman correlation) were computed for a dataset composed by families with abundances >1% and observed in at least three samples. The p-value of each measurement was performed according with the permutation-renormalization and bootstrap (ReBoot) method [31]. Measure-specific p-values were merged following the Brown's method. Finally, edges with merged p-values<0.05 were kept. The whole network construction was performed within *Cytoscape* environment, using the *CoNet* application [32].

3. Results and discussion

3.1. HRT determines dark fermentation performances and metabolites distribution

A series of four CSTR fermentation reactors was operated for an equivalent time of 20 HRT each, using lactose at 20 g/L as substrate. Each CSTR was operated under an unique HRT value ranging from 6 to 24h (CSTR2, 6 h; CSTR3, 12h; CSTR4, 18h; CSTR5, 24h), at pH 5.9 and 37°C.

Results showed that HRT had an important impact on DF performances in terms of lactose consumption, H₂ yield, and volumetric hydrogen production rate (VHPR) (Figure 2).

Overall, lactose degradation efficiency was enhanced by increasing the HRT, from 35% in CSTR2 (HRT = 6h) up to 82% in CSTR5 (HRT = 24h). In contrast, VHPR showed a gradual decrease from 2000 ± 149 mL_{H₂}/L-d in CSTR2 to 604 ± 143 mL_{H₂}/L-d in CSTR5.

A maximum H₂ yield of 0.86 mol_{H₂}/mol_{lactose} was found in the CSTR2 at 6h HRT. The relationships observed between HRT and both VHPR and H₂ yields were consistent with previous studies where comparable trends were also reported, for instance, by employing

halophilic bacteria [33], using peach nectar and pulp as substrates [34], or when operated under reduced pressure [35]. For the specific case of lactose, the results presented in this work were below the range of previous studies [5,36,37]. Factor such as the composition of growth media or the source of inoculum could be among the possible causes of the relatively low VHPR. As discussed previously [38], it is widely accepted that short HRT improves the hydrogen-producing process by suppressing the growth of undesirable microorganisms unable to growth at long dilution rates. At the same time, short HRT is an effective strategy for the establishment of stable hydrogen-producing microbial communities. A summary of literature studies in regard with HRT and metabolic and microbial community changes is shown in Table 1.

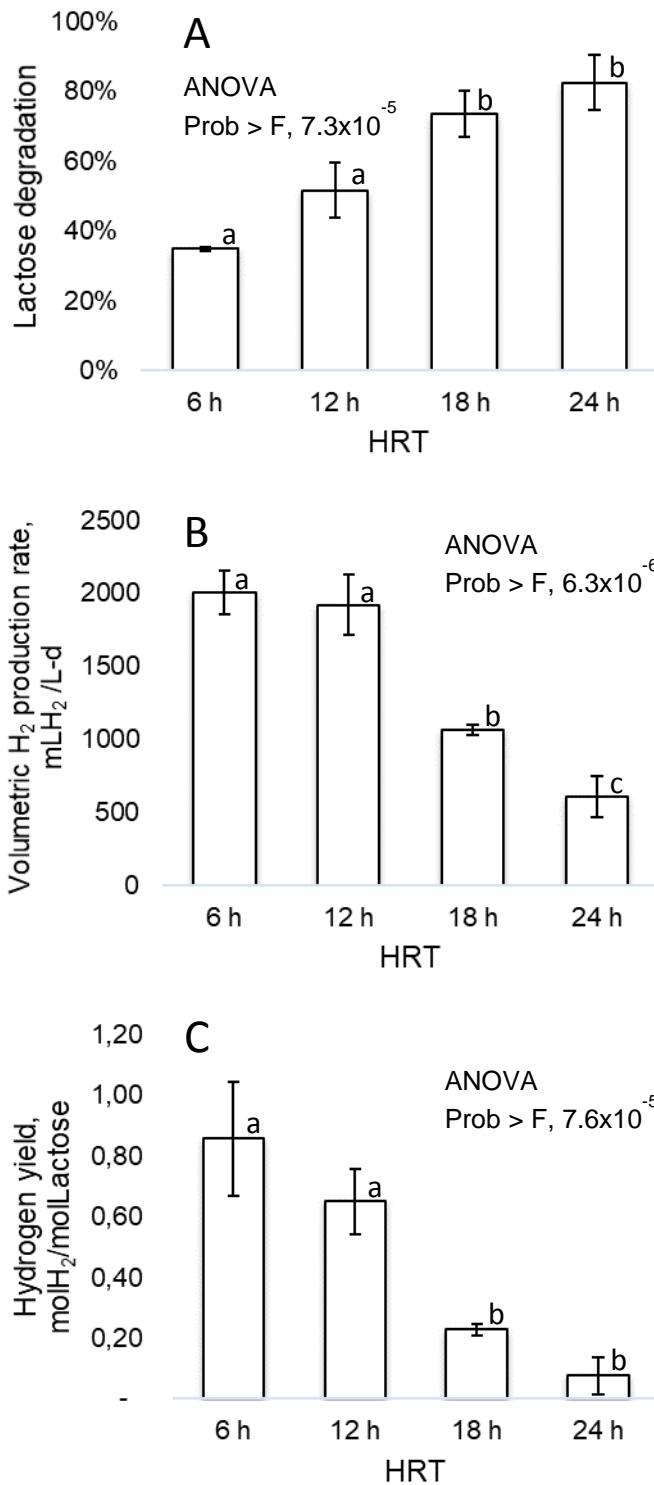

Figure 2. Summary of the influence of HRT on the performance of CSTR during dark fermentation. For each case, the three last samples were considered. Bars with the same lower case letter were not significantly different at a level 0.05 according with Tukey's tests.

Table 1. Selected studies of biohydrogen production in CSTR.

Ref.	Substrate	Inoculum	HRT ^a	VHPR ^b	HY ^c	Changes on the metabolic pathways	Changes on the microbial community	Microbial groups
[33]	Glucose	<i>Clostridium bifermentans</i>	6-24	3.8-5.5	0.7-1.1 mol _{H₂} /mol _{Glu}	□ Lactate (HRT=18h) diminished H ₂ yield	-	<i>Clostridiaceae</i>
[5]	Cheese whey	Anaerobic sludge	4-10	2.7-11.3	0.5-1.2 mol _{H₂} /mol _{Hex}	-	□ <i>Clostridium</i> was dominant at HRT 10, 6 and 4 h □ <i>Streptococcus</i> and <i>Enterococcus</i> presented at low HRT (6 & 4 h)	<i>Clostridiaceae</i> , <i>Enterococcaceae</i> <i>Streptococcaceae</i>
[39]	Sugarcane syrup	<i>Clostridium butyricum</i>	2-12	1.18-17.5	0.3-1.32 mol _{H₂} /mol _{Hex}	□ High concentrations of lactate were observed at large HRT	□ LAB (<i>Acatostipes</i>) disappeared with the decrease in HRT □ Relative abundance was not assessed.	<i>Clostridium</i> , <i>Tetrasphaera</i> , <i>Flammeovirga</i> , <i>Tissierella</i> , <i>Butyrivibrio</i> , <i>Desulfobulbus</i> , <i>Olsenella</i> <i>Acotostipes</i>
[40]	Glucose	Anaerobic sludge	4-12	4.56-14.4	0.75-1.57 mol _{H₂} /mol _{Hex}	□ Short HRT led to reduction of propionate production	□ Shortening the HRT reduced the microbial diversity of the community □ No further correlation was performed	<i>Clostridiaceae</i>
[41]	Sugarcane juice	<i>Clostridium butyricum</i>	4-36	0.13-1.81	0.05-1 mol _{H₂} /mol _{Hex}	□ Short HRT led to reduction of propionate production	□ <i>L. arbinses</i> and <i>C. butyricum</i> were dominant at all HRT	<i>Lactobacillus harbinensis</i> , <i>Klebsiella pneumoniae</i> , <i>Clostridium butyricum</i>
This work	Lactose	Anaerobic sludge	6-24	0.6-2	0.08-0.86 mol _{H₂} /mol _{Lactose}	□ Short HRT (6-12 h) were associated with H ₂ producing pathways. □ Large HRT (18-24h) were strongly associated with lactate in detriment of H ₂ production.	□ The microbial community structure and interactions were driven by HRT. □ LAB can be avoided at short HRT (6-12 h).	HPB consortium <i>Clostridiaceae</i> <i>Enterobacteriaceae</i> <i>Lachnospiraceae</i> LAB consortium <i>Sporolactobacillaceae</i> <i>Streptococcaceae</i>

^a HRT: Hydraulic retention time, h

^b VHPR: Volumetric hydrogen production rate, L/L-d

^c HY: hydrogen yield

Another important parameter worth to mention is the organic loading rate, which refers to the mass of substrate fed in a volume of reactor within a unit of time. OLR is function of both HRT and substrate concentration, thus the experiments performed for the present work also had different values of OLR; as lactose concentration was kept constant at 20 g_{lactose}/L OLR ranged from 80 g_{lactose}/L-d in CSTR2 to 20 g_{lactose}/L-d in CSTR5. It was observed that OLR decline was accompanied by the decreases of VHPR and H₂ yield (Table 2) confirming that these parameters are strongly dependent on HRT and OLR.

Table 2. Summary of the performance of four CSTR reactors operated at different values of HRT.

HRT, h	Time (No. of HRT)	VHPR mL/L-d	H ₂ yield, mol/mol	VFA concentrations, mmol/L						
				S	L	F	A	P	E	B
6	2	414.1	0.2	0.33	0	9.21	4	0	6.62	1.41
6	6	559.9	0.3	0.91	0	23.71	10.94	0	20.26	0.87
6	12	1035.1	0.3	0.31	0	13.58	7.74	0	11.33	1.59
6	20	2007.4	0.9	0	0	7.34	7.11	0	3.97	2.87
12	2	1049	0.3	0	0	18.51	11.21	0	19.69	8.1
12	6	1352.6	1	0	0	3.89	11.42	0	6.88	11.33
12	12	2382.3	0.8	0	5.57	2.41	11.92	1.23	2.71	9.49
12	20	1920.4	0.7	0	10.75	2.65	8.14	2.4	2.26	5.96
18	2	807.1	0.5	0	5.48	12.49	6.99	0	17.85	14.88
18	6	907.5	0.3	0	0.5	9.78	3.41	4.66	8.77	3.81
18	12	771.2	0.2	0	30.91	4.8	11.49	7.18	1.45	12.29
18	20	1061.6	0.2	0	33.28	1.5	12.47	14.63	0	22.06
24	2	331.8	0.1	0	113.01	0	9.38	5.67	6.51	32.73
24	6	532.3	0.1	0	88.1	0	3.78	3.89	7.29	30.27
24	12	432.3	0.1	0	76.61	0	4.83	3.2	7.69	29.41
24	20	604.2	0.1	0	160.86	0	0	0	0	18.4

Volatile Fatty Acids (VFA): S, Succinate; L, Lactate; F, Formate; A, Acetate; P, Propionate; E, Ethanol; B, Butyrate.

For comparison purposes, the higher values of each column are colored in deep blue (■) while lower values are displayed in white (□).

A Pearson's correlation analysis revealed that, in terms of metabolites productivities (mmol per mol of substrate consumed), longer HRT favored the lactate pathway ($r = 0.96$, $p < 0.01$).

In contrast, acetate was produced in higher proportion as well as other metabolites such as formate and ethanol under short HRT conditions ($r \sim -0.65$ for all cases, $p < 0.1$) (Figure 3).

The analysis also showed that these three metabolites were strongly correlated to each other ($r > 0.9$, $p < 0.05$). An overview of significant Pearson's correlations is provided in supplementary material. In general, the information confirmed that the HRT was an

effective factor that can shape DF towards two different stages: lactate type fermentation or acetate-formate-ethanol type fermentation.

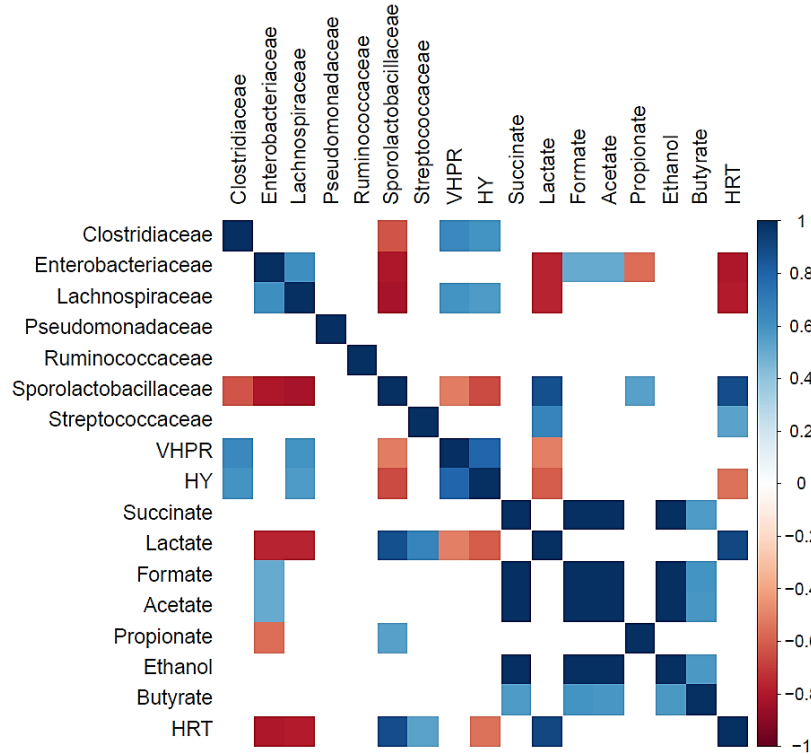

Figure 3. Matrix of Pearson's correlations obtained with the *corrplot* package in R environment. Only correlations with $p < 0.05$ are displayed. HY: H_2 yield ($\text{mol}_{H_2}/\text{mol}_{\text{Lactose}}$); VHPR: Volumetric hydrogen production rate ($L_{H_2}/L\cdot d$); Formate, Acetate, Propionate, Lactate, Butyrate, Ethanol, Succinate and Propionate were considered as production yields ($\text{mmol}/\text{mol}_{\text{Lactose}}$); HRT: hydraulic retention time (h). Microorganisms were analyzed in terms of their relative abundance from pyrosequencing results.

In addition, the COD-based analysis gives a clear overview of the metabolic shifts as consequence of the applied HRT (Figure 4). According to this analysis, a high percentage of substrate was directed to the synthesis of biomass and other unknown byproducts when HRT of 6, 12, and 18 h, were applied. Also, under such conditions, the percentage of substrate COD directed to H_2 was higher (8 and 6% COD basis) for HRT of 6 and 12h in

comparison with 18 and 24h (1 and 3% COD basis), suggesting that the metabolic network resulted in efficient H₂ production. This finding is consistent with relatively high yields of ethanol, acetate and butyrate, all of them being metabolically linked to H₂ production. In contrast at the longest HRT, 24h, most of the substrate (72% COD basis) ended as lactate.

VSS were experimentally determined, converted to COD using a theoretical equivalence of 1.42 gCOD/gSSV [2] and compared with COD percentages found for “biomass and others”, especially in the first three cases (51, 67 and 63%). Through this procedure, it was confirmed that COD directed to biomass were 44, 54.9, 59, and 59%, for HRT of 6, 12, 18 and 24h, respectively. Dark fermentative systems in CSTR have shown that about 30% of substrate is commonly directed to biomass, and in some cases, the percentage can reach near 50% of consumed COD. For instance, Jung et al. (2010) observed remarkable high biomass yields equivalent to 46% in a CSTR fed with the wastewater of a coffee drink manufacturer at a concentration of 20 gCOD/L and 6h of HRT [42]. Lay et al. (2010) also showed biomass yields that accounted for 38% in a CSTR fed with 40 gCOD/L molasses at an HRT of 24 h [43]. A possible reason of the high biomass yield can be that under short HRT (mainly 6 and 12 h), microorganisms directed a major fraction of the consumed substrate to maintain themselves in the system. If microorganisms do not direct an important fraction of COD to biomass synthesis under such conditions they would be washed out. There are other factors that possible influence the percentage of COD directed to biomass, for example the specific growth rate of microorganisms which will be discussed later in this document.

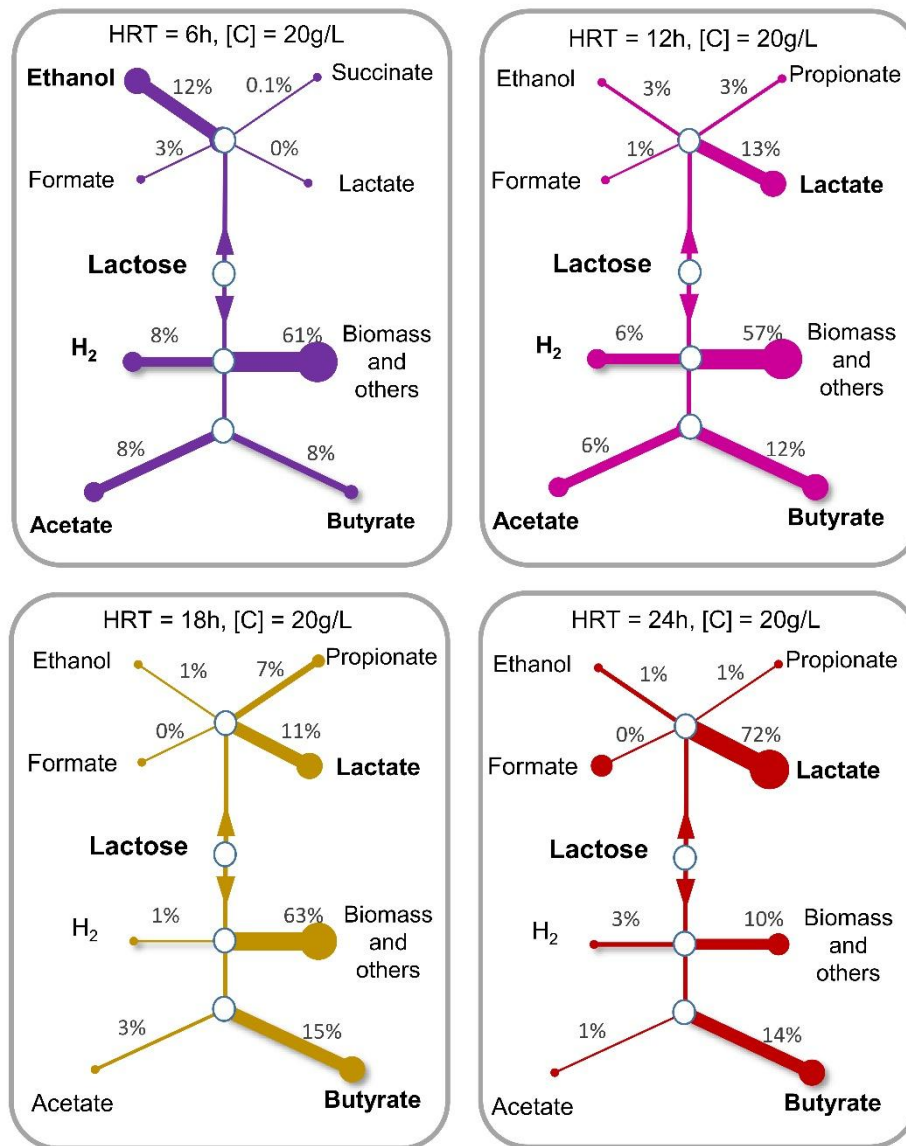

Figure 4. Summary of the influence of HRT on the metabolic pathways of dark fermentation based on COD. The COD balance was performed with the last 3 samples in the systems' operation.

3.2. HRT shapes the microbial community and modifies the metabolic pathways

A microbial community analysis through CE-SSCP was performed to characterize whether the changes towards high- or low-efficient states (described in previous section) was a consequence of metabolic shifts or changes in the microbial community structure. CE-

SSCP profiles comparison clearly show that HRT had a great impact on the microbial community with regards to the relative abundance distribution of species (Figure 5). For instance, microorganisms numbered 170 and 390 were dominant at HRT of 6h, while microorganisms at 560 and 690 were mainly present at HRT of 18 and 24h. These observations were confirmed with a Bray-Curtis dissimilarity analysis and the corresponding cluster dendrogram (hierarchical clustering using Ward's method) (Figure 5, left-side). SSCP profiles were successfully grouped according with the HRT, being samples from the CSTR2 mostly at the bottom of the graph while samples taken from CSTR5 were placed at the top. Interestingly, samples from CSTR3 and CSTR4 were distributed according with the sampling time, being samples taken after 2 and 6 equivalents of HRT placed at the bottom, while those taken after 12 and 20 equivalents of HRT were located at the top. Such tendency suggests that microbial communities were dynamic and changed as function of the time of operation.

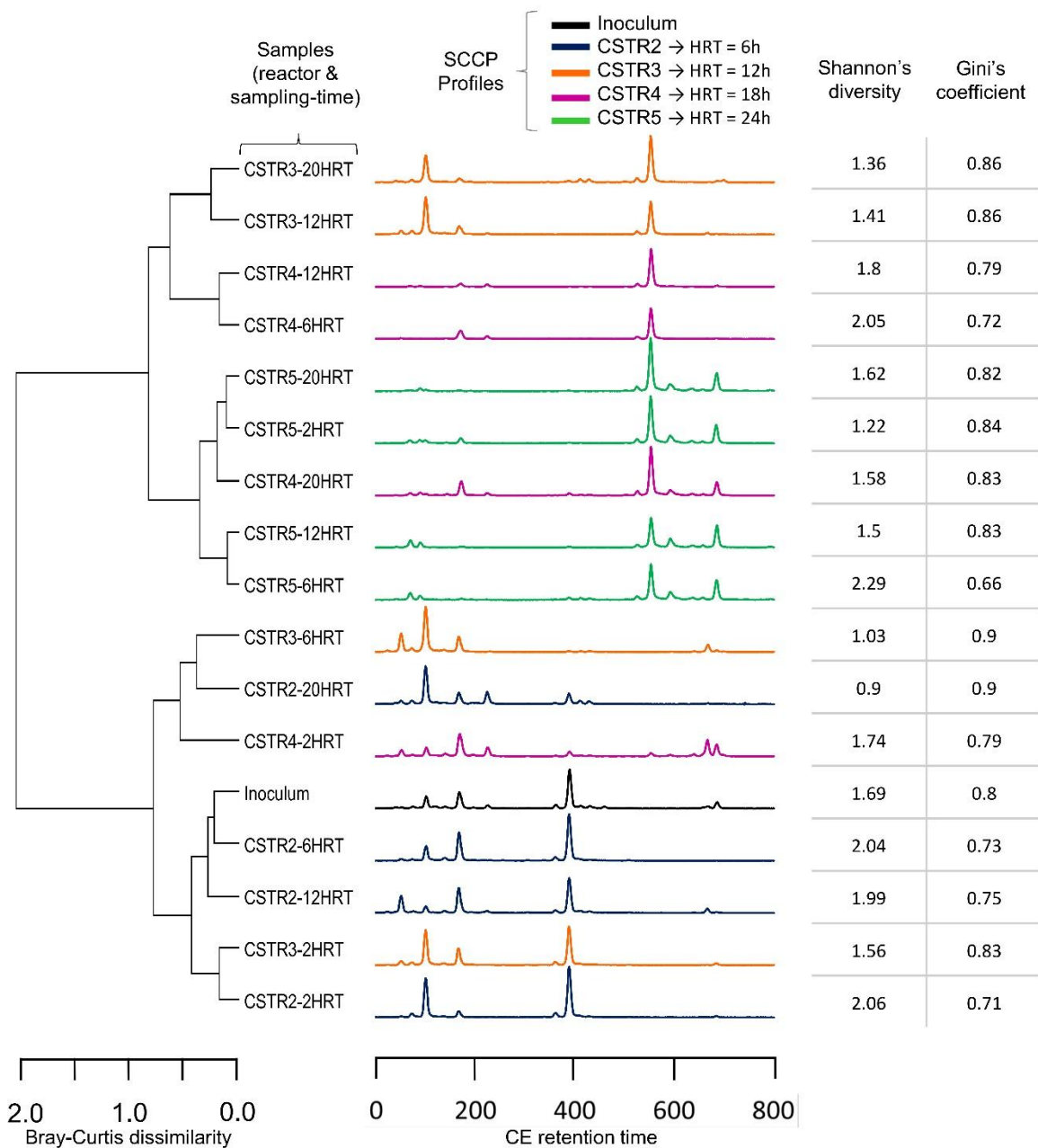

Figure 5. CE-SSCP fingerprints of samples from 4 CSTR operated under different HRT (6h, 12h, 18h and 24h). Note that 4 samples (after 2, 6, 12 and 20 HRT) were analyzed for each condition. The CE-SSCP profiles were processed to compute Bray-Curtis dissimilarities and hierarchical clustered. Shannon's diversity index and Gini's coefficients for evenness were computed for each profile as well.

Further analysis of the CE-SSCP profiles revealed microbial diversity Shannon's indexes of 1.6 ± 0.4 in average, which can be considered low but consistent with literature. For example, similar indexes were reported for a CSTR system fed with 15 g/L of galactose at an HRT of 12 h [44]. In contrast, values of the present work were lower than in granular systems. For instance, Cisneros-Pérez et al. (2015) reported Shannon indexes of 2.55 and 2.31 in two EGSB reactors operated about 96 days using heat shock and cell wash-out inocula, respectively [45]. These differences are probably related to the strong selection of suspended-cell system in comparison with fixed-cell systems, a feature that is widely known. Indeed, the high Gini coefficients indicates that the community was dominated by only few organisms which confirms the highly selective conditions of the CSTR systems.

Furthermore, 16S-rRNA gene sequencing resulted in 382 OTUs, identified to the genus level against the SILVA database. OTUs unsuccessfully identified with the SILVA database were instead compared with *NCBI Transcript Reference Sequences* through its online service (<https://blast.ncbi.nlm.nih.gov/Blast.cgi>). Overall, only 9 families showed a relative abundance higher than 1% and were considered for further analysis (Figure 6). These families were identified as *Clostridiaceae*, *Enterobacteriaceae*, *Sporolactobacillaceae*, *Lachnospiraceae*, *Ruminococcaceae*, *Streptococcaceae*, *Pseudomonadaceae* and *Flavobacteriaceae*. In most cases, the sum of 2 and 3 families accounted for $\geq 60\%$ and $\geq 80\%$ of relative abundance, respectively. Such uneven distribution, foreseen from CE-SSCP profiles, is consistently found in hydrogen-producing reactors [46].

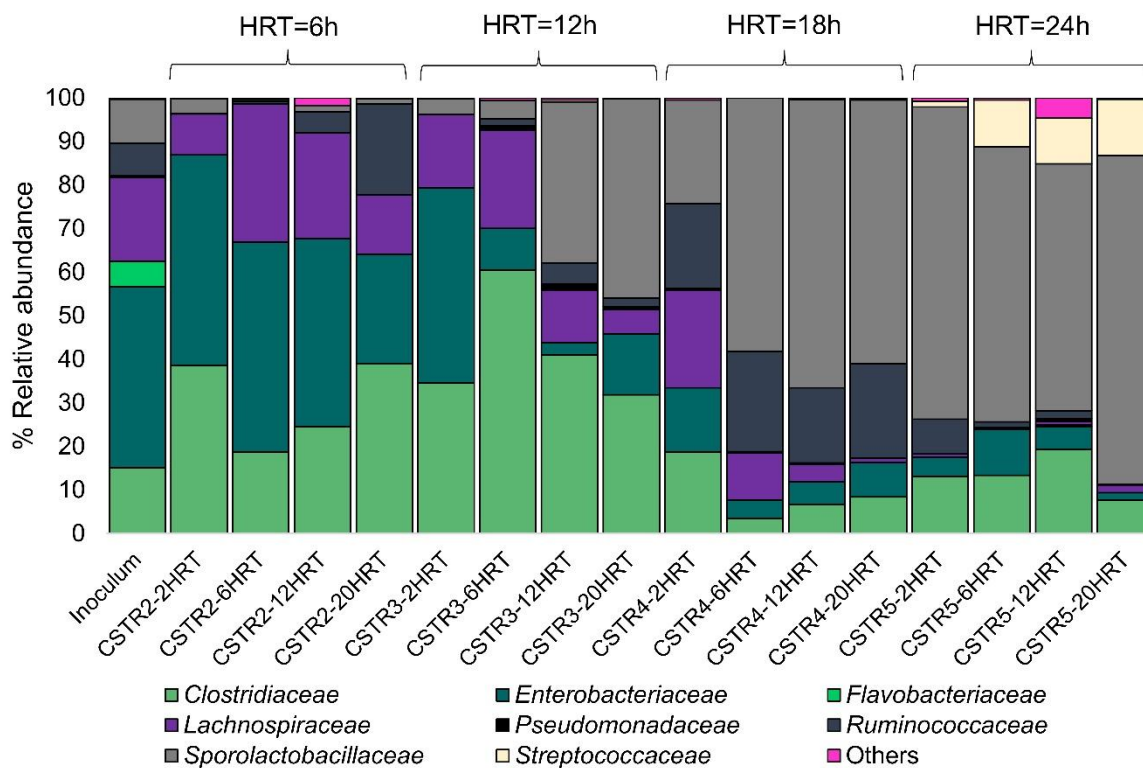

Figure 6. Relative abundance of bacteria families found from CSTR operated under different conditions of HRT (6h, 12h, 18h and 24h). For each reactor, four samples were taken in different moments of the operation (after 2, 6, 12 and 20 HRT). Families with relative abundance <1% were grouped as others.

Altogether, CE-SSCP (Figure 5) and sequencing results (Figure 6) confirmed that HRT was a very important factor of microbial community selection. In other words, HRT acted as pressure of selection, by eliminating the microorganisms incapable to duplicate at higher velocity than HRT. To illustrate this mechanism, at the lowest value of HRT (6h) only microorganisms with $\mu_{\max} > 0.115 \text{ h}^{-1}$ should remain, while at the highest HRT (24h) the minimum μ_{\max} would be 0.028 h^{-1} .

The changes observed among the microbial communities were consistent with growth rates reported for *Clostridiaceae* and *Enterobacteriaceae* bacteria, μ_{\max} of 0.5 and 4 h⁻¹, respectively [47,48]. In comparison, appreciably lower μ_{\max} of 0.1 h⁻¹ has been reported for a *Sporolactobacillaceae* members [49].

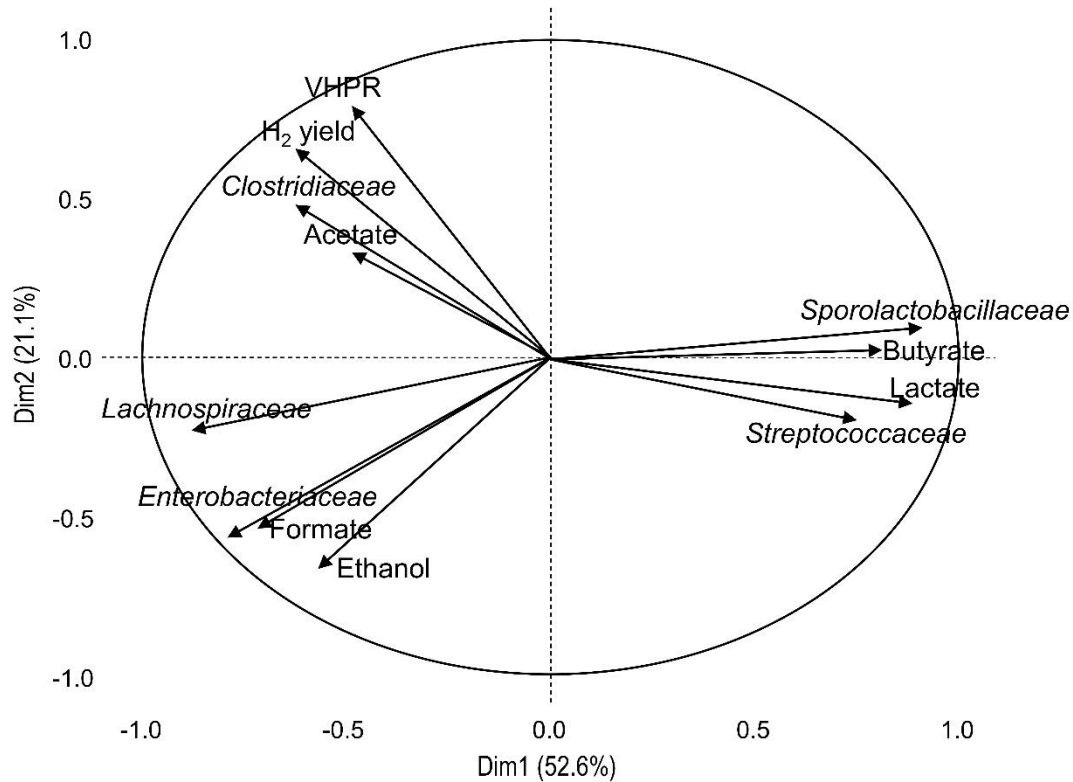

Figure 7. Principal Components Analysis for relative abundance of microbial families, metabolite yields (mmol/mol_{Lactose}) and hydrogen production performance (VHPR, mLH₂/L-d and HY, mol_{H₂}/mol_{Lactose}). Samples considered were taken at times equivalent to 2, 6, 12 and 20 HRT.

The variability in the relative abundance of microbial families, together with metabolites yields, and the reactor performance parameters were analyzed by principal components analysis with the aim to identify the relationships between the microbial groups and the

metabolic pathways (Figure 7).

It was confirmed that short HRT (6 and 12h) favored the dominance of OTUs related to the families *Clostridiaceae* and *Enterobacteriaceae*. In contrast, samples from CSTR with larger HRT (18 and 24h) were dominated by bacteria from the *Sporolactobacillaceae* and *Streptococcaceae* families.

The PCA analysis also confirmed that the organisms issued from the family *Clostridiaceae* were closely related to the acetate pathway and system performances in terms of VHPR and H₂ yield. At the genus level, this family was mainly composed of *Clostridium* species, which is in agreement with higher H₂ production as found in the literature [50].

Pathways leading to ethanol, formate and succinate were related to microorganisms from the *Lachnospiraceae* and *Enterobacteriaceae* families. In regard with *Enterobacteriaceae*, it is considered a family of hydrogen producers although, metabolically, the maximum yield would be 2 mol H₂ per mol of hexose consumed. Indeed, *Enterobacteriaceae* is associated with formate and ethanol production [51], which is in consistent with the PCA results. On the other hand *Lachnospiraceae* is a family known to much lesser extend in dark fermentative systems which has been associated to acetogenesis [50,52]. In our case this family was not significantly associated to acetate but more likely to production of succinate. Interestingly, *Lachnospiraceae* family has been observed in systems treating cheese whey as substrate with high percentage of lactose [53,54].

Moreover, lactate pathway was linked to the presence of bacteria belonging to *Sporolactobacillaceae* and *Streptococcaceae* families, confirming that system performance

under HRT of 24h was dominated by lactic-acid type fermentation. LAB have been widely found in dark fermentative systems but their implication remains controversial. In this study, longer HRT selected these organisms though reported μ_{\max} is about 0.1 h^{-1} [49]. This value of μ_{\max} was possible remarkably lower since they were not present until HRT of 18 h (equivalent $\mu_{\max} = 0.038 \text{ h}^{-1}$). Under such conditions LAB, specifically *Sporolactobacillaceae*, was a co-dominant group associated to the reduction of *Enterobacteriaceae* and *Clostridiaceae* which could be possible to the presence of bacteriocins as suggested in other studies [50].

In conclusion it was demonstrated that HRT is a critical factor of selection that determines the shape of DF microbial community and subsequently the global metabolism.

Overall, short HRT selected microbial communities rich in *Clostridiaceae-Lachnospiraceae-Enterobacteriaceae* specialized in acetate, ethanol and succinate pathways, and strongly linked to better hydrogen performances. On the contrary, long HRT selected *Sporolactobacillaceae-Streptococcaceae* families which are important LAB specialists in lactate synthesis.

3.3 A microbial interaction network displays an ecosystem dominated by mutual exclusive interactions

To identify the possible interactions existing among microorganisms in dark fermentative systems, a microbial network of interactions was constructed as described by Faust et al. [30]. The importance of this approach in the context of technology applicability relies on its possible utilization for the design of synthetic microbial communities [55] or

bioaugmentation strategies [56], which have been identified as alternatives to improve hydrogen productivities of DF. In both cases, it is necessary to identify the microbial groups, understand their capabilities and compatibilities with each other in order to successfully ensemble the desired community.

The resulting network (Figure 8) was composed by seven nodes corresponding to the families *Clostridiaceae*, *Enterobacteriaceae*, *Sporolactobacillaceae*, *Lachnospiraceae*, *Ruminococcaceae*, *Streptococcaceae*, and *Pseudomonadaceae* which were interconnected either positively or negatively by a total of thirteen edges. It is worth to note that more than 80% of the connections were mutual exclusive interactions, indicating that the microbial web was most probably dominated by competitive interactions rather than cooperation. Interestingly, the two edges that corresponded with positive correlations were the pairs *Sporolactobacillaceae*-*Streptococcaceae* (both LAB families) and *Enterobacteriaceae*-*Lachnospiraceae*.

In regard with the positive relationship found between the two LAB families, this connection suggests that a sort of cooperation could be taking place. According with metabolic information on *Sporolactobacillaceae* members, most of them are unable to process lactose [57]. Therefore, one possibility is that the organic carbon needed by *Sporolactobacillaceae* was provided by *Streptococcaceae* members or other organisms in the fermentation bulk, though the mechanism remains unclear.

As mentioned previously, the LAB families were predominant at relatively long HRT while *Enterobacteriaceae*, *Lachnospiraceae* and *Clostridiaceae* were dominant at low values of HRT. In this regard, the network analysis revealed that LAB had a strongly negative

interaction with *Enterobacteriaceae*, *Lachnospiraceae* and *Clostridiaceae* families. This finding supports the possible existence of outcompeting mechanisms of LAB that are detrimental to dark-fermentative groups.

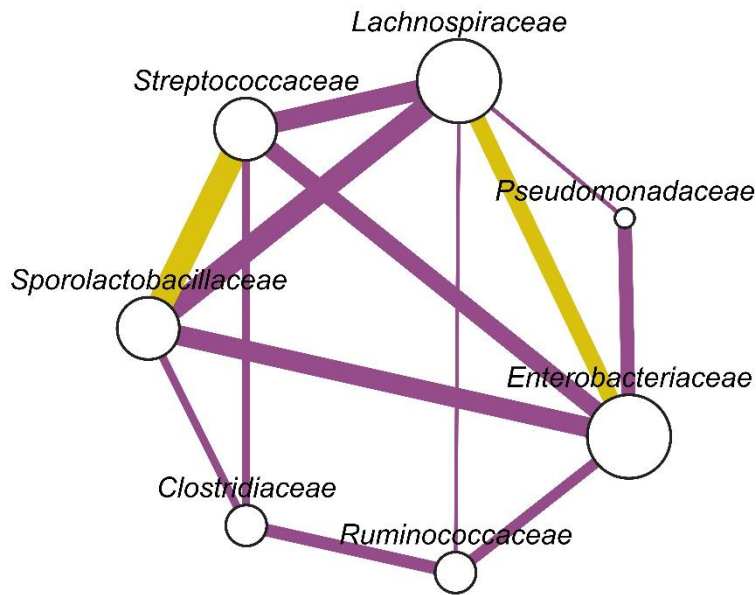

Figure 8. Network of interactions constructed from four different similarity measurements within Cytoscape environment, using the CoNet application (Faust and Raes, 2016). Only groups presented in at least three samples with > 1% relative abundance were considered. Edges represent strong connections ($p < 0.05$) between two microbial families (nodes). Yellow edges are positive interactions while purple edges represent a strong “exclusion” interaction. The width of the edges is shown proportional to the weight of the interaction between the microbial groups, while the size of the nodes is proportional to the number of interactions of the microbial group.

Altogether, the microbial network analysis indicates that two microbial community states

can be distinguished all along the experiments, resulting from a competition between a group composed of *Enterobacteriaceae*, *Lachnospiraceae* and *Clostridiaceae* members and LAB. It is worth to mention that the network analysis considers only unique and direct interactions and cannot predict any direction of the interaction nor connections of the type “when x and y are present, z is also present”. Therefore, other approaches are required to fully characterize the possible implications of LAB in dark fermentative systems.

4. Conclusions

The effect of HRT on shaping metabolic pathways and microbial communities in DF was successfully investigated. A maximum VHPR of 2000 mL/L-d corresponding to an H_2 yield of $0.86 \text{ mol}_{H_2}/\text{mol}_{\text{lactose}}$ was reached with 6h HRT. It was found that short HRT (6-12 h) correlated with hydrogen yield and led to microbial communities rich in *Clostridiaceae-Lachnospiraceae-Enterobacteriaceae* specialized in acetate-ethanol-formate pathways. Longer values of HRT (18-24 h) enriched the community in *Sporolactobacillaceae-Streptococcaceae* that strongly outcompeted HPB. Overall, it was demonstrated that HRT is a critical factor of selection that determines the shape of microbial community and global metabolism in DF.

5. Acknowledgements

This work was supported by the EU program BITA FP7-PEOPLE- 2011-IRSES, project 295170 about “Bioprocess and Control Engineering for Wastewater Treatment”. R. Palomo-Briones is grateful for the international mobility fellowship awarded by CONACYT-México. Special gratitude is also expressed to Clemence Pages and Gaele

Santa-Catalina for their technical assistance.

6. References

- [1] Azwar MY, Hussain M a., Abdul-Wahab AK. Development of biohydrogen production by photobiological, fermentation and electrochemical processes: A review. *Renew Sustain Energy Rev* 2014;31:158–73.
- [2] Rittmann BE, McCarty PL. *Environmental Biotechnology: Principles and Applications*. 2001.
- [3] Etchebehere C, Castelló E, Wenzel J, del Pilar Anzola-Rojas M, Borzacconi L, Buitrón G, et al. Microbial communities from 20 different hydrogen-producing reactors studied by 454 pyrosequencing. *Appl Microbiol Biotechnol* 2016:3371–84.
- [4] Ghimire A, Frunzo L, Pirozzi F, Trably E, Escudie R, Lens PNL, et al. A review on dark fermentative biohydrogen production from organic biomass: Process parameters and use of by-products. *Appl Energy* 2015;144:73–95.
- [5] Davila-Vazquez G, Cota-Navarro CB, Rosales-Colunga LM, de León-Rodríguez A, Razo-Flores E. Continuous biohydrogen production using cheese whey: Improving the hydrogen production rate. *Int J Hydrogen Energy* 2009;34:4296–304.
- [6] Han H, Jia Q, Wei L, Shen J. Influence of Cu²⁺ concentration on the biohydrogen production of continuous stirred tank reactor. *Int J Hydrogen Energy* 2014;39:13437–42.
- [7] Mäkinen AE, Nissilä ME, Puhakka JA. Dark fermentative hydrogen production from xylose by a hot spring enrichment culture. *Int J Hydrogen Energy* 2012;37:12234–40.

- [8] Sivagurunathan P, Sen B, Lin CY. High-rate fermentative hydrogen production from beverage wastewater. *Appl Energy* 2015;147:1–9.
- [9] Küsel K, Drake H. Acetogenic Clostridia. *Handb. Clostridia*, CRC Press; 2005, p. 719–46.
- [10] Luo G, Karakashev D, Xie L, Zhou Q, Angelidaki I. Long-term effect of inoculum pretreatment on fermentative hydrogen production by repeated batch cultivations: Homoacetogenesis and methanogenesis as competitors to hydrogen production. *Biotechnol Bioeng* 2011;108:1816–27.
- [11] Massanet-Nicolau J, Guwy A, Dinsdale R, Premier G, Esteves S. Production of hydrogen from sewage biosolids in a continuously fed bioreactor: Effect of hydraulic retention time and sparging. *Int J Hydrogen Energy* 2010;35:469–78.
- [12] Abubackar HN, Bengelsdorf FR, Dürre P, Veiga MC, Kennes C. Improved operating strategy for continuous fermentation of carbon monoxide to fuel-ethanol by clostridia. *Appl Energy* 2016;169:210–7.
- [13] Carrillo-Reyes J, Celis LB, Alatraste-Mondragón F, Razo-Flores E. Decreasing methane production in hydrogenogenic UASB reactors fed with cheese whey. *Biomass and Bioenergy* 2014;63:101–8.
- [14] Bakonyi P, Buitrón G, Valdez-Vazquez I, Nemestóthy N, Bélafi- Bakó K. A novel gas separation integrated membrane bioreactor to evaluate the impact of self-generated biogas recycling on continuous hydrogen fermentation. *Appl Energy* 2017;190:813–23.
- [15] Baghchehsaraee B, Nakhla G, Karamanev D, Margaritis A. Fermentative hydrogen production by diverse microflora. *Int J Hydrogen Energy* 2010;35:5021–7.

- [16] Kim DH, Jang S, Yun YM, Lee MK, Moon C, Kang WS, et al. Effect of acid-pretreatment on hydrogen fermentation of food waste: Microbial community analysis by next generation sequencing. *Int J Hydrogen Energy* 2014;39:16302–9.
- [17] Park J-H, Lee S-H, Ju H-J, Kim S-H, Yoon J-J, Park H-D. Failure of biohydrogen production by low levels of substrate and lactic acid accumulation. *Renew Energy* 2016;86:889–94.
- [18] Gomes SD, Fuess LT, Ma??unga T, Feitosa De Lima Gomes PC, Zaiat M. Bacteriocins of lactic acid bacteria as a hindering factor for biohydrogen production from cassava flour wastewater in a continuous multiple tube reactor. *Int J Hydrogen Energy* 2016;41:8120–31.
- [19] Noike T. Inhibition of hydrogen fermentation of organic wastes by lactic acid bacteria. *Int J Hydrogen Energy* 2002;27:1367–71.
- [20] Sikora A, Baszczyk M, Jurkowski M, Zielenkiewicz U. Lactic Acid Bacteria in Hydrogen-Producing Consortia: On Purpose or by Coincidence? *Lact. Acid Bact. - R D Food, Heal. Livest. Purp., InTech*; 2013.
- [21] Jo JH, Jeon CO, Lee DS, Park JM. Process stability and microbial community structure in anaerobic hydrogen-producing microflora from food waste containing kimchi. *J Biotechnol* 2007;131:300–8.
- [22] APHA/AWWA/WEF. *Standard Methods for the Examination of Water and Wastewater*. 2012.
- [23] Milferstedt K, Santa-Catalina G, Godon J-J, Escudié R, Bernet N. Disturbance Frequency Determines Morphology and Community Development in Multi-Species Biofilm at the Landscape Scale. *PLoS One* 2013;8:e80692.

- [24] Rochex A, Godon J, Bernet N, Escudier R. Role of shear stress on composition, diversity and dynamics of biofilm bacterial communities. *Water Res* 2008;42:4915–22.
- [25] R Development Core Team R. *R: A Language and Environment for Statistical Computing*. vol. 1. 2011.
- [26] Cabrol L, Malhautier L, Poly F, Lepeuple A-S, Fanlo J-L. Bacterial dynamics in steady-state biofilters: beyond functional stability. *FEMS Microbiol Ecol* 2012;79:260–71.
- [27] Kozich JJ, Westcott SL, Baxter NT, Highlander SK, Schloss PD. Development of a Dual-Index Sequencing Strategy and Curation Pipeline for Analyzing Amplicon Sequence Data on the MiSeq Illumina Sequencing Platform. *Appl Environ Microbiol* 2013;79:5112–20.
- [28] Carrillo-Reyes J, Trably E, Bernet N, Latrille E, Razo-Flores E. High robustness of a simplified microbial consortium producing hydrogen in long term operation of a biofilm fermentative reactor. *Int J Hydrogen Energy* 2016;41:2367–76.
- [29] Ramette A. Multivariate analyses in microbial ecology. *FEMS Microbiol Ecol* 2007;62:142–60.
- [30] Faust K, Lima-Mendez G, Lerat J-S, Sathirapongsasuti JF, Knight R, Huttenhower C, et al. Cross-biome comparison of microbial association networks. *Front Microbiol* 2015;6:1–13.
- [31] Faust K, Sathirapongsasuti JF, Izard J, Segata N, Gevers D, Raes J, et al. Microbial Co-occurrence Relationships in the Human Microbiome. *PLoS Comput Biol* 2012;8:e1002606.

- [32] Faust K, Raes J. CoNet app: inference of biological association networks using Cytoscape. *F1000Research* 2016;5:1519.
- [33] Zhang S, Lee Y, Kim T-H, Hwang S-J. Effects of OLRs and HRTs on hydrogen production from high salinity substrate by halophilic hydrogen producing bacterium (HHPB). *Bioresour Technol* 2013;141:227–32.
- [34] Diamantis V, Khan A, Ntougias S, Stamatelatou K, Kapagiannidis AG, Aivasidis A. Continuous biohydrogen production from fruit wastewater at low pH conditions. *Bioprocess Biosyst Eng* 2013;36:965–74.
- [35] Lee K-S, Tseng T-S, Liu Y-W, Hsiao Y-D. Enhancing the performance of dark fermentative hydrogen production using a reduced pressure fermentation strategy. *Int J Hydrogen Energy* 2012;37:15556–62.
- [36] Carrillo-Reyes J, Celis LB, Alatraste-Mondragón F, Razo-Flores E. Different start-up strategies to enhance biohydrogen production from cheese whey in UASB reactors. *Int J Hydrogen Energy* 2012;37:5591–601.
- [37] Rosa PRF, Santos SC, Sakamoto IK, Varesche MBA, Silva EL. Hydrogen production from cheese whey with ethanol-type fermentation: Effect of hydraulic retention time on the microbial community composition. *Bioresour Technol* 2014;161:10–9.
- [38] Sivagurunathan P, Kumar G, Bakonyi P, Kim SH, Kobayashi T, Xu KQ, et al. A critical review on issues and overcoming strategies for the enhancement of dark fermentative hydrogen production in continuous systems. *Int J Hydrogen Energy* 2016;41:3820–36.
- [39] Nualsri C, Kongjan P, Reungsang A. Direct integration of CSTR-UASB reactors for

two-stage hydrogen and methane production from sugarcane syrup. *Int J Hydrogen Energy* 2016;41:17884–95.

- [40] Wu S, Hung C, Lin C, Lin P, Lee K, Lin C, et al. HRT-dependent hydrogen production and bacterial community structure of mixed anaerobic microflora in suspended, granular and immobilized sludge systems using glucose as the carbon substrate. *Int J Hydrogen Energy* 2008;33:1542–9.
- [41] Zhang Z-P, Show K-Y, Tay J-H, Liang DT, Lee D-J, Jiang W-J. Effect of hydraulic retention time on biohydrogen production and anaerobic microbial community. *Process Biochem* 2006;41:2118–23.
- [42] Jung KW, Kim DH, Shin HS. Continuous fermentative hydrogen production from coffee drink manufacturing wastewater by applying UASB reactor. *Int J Hydrogen Energy* 2010;35:13370–8.
- [43] Lay C-H, Wu J-H, Hsiao C-L, Chang J-J, Chen C-C, Lin C-Y. Biohydrogen production from soluble condensed molasses fermentation using anaerobic fermentation. *Int J Hydrogen Energy* 2010;35:13445–51.
- [44] Sivagurunathan P, Kumar G, Park JH, Park JH, Park HD, Yoon JJ, et al. Feasibility of enriched mixed cultures obtained by repeated batch transfer in continuous hydrogen fermentation. *Int J Hydrogen Energy* 2016;41:4393–403.
- [45] Cisneros-Pérez C, Carrillo-Reyes J, Celis LB, Alatraste-Mondragón F, Etchebehere C, Razo-Flores E. Inoculum pretreatment promotes differences in hydrogen production performance in EGSB reactors. *Int J Hydrogen Energy* 2015;40:6329–39.
- [46] Etchebehere C, Castelló E, Wenzel J, del Pilar Anzola-Rojas M, Borzacconi L, Buitrón G, et al. Microbial communities from 20 different hydrogen-producing

reactors studied by 454 pyrosequencing. *Appl Microbiol Biotechnol* 2016;100:3371–84.

- [47] Chen W-M, Tseng Z-J, Lee K-S, Chang J-S. Fermentative hydrogen production with *Clostridium butyricum* CGS5 isolated from anaerobic sewage sludge. *Int J Hydrogen Energy* 2005;30:1063–70.
- [48] Tanisho S. *Hydrogen Production by Facultative Anaerobe Enterobacter aerogenes*. BioHydrogen, Boston, MA: Springer US; 1998, p. 273–9.
- [49] Zhao B, Wang L, Li F, Hua D, Ma C, Ma Y, et al. Kinetics of d-lactic acid production by *Sporolactobacillus* sp. strain CASD using repeated batch fermentation. *Bioresour Technol* 2010;101:6499–505.
- [50] Hung C-H, Chang Y-T, Chang Y-J. Roles of microorganisms other than *Clostridium* and *Enterobacter* in anaerobic fermentative biohydrogen production systems – A review. *Bioresour Technol* 2011;102:8437–44.
- [51] Hallenbeck PC, Ghosh D. Advances in fermentative biohydrogen production: the way forward? *Trends Biotechnol* 2009;27:287–97.
- [52] Denman SE, Fernandez GM, Shinkai T, Mitsumori M, McSweeney CS. Metagenomic analysis of the rumen microbial community following inhibition of methane formation by a halogenated methane analog. *Front Microbiol* 2015;6:1–12.
- [53] Davila-Vazquez G, de León-Rodríguez A, Alatraste-Mondragón F, Razo-Flores E. The buffer composition impacts the hydrogen production and the microbial community composition in non-axenic cultures. *Biomass and Bioenergy* 2011;35:3174–81.
- [54] Castelló E, García y Santos C, Iglesias T, Paolino G, Wenzel J, Borzacconi L, et al.

Feasibility of biohydrogen production from cheese whey using a UASB reactor: Links between microbial community and reactor performance. *Int J Hydrogen Energy* 2009;34:5674–82.

- [55] Faust K, Raes J. Microbial interactions: from networks to models. *Nat Rev Microbiol* 2012;10:538–50.
- [56] Kumar G, Bakonyi P, Kobayashi T, Xu KQ, Sivagurunathan P, Kim SH, et al. Enhancement of biofuel production via microbial augmentation: The case of dark fermentative hydrogen. *Renew Sustain Energy Rev* 2016;57:879–91.
- [57] Thamacharoensuk T, Kitahara M, Ohkuma M, Thongchul N, Tanasupawat S. *Sporolactobacillus shoreae* sp. nov. and *Sporolactobacillus spathodeae* sp. nov., two spore-forming lactic acid bacteria isolated from tree barks in Thailand. *Int J Syst Evol Microbiol* 2015;65:1220–6.