



HAL
open science

The interaction of soil phototrophs and fungi with pH and their impact on soil CO₂, CO₁₈O and OCS exchange

Joana Sauze, Jérôme Ogée, Pierre-Alain Maron, Olivier Crouzet, Virginie Nowak, Steven Wohl, Aurore Kaisermann, Samuel Jones, Lisa Wingate

► To cite this version:

Joana Sauze, Jérôme Ogée, Pierre-Alain Maron, Olivier Crouzet, Virginie Nowak, et al.. The interaction of soil phototrophs and fungi with pH and their impact on soil CO₂, CO₁₈O and OCS exchange. *Soil Biology and Biochemistry*, 2017, 115, pp.371-382. 10.1016/j.soilbio.2017.09.009 . hal-01608085

HAL Id: hal-01608085

<https://hal.science/hal-01608085>

Submitted on 26 May 2020

HAL is a multi-disciplinary open access archive for the deposit and dissemination of scientific research documents, whether they are published or not. The documents may come from teaching and research institutions in France or abroad, or from public or private research centers.

L'archive ouverte pluridisciplinaire **HAL**, est destinée au dépôt et à la diffusion de documents scientifiques de niveau recherche, publiés ou non, émanant des établissements d'enseignement et de recherche français ou étrangers, des laboratoires publics ou privés.



Distributed under a Creative Commons Attribution - NonCommercial - NoDerivatives 4.0 International License

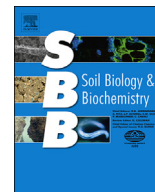

The interaction of soil phototrophs and fungi with pH and their impact on soil CO₂, CO¹⁸O and OCS exchange



Joana Sauze^{a,*}, Jérôme Ogée^a, Pierre-Alain Maron^b, Olivier Crouzet^c, Virginie Nowak^b, Steven Wohl^a, Aurore Kaisermann^a, Sam P. Jones^a, Lisa Wingate^a

^a ISPA, Bordeaux Science Agro, INRA, 33140 Villenave d'Ornon, France

^b Agroécologie, AgroSup Dijon, INRA, Univ. Bourgogne Franche-Comté, F-21000 Dijon, France

^c INRA, UR 251 PESSAC, Centre Versailles-Grignon, RD 10, 78026 Versailles Cedex, France

ARTICLE INFO

Article history:

Received 13 April 2017

Received in revised form

6 September 2017

Accepted 10 September 2017

Keywords:

Carbonic anhydrase

Fungi

Phototrophs

OCS

pH

Respiration

ABSTRACT

The stable oxygen isotope composition of atmospheric CO₂ and the mixing ratio of carbonyl sulphide (OCS) are potential tracers of biospheric CO₂ fluxes at large scales. However, the use of these tracers hinges on our ability to understand and better predict the activity of the enzyme carbonic anhydrase (CA) in different soil microbial groups, including phototrophs. Because different classes of the CA family (α , β and γ) may have different affinities to CO₂ and OCS and their expression should also vary between different microbial groups, differences in the community structure could impact the 'community-integrated' CA activity differently for CO₂ and OCS. Four soils of different pH were incubated in the dark or with a diurnal cycle for forty days to vary the abundance of native phototrophs. Fluxes of CO₂, CO¹⁸O and OCS were measured to estimate CA activity alongside the abundance of bacteria, fungi and phototrophs. The abundance of soil phototrophs increased most at higher soil pH. In the light, the strength of the soil CO₂ sink and the CA-driven CO₂-H₂O isotopic exchange rates correlated with phototrophs abundance. OCS uptake rates were attributed to fungi whose abundance was positively enhanced in alkaline soils but only in the presence of increased phototrophs. Our findings demonstrate that soil-atmosphere CO₂, OCS and CO¹⁸O fluxes are strongly regulated by the microbial community structure in response to changes in soil pH and light availability and supports the idea that different members of the microbial community express different classes of CA, with different affinities to CO₂ and OCS.

© 2017 The Authors. Published by Elsevier Ltd. This is an open access article under the CC BY-NC-ND license (<http://creativecommons.org/licenses/by-nc-nd/4.0/>).

1. Introduction

Changes in climate and land use could lead to a rapid release of terrestrial carbon (C) to the atmosphere in the near future, that may create a positive feedback of uncertain magnitude (Carvalho et al., 2014; Heimann and Reichstein, 2008). In order to constrain some of the uncertainties surrounding the fate of the C sink provided by the terrestrial biosphere, it is necessary to improve the representation of soil processes in land surface models. For this the C cycle research community is developing novel tools and independent tracers that will enable the detection of changes in carbon emissions and soil community function at large scales.

The oxygen stable isotope composition of atmospheric CO₂

($\delta^{18}\text{O}_a$) is one such tracer of biosphere fluxes at large scales (Cuntz, 2003; Francey and Tans, 1987; Welp et al., 2011; Wingate et al., 2009). This is because soil and leaf water pools carry very different isotopic compositions that are transferred to CO₂ fluxes during leaf photosynthesis and soil respiration under the action of a family of enzymes called carbonic anhydrase (CA), ubiquitous in plants and soil micro-organisms (Badger, 2003; Moroney et al., 2001; Smith and Ferry, 2000). However, the partitioning of leaf and soil CO₂ fluxes using $\delta^{18}\text{O}_a$ hinges on our understanding of how CA activity varies in different members of the soil community and across the land surface (Welp et al., 2011; Wingate et al., 2009). Wingate et al. (2009) demonstrated that the CA-catalysed oxygen isotope exchange rate in soils from different biomes was between 20 and 300 times faster than the un-catalysed rate. These rates of soil CA activity have recently been supported by another study modelling the hydrolysis of carbonyl sulphide (OCS) by CA and the net exchange of OCS between different soil types and the

* Corresponding author. INRA, UMR 1391 ISPA, 71 avenue Édouard Bourlaux, CS 20032, 33182 Villenave d'Ornon Cedex, France.

E-mail address: joana.sauze@inra.fr (J. Sauze).

atmosphere (Ogée et al., 2016). This is an important and promising finding as OCS has emerged recently as another independent and promising tracer of gross CO₂ fluxes at large scales (Campbell et al., 2008; Montzka et al., 2004; Sandoval-Soto et al., 2005). However, it still remains unclear whether the diversity of CAs present in soils has an impact on the soil CA activity for OCS and CO₂, and to the same extent for both tracers. For example the dominant CAs in bacteria and fungi are those from the β class (Elleuche and Poggeler, 2010; Smith and Ferry, 2000; Smith et al., 1999) whilst algae and cyanobacteria express both α-CAs on their periplasmic membranes (Moroney et al., 2001) and β-CAs in their cytoplasm, chloroplasts and mitochondria. Furthermore, these different classes of CA can have different affinities to the substrates CO₂ and OCS (Haritos and Dojchinov, 2005; Kamezaki et al., 2016; Ogawa et al., 2013; Ogée et al., 2016) that may or may not change with soil pH (Notni et al., 2007; Rowlett et al., 2002). So far very little work has explored how the soil community structure influences the soil CA activity for OCS and CO₂.

Li et al. (2005) and subsequently Wingate et al. (2009) hypothesised that spatial variability in CA activity for CO₂ could be caused either by variations in the intrinsic activity of certain soil microbial groups and/or linked to shifts in soil community structure between biomes. In particular, soil eukaryote algae are generally much larger organisms (100 μm³) than bacteria (1 μm³) and are likely to contain higher concentrations of both intra- and extra-cellular CA (Coleman et al., 1984; Hopkinson et al., 2013; Moroney et al., 2001; Palmqvist and Badger, 1996; Sültemeyer, 1998). Algae are also most abundant at the soil surface (Bristol-Roach, 1927; John, 1942; Metting, 1981) where rapid equilibration of δ¹⁸O_a with soil water also occurs (Wingate et al., 2010, 2009, 2008). On the other hand, the number of algae (10⁶ g⁻¹ dry soil) found at the soil surface is still generally out-numbered by bacterial and to a lesser extent fungal populations (typically 10⁹ g⁻¹ dry soil). In addition, soil pH is an important controlling factor of the abundance and diversity of algal (Lund, 1947; Shields and Durrell, 1964; Stokes, 1940), bacterial (Fierer and Jackson, 2006; Griffiths et al., 2011; Lauber et al., 2009) and fungal (Rousk et al., 2010; Tedersoo et al., 2014) communities, thus the variations in CA activity observed by Li et al. (2005) and Wingate et al. (2009) may also partially reflect pH-driven variations in the relative abundance of microbial groups at the soil surface as well as the activity of CA.

Irrespective of their role in the δ¹⁸O_a signal, photoautotrophic micro-organisms (*i.e.* algae and cyanobacteria referred to hereon as phototrophs) are important players in the C and nitrogen (N) cycles, especially in dryland ecosystems (Belnap and Lange, 2003; Bowker et al., 2010; Castillo-Monroy et al., 2011). A number of studies focused on biological and microbiological soil crusts have pinpointed key roles of fungi and cyanobacteria in their function (Lan et al., 2015; Maestre et al., 2010). However there are very few studies that have investigated all of the photosynthetic micro-organisms present in soil biocrusts (*i.e.* cyanobacteria and algae, Schmidt et al., 2011) at the same time as bacteria and/or fungi (Bates and Garcia-Pichel, 2009; Lee et al., 2012; Nagy et al., 2005). This is also a similar situation for studies on temperate agricultural soils where there is a growing body of literature on fungal and bacterial community interactions but far fewer studies investigating the role of eukaryotic algae, despite evidence for their colonisation on agricultural soil surfaces (Metting, 1981; Zancan et al., 2006). For example, it has been known for some time that variations in the abundance of phototrophs in soils can set-up 'ecological ripples' by improving soil fertility and crop productivity (Evans and Johansen, 1999; Shields and Durrell, 1964) at the same time as contributing an important functional role to the sequestration of soil C and N at the global scale (Castillo-Monroy et al., 2011; Elbert et al., 2012).

A number of recent studies have also indicated that soils from a range of biomes are capable of fixing CO₂ at different depths in the soil profile (Goyal, 1997; Hart et al., 2013; Nowak et al., 2015; Šantrůčková et al., 2005; Yuan et al., 2012). So far the attribution of CO₂ fixation in soils by phototrophic organisms is currently supported by observed changes in the abundance of marker genes encoding for RuBISCO (Nowak et al., 2015) but heterotrophic CO₂ fixation by bacteria and algae may also occur (Šantrůčková et al., 2005). Indeed complex relationships between phototrophs and other microbial partners often arise as phototrophs can excrete a large variety of substances including enzymes, organic acids and polysaccharides (Metting, 1981) into their surroundings that allow bacterial and fungal partners to grow. Phototrophs also contribute to the initiation of microbial mats that develop over time by recruiting other microbial partners (Flemming et al., 2016; Konopka et al., 2015; Thompson et al., 2015). However, as far as we are aware, no study to date has determined how changes in the net soil CO₂ efflux and other GHG tracers such as OCS are regulated by changes in the abundance of phototrophic (algae and cyanobacteria) and heterotrophic (bacteria and fungi) microbial groups in natural soils varying in pH. This is mainly because the tools to address these functional relationships are generally time-consuming (dilution counts) or indirect (pigment analysis). Furthermore, assessment of the soil photosynthetic microbial community often requires the implementation of different molecular tools (Schmidt et al., 2011). Consequently, soil microbial ecology often overlooks the entire phototrophic microbial community, despite growing evidence of their important ecological role in gas exchange, soil fertility and soil aggregation.

In this context we set out to investigate how the contribution of soil phototrophs and heterotrophs impacted the net exchange of atmospheric CO₂ and OCS with soils. We questioned how changes in the abundance of microbial groups altered the CA activity of soils for both tracers, and how changes in the soil community structure and function would be altered by soil pH. In particular, we set out to test the hypotheses that increasing soil pH would favour the development of soil phototrophs and that, as the abundance of phototrophs increased in soils, the sink strength for CO₂ and OCS as well as the associated CA activities would also increase. However, we hypothesised that the behaviour of the two trace gases across all soil types would diverge between light and dark periods as emissions of CO₂ would increase in the dark because of an increase in respiratory metabolism, whilst OCS exchange rates would remain unchanged as CA is considered to be a light-independent enzyme (Gimeno et al., 2017; Protoschill-Krebs et al., 1996).

2. Material and methods

2.1. Soil sampling and conditioning

Four soils were sampled from different field sites ensuring a wide range of pH values (4.6–8.1) (Table 1). According to the FAO World Reference Base for soil classification (IUSS Working Group WRB, 2006), Le Bray (LB) is a podzol with an organic, sandy A horizon sampled from a coniferous forest located 20 km from Bordeaux during February 2016. Lacage (LG) is a luvisol with a silty loam A horizon sampled from an INRA experimental field growing a wheat-alfalfa rotation located in Versailles during April 2016. Pierrelaye (DBZ) is a luvisol with a sandy A horizon sampled from an INRA experimental field growing a corn-wheat rotation located 30 km from Paris during December 2015. Finally Toulonne (TL) is a fluvisol sampled from an INRA experimental orchard growing cherry and peach trees located 50 km from Bordeaux during February 2016.

At each location three spatially-independent soil samples were

Table 1

Main characteristics of the different soils used for the study.

	Le Bray (LB)	La Cage (LG)	Pierrelaye (DBZ)	Toulonne (TL)
Land use	pine plantation	cropland	cropland	cropland
pH	4.6	6.3	7.0	8.1
Sand content (g kg ⁻¹)	947	184	822	167
Silt content (g kg ⁻¹)	26	647	87	523
Clay content (g kg ⁻¹)	27	169	91	310
C/N ratio	26.0	10.4	13.9	10.4

taken from the surface horizon 0–10 cm. Composite soil samples for each location were sieved with a 5 mm mesh and mixed to reconstitute one homogenised soil sample. For each soil the maximum water holding capacity (WHC) was estimated on three replicates following the method of [Haney and Haney \(2010\)](#). Thereafter for each soil, six microcosms were prepared, consisting of 350–400 g of fresh soil re-packed in a 0.825 dm³ glass jar. Each soil was then weighed and maintained at 80% of its maximum WHC to encourage the development of native soil phototrophs. Each microcosm was sealed with Parafilm M[®] to minimise evaporation, and incubated in a climate-controlled room at 20 °C for forty days. At the start of the incubation three of the six microcosms were coated with aluminium foil (Dark Conditioning or DC) to inhibit the development of phototrophic organisms whilst the other three microcosms were conditioned under a day/night cycle (Light Conditioning or LC) consisting of a 16 h light/8 h dark photoperiod using LED lighting with an intensity of about 500 μmol(photons) m⁻² s⁻¹ in the visible range to promote the growth of the native phototrophic flora ([Fig. 1](#)). During the incubation period the jars were periodically opened two times a week to refresh the air in the microcosm headspace.

2.2. Gas exchange experimental setup

After forty days, the aluminium covers were removed from the three dark conditioned microcosms and a self-contained thermocouple datalogger (iButton, DS1923, Embedded Data Systems, Lawrenceburg, KY, US) was positioned at the top of each soil column to measure the humidity and temperature at the soil surface. Each microcosm was then sealed with a customised glass lid fitted with two stainless steel Swagelok[®] bulkhead fittings connected to 0.25 inch (3.175 mm) Teflon[™] inlet and outlet lines to form a flow-through gas exchange chamber. The six soil microcosms were then placed in a customised climate-control chamber (MD1400, Snijders, Tillburg, NL) to acclimate at 25 °C with the lights on. An additional soil-free glass jar containing an iButton was also sealed and connected to a set of lines in the climate-control chamber in order to check that our setup was free of any OCS contamination.

During the gas exchange measurements, air was supplied to each of the microcosms using a compressor (FM2 Atlas Copto, Nacka, Sweden), coupled to a chemical scrub column (Ecodyr K-MT6, Parker Hannifin, Cleveland, OH, US) that first removed water vapour, CO₂ and OCS from ambient air in the lab. Concentrations in the scrubbed airstream were typically less than 5 μmol(CO₂) mol⁻¹, 7 pmol(OCS) mol⁻¹ and -40 °C dew point. A set of individual mass flow controllers (MFC, EL-Flow[®] Select, Bronkhorst, Ruurlo, NL) and stainless steel cylinders containing either pure CO₂ or CO₂-free dry air with 500 nmol(OCS) mol⁻¹ (Linde, France) were then used to supply CO₂ and OCS to the air stream in a 4L aluminium buffer and reach concentrations around 420 μmol(CO₂) mol⁻¹ (420 ppm) and 1000 pmol(OCS) mol⁻¹ (1000 ppt). The (dry) air supplied to the inlet of each microcosm was taken from this buffer volume at a flow rate of 0.25 dm³ min⁻¹ ([Fig. S1](#)). The flow from the buffer volume to the microcosms was driven by a slight overpressure in the buffer of

20–30 mbar above atmosphere. Within a single flux measurement, the standard deviation on the inlet was less than 0.03 ppm(CO₂) and 1.5 ppt(OCS).

2.3. CO₂ mixing ratio and stable isotopes measurements (TDLAS)

The airstreams for a given microcosm were selected for CO₂ measurements by means of an 8-way solenoid (BX 758.8E1C312, 0–4 bar, Matrix, Italy). The airstream passed through a Nafion dryer (MD-40 Perma pure Inc., NJ, USA) before being analysed for its ¹²C¹⁶O₂, ¹³C¹⁶O₂ and ¹²C¹⁸O¹⁶O concentrations (TGA100A, Campbell Scientific Inc., Logan Utah, USA). Laser emission on the absorption lines was maintained using a reference gas of 25% CO₂-in-air (Linde, France). Flow through the instrument was maintained with a diaphragm vacuum pump (KNF N940, Neuberger, UK Ltd, UK) connected to the TGA100A via a vacuum line and excess air was exhausted to the atmosphere ([Fig. S1](#)). Calibration was performed every 16 min using 3 aluminium calibration tanks containing CO₂-in-air (Deuste-Steininger, Germany) spanning a CO₂ concentration range (374.9 ± 1.9, 474.6 ± 2.4 and 687.1 ± 4.0 ppm) and similar δ¹⁸O values (-14.68 ± 0.01, -14.70 ± 0.03 and -14.68 ± 0.03‰ VPDB-CO₂). Calibration tank gas was precisely characterised at the MPI for Biogeochemistry (Jena, Germany). A series of Allan variances indicated a standard deviation of 0.1 μmol(CO₂) mol⁻¹ and 0.3‰ for δ¹³C and δ¹⁸O after 10s of averaging time. Calibration tank measurements were linearly interpolated in time and a calibration regression was performed as described in [Wingate et al. \(2010\)](#).

2.4. OCS mixing ratio measurements (QCLS)

Microcosm airstreams were selected for OCS measurements by means of a 12-way rotary valve (EUTA-SD16WE VICI[®] 16 positions two way valve, Valco Instruments Co. Inc, Texas, USA). The airstream was pre-dried with a Nafion[™] drier (MD-070-24-S-2, Perma Pure LLC, NJ, USA) before being measured (QCLS, Aerodyne Research Inc. Billerica, MA, USA). Flow was maintained with a TriScroll 600 pump (Agilent Technologies, Santa Clara, CA, USA) connected to the QCLS via a vacuum line and excess air was exhausted to atmosphere. Instrument drift was corrected with frequent (every 16 min) background calibrations (with dry N₂) in all runs. After 12 min of measurements, a 4-min, two-point standard calibration was also implemented using the same dry N₂ bottle and compressed dry air from an Aculife[®]-treated cylinder with a known OCS concentration (524.8 ± 2.2 ppt) prepared and calibrated for OCS by the NOAA Global Monitoring Division. An Allan variance calculated from a 24 h continuous measurement on tank air indicated a standard deviation of 2.1 ppt(OCS) after 10 s averaging time.

2.5. Sampling sequence

Microcosm airstreams and calibration tanks were scanned at 1 Hz over 2 min and the last 20s used to compute the mean concentrations. In a sequence, seven chambers (the six soil-filled microcosms and a blank chamber) were scanned sequentially by the

(a) Growth conditions: 80% of the WHC and 20°C

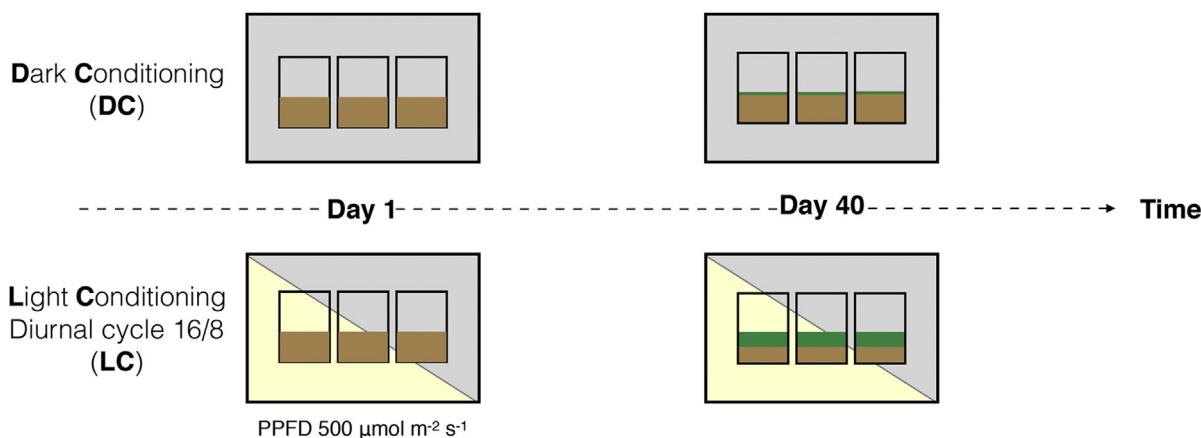

(b) Gas-exchange (CO₂, CO¹⁸O and OCS) measurement conditions: 80% of the WHC and 25°C

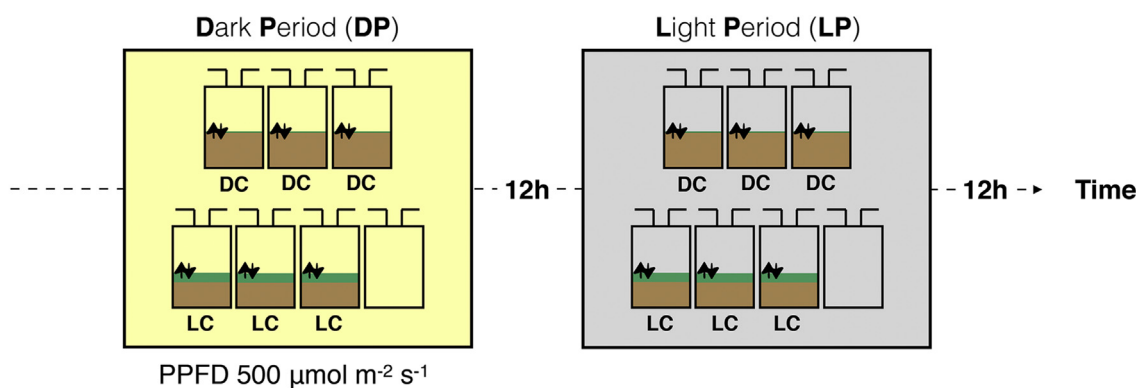

Fig. 1. Diagram illustrating the two-incubation treatments (applied from day 1 to day 40) and the two measurement treatments applied during the following 24 h of gas exchange measurements of the six microcosms from a given soil. DC: Dark Conditioning, LC: light conditioning, DP: dark period, LP: light period, WHC: water holding capacity, PPFD: photosynthetic photon flux density.

OCS and CO₂ isotope analysers and, when not measured, were continuously flushed at the same constant flow rate. The full sequence of gas exchange measurements lasted 24 h and combined light (LP) and dark (DP) periods and two different inlet CO₂ isotopic compositions (using two different pure CO₂ bottles, see Fig. S1). The first 12hrs of gas exchange were completed with the lights on (LP) providing a light intensity of 500 μmol(photons) m⁻² s⁻¹ in the visible range (Fig. 1). The subsequent 12hrs of gas exchange were then completed in the dark (DP).

2.6. Calculating fluxes and CA activity

The OCS and CO₂ fluxes were computed assuming steady-state conditions:

$$F = \frac{u_{in}}{S} (C_{out} - C_{in}) \quad (1)$$

where u_{in} is the flow rate of dry air through the chamber (mol s⁻¹), S is the soil surface (m²) and c_{in} and c_{out} are the mixing ratios of OCS or total CO₂ (mol mol⁻¹) in the air entering and leaving the chamber respectively. Because these mixing ratios were determined on a dry air basis (because of Nafion dryer upstream of each analyser) only the flow of dry air on the inlet of the chamber was needed. For each microcosm, the three replicates of inlet/outlet

pairs gave three individual values of the OCS and CO₂ fluxes from which a mean and standard deviation could be computed. The mean OCS flux from the blank (empty) chamber was always not significantly different from zero (Fig. S2), indicating that our experimental setup was free of any OCS contamination.

Under steady-state conditions, the fluxes of ¹²C¹⁶O₂ (¹⁶F) and ¹²C¹⁸O (¹⁸F) can also be computed using Eq. (1), and the oxygen isotopic signature of the soil CO₂ flux ($^{18}\delta_F = 0.5^{18}F/^{16}F/R_{std} - 1$, expressed relative to the isotope ratio R_{std} of the VPDB-CO₂ standard) can thus be calculated from the ¹²C¹⁶O₂ mixing ratios and $\delta^{18}O$ of the inlet (¹⁶c_{in}, ¹⁸δ_{in}) and outlet (¹⁶c_{out}, ¹⁸δ_{out}) air:

$$^{18}\delta_F = \frac{^{16}C_{out} \ ^{18}\delta_{out} - ^{16}C_{in} \ ^{18}\delta_{in}}{^{16}C_{out} - ^{16}C_{in}} \quad (2)$$

For each steady state three replicates of the inlet and outlet were obtained leading to three individual values of ¹⁸δ_F from which a mean and standard deviation could be computed.

Soil carbonic anhydrase activity was then calculated, either in the form of OCS hydrolysis rate (k_h) or CO₂-H₂O isotopic exchange rate (k_{iso}). The OCS hydrolysis rate k_h was estimated following Ogee et al. (2016). According to their Eq. (16b), and assuming no OCS source from the soil microcosm, the OCS flux F_S estimated with Eq. (1) is directly related to k_h :

$$F_s = \sqrt{k_h B_s \theta D_s C_s} \tanh\left(\frac{z_s}{2z_{\max}}\right) \quad (3)$$

where B_s , D_s , C_s represent respectively the OCS solubility in soil water ($\text{m}^3 \text{m}^{-3}$), the OCS effective diffusivity through the soil column ($\text{m}^2 \text{s}^{-1}$) and the gaseous OCS concentration at the soil-air interface (mol m^{-3}), z_{\max} is maximum soil depth and z_s is a characteristic depth above which diffusion of OCS out of the soil becomes faster than OCS hydrolysis: $z_s = (D_s/k_h B_s \theta)^{1/2}$ (Ogée et al., 2016). The solubility B_s is only a function of temperature while D_s is a function of temperature, soil moisture and porosity, and the formulation of Moldrup et al. (2003) for repacked soils was used. Assuming well-mixed conditions in the chamber we have $C_s = c_{out} p/8.31441/T$ where p (Pa) and T (K) are the air pressure and temperature inside the headspace. Equation (3) was then solved iteratively for the OCS hydrolysis rate k_h .

Using a similar approach as in Tans (1998) or Wingate et al. (2010) but accounting for the finite depth z_{\max} of our soil microcosms, we were also able to relate the CO_2 - H_2O isotopic exchange rate k_{iso} (s^{-1}) to $^{18}\delta_{\text{F}}$:

$$^{18}\delta_{\text{F}} = \delta_{\text{eq}} + \varepsilon_D \left(1 - \frac{z_c}{z_{\max}} \tanh\left(\frac{z_{\max}}{z_c}\right)\right) + \frac{k_{\text{iso}} B_c \theta D_c C_c}{F_c} (\delta_{\text{eq}} - \delta_a) \tanh\left(\frac{z_{\max}}{z_c}\right) \quad (4)$$

where B_c , D_c , C_c , F_c and z_c are the counterparts of B_s , D_s , C_s , F_s and z_s for CO_2 , δ_a is the $\delta^{18}\text{O}$ of CO_2 at the soil-air interface (assumed equal to $^{18}\delta_{\text{out}}$) and δ_{eq} is the CO_2 isotopic composition of CO_2 in equilibrium with soil water. The latter was measured after each gas exchange measurement (see below) so that Eq. (4) could be solved iteratively to retrieve k_{iso} from $^{18}\delta_{\text{F}}$ measurements. Note that Eq. (4) is not strictly valid in our case because it assumes uniformity of CO_2 production, soil moisture, porosity, temperature, k_{iso} and δ_{eq} throughout the soil column, and no CO_2 consumption. Care was taken to homogenise the soil microcosms prior to their incubation and to maintain a constant soil water content during the incubation but the day/night cycle imposed on half of them helped developed soil phototrophs at the soil surface that clearly challenged the validity of Eq. (4). Theoretically we could account for their presence and derive another equation but, in practice, this would introduce extra parameters that would be difficult to estimate. We thus preferred to use Eq. (4) for all our microcosms and the retrieved k_{iso} will be considered below as an apparent CO_2 - H_2O isotopic exchange rate, related to some extent to soil CA activity for CO_2 .

2.7. Soil community analyses

Immediately after gas exchange measurements, material from the soil surface (0–2 cm) was sampled from each microcosm and stored in the dark at -80°C before being freeze-dried. Microbial DNA was extracted from 1 g of soil from each triplicate microcosm of each treatment as previously described (Plassart et al., 2012; Terrat et al., 2012). DNA concentrations of crude extracts were determined by electrophoresis in a 1% agarose gel using a calf thymus DNA standard curve, and used as estimates of microbial molecular biomass (Dequiedt et al., 2011). After quantification, DNA was purified using a PVPP column (Sigma Aldrich, Saint-Louis, USA) and GENECLEAN turbo kit (Mpbio, Illkirch, France). Bacterial, fungal and phototroph (algae and cyanobacteria) abundances were estimated using the number of copies measured for 16S-, 18S- and plastidial 23S-rDNA genes, respectively, by qPCR using a StepOne[®] Real-Time PCR System (Applied Biosystems, Courtaboeuf, France) with a SYBRGreen[®] detection system and primer sets defined

previously (Chemidlin Prévost-Bouré et al., 2011; Plassart et al., 2012; Sherwood and Presting, 2007).

2.8. Soil water oxygen isotope composition

Immediately after the gas exchange measurements material from different soil depths (0–2, 2–4 and 4–6 cm depth) was sampled from each microcosm and stored at 5°C before cryogenic vacuum distillation. Distilled waters were then analysed for $\delta^{18}\text{O}$ composition (LWIA-45EP, Los Gatos Research Inc., San Jose, California, USA).

2.9. Statistical analyses

All statistical analyses were performed with the R software package (R3.1.3, R Core Team, 2015). Mixed effect linear models (lme in nlme package, Pinheiro et al., 2015) allowed to assess how soil conditioning (DC or LC) and physicochemical properties (texture and pH) influenced the bacterial, fungal and phototroph abundances. Soil conditioning (DC or LC) and measurement type (DP or LP), soil type (LB, LG, DBZ, TL) and their interactions were taken as fixed effects and replicates as a random effect. Mixed effects linear models were also used to test whether the CO_2 and OCS fluxes as well as their associated CA activity (k_{iso} and k_h) were related to the abundance of photosynthetic microorganisms.

3. Results

3.1. Effect of conditioning on the abundances of microbial groups

The development of green mats in the microcosms incubated under a diurnal cycle (LC treatment) were observed by the naked eye after forty days on three of our soils (LG, DBZ and TL), but not on the most acidic soil (LB) or any soil that had been incubated in the dark (DC treatment). The qualitative indications of the visual observations were supported by the qPCR data (Fig. 2). An overall increase in the number of 23S rDNA gene copies, a proxy for the abundance of photosynthetic microorganisms, was found in all the LC-incubated microcosms relative to the DC-incubated microcosms, but not significantly in the most acidic soil (LB). The largest increases in phototrophs abundance were observed on the high pH soils (DBZ and TL), whereas the smallest change in abundance occurred on the acidic, and less green, soil (LB). In all soils where phototrophs abundance increased significantly (i.e. all soils except LB), an increase in the number of bacterial and fungal gene copies was also found using LME analysis, indicating that the LC treatment also promoted bacterial and fungal growth (Fig. 2). Interestingly, although increases in bacterial and fungal gene copies were also observed with LC in these soils, there was an overall shift in the community structure, with phototroph gene copies increasing in relative abundance to the bacterial and fungal members (Fig. 2). Such a shift was also found in the LB soil, because of a decrease of bacterial and fungal gene copies induced by the LC treatment (Fig. 2).

The number of fungal gene copies was always relatively smaller than the phototroph and bacterial gene copies across all soil treatments (Fig. 2). In soils conditioned in the dark (DC treatment), the highest abundance of fungal gene copies was found in the most acidic soil, but the trend was opposite in soils conditioned to a day-night cycle (LC treatment). However, in terms of relative abundance their overall contribution within the community generally decreased with the LC treatment (Fig. 2).

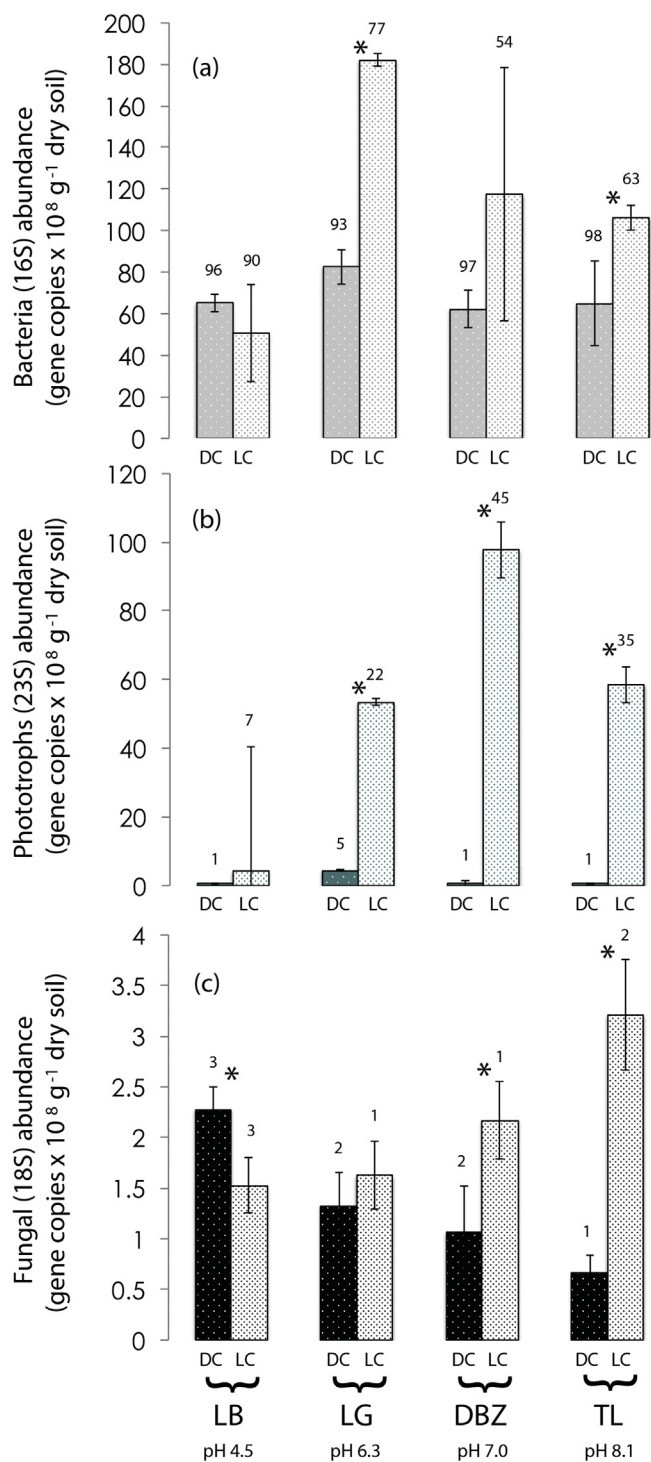

Fig. 2. Relative number of bacterial (16S), fungal (18S) and phototroph (23S) gene copies (\pm SD, $n = 3$) for the four soils (LB, LG, DBZ & TL) incubated in the dark (DC) and light (LC) after 40 days. Asterisks indicate soils incubation treatment (DC/LC) effect were significant ($p < 0.01$). Numbers above each bar plot indicate the relative abundance of the given microbial group in the given soil.

3.2. CO₂ flux

In all soils that had been conditioned to darkness (DC treatment) there was no significant change in net observed CO₂ fluxes with light availability (Fig. 3a, compare DC-DP and DC-LP). In addition, these dark-conditioned soils were always a source of CO₂ to the

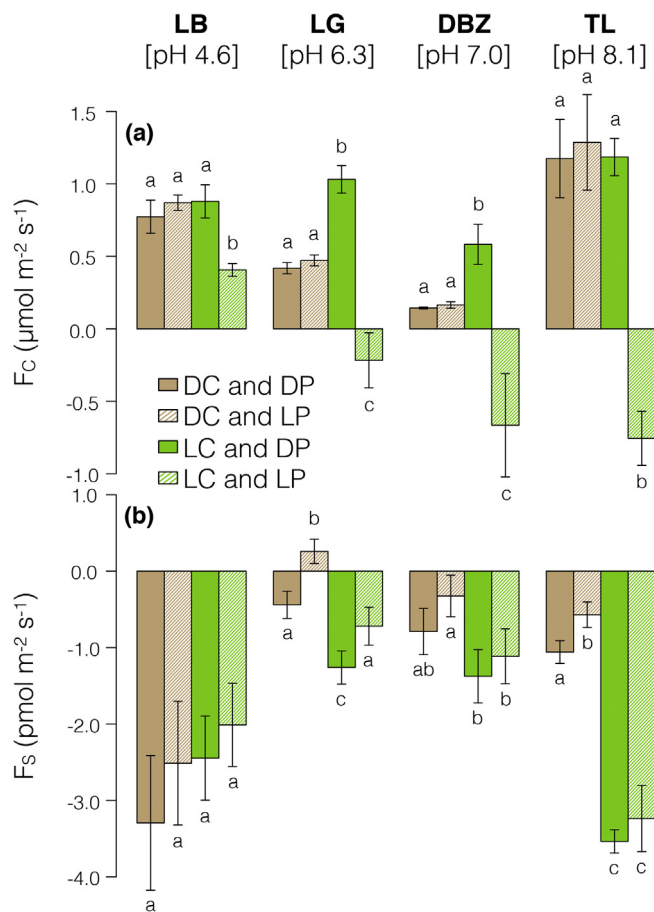

Fig. 3. Mean variations (\pm SD, $n = 3$) in the net soil (a) CO₂ and (b) OCS fluxes for four different soils measured in the light (LP) and the dark (DP) after incubation for 40 days in the light (LC) or the dark (DC). a, b and c indicate significant effects of both treatment within soils ($p < 0.05$).

atmosphere irrespective of whether they were measured in the light or in the dark. In contrast, the net CO₂ fluxes from soil microcosms conditioned to a day-night cycle (LC treatment) always differed significantly between the dark and light measurement periods, with reduced CO₂ emissions to the atmosphere or even CO₂ uptake in the light (Fig. 3a, compare LC-DP and LC-LP). The strength of this light response, characterised by the difference in the net CO₂ fluxes measured between light and dark periods ($\Delta F_{C, \text{light-dark}}$), partly reflected the changes in the abundance of 23S gene copies g⁻¹ of dry soil in the LC treatments (Fig. 2) but was best captured by differences in soil pH, with the largest light response occurring in the most alkaline soil (Fig. 4a).

Dark respiration rates from LC-incubated soils were generally the same or larger than DC-incubated soils (Fig. 3a, compare LC-DP and DC-DP). This difference was qualitatively reflected by the changes in the number of phototroph, fungal and bacterial gene copies caused by the conditioning treatment (Fig. 2), except in the most alkaline soil where the increase in gene copies did not translate into larger dark respiration rates.

3.3. OCS flux

Nearly all soil types and treatments were sinks for OCS (Fig. 3b). Only the dark conditioned soil from Lacage (LG) emitted OCS to the atmosphere when measured in the light. In both the DC- and LC-incubated soils there was an overall trend for the net OCS flux to

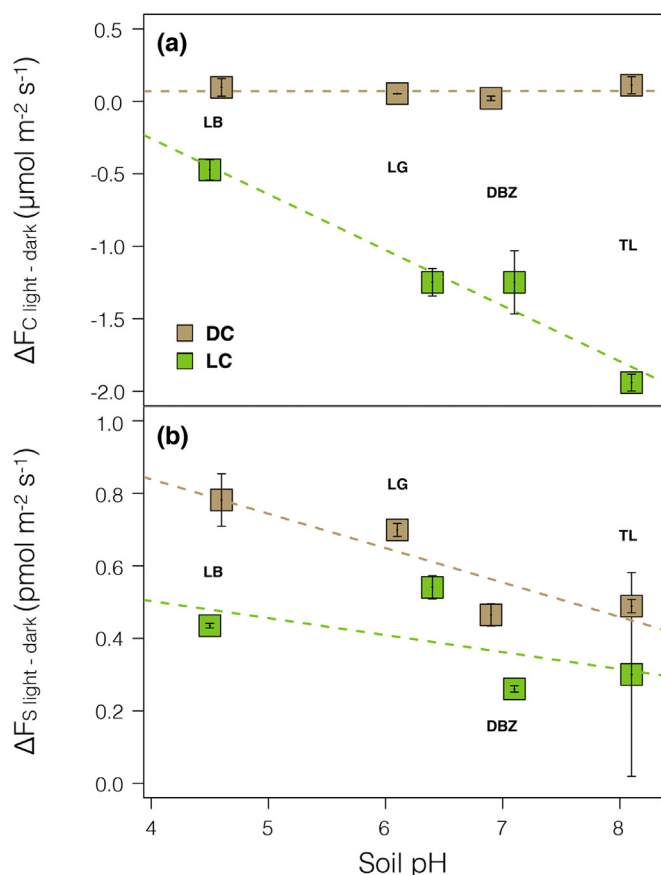

Fig. 4. Mean differences (\pm SD, $n = 3$) in the net soil (a) CO_2 and (b) OCS fluxes measured during the light (LP) and the dark (DP) period for four soils of different pH incubated in the light (LC) or the dark (DC) for ~40 days.

decrease when measured in light and thus become a weaker OCS sink (Fig. 3b). However, this difference in sink strength ($\Delta F_{S, \text{light-dark}}$) was not statistically significant from zero for the majority of soils (Fig. 4b).

Apart from the most acidic soil (LB), the effect of the incubation treatment was statistically significant, with light-conditioned soil microcosms acting as larger OCS sinks than dark-conditioned ones (Fig. 3b). This effect of the incubation treatment on the soil OCS fluxes seems to follow changes in the number of fungal gene copies between the two treatments (Fig. 2).

3.4. Relationship between fluxes and CA activity

To assess more quantitatively the link between soil microbial groups and gas exchange rates, we performed different tests on the DC- and LC-incubated datasets. We found that the net soil CO_2 flux was only correlated with the number of phototroph gene copies g^{-1} of dry soil and only during the light measurement periods (Fig. 5c). This correlation was negative and consistent with an increase in light-induced CO_2 uptake from the atmosphere as the number of phototroph gene copies increased. In contrast, we found that the net soil OCS flux was only correlated with the number of soil fungal 18S gene copies g^{-1} of dry soil with almost similar responses between light and dark measurements (Fig. 5e). Thus although the number of fungal gene copies was extremely low compared with either the bacterial or phototroph gene copies, even a small increase in the number of fungal gene copies within the community significantly increased the OCS sink strength.

Estimations of microcosm carbonic anhydrase activity were made using either the enzyme-catalysed rate of CO_2 - H_2O isotope exchange (k_{iso}) or the enzyme-catalysed OCS hydrolysis rate (k_{h}). Generally we found that k_{iso} varied between 0.01 and 0.75 s^{-1} , and was higher in the LC treatments compared to DC treatment (Fig. 6a), although not significantly on the acidic soil (LB) that exhibited very little difference in phototroph abundance (Fig. 5a). We also found that k_{iso} was positively correlated to the abundance of soil phototroph gene copies irrespective of the measurement period (LP or DP) (Fig. 6a). The shift in k_{iso} between DC and LC treatments on the different soils was however more directly related to differences in soil pH than algal and cyanobacterial DNA counts (Fig. 6b), with a clear monotonic increase of k_{iso} in LC treatments with more alkaline conditions. Estimated k_{h} varied between 0.002 and 0.028 s^{-1} and was positively correlated to fungal abundance across all soil treatments, but not other variables such as phototroph or bacterial counts or soil pH. As a consequence, and contrary to what we expected, no significant relationship was found between k_{iso} and k_{h} in this dataset.

4. Discussion

4.1. Light and pH as drivers of soil community structure

Major progress has been made describing how bacterial and fungal abundance and diversity varies with pH, land management and climate (Dequiedt et al., 2011; Griffiths et al., 2011; Lauber et al., 2008; Leff et al., 2015; Tedersoo et al., 2014) using a suite of novel molecular techniques (Bardgett & Van Der Putten, 2014). In contrast, these advances have not been widely implemented to characterise variations in soil phototroph communities, and as far as we are aware, no study using molecular tools has been used to explore the interactions of both the bacterial (16S) and eukaryotic algal (23S) phototroph communities alongside heterotrophic microbial groups in soils. Most studies to date, especially those focussing on dryland ecosystems and biocrusts, have tended to focus efforts on characterising the diversity and abundance of bacterial members of the biocrusts, notably the contribution of cyanobacteria (Couradeau et al., 2016; Steven et al., 2012, 2013, 2015a) and fungal communities (Bates et al., 2010; Steven et al., 2014, 2015b; Xiao and Veste, 2017) using 16S and 18S qPCR approaches. In addition, a combination of 16S and 18S genes have previously been used with other tools such as microscopy to assess algal diversity in high elevation and high-latitude drylands (Schmidt et al., 2011). However, most other studies on the ecology of soil algae and bacteria have used manual and time-consuming approaches such as soil slurry dilutions combined with identification and count techniques (Lund, 1947; Shields and Durrell, 1964; Stokes, 1940; Zancan et al., 2006). Nonetheless, from these early studies it was shown that the number of soil algae varies strongly with soil pH (Lukešová and Hoffmann, 1996; Lund, 1947; Metting, 1981; Shields and Durrell, 1964; Starks and Shubert, 1982; Stokes, 1940) and that the presence of soil algae could even change soil pH (Budel et al., 2004). These findings are consistent with the results of our study using a novel 23S approach on soils showing that phototroph abundance increased positively on alkaline soils when incubated in the light and at optimum water content.

Previous studies have also shown that the growth of soil algal populations is often accompanied by increases in bacterial populations (Ramanan et al., 2016; Stokes, 1940). In the case of our study if we infer that changes in the number of 16S and 23S gene copies represent a proxy for putative changes in the size of the respective communities we can also infer a similar pattern. In our study this might be partially explained by an increase in the cyanobacterial community in response to light and pH. For example,

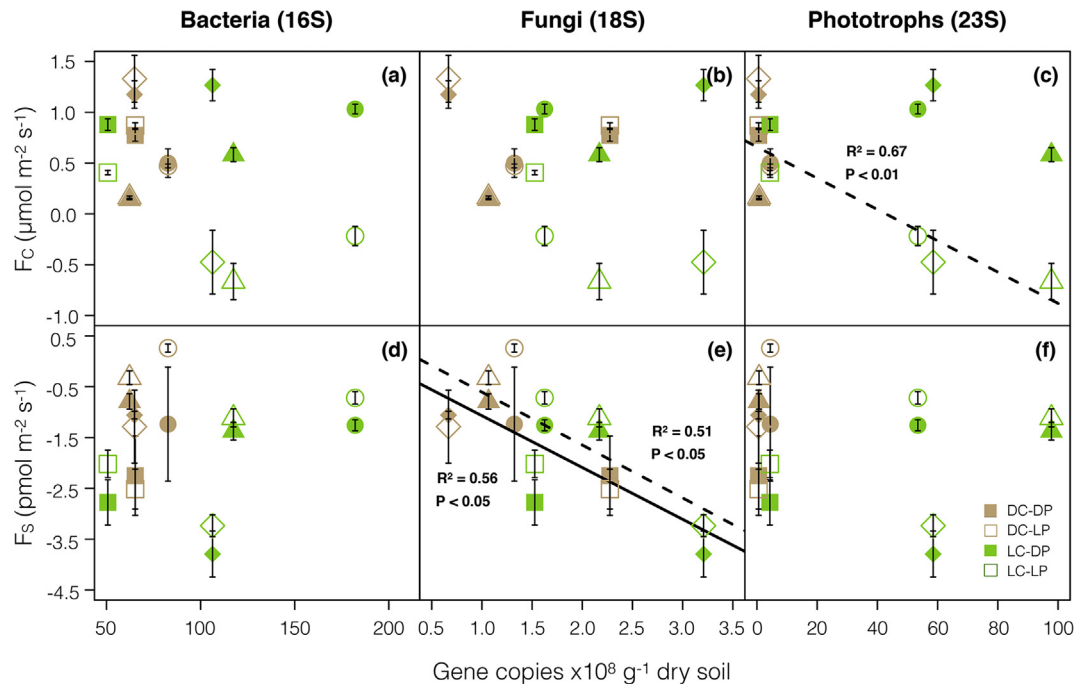

Fig. 5. Relationship between the net soil CO_2 and OCS fluxes for four soils (LB: squares, LG: circles, DBZ: triangles, TL: diamonds) as a function of the number of gene copies per gram of dry soil for bacteria (16S), fungi (18S) and phototrophs (23S) measured in the light (LP) and the dark (DP) after incubation for ~40 days in the light (LC) or the dark (DC). Significant linear model results are also displayed (solid lines for dark periods and dashed lines for light periods).

previous studies have shown that alkaline soils tend to promote the development of diatom and cyanobacterial species whilst acidic soils tend to favour green alga species from the chlorophyta (Metting, 1981; Shields and Durrell, 1964; Starks and Shubert, 1982). It has also been hypothesised that the development of algal communities may also be tracked by an increase in the number of nitrogen-fixing bacteria such as the *Azotobacter* (Stokes, 1940; Reay, 2015). These bacteria have evolved to grow rapidly in aerobic conditions and fix nitrogen from the atmosphere at optimal pH values of 7–7.5 (Garrity et al., 2005). It is also widely known that many soil microbes benefit from the soluble organic compounds secreted into the soil by phototrophs (Brock and Clyne, 1984; Cole et al., 1982; Larsson and Hagström, 1982). Indeed, the number of fungal gene copies was also positively related with the number of phototroph gene copies and pH but only in the light conditioned treatments. In contrast, microcosms incubated in the dark showed a decrease in fungal gene copies with increasing pH, demonstrating that a strong positive interaction between phototrophs and fungal communities exists. This is in some respects consistent with other studies that have found variations in fungal gene copies and diversity with pH (Tedersoo et al., 2014), and with other study findings that plant community composition (Leff et al., 2015) or soil C:N ratios (Lauber et al., 2008) may be better predictors of fungal community composition than pH. Our results indicate that the relationships between different members of the microbial groups and pH may be conditional on the presence of certain phototrophs. Investigating these differences in community member interactions were beyond the scope of our present study. However, on-going development of our molecular method should enable us to explore and better understand these finer scale relationships within the soil community groups in the near future.

4.2. The influence of soil community structure on CO_2 uptake

Most soils in the world emit CO_2 to the atmosphere (Bond-

Lamberty and Thomson, 2010; Raich and Schlesinger, 1992). However, there are a number of studies showing that some alkaline soils act as sinks for CO_2 (Elbert et al., 2012; Jasoni et al., 2005; Schlesinger et al., 2009; Wohlfahrt et al., 2008). This is typically explained by abiotic mechanisms such as thermally-induced pressure pumping or carbonate dissolution and CO_2 transport to groundwater (Schlesinger et al., 2009; Schlesinger, 2017). Recent studies have also shown that the process of carbonate formation is often microbially-induced and linked to CA activity (Benzerara et al., 2014; Couradeau et al., 2012; Kupriyanova et al., 2007; Li et al., 2005; Thaler et al., 2017), highlighting the potential of microbial communities in calcareous soils to enhance CO_2 uptake. Our study demonstrated that soil phototrophs have the potential to respond rapidly to seasonal changes in light. It also highlighted that the extent of the community response to light is strongly controlled by soil pH as discussed above. We showed that an increase in the putative abundance of native phototrophs has the potential to rapidly convert soils from being a net source to becoming a net sink of CO_2 during daylight hours. However, we also observed that soils containing more 23S gene copies generally respired more CO_2 than dark-conditioned soils during the dark period. Thus, on balance over a 24hr period with a 12 h/12 h day/night cycle, most soils (with the exception of DBZ at pH 7) remained a net source of CO_2 to the atmosphere.

Interestingly it is worth noting that variations in the putative abundance of soil phototrophs may introduce noise in diurnal and seasonal measurements of soil CO_2 respiration. For example, an important parameter in land surface models is the Q_{10} that describes how the sensitivity of the soil CO_2 efflux is driven by soil temperature (Lloyd and Taylor, 1994; Mahecha et al., 2010). There is a general tendency to have a higher Q_{10} in winter than in summer and macro-molecular rate theory has been evoked to help explain this pattern (Alster et al., 2016; Schipper et al., 2014). However, the presence of phototrophs could also lower estimates of Q_{10} by reducing the CO_2 efflux during the day when temperatures are high

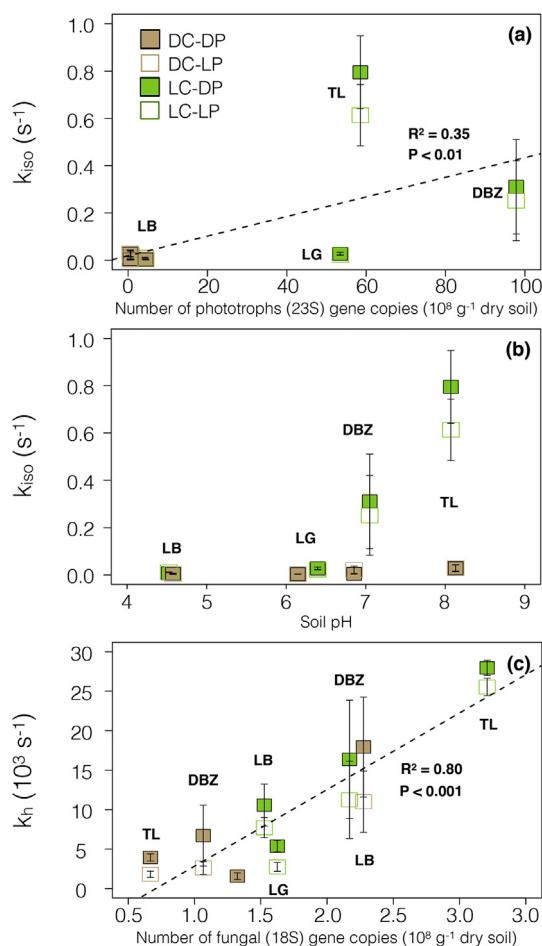

Fig. 6. Significant relationship found between CA-catalysed activity and (a) the number of phototroph gene copies per gram of dry soil using the oxygen isotopic exchange, (b) soil pH also using the oxygen isotopic exchange and (c) the number of fungal gene copies per gram of dry soil using the OCS hydrolysis rates for the four different soils measured in the light (open symbols; LP) and the dark (close symbols; DP) after ~40 days of incubation in the dark (brown symbols; DC) or the light (green symbols; LC). (For interpretation of the references to colour in this figure legend, the reader is referred to the web version of this article.)

and increasing it at night when temperatures are lower. Future studies exploring the link between phototroph abundance for different biomes and soil CO₂ efflux could help explain some of the emergent patterns observed in key C cycle model parameters and improve our ability to predict how they interplay with climate, soil and vegetation composition.

4.3. The influence of soil pH and community structure on CA activity

The enzyme carbonic anhydrase catalyses both the reversible hydration of CO₂ and the irreversible hydrolysis of OCS in algae (Gries et al., 1994; Protoschill-Krebs and Kesselmeier, 1992), bacteria (Kamezaki et al., 2016; Kesselmeier et al., 1999; Ogawa et al., 2013) and fungi (Elleuche and Poggeler, 2010; Masaki et al., 2016). The activity of this enzyme is essential for the homeostatic regulation of intra-cellular pH in organisms (Smith and Ferry, 2000). Most organisms strive to maintain a physiologically optimal pH of around 7 (Krulwich et al., 2011). However many organisms and indeed many bacterial and fungal genus have developed metabolic traits for surviving in extreme acidic and alkaline environments (Hesse et al., 2002; Krulwich et al., 2011; Mortensen

et al., 2008; Slonczewski et al., 2009), and the enzyme CA seems to play a central role in this survival. The results from our study confirmed that soil pH not only had a strong influence on the putative abundance of phototrophs but also on the strength of the photosynthetic CO₂ sink and associated CA activity (k_{180}). This result was unsurprising as it is well known that unicellular green algae, such as *Chlamydomonas*, typically exhibit CA activities as high as those found in animals or higher plants and can express different classes of CA in a range of organelles including the periplasmic membrane (Moroney et al., 2001; Palmqvist and Badger, 1996). It has also been shown for β -CA, the most abundant class of CA in soil bacteria and fungi, that the catalysed CO₂ hydration is maximal in the pH range above 8 (Rowlett et al., 2002).

More surprisingly our CA activity estimates for CO₂ and OCS did not co-vary between the different light treatments. The rate of enzyme-catalysed OCS hydrolysis (k_h) was surprisingly not significantly related to the putative abundance of phototrophs or soil pH but was only explained by changes in the number of fungal gene copies (Fig. 6c). This was even more surprising given that the relative number of fungal gene copies to the total number of gene copies g⁻¹ of soil was so small (Fig. 2), especially if we consider that the genomes of some fungal species can have several copies of the 18S operon (Fournier et al., 1986; Garber et al., 1988; Herrera et al., 2009; Howlett et al., 1997) potentially indicating that our 18S inferred estimates of putative fungal abundance could be over-estimated. Most fungi, including the Basidiomycetes and Hemi-ascmycetes, contain only β -CAs, although some filamentous Ascomycetes and 'basal fungi' such as the Chytridiomycota, and Blastocladiomycota, also contain genes for encoding α -CAs (Elleuche and Poggeler, 2010; Elleuche, 2011). In contrast, all three classes of CA seem rather common in bacteria (Smith et al., 1999) and algae (Moroney et al., 2001), although α -CA seem more abundant in algae whilst γ -CA are often found in bacteria. Thus a relative increase in fungal populations could be accompanied by a relative increase in β -CA expression. Little is currently known about the affinity of these different CA classes to OCS but a few studies seem to indicate that β -CAs have a much higher affinity to OCS than α -CA, leading to OCS hydrolysis rates up to 1000 times faster (Haritos & Dojchinov, 2005; Ogawa et al., 2013, 2016; Ogée et al., 2016). If γ -CAs have a similar affinity to OCS as α -CAs, then OCS uptake by soils should be mostly responsive to changes in β -CA expression. This may indicate that the relationship we found between k_h and the number of fungal gene copies is possibly dominated by the expression of β -CAs in fungi. This would be consistent with a recent study on forest soil fungal isolates that demonstrated that a number of species exhibited a strong uptake of OCS (Masaki et al., 2016). These species included *Scytalidium* sp. THIF03, *Trichoderma* spp. THIF08, THIF17, THIF21, THIF23 and THIF26 with *Trichoderma* species known to contain only β -CAs (Elleuche and Poggeler, 2010). Next generation sequencing (NGS) on our experimental soils will allow us to investigate whether changes in OCS flux can be associated to changes in the presence of these key fungal OCS degraders.

Alternatively, changes in OCS flux could have also been driven by a shift in the community structure towards fungal species that emit OCS, such as *Umbelopsis* and *Mortierella* spp. THIF09 and THIF13 (Masaki et al., 2016), especially in soils with a lower number of fungal gene copies. This particular hypothesis should definitely be tested in future studies using NGS. Nonetheless, with our current experimental approach it was clearly demonstrated, that when light and moisture were not limiting, phototrophs bloomed. This increase in phototroph gene copies also caused fungal gene copies, and to a lesser extent, bacterial gene copies to increase at the same time leading to a greater OCS uptake rate (and an exactly opposite response in the most acidic soil). Thus the presence of the

phototrophs conferred some benefit to the fungal population in non-acidic soils. This may have resulted either from the transfer (or leakage) of organic compounds to the fungi in a manner similar to the situation in lichens or by constituting prey to the fungi. For example many fungi in the *Chytridiomycota* are parasites of algae and are known to contain two β -CAs and one α -CA in secretions (Elleuche, 2011), that could putatively hydrolyse OCS. This hypothesis should also be tested in the future using NGS. This would help characterise the importance of OCS consuming and producing metabolic pathways in soil organisms and improve our ability to model the exchange of OCS from soils at larger scales.

5. Conclusion

Using molecular tools our study could reveal the interplay between soil pH and light in determining changes in the relative abundance of soil algal, bacterial and fungal gene copies. This additional information helped us interpret the fluxes of two key tracers in the global C cycle. Interestingly, our study showed for the first time that the magnitude of each of these fluxes was regulated differently. Soil pH and phototroph gene copies strongly drove the soil CO₂ efflux as well as the CO₂-H₂O isotopic exchange rate, emphasising the need to account for the variability of these environmental parameters to correctly use stable oxygen isotopes as a proxy of biospheric CO₂ fluxes. Our study also showed that changes in fungal gene copies exhibited a strong relationship with the rate of net OCS exchange. Finally our study demonstrates that, by combining such molecular tools with soil gas exchange measurements, it will soon be possible to assess the impact of both prokaryote and eukaryote phototroph activity and diversity on the ability to sequester C, N and S in soils and predict how soil community structure regulates CO₂ and OCS soil-atmosphere exchange.

Author contributions

JS, PAM, OC, JO and LW conceived and designed the experiment. JS, SW and SJ designed and conducted the gas-exchange and water isotope measurements. PAM, OC and VN designed and made the qPCR database and analysis. JS, JO, PAM, OC, AK and LW analysed the data. JS, LW, JO and OC wrote the manuscript. All authors commented and contributed to the final version.

Competing interest

The authors declare that they have no conflict of interest.

Acknowledgements

This project has received funding from the European Research Council (ERC) under the European Union's Seventh Framework Programme (FP7/2007–2013) (grant agreement No. 338264) awarded to L.W. and the Agence Nationale de la Recherche (ANR) award no. ANR-13-BS06-0005-01). JS was jointly funded by a PhD scholarship from the INRA departments EFPA and EA and the ANR project ORCA. We thank Noelia Saavedra, Juliette Maire and Noelia Fernandez for their assistance extracting soil waters. We also thank David Alletru and the INRA experimental unit of Toulence for their cooperation. We also thank Bernard Genty, Laura Meredith and Jurgen Kesselmeier for all their helpful discussions.

Appendix A. Supplementary data

Supplementary data related to this article can be found at <http://dx.doi.org/10.1016/j.soilbio.2017.09.009>.

References

- Alster, C.J., Baas, P., Wallenstein, M.D., Johnson, N.G., von Fischer, J.C., 2016. Temperature sensitivity as a microbial trait using parameters from macromolecular rate theory. *Frontiers in Microbiology* 7, 1821.
- Badger, M., 2003. The roles of carbonic anhydrases in photosynthetic CO₂ concentrating mechanisms. *Photosynthesis Research* 77, 83–94.
- Bardgett, R.D., Van Der Putten, W.H., 2014. Belowground biodiversity and ecosystem functioning. *Nature* 515, 505–511.
- Bates, S.T., Nash, T.H., Sweat, K.G., Garcia-Pichel, F., 2010. Fungal communities of lichen-dominated biological soil crusts: diversity, relative microbial biomass, and their relationship to disturbance and crust cover. *Journal of Arid Environments* 74, 1192–1199.
- Bates, S.T., Garcia-Pichel, F., 2009. A culture-independent study of free-living fungi in biological soil crusts of the Colorado Plateau: their diversity and relative contribution to microbial biomass. *Environmental Microbiology* 11, 56–67.
- Belnap, J., Lange, O.L. (Eds.), 2003. *Biological Soil Crusts: Structure, Function and Management*. Springer-Verlag, Berlin.
- Benzerara, K., Skouri-Panet, F., Li, J., Ferard, C., Gugger, M., Laurent, T., Couradeau, E., Ragon, M., Cosmidis, J., Menguy, N., Margaret-Oliver, I., Tavera, R., Lopez-Garcia, P., Moreira, D., 2014. Intracellular Ca-carbonate biomineralization is widespread in cyanobacteria. *Proceedings of the National Academy of Sciences* 111, 10933–10938.
- Bond-Lamberty, B., Thomson, A., 2010. A global database of soil respiration data. *Biogeosciences* 7, 1915–1926.
- Bowker, M.A., Maestre, F.T., Escobar, C., 2010. Biological crusts as a model system for examining the biodiversity–ecosystem function relationship in soils. *Soil Biology and Biochemistry* 42, 405–417.
- Bristol-Roach, M., 1927. On the algae of some normal English soils. *The Journal of Agricultural Science* 17, 563.
- Brock, T.D., Clyne, J., 1984. Significance of algal excretory products for growth of epilimnetic bacteria. *Applied and Environmental Microbiology* 47, 731–734.
- Budel, B., Weber, B., Kuhl, M., Pfanz, H., Sultemeyer, D., Wessels, D., 2004. Reshaping of sandstone surfaces by cryptoendolithic cyanobacteria: bioalkalization causes chemical weathering in arid landscapes. *Geobiology* 2, 261–268.
- Campbell, J.E., Carmichael, G.R., Chai, T., Mena-Carrasco, M., Tang, Y., Blake, D.R., Blake, N.J., Vay, S.A., Collatz, G.J., Baker, I., Berry, J.A., Montzka, S.A., Sweeney, C., Schnoor, J.L., Stanier, C.O., 2008. Photosynthetic control of atmospheric carbonyl sulfide during the growing season. *Science* 322, 1085–1088.
- Carvalhais, N., Forkel, M., Khomik, M., Bellarby, J., Jung, M., Migliavacca, M., Mu, M., Saatchi, S., Santoro, M., Thurner, M., Weber, U., Ahrens, B., Beer, C., Cescatti, A., Randerson, J.T., Reichstein, M., 2014. Global covariation of carbon turnover times with climate in terrestrial ecosystems. *Nature* 514, 213–217.
- Castillo-Monroy, A.P., Maestre, F.T., Rey, A., Soliveres, S., Garcia-Palacios, P., 2011. Biological soil crust microsites are the main contributor to soil respiration in a semiarid ecosystem. *Ecosystems* 14, 835–847.
- Chemidlin Prévost-Bouré, N., Christen, R., Dequiedt, S., Mougél, C., Lelièvre, M., Jolivet, C., Shahbazkia, H.R., Guillou, L., Arrouays, D., Ranjard, L., 2011. Validation and application of a PCR primer set to quantify fungal communities in the soil environment by real-time quantitative PCR. *PLoS One* 6, e24166.
- Cole, J.J., Likens, G.E., Strayer, D.L., 1982. Photosynthetically produced dissolved organic carbon: an important carbon source for planktonic bacteria. *Limnology and Oceanography* 27, 1080–1090.
- Coleman, J.R., Berry, J.A., Togasaki, R.K., Grossman, A.R., 1984. Identification of extracellular carbonic anhydrase of *Chlamydomonas reinhardtii*. *Plant Physiology* 76, 472–477.
- Couradeau, E., Benzerara, K., Gerard, E., Moreira, D., Bernard, S., Brown, G.E., Lopez-Garcia, P., 2012. An early-branching microbialite cyanobacterium forms intracellular carbonates. *Science* 336, 459–462.
- Couradeau, E., Karaoz, U., Lim, H.C., Nunes da Rocha, U., Northen, T., Brodie, E., Garcia-Pichel, F., 2016. Bacteria increase arid-land soil surface temperature through the production of sunscreens. *Nature Communications* 7, 10373.
- Cuntz, M., 2003. A comprehensive global three-dimensional model of $\delta^{18}\text{O}$ in atmospheric CO₂: 1. Validation of surface processes. *Journal of Geophysical Research* 108, 1–24.
- Dequiedt, S., Saby, N.P.A., Lelièvre, M., Jolivet, C., Thioulouse, J., Toutain, B., Arrouays, D., Bispo, A., Lemanceau, P., Ranjard, L., 2011. Biogeographical patterns of soil molecular microbial biomass as influenced by soil characteristics and management. *Global Ecology and Biogeography* 20, 641–652.
- Elbert, W., Weber, B., Burrows, S., Steinkamp, J., Büdel, B., Andreae, M.O., Pöschl, U., 2012. Contribution of cryptogamic covers to the global cycles of carbon and nitrogen. *Nature Geoscience* 5, 459–462.
- Elleuche, S., 2011. Carbonic anhydrase in fungi and fungal-like organisms - functional distribution and evolution of a gene family. *Mycota* 14, 257–274.
- Elleuche, S., Poggeler, S., 2010. Carbonic anhydrases in fungi. *Microbiology* 156, 23–29.
- Evans, R., Johansen, J., 1999. Microbiotic crusts and ecosystem processes. *Critical Reviews in Plant Sciences* 18, 183–225.
- Fierer, N., Jackson, R.B., 2006. The diversity and biogeography of soil bacterial communities. *Proceedings of the National Academy of Sciences* 103, 626–631.
- Flemming, H.C., Wingender, J., Szewzyk, U., Steinberg, P., Rice, S.A., Kjelleberg, S., 2016. Biofilms: an emergent form of bacterial life. *Nature Reviews Microbiology* 14, 563–575.
- Fournier, P., Gaillardin, C., Persuy, M.-A., Klootwijk, J., Heerikhuizen, H. van, 1986.

- Heterogeneity in the ribosomal family of the yeast *Yarrowia lipolytica*: genomic organization and segregation studies. *Gene* 42, 273–282.
- Francey, R.J., Tans, P.P., 1987. Latitudinal variation in oxygen-18 of atmospheric CO₂. *Nature* 327, 495–497.
- Garber, R.C., Turgeon, G.B., Selker, E.U., Yoder, O.C., 1988. Organization of ribosomal RNA genes in the fungus *Cochliobolus heterostrophus*. *Current Genetics* 14, 573–582.
- Garrity, G.M., Brenner, D.J., Krieg, N.R., Staley, J.R., 2005. Taxonomic Outline of the Prokaryotes. *Bergey's Manual of Systematic Bacteriology*. Springer, New York, Berlin, Heidelberg.
- Gimeno, T.E., Ogée, J., Royles, J., Gibon, Y., West, J.B., Burrell, R., Jones, S.P., Sauze, J., Wohl, S., Benard, C., Genty, B., Wingate, L., 2017. Bryophyte gas-exchange dynamics along varying hydration status reveal a significant carbonyl sulphide (COS) sink in the dark and COS source in the light. *New Phytologist* 215, 965–976.
- Goyal, S., 1997. Algae and the soil environment. *Phykos* 36, 1–13.
- Gries, C., Nash, T.H., Kesselmeier, J., 1994. Exchange of reduced sulfur gases between lichens and the atmosphere. *Biogeochemistry* 26, 25–39.
- Griffiths, R.L., Thomson, B.C., James, P., Bell, T., Bailey, M., Whiteley, A.S., 2011. The bacterial biogeography of British soils. *Environmental Microbiology* 13, 1642–1654.
- Haney, R.L., Haney, E.B., 2010. Simple and rapid laboratory method for rewetting dry soil for incubations. *Communications in Soil Science and Plant Analysis* 41, 1493–1501.
- Haritos, V.S., Dojchinov, G., 2005. Carbonic anhydrase metabolism is a key factor in the toxicity of CO₂ and COS but not CS₂ toward the flour beetle *Tribolium castaneum* [Coleoptera: tenebrionidae]. *Comparative Biochemistry and Physiology C: Toxicology & Pharmacology* 140, 139–147.
- Hart, K.M., Kulakova, A.N., Allen, C.C.R., Simpson, A.J., Oppenheimer, S.F., Masoom, H., Courtier-Murias, D., Soong, R., Kulakov, L.A., Flanagan, P.V., Murphy, B.T., Kelleher, B.P., 2013. Tracking the fate of microbially sequestered carbon dioxide in soil organic matter. *Environmental Science & Technology* 47, 5128–5137.
- Heimann, M., Reichstein, M., 2008. Terrestrial ecosystem carbon dynamics and climate feedbacks. *Nature* 451, 289–292.
- Herrera, M.L., Vallor, A.C., Gelfond, J.A., Patterson, T.F., Wickes, B.L., 2009. Strain-dependent variation in 18S ribosomal DNA copy numbers in *Aspergillus fumigatus*. *Journal of Clinical Microbiology* 47, 1325–1332.
- Hesse, S.J.A., Ruijter, G.J.G., Dijkema, C., Visser, J., 2002. Intracellular pH homeostasis in the filamentous fungus *Aspergillus Niger*. *European Journal of Biochemistry* 269, 3485–3494.
- Hopkinson, B.M., Meile, C., Shen, C., 2013. Quantification of extracellular carbonic anhydrase activity in two marine diatoms and investigation of its role. *Plant Physiology* 162, 1142–1152.
- Howlett, B.J., Rolls, B.D., Cozijnsen, A.J., 1997. Organisation of ribosomal DNA in the ascomycete *Leptosphaeria maculans*. *Microbiological Research* 152, 261–267.
- IUSS Working Group WRB, 2006. World Reference Base for Soil Re- Sources 2006. World Soil Resources Report 103, second ed. FAO, Rome.
- Jasoni, R.L., Smith, S.D., Arnone, J.A., 2005. Net ecosystem CO₂ exchange in Mojave Desert shrublands during the eighth year of exposure to elevated CO₂. *Global Change Biology* 11, 749–756.
- John, R.P., 1942. An ecological and taxonomic study of the algae of british soils. *Annals of Botany* 6, 323–349.
- Kamezaki, K., Hattori, S., Ogawa, T., Toyoda, S., Kato, H., Katayama, Y., Yoshida, N., 2016. Sulfur isotopic fractionation of carbonyl sulfide during degradation by soil bacteria. *Environmental Science & Technology* 50, 3537–3544.
- Kesselmeier, J., Teusch, N., Kuhn, U., 1999. Controlling variables for the uptake of atmospheric carbonyl sulfide by soil. *Journal of Geophysical Research: Atmospheres* 104, 11577–11584.
- Konopka, A., Lindemann, S., Fredrickson, J., 2015. Dynamics in microbial communities: unraveling mechanisms to identify principles. *The ISME Journal* 9, 1488–1495.
- Krulwich, T.A., Sachs, G., Padan, E., 2011. Molecular aspects of bacterial pH sensing and homeostasis. *Nature Reviews Microbiology* 9, 330–343.
- Kupriyanova, E., Villarejo, A., Markelova, A., Gerasimenko, L., Zavarzin, G., Samuelsson, G., Los, D.A., Pronina, N., 2007. Extracellular carbonic anhydrases of the stromatolite-forming cyanobacterium *Microcoleus chthonoplastes*. *Microbiology* 153, 1149–1156.
- Lan, S., Wu, L., Zhang, D., Hu, C., 2015. Analysis of environmental factors determining development and succession in biological soil crusts. *Science of The Total Environment* 538, 492–499.
- Larsson, U., Hagström, A., 1982. Fractionated phytoplankton primary production, exudate release and bacterial production in a Baltic eutrophication gradient. *Marine Biology* 67, 57–70.
- Lauber, C.L., Hamady, M., Knight, R., Fierer, N., 2009. Pyrosequencing-Based assessment of soil pH as a predictor of soil bacterial community structure at the continental scale. *Applied and Environmental Microbiology* 75, 5111–5120.
- Lauber, C.L., Strickland, M.S., Bradford, M.A., Fierer, N., 2008. The influence of soil properties on the structure of bacterial and fungal communities across land-use types. *Soil Biology and Biochemistry* 40, 2407–2415.
- Lee, C.K., Barbier, B.A., Bottos, E.M., McDonald, I.R., Cary, S.C., 2012. The inter-valley soil comparative survey: the ecology of dry valley edaphic microbial communities. *The ISME Journal* 6, 1046–1057.
- Leff, J.W., Jones, S.E., Prober, S.M., Barberán, A., Borer, E.T., Firn, J.L., Harpole, W.S., Hobbie, S.E., Hofmöckel, K.S., Knops, J.M.H., McCulley, R.L., La Pierre, K., Risch, A.C., Seabloom, E.W., Schütz, M., Steenbock, C., Stevens, C.J., Fierer, N., 2015. Consistent responses of soil microbial communities to elevated nutrient inputs in grasslands across the globe. *Proceedings of the National Academy of Sciences* 112, 10967–10972.
- Li, W., Yu, L., Yuan, D., Wu, Y., Zeng, X., 2005. A study of the activity and ecological significance of carbonic anhydrase from soil and its microbes from different karst ecosystems of Southwest China. *Plant and Soil* 272, 133–141.
- Lloyd, J., Taylor, J.A., 1994. On the temperature dependence of soil respiration. *Functional Ecology* 8, 315.
- Lukešová, A., Hoffmann, L., 1996. Soil algae from acid rain impacted forest areas of the Krušné hory Mts. 1. Algal communities. *Vegetatio* 125, 123–136.
- Lund, J.W.G., 1947. Observations on soil algae II. Notes on groups other than diatoms. *New Phytologist* 46, 35–60.
- Maestre, F.T., Bowker, M.A., Escobar, C., Puche, M.D., Soliveres, S., Maltez-Mouro, S., Garcia-Palacios, P., Castillo-Monroy, A.P., Martinez, I., Escudero, A., 2010. Do biotic interactions modulate ecosystem functioning along stress gradients? Insights from semi-arid plant and biological soil crust communities. *Philosophical Transactions of the Royal Society B: Biological Sciences* 365, 2057–2070.
- Mahecha, M.D., Reichstein, M., Carvalhais, N., Lasslop, G., Lange, H., Seneviratna, S.I., Vargas, R., Ammann, C., Arain, M.A., Cescatti, A., Janssens, I.A., Migliavacca, M., Montagnani, L., Richardson, A.D., 2010. Global convergence in the temperature sensitivity of respiration at ecosystem level. *Science* 329, 838–840.
- Masaki, Y., Ozawa, R., Kageyama, K., Katayama, Y., 2016. Degradation and emission of carbonyl sulfide, an atmospheric trace gas, by fungi isolated from forest soil. *FEMS Microbiology Letters* 363, 1–7.
- Metting, B., 1981. The systematics and ecology of soil algae. *The Botanical Review* 47, 195–312.
- Moldrup, P., Olesen, T., Komatsu, T., Yoshikawa, S., Schjønning, P., Rolston, D.E., 2003. Modeling Diffusion and reaction in soils: X. A unifying model for solute and gas diffusivity in unsaturated soil. *Soil Science* 168, 321–337.
- Montzka, S.A., Aydin, M., Battle, M., Butler, J.H., Saltzman, E.S., Hall, B.D., Clarke, A.D., Mondeel, D., Elkins, J.W., 2004. A 350-year atmospheric history for carbonyl sulfide inferred from Antarctic firn air and air trapped in ice. *Journal of Geophysical Research: Atmospheres* 109, D22302.
- Moroney, J.V., Bartlett, S.G., Samuelsson, G., 2001. Carbonic anhydrases in plants and algae. *Plant, Cell and Environment* 24, 141–153.
- Mortensen, H.D., Jacobsen, T., Koch, A.G., Arneborg, N., 2008. Intracellular pH homeostasis plays a role in the tolerance of *Debaryomyces hansenii* and *Candida zeylanoides* to acidified nitrite. *Applied and Environmental Microbiology* 74, 4835–4840.
- Nagy, M.L., Pérez, A., Garcia-Pichel, F., 2005. The prokaryotic diversity of biological soil crusts in the sonoran desert (organ pipe cactus national monument, AZ). *FEMS Microbiology Ecology* 54, 233–245.
- Notni, J., Schenk, S., Protoschill-Krebs, G., Kesselmeier, J., Anders, E., 2007. The missing link in COS metabolism: a model study on the reactivation of carbonic anhydrase from its hydrosulfide analogue. *ChemBioChem* 8, 530–536.
- Nowak, M.E., Beulig, F., von Fischer, J., Muhr, J., Küsel, K., Trumbore, S.E., 2015. Autotrophic fixation of geogenic CO₂ by microorganisms contributes to soil organic matter formation and alters isotope signatures in a wetland mofette. *Biogeochemistry* 12, 7169–7183.
- Ogawa, T., Kato, H., Higashide, M., Nishimiya, M., Katayama, Y., 2016. Degradation of carbonyl sulfide by Actinomycetes and detection of clade D of β-class carbonic anhydrase. *FEMS Microbiology Letters* 363, 1–9.
- Ogawa, T., Noguchi, K., Saito, M., Nagahata, Y., Kato, H., Ohtaki, A., Nakayama, H., Dohmae, N., Matsushita, Y., Odaka, M., Yohda, M., Nyunoya, H., Katayama, Y., 2013. Carbonyl sulfide hydrolase from *thiobacillus thioparus* strain TH115 is one of the β-carbonic anhydrase family enzymes. *Journal of the American Chemical Society* 135, 3818–3825.
- Ogée, J., Sauze, J., Kesselmeier, J., Genty, B., Van Diest, H., Launois, T., Wingate, L., 2016. A new mechanistic framework to predict OCS fluxes from soils. *Biogeochemistry* 13, 2221–2240.
- Palmqvist, K., Badger, M.R., 1996. Carbonic anhydrase(s) associated with lichens: in vivo activities, possible locations and putative roles. *New Phytologist* 132, 627–639.
- Pinheiro, J., Bates, D., Debroy, S., Sarkar, D., 2015. R Core Team. *nlme: Linear and Nonlinear Mixed Effects Models*, R Package Version 3, pp. 1–120.
- Plassart, P., Terrat, S., Thomson, B., Griffiths, R., Dequiedt, S., Lelievre, M., Regnier, T., Nowak, V., Bailey, M., Lemanceau, P., Bispo, A., Chabbi, A., Maron, P.-A., Mougé, C., Ranjard, L., 2012. Evaluation of the ISO standard 11063 DNA extraction procedure for assessing soil microbial abundance and community structure. *PLoS One* 7, e44279.
- Protoschill-Krebs, G., Wilhelm, C., Kesselmeier, J., 1996. Consumption of carbonyl sulphide (COS) by higher plant carbonic anhydrase (CA). *Atmospheric Environment* 30, 3151–3156.
- Protoschill-Krebs, G., Kesselmeier, J., 1992. Enzymatic pathways for the consumption of carbonyl sulphide (COS) by higher plants. *Botanica Acta* 105, 206–212.
- R Core Team, 2015. *R: A Language and Environment for Statistical Computing*. R Foundation for Statistical Computing, Vienna, Austria [online] Available from: <https://www.R-project.org>.
- Raich, J.W., Schlesinger, W.H., 1992. The global carbon dioxide flux in soil respiration and its relationship to vegetation and climate. *Tellus B* 44, 81–99.
- Ramanan, R., Kim, B.H., Cho, D.H., Oh, H.M., Kim, H.S., 2016. Algae–bacteria interactions: evolution, ecology and emerging applications. *Biotechnology Advances* 34, 14–29.

- Rousk, J., Bååth, E., Brookes, P.C., Lauber, C.L., Lozupone, C., Caporaso, J.G., Knight, R., Fierer, N., 2010. Soil bacterial and fungal communities across a pH gradient in an arable soil. *The ISME Journal* 4, 1340–1351.
- Reay, D., 2015. Marine nitrogen and climate change. In: *Nitrogen and Climate Change*. Palgrave Macmillan, UK, pp. 125–143.
- Rowlett, R.S., Tu, C., McKay, M.M., Preiss, J.R., Loomis, R.J., Hicks, K.A., Marchione, R.J., Strong, J.A., Donovan, G.S., Chamberlin, J.E., 2002. Kinetic characterization of wild-type and proton transfer-impaired variants of β -carbonic anhydrase from *Arabidopsis thaliana*. *Archives of Biochemistry and Biophysics* 404, 197–209.
- Sandoval-Soto, L., Stanimirov, M., von Hobe, M., Schmitt, V., Valdes, J., Wild, A., Kesselmeier, J., 2005. Global uptake of carbonyl sulfide (COS) by terrestrial vegetation: estimates corrected by deposition velocities normalized to the uptake of carbon dioxide (CO₂). *Biogeosciences* 2, 125–132.
- Šantrůčková, H., Bird, M.I., Elhottová, D., Novák, J., Píček, T., Šimek, M., Tykva, R., 2005. Heterotrophic fixation of CO₂ in soil. *Microbial Ecology* 49, 218–225.
- Schipper, L.A., Hobbs, J.K., Rutledge, S., Arcus, V.L., 2014. Thermodynamic theory explains the temperature optima of soil microbial processes and high Q₁₀ values at low temperatures. *Global Change Biology* 20, 3578–3586.
- Schlesinger, W.H., 2017. An evaluation of abiotic carbon sinks in deserts. *Global Change Biology* 23, 25–27.
- Schlesinger, W.H., Belnap, J., Marion, G., 2009. On carbon sequestration in desert ecosystems. *Global Change Biology* 15, 1488–1490.
- Schmidt, S.K., Lynch, R.C., King, A.J., Karki, D., Robeson, M.S., Nagy, L., Williams, M.W., Mitter, M.S., Freeman, K.R., 2011. Phylogeography of microbial phototrophs in the dry valleys of the high Himalayas and Antarctica. *Proceedings of the Royal Society B: Biological Sciences* 278, 702–708.
- Sherwood, A.R., Presting, G.G., 2007. Universal primers amplify a 23S rDNA plastid marker in eukaryotic algae and cyanobacteria. *Journal of Phycology* 43, 605–608.
- Shields, L.M., Durrell, L.W., 1964. Algae in relation to soil fertility. *The Botanical Review* 30, 92–128.
- Slonczewski, J.L., Fujisawa, M., Dopson, M., Krulwich, T.A., 2009. Cytoplasmic pH measurement and homeostasis in bacteria and archaea. In: *Advances in Microbial Physiology*. Elsevier, pp. 1–79.
- Smith, K.S., Ferry, J.G., 2000. Prokaryotic carbonic anhydrases. *FEMS Microbiology Reviews* 24, 335–366.
- Smith, K.S., Jakubzick, C., Whittam, T.S., Ferry, J.G., 1999. Carbonic anhydrase is an ancient enzyme widespread in prokaryotes. *Proceedings of the National Academy of Sciences* 96, 15184–15189.
- Starks, T.L., Shubert, L.E., 1982. Colonization and succession of algae and soil-algal interactions associated with disturbed areas. *Journal of Phycology* 18, 99–107.
- Steven, B., Kuske, C.R., Gallegos-Graves, L.V., Reed, S.C., Belnap, J., 2015a. Climate change and physical disturbance manipulations result in distinct biological soil crust communities. *Applied and Environmental Microbiology* 81, 7448–7459.
- Steven, B., Gallegos-Graves, L.V., Yeager, C., Belnap, J., Kuske, C.R., 2014. Common and distinguishing features of the bacterial and fungal communities in biological soil crusts and shrub root zone soils. *Soil Biology and Biochemistry* 69, 302–312.
- Steven, B., Gallegos-Graves, L.V., Belnap, J., Kuske, C.R., 2013. Dryland soil microbial communities display spatial biogeographic patterns associated with soil depth and soil parent material. *FEMS Microbiology Ecology* 86, 101–113.
- Steven, B., Gallegos-Graves, L.V., Starkenburg, S.R., Chain, P.S., Kuske, C.R., 2012. Targeted and shotgun metagenomic approaches provide different descriptions of dryland soil microbial communities in a manipulated field study. *Environmental Microbiology Reports* 4, 248–256.
- Steven, B., Hesse, C., Gallegos-Graves, L.V., Belnap, J., Kuske, C.R., 2015b. Fungal diversity in biological soil crusts of the Colorado plateau. In: *Proc 12th Biennial Conf Science Management Colorado Plateau*.
- Stokes, J.L., 1940. The influence of environmental factors upon the development of algae and other microorganisms in soil. *Soil Science* 49, 171–184.
- Sültemeyer, D., 1998. Carbonic anhydrase in eukaryotic algae: characterization, regulation, and possible function during photosynthesis. *Canadian Journal of Botany* 76, 962–972.
- Tans, P., 1998. Oxygen isotopic equilibrium between carbon dioxide and water in soils. *Tellus B* 50, 163–178.
- Tedersoo, L., Bahram, M., Polme, S., Koljalg, U., Yorou, N.S., Wijesundera, R., Ruiz, L.V., Vasco-Palacios, A.M., Thu, P.Q., Suija, A., Smith, M.E., Sharp, C., Saluveer, E., Saitta, A., Rosas, M., Riit, T., Ratkowsky, D., Pritsch, K., Poldmaa, K., Piepenbring, M., Phosri, C., Peterson, M., Parts, K., Partel, K., Otsing, E., Nouhra, E., Njouonkou, A.L., Nilsson, R.H., Morgado, L.N., Mayor, J., May, T.W., Majuakim, L., Lodge, D.J., Lee, S.S., Larsson, K.-H., Kohout, P., Hosaka, K., Hiiesalu, I., Henkel, T.W., Harend, H., Guo, L.-d., Greslebin, A., Grelet, G., Geml, J., Gates, G., Dunstan, W., Dunk, C., Drenkhan, R., Dearnaley, J., De Kesel, A., Dang, T., Chen, X., Buegger, F., Brearley, F.Q., Bonito, G., Anslan, S., Abell, S., Abarenkov, K., 2014. Global diversity and geography of soil fungi. *Science* 346, 1256688–1256688.
- Terrat, S., Christen, R., Dequiedt, S., Lelièvre, M., Nowak, V., Regnier, T., Bachar, D., Plassart, P., Wincker, P., Jolivet, C., Bispo, A., Lemanceau, P., Maron, P.-A., Mougel, C., Ranjard, L., 2012. Molecular biomass and MetaTaxogenomic assessment of soil microbial communities as influenced by soil DNA extraction procedure. *Microbial Biotechnology* 5, 135–141.
- Thaler, C., Millo, C., Ader, M., Chaduteau, C., Guyot, F., Ménez, B., 2017. Disequilibrium $\delta^{18}\text{O}$ values in microbial carbonates as a tracer of metabolic production of dissolved inorganic carbon. *Geochimica et Cosmochimica Acta* 199, 112–129.
- Thompson, J.R., Rivera, H.E., Closek, C.J., Medina, M., 2015. Microbes in the coral holobiont: partners through evolution, development, and ecological interactions. *Frontiers in Cellular and Infection Microbiology* 4, 176.
- Welp, L.R., Keeling, R.F., Meijer, H. a J., Bollenbacher, A.F., Piper, S.C., Yoshimura, K., Francey, R.J., Allison, C.E., Wahlen, M., 2011. Interannual variability in the oxygen isotopes of atmospheric CO₂ driven by El Niño. *Nature* 477, 579–582.
- Wingate, L., Ogee, J., Burlett, R., Bosc, A., 2010. Strong seasonal disequilibrium measured between the oxygen isotope signals of leaf and soil CO₂ exchange. *Global Change Biology* 16, 3048–3064.
- Wingate, L., Ogee, J., Cuntz, M., Genty, B., Reiter, I., Seibt, U., Yakir, D., Maseyk, K., Pendall, E.G., Barbour, M.M., Mortazavi, B., Burlett, R., Peylin, P., Miller, J., Mencuccini, M., Shim, J.H., Hunt, J., Grace, J., 2009. The impact of soil microorganisms on the global budget of ¹⁸O in atmospheric CO₂. *Proceedings of the National Academy of Sciences* 106, 22411–22415.
- Wingate, L., Seibt, U., Maseyk, K., Ogee, J., Almeida, P., Yakir, D., Pereira, J.S., Mencuccini, M., 2008. Evaporation and carbonic anhydrase activity recorded in oxygen isotope signatures of net CO₂ fluxes from a Mediterranean soil. *Global Change Biology* 14, 2178–2193.
- Wohlfaht, G., Fenstermaker, L.F., Arnone, J.A., 2008. Large annual net ecosystem CO₂ uptake of a Mojave Desert ecosystem. *Global Change Biology* 14, 1475–1487.
- Xiao, B., Veste, M., 2017. Moss-dominated biocrusts increase soil microbial abundance and community diversity and improve soil fertility in semi-arid climates on the Loess Plateau of China. *Applied Soil Ecology* 117–118, 165–177.
- Yuan, H., Ge, T., Wu, X., Liu, S., Tong, C., Qin, H., Wu, M., Wei, W., Wu, J., 2012. Long-term field fertilization alters the diversity of autotrophic bacteria based on the ribulose-1,5-bisphosphate carboxylase/oxygenase (RubisCO) large-subunit genes in paddy soil. *Applied Microbiology and Biotechnology* 95, 1061–1071.
- Zancan, S., Trevisan, R., Paoletti, M.G., 2006. Soil algae composition under different agro-ecosystems in North-Eastern Italy. *Agriculture, Ecosystems & Environment* 112, 1–12.