



HAL
open science

Stress distribution inside a powder bed: does Janssen's model applicable locally in a granular medium

Agnès Duri-Bechemilh, Sandra Mandato, Bernard Cuq, Thierry Ruiz

► To cite this version:

Agnès Duri-Bechemilh, Sandra Mandato, Bernard Cuq, Thierry Ruiz. Stress distribution inside a powder bed: does Janssen's model applicable locally in a granular medium. 7. World Congress on Particle Technology (WCPT7), May 2014, Pekin, China. hal-01606814

HAL Id: hal-01606814

<https://hal.science/hal-01606814>

Submitted on 3 Jun 2020

HAL is a multi-disciplinary open access archive for the deposit and dissemination of scientific research documents, whether they are published or not. The documents may come from teaching and research institutions in France or abroad, or from public or private research centers.

L'archive ouverte pluridisciplinaire **HAL**, est destinée au dépôt et à la diffusion de documents scientifiques de niveau recherche, publiés ou non, émanant des établissements d'enseignement et de recherche français ou étrangers, des laboratoires publics ou privés.



Distributed under a Creative Commons Attribution - ShareAlike 4.0 International License

WCPT 7

T1.2 Particle property and inter-particle force characterization

**Stress distribution inside a powder bed:
does Janssen's model applicable locally
in a granular medium?**

Sandra Mandato, **Agnès Duri***, Bernard Cuq and Thierry Ruiz

UMR IATE

<http://umr-iate.cirad.fr/>

2 Place Pierre Viala - 34000 Montpellier – FRANCE



* duri@supagro.inra.fr

**What is the local stress distribution
in an ensiled granular media ?**



What is the local stress distribution in an ensiled granular media ?



Applications:

- ” Stability of silos
- ” Initial state before powder flowing (mixing processing...)

The well-known Janssen's experiment (1895)

Weight measurement at the **bottom** of a cylindrical grain column

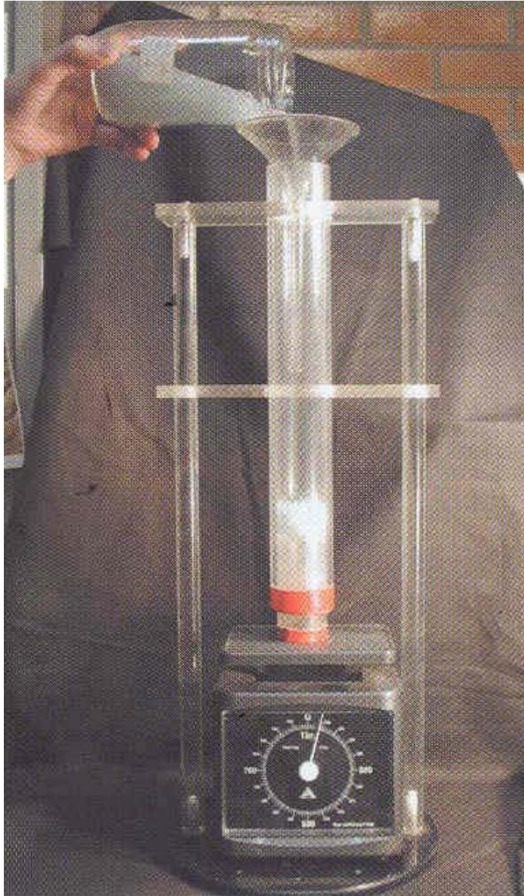

The well-known Janssen's experiment (1895)

Weight measurement at the bottom of a cylindrical grain column

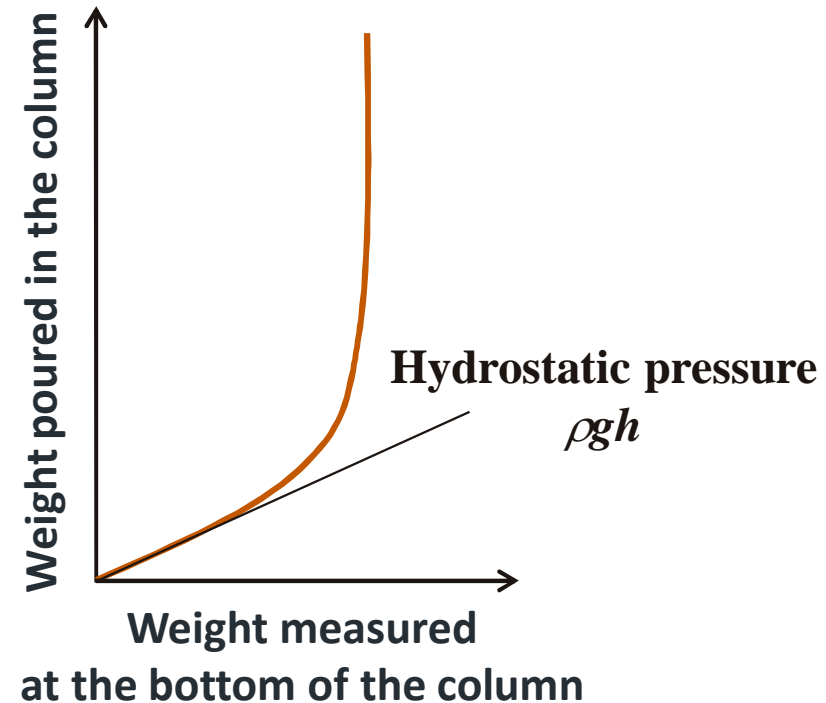
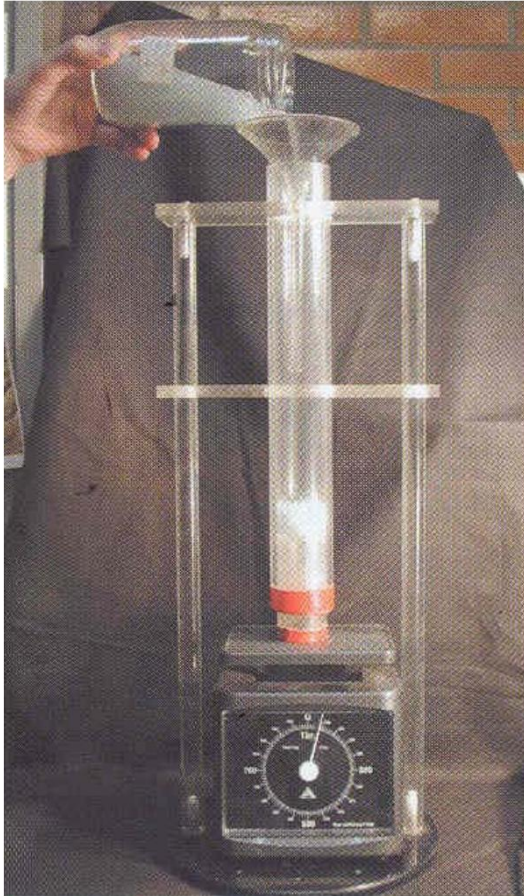

From a certain height of bed, any powder addition does not make any variation of mass weighed at the bottom

Pressure at the **bottom** of a cylindrical grain column

- 3 hypotheses:
- “ **Lateral uniformity** of the vertical stress (layer model)
 - “ The **horizontal stress** is **proportional** to the **vertical stress**
 - “ **Slipping at the wall** (Coulomb criterion)

Janssen's model

Pressure at the bottom of a cylindrical grain column

- 3 hypotheses:
- “ Lateral uniformity of the vertical stress (layer model)
 - “ The horizontal stress is proportional to the vertical stress
 - “ Slipping at the wall (Coulomb criterion)

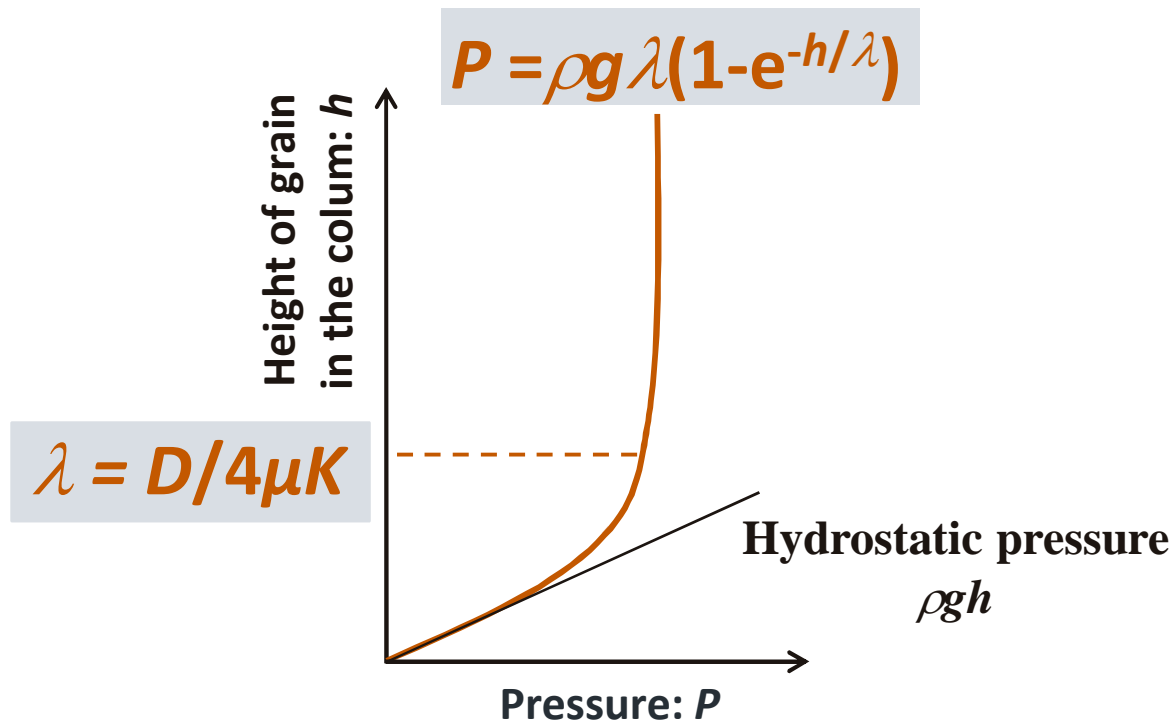

Weight deflection into lateral sides of the column

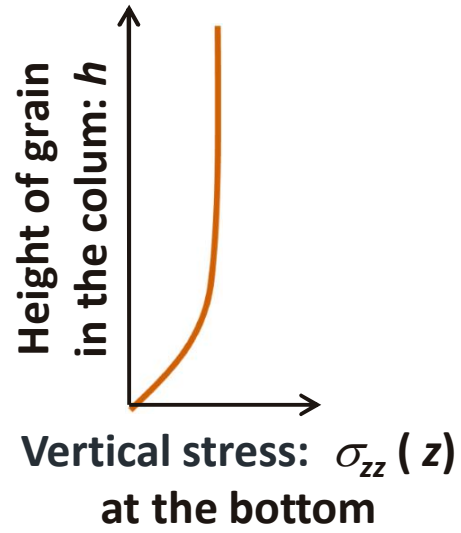
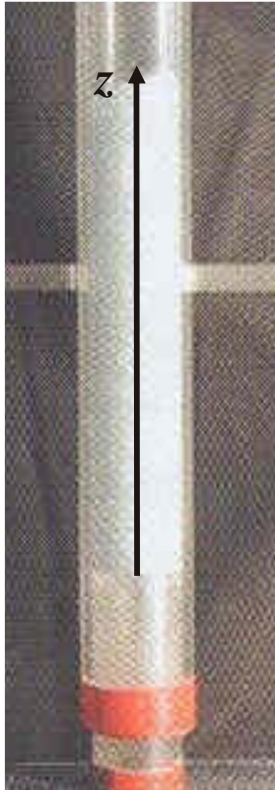

BOTTOM

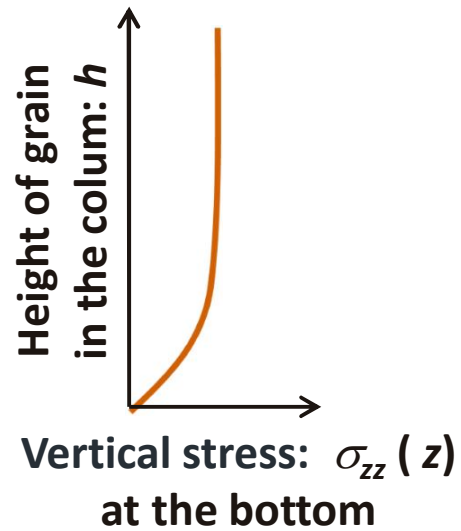
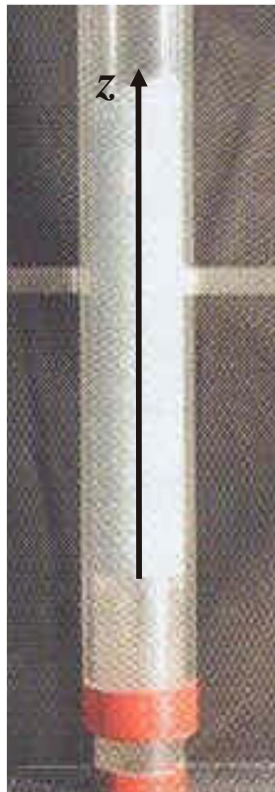

BOTTOM

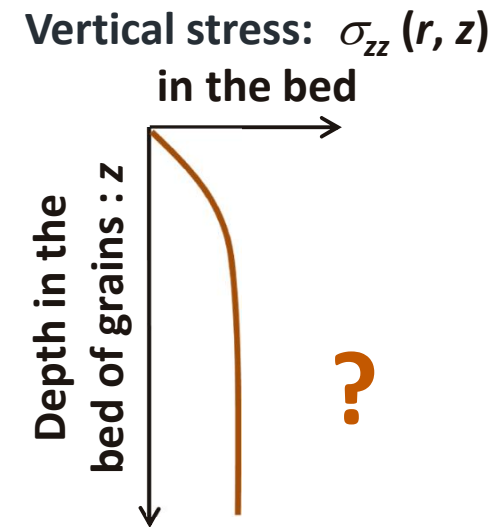
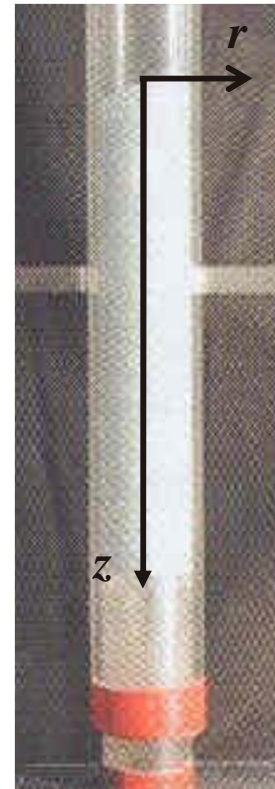

BULK

Profile of the local vertical stress in an ensiled granular media?
Effect of the particle size?

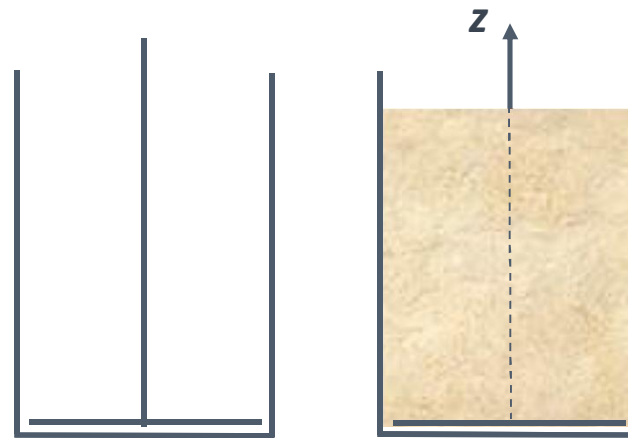
Rheological deviceJanssen's experiment: large probe

Front view
Large probe

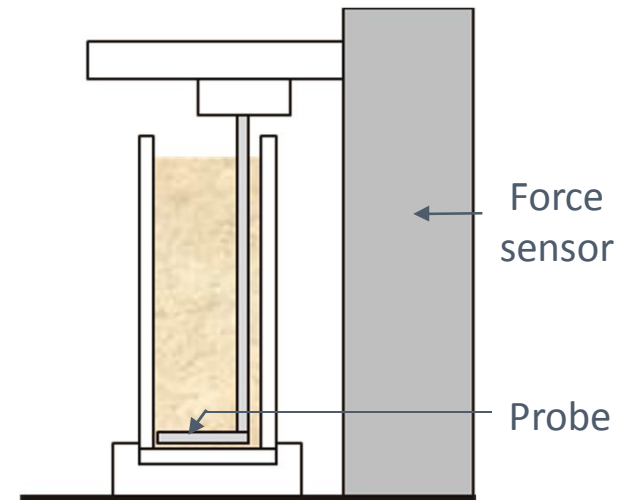

Side view
of the texture analyser

Measurement of the vertical stress
at the **bottom** of the cell
 $0 < z \leq 14$ cm (height of the bed)

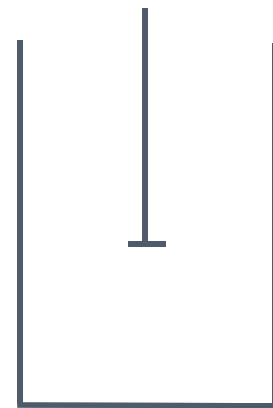
2D rheological device**Local experiment: small probe**

Front view
Small probe

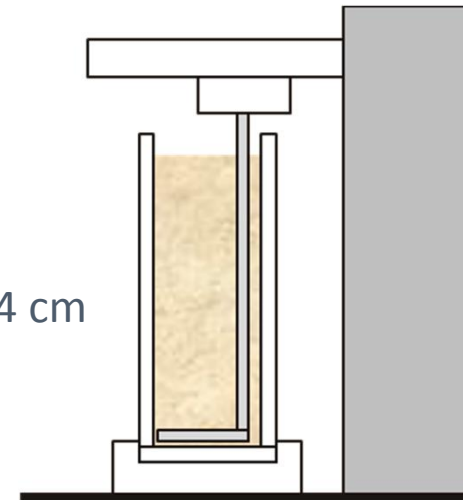
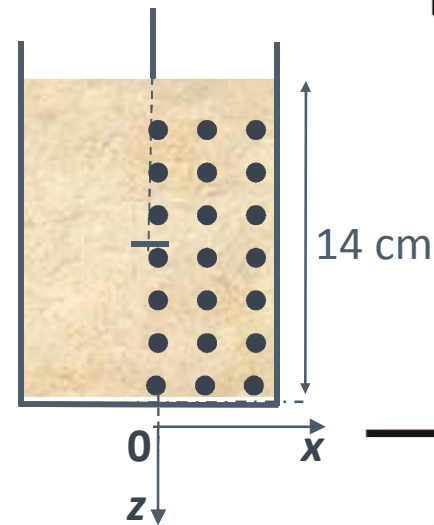

Side view
of the texture analyser

Measurement of the vertical stress
in the granular bed

$0 < x \leq 4 \text{ cm} \ \& \ 0 < z \leq 14 \text{ cm}$ (position in the bed)

2D-cartography of the local vertical stress

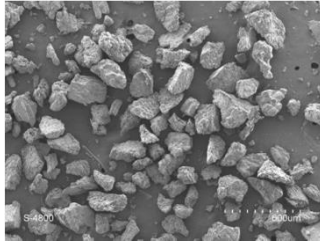
*Semolina*

Wheat-based powders

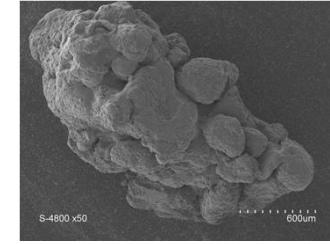
*Couscous grain*

- “ **Native powder : durum wheat semolina** (pasta, noodle, couscous...)
 - Characterisation of the local vertical stress profiles
- “ **A range of 5 wheat-based powders : native and agglomerated particles**
 - Effect of the **size** and the structure on the local vertical stress profiles

Sample Name	d_{50} (μm)	dsp
Fine semolina	210	1.53
Medium semolina	300	1.46
Fine couscous	680	0.95
Medium couscous	950	0.54
Large couscous	1100	0.37

Janssen's profile

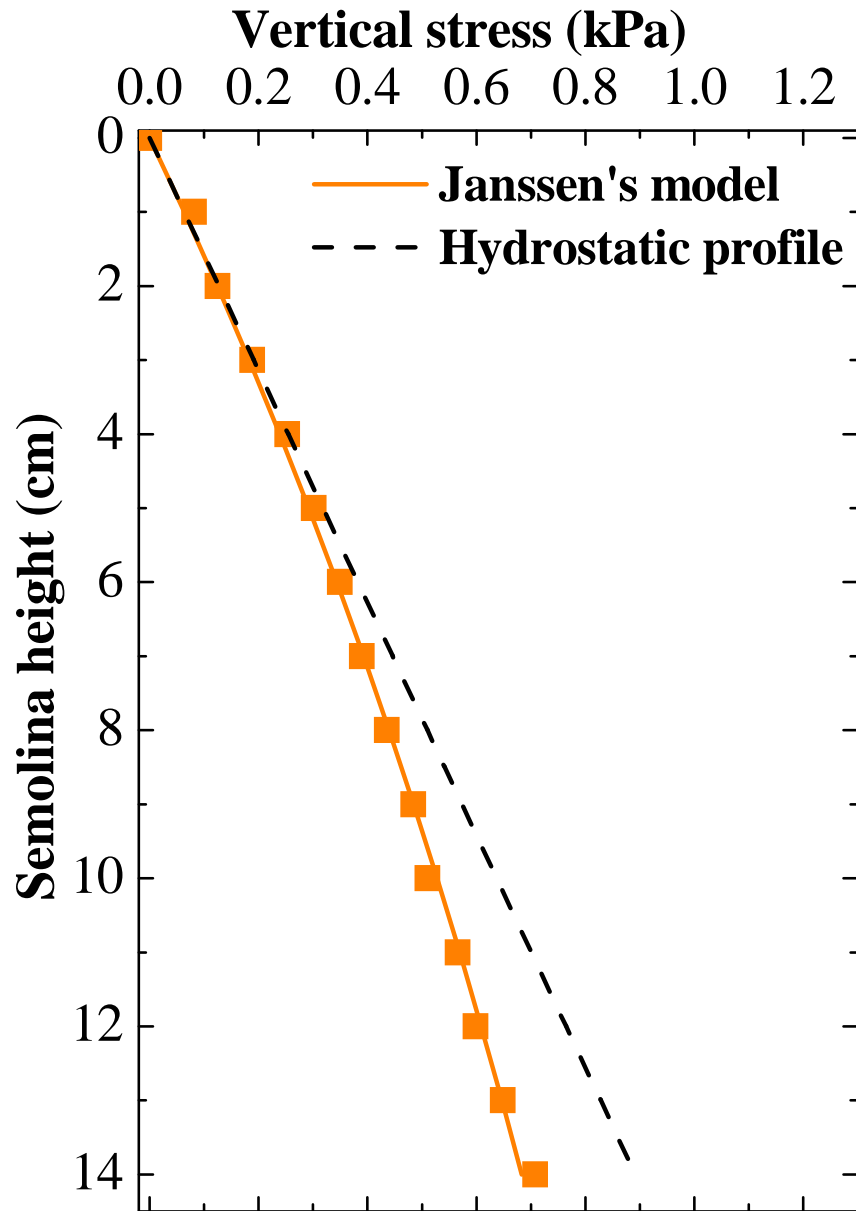

Janssen's profile:

“ Deviation from the hydrostatic profile

“ $\lambda = 23 \text{ cm}$

Screening of the weight by the lateral sides of the cell

Janssen & local vertical stress profiles in the center of the cell

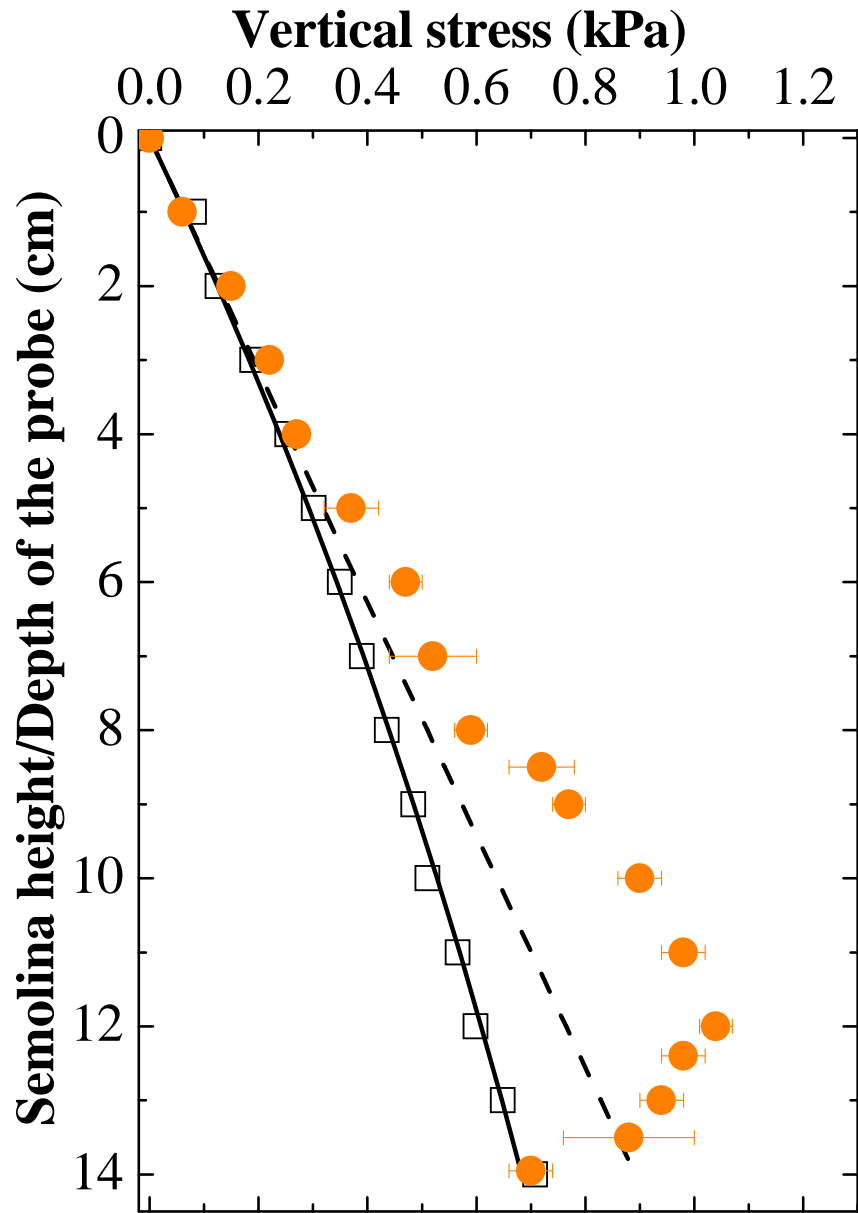

Local approach - $x=0$

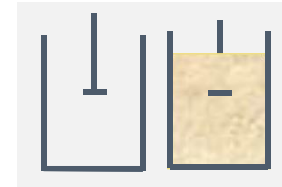

Local profile \neq Janssen's profile

Janssen & local vertical stress profiles in the center of the cell

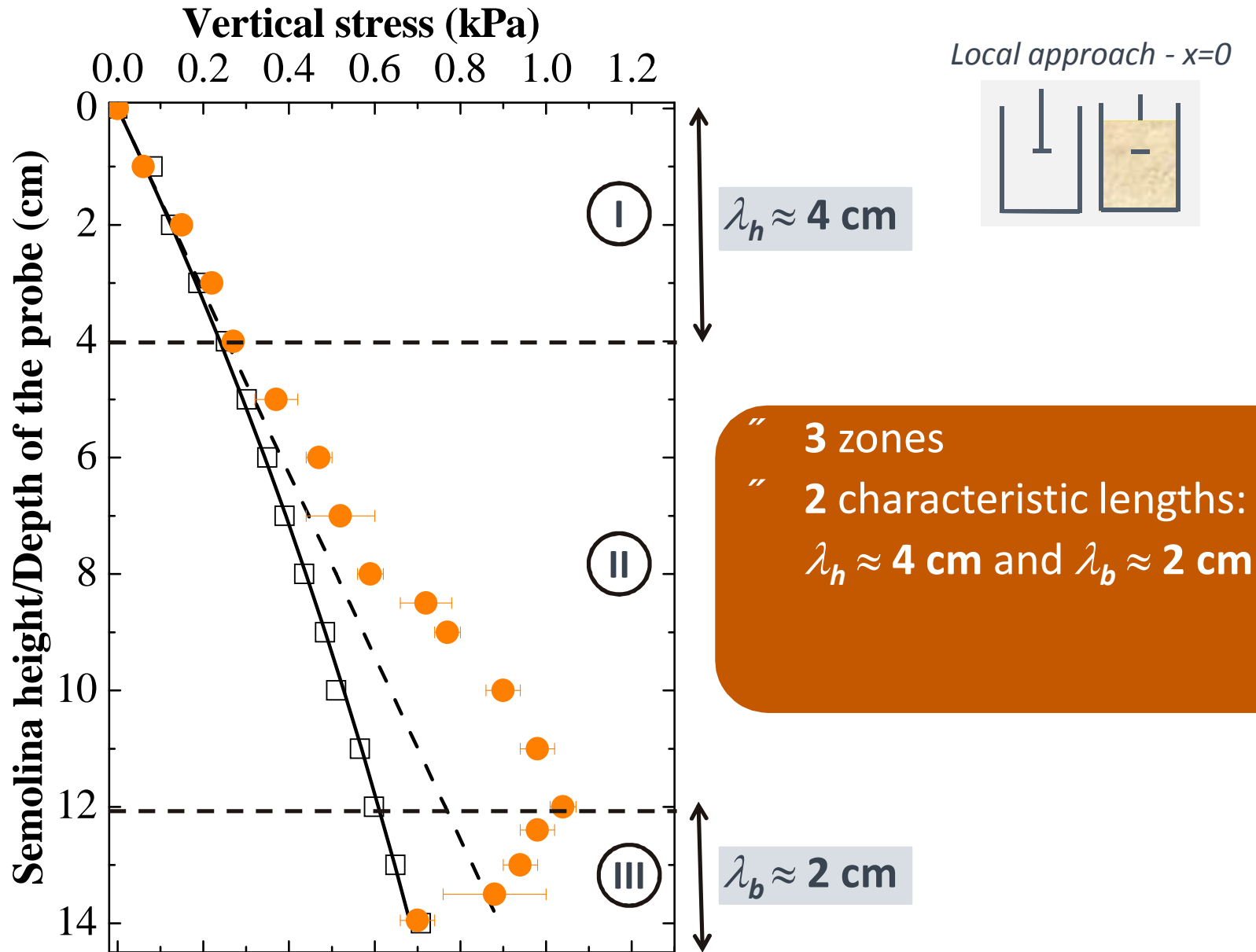

3 zones
 2 characteristic lengths:
 $\lambda_h \approx 4$ cm and $\lambda_b \approx 2$ cm

Janssen & local vertical stress profiles in the center of the cell

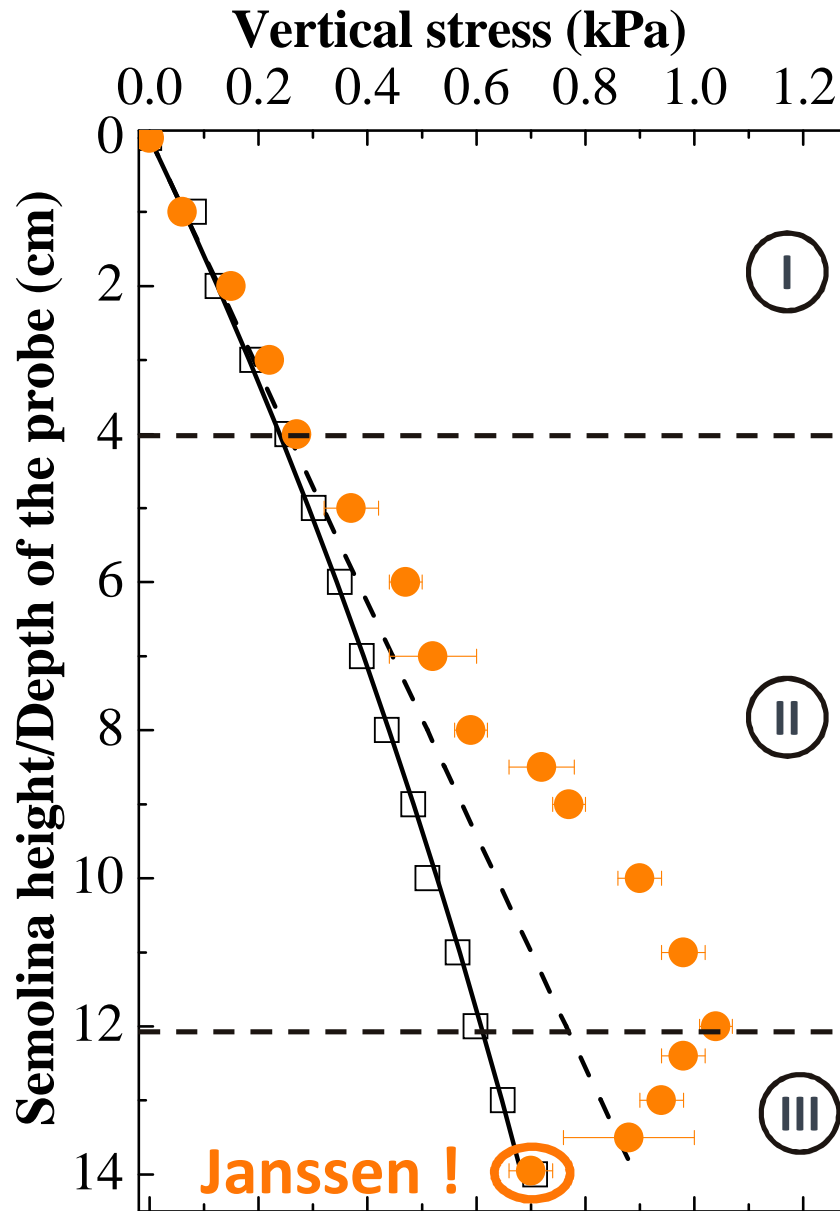

Local approach - $x=0$

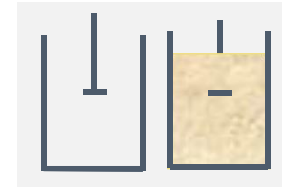

$\lambda_h \approx 4 \text{ cm}$

- ” 3 zones
- ” 2 characteristic lengths:
 $\lambda_h \approx 4 \text{ cm}$ and $\lambda_b \approx 2 \text{ cm}$
- ” Janssen value at the **bottom** of the cell !

$\lambda_b \approx 2 \text{ cm}$

Janssen & local vertical stress profiles in the center of the cell

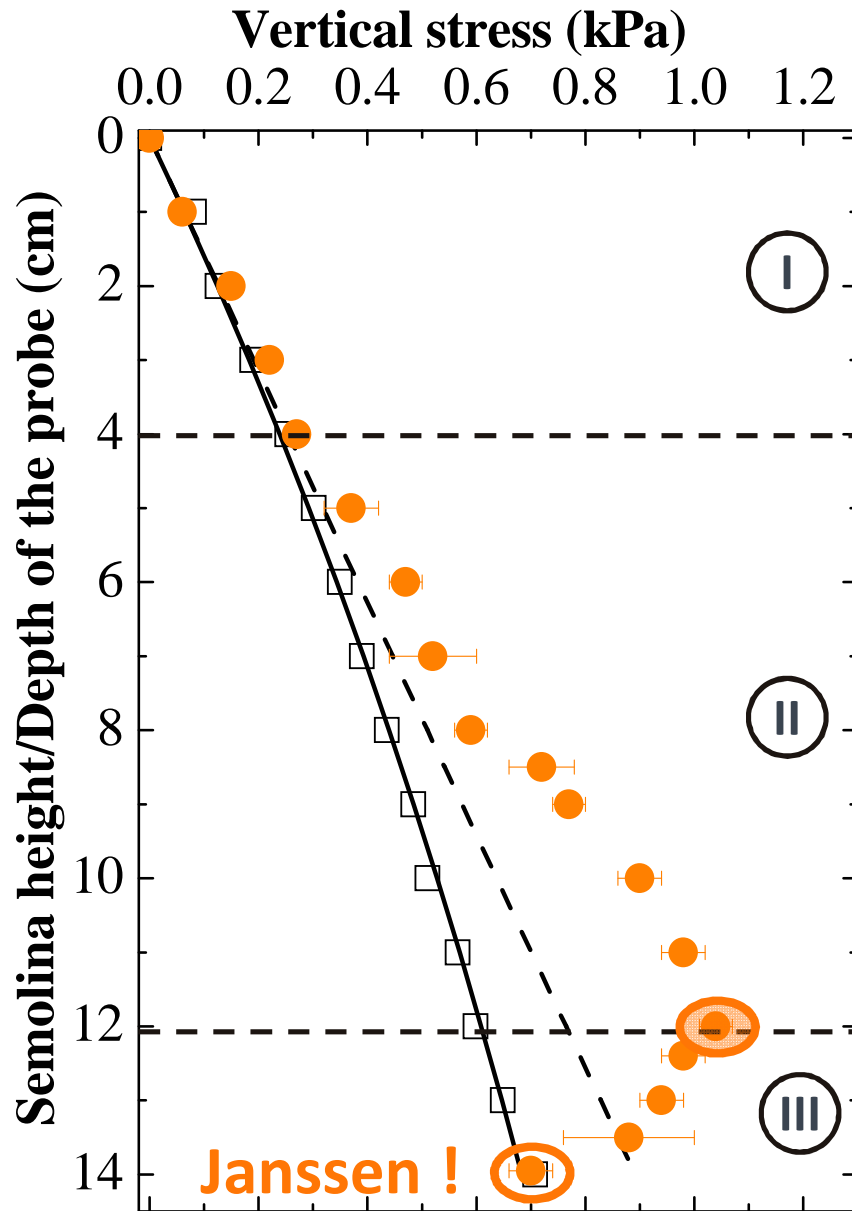

Local approach - $x=0$

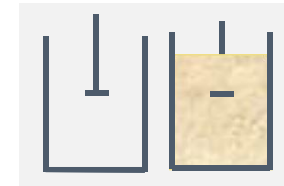

$\lambda_h \approx 4 \text{ cm}$

- ” 3 zones
- ” 2 characteristic lengths:
 $\lambda_h \approx 4 \text{ cm}$ and $\lambda_b \approx 2 \text{ cm}$
- ” Janssen value at the **bottom** of the cell !

$\lambda_b \approx 2 \text{ cm}$

Local vertical stress profiles in horizontal plane

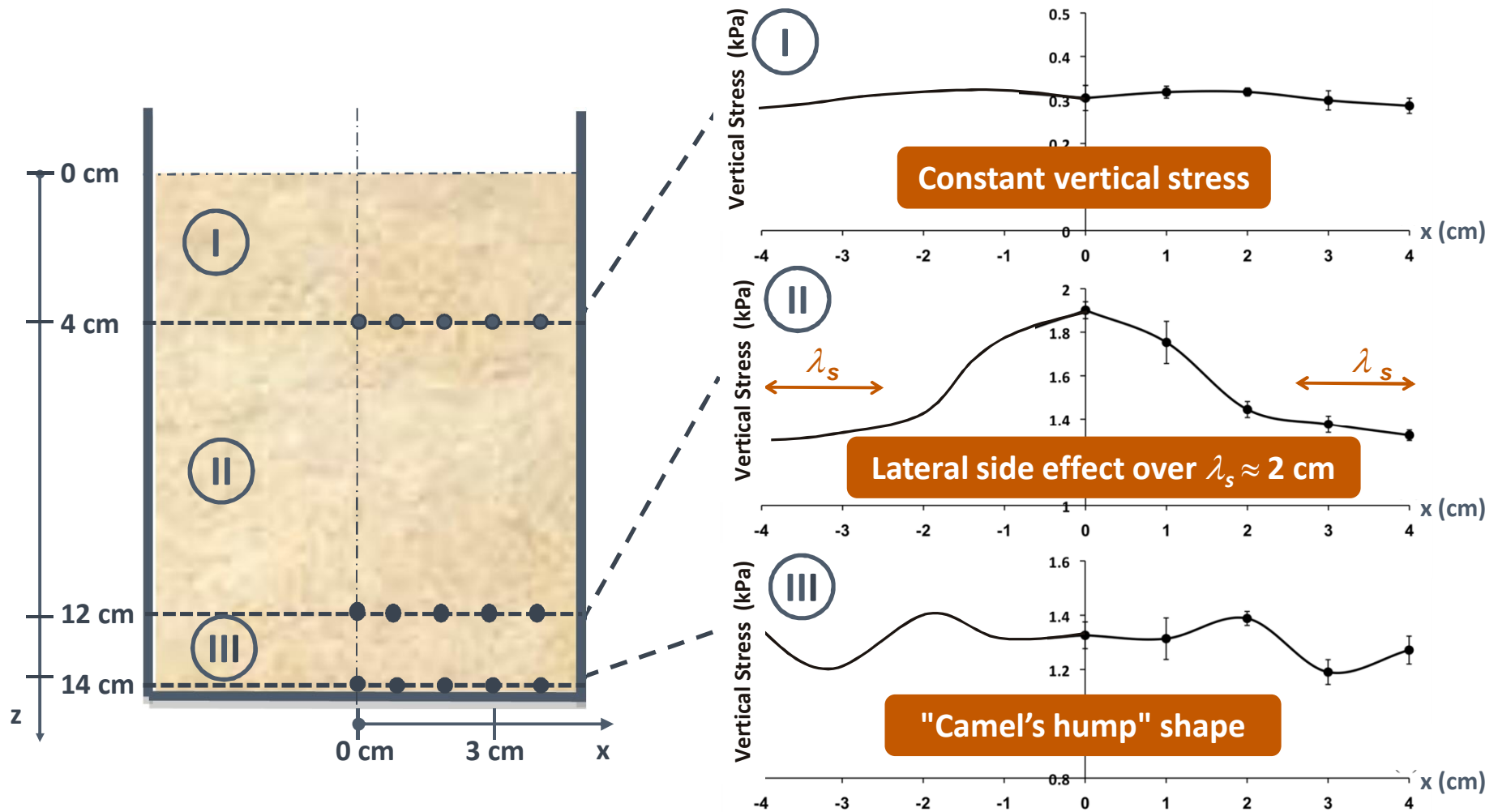

“ Zone I: Lateral uniformity of the vertical stress
 “ Zone II & III: Lateral inhomogeneity of the vertical stress
 ⇒ Janssen's hypothesis not checked for semolina

2D iso-stress cartography

Surface

*Vertical Stress
(kPa)*

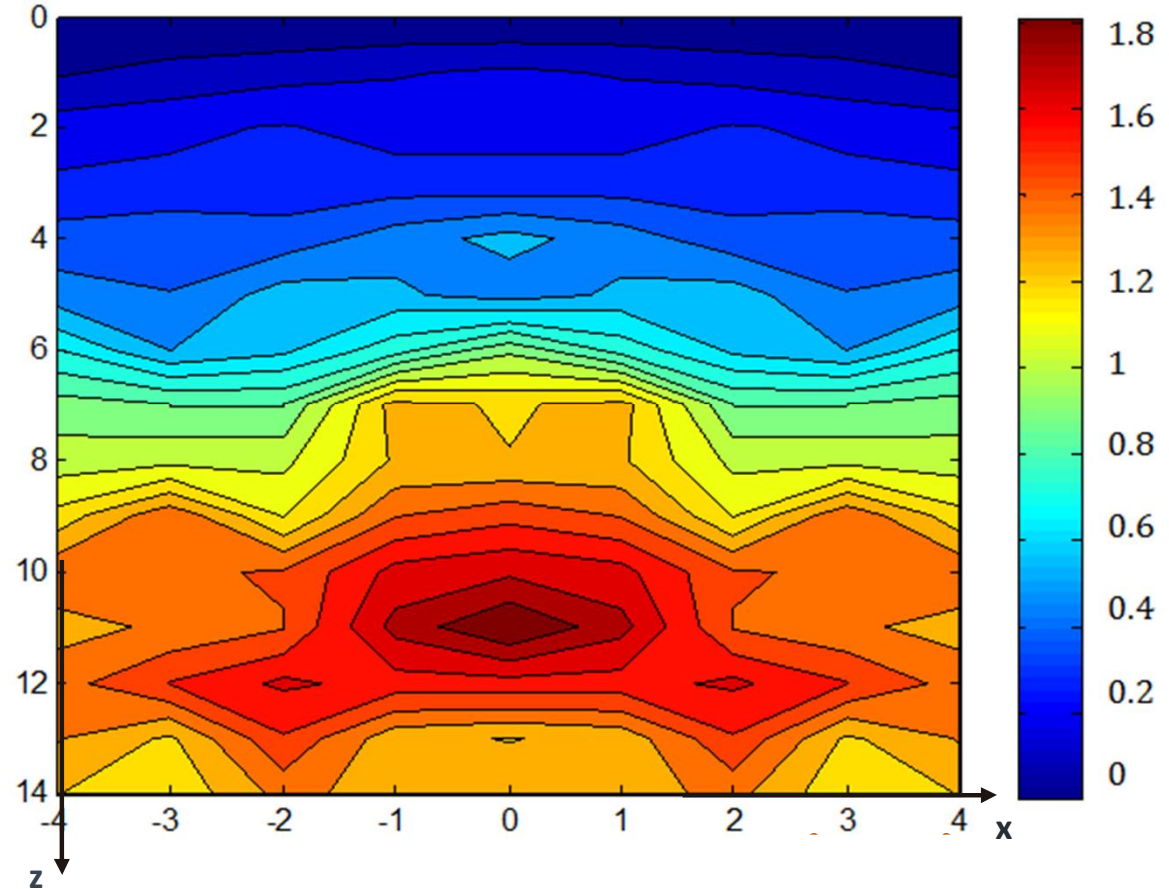

Bottom

2D iso-stress cartography

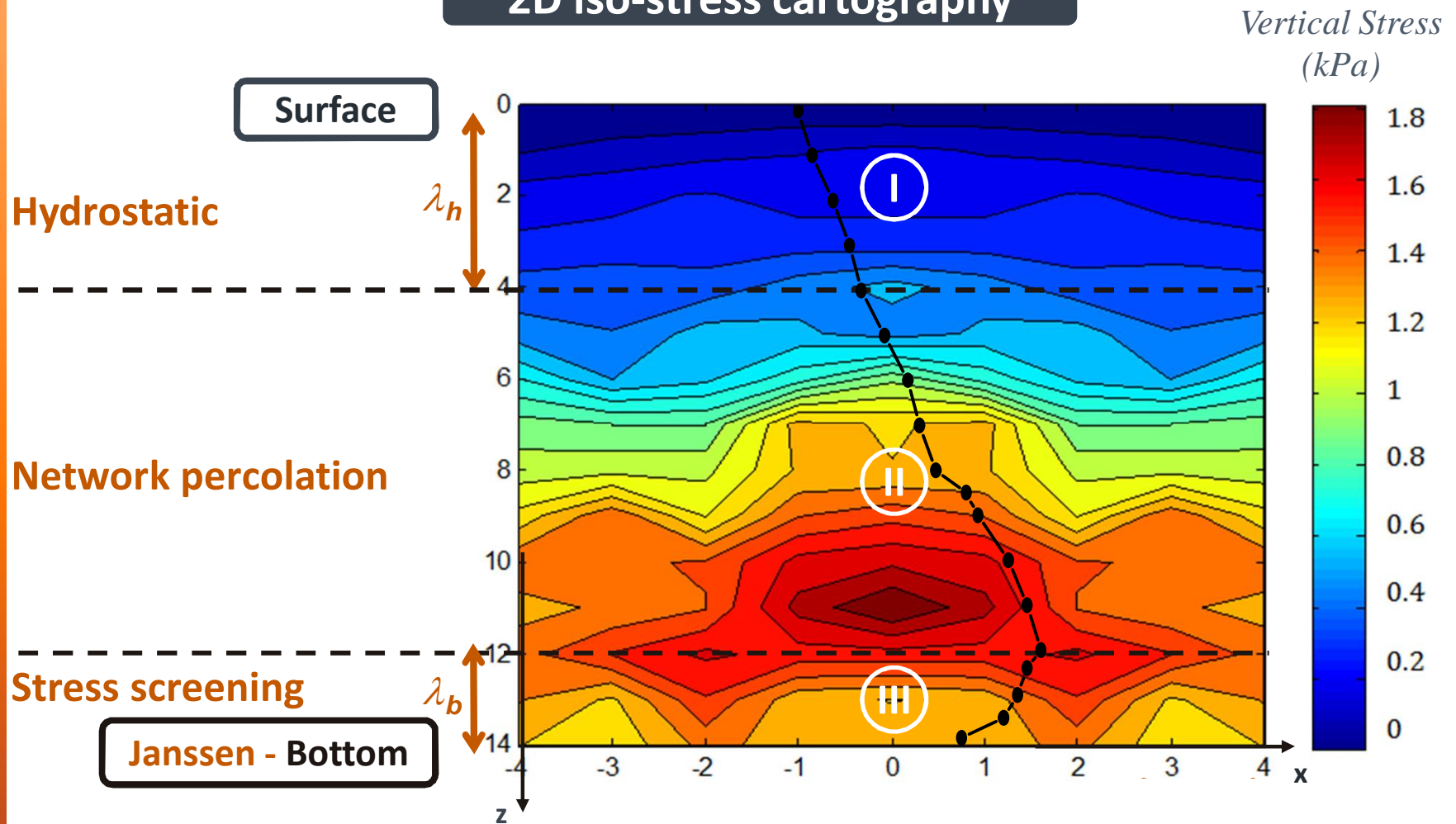

2D iso-stress cartography

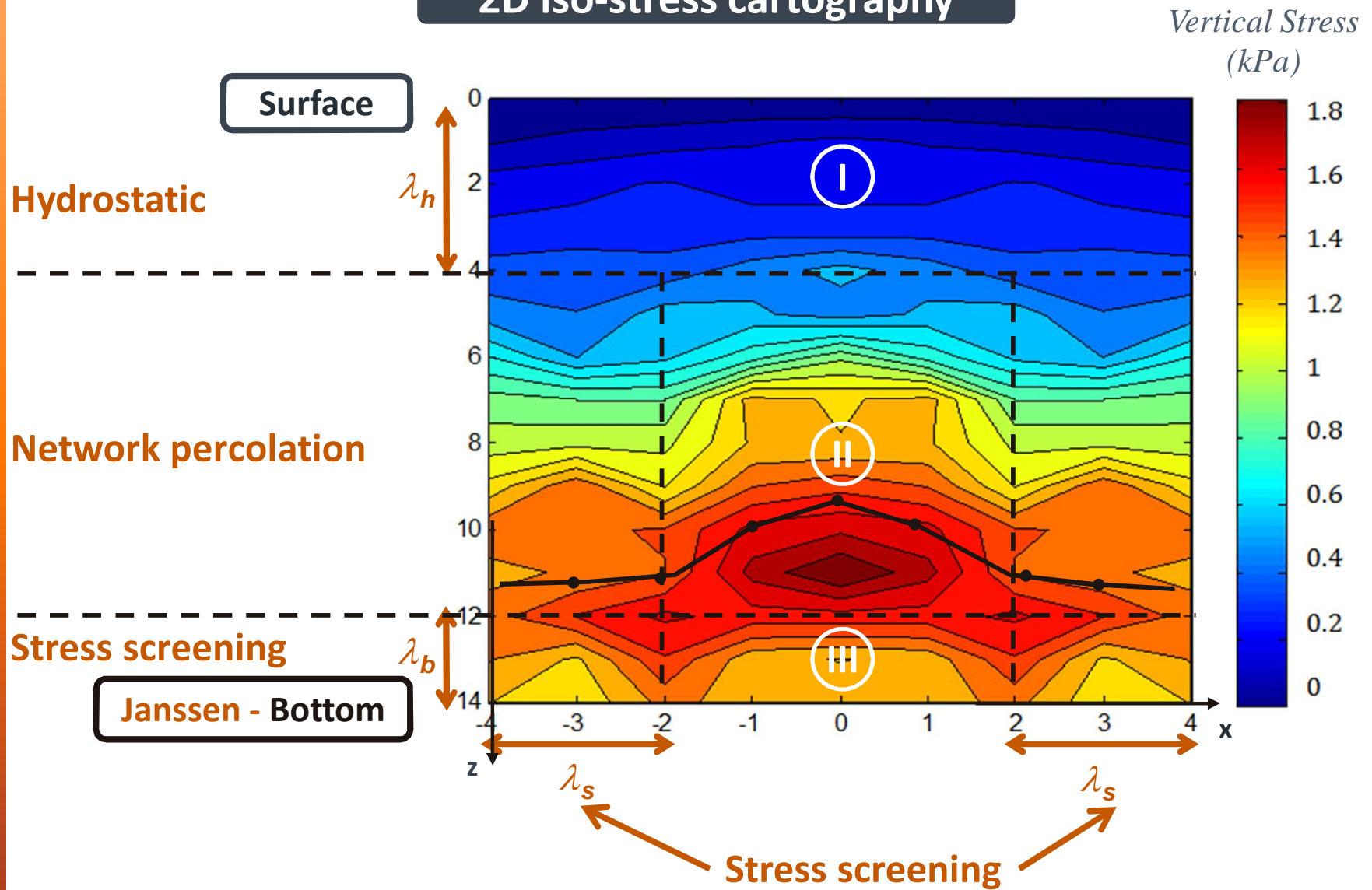

2D iso-stress cartography

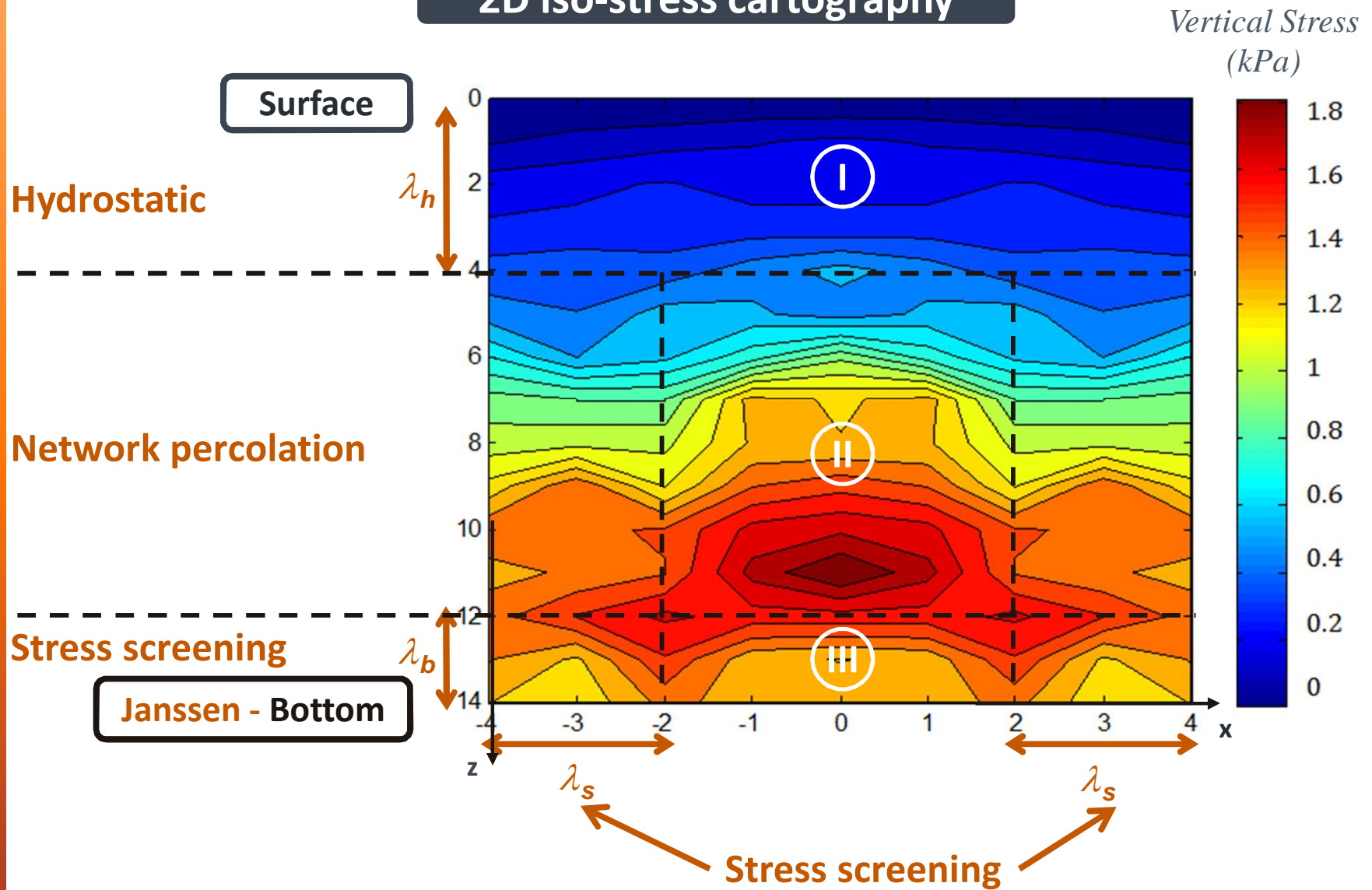

2D iso-stress cartography

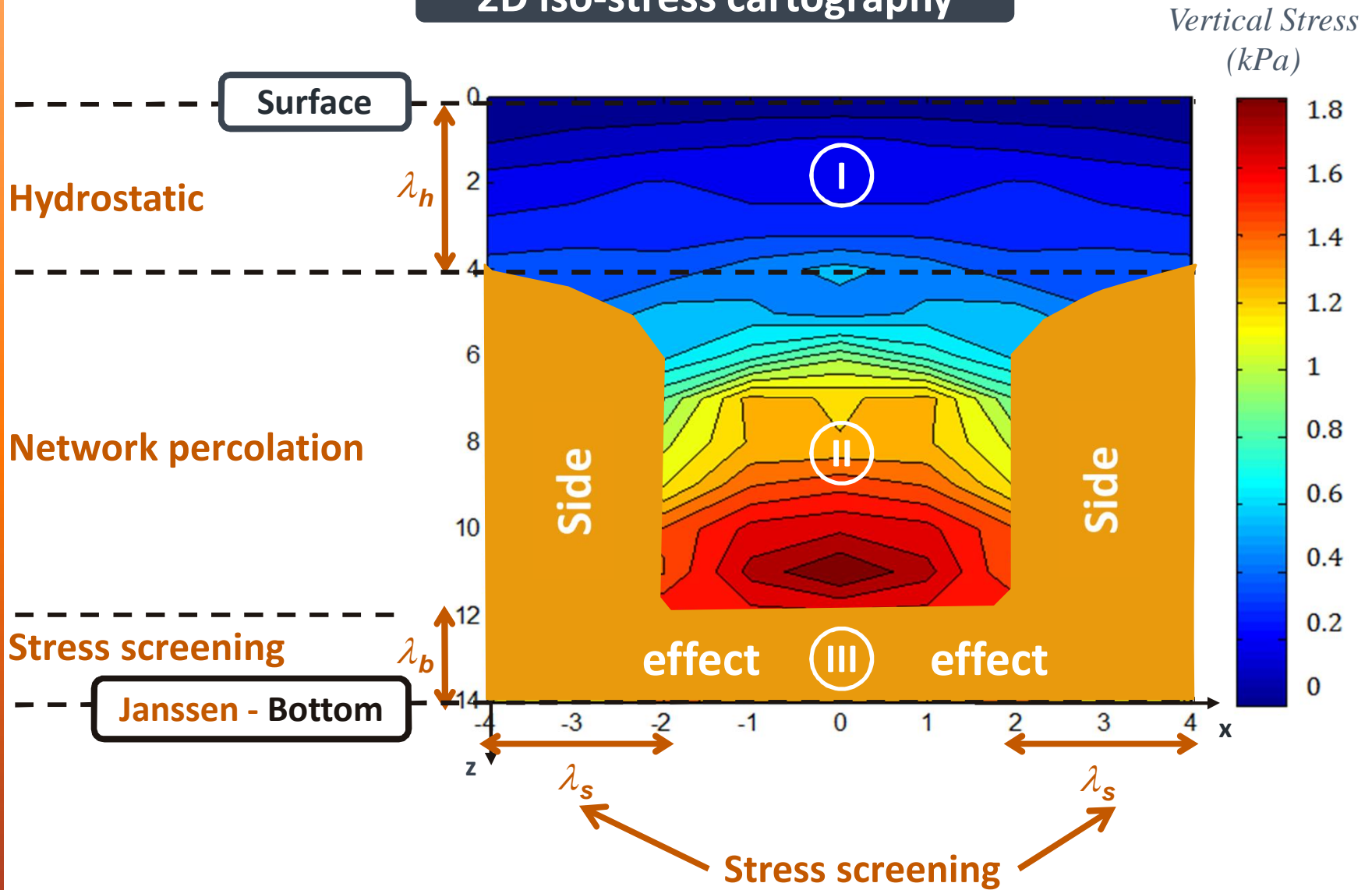

The bottom is a side as an other...

Particle size effect ?

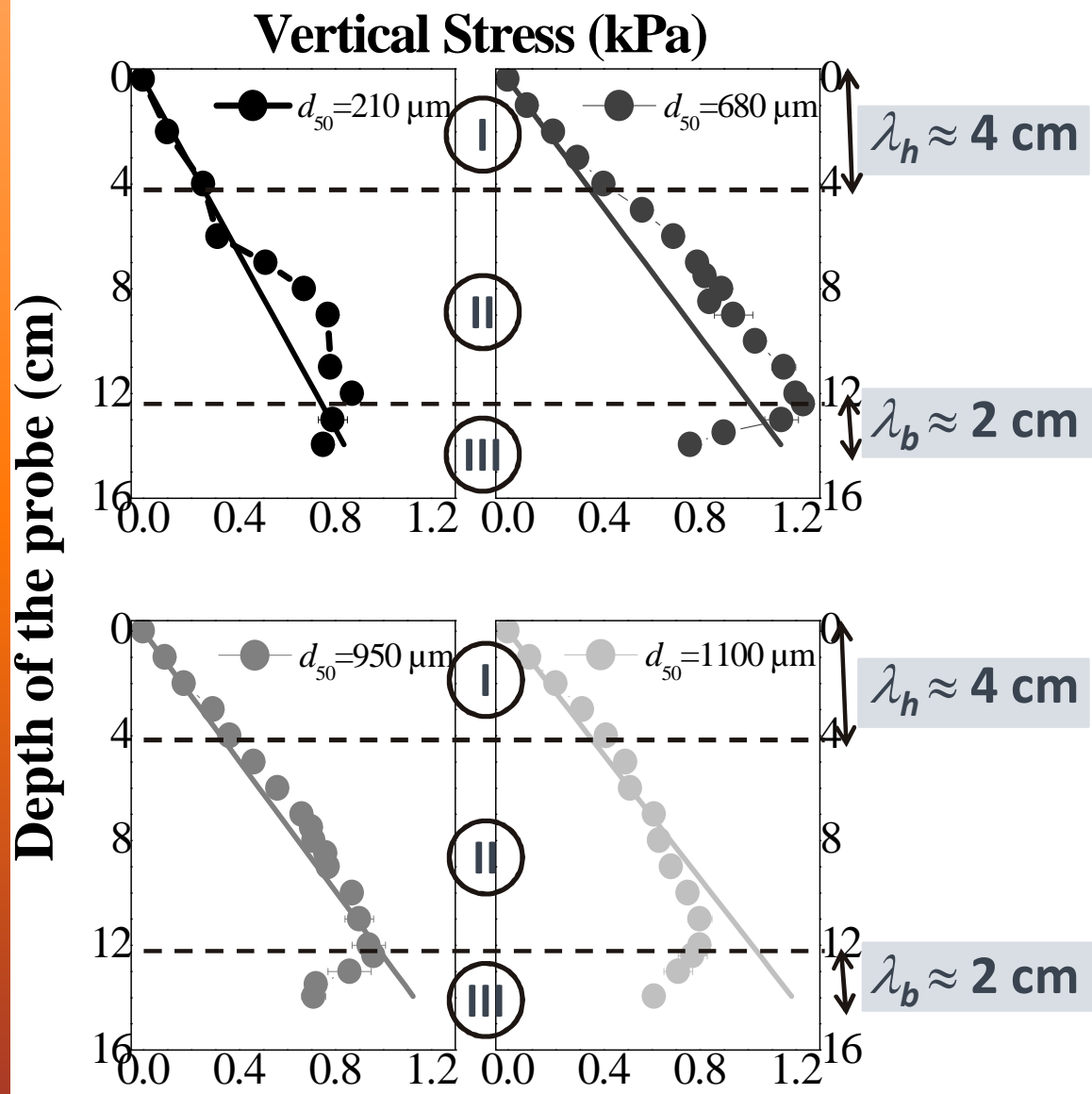

Particle size
does not affect:
" Shape of the profile
" Characteristic lengths

Particle size effect ?

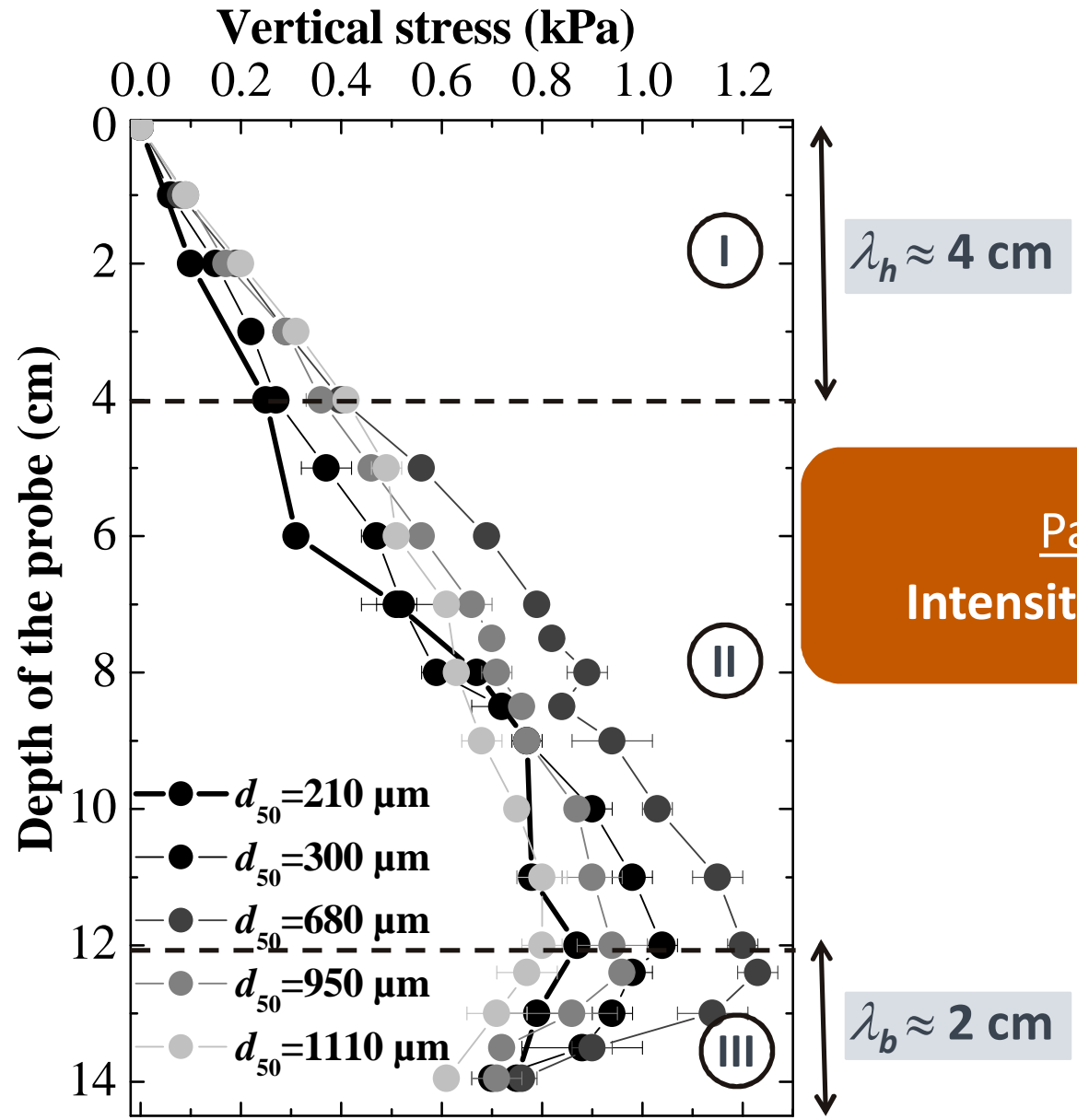

Particle size affects :
Intensity of the local vertical stress

- “ **Generic device** implementation for measuring **2D-cartography** of the **vertical stress** in **ensiled granular powders**.
- “ **Non-equivalence** between **global** and **local** vertical stress measurements **except** at the **bottom** of the cell (**semolina**).
- “ **Particle size affects** the **intensity** of the **local vertical stress** but **not** the **shape** of the vertical stress profile and the **characteristic lengths**.

WCPT 7

T1.2 Particle property and inter-particle force characterization

Thank you for you attention

**Stress distribution inside powder bed:
does Janssen's model applicable locally
in a granular medium?**

Sandra Mandato, Agnès Duri^{*}, Bernard Cuq and Thierry Ruiz

UMR IATE

<http://umr-iate.cirad.fr/>

2 Place Pierre Viala - 34000 Montpellier – FRANCE



* duri@supagro.inra.fr