



HAL
open science

Transport and catabolism of pentitols by *Listeria monocytogenes*

Takfarinas Kentache, Eliane Milohanic, Nguyen Thanh Nguyen Cao, Abdelhamid Mokhtari, Françoise Ake, Que Mai Ma Pham, Philippe Joyet, Josef Deutscher

► **To cite this version:**

Takfarinas Kentache, Eliane Milohanic, Nguyen Thanh Nguyen Cao, Abdelhamid Mokhtari, Françoise Ake, et al.. Transport and catabolism of pentitols by *Listeria monocytogenes*. *Journal of Molecular Microbiology and Biotechnology*, 2016, 26 (6), pp.369-380. 10.1159/000447774 . hal-01602226

HAL Id: hal-01602226

<https://hal.science/hal-01602226>

Submitted on 27 May 2020

HAL is a multi-disciplinary open access archive for the deposit and dissemination of scientific research documents, whether they are published or not. The documents may come from teaching and research institutions in France or abroad, or from public or private research centers.

L'archive ouverte pluridisciplinaire **HAL**, est destinée au dépôt et à la diffusion de documents scientifiques de niveau recherche, publiés ou non, émanant des établissements d'enseignement et de recherche français ou étrangers, des laboratoires publics ou privés.

Transport and Catabolism of Pentitols by *Listeria monocytogenes*

Takfarinas Kentache^a Eliane Milohanic^a Thanh Nguyen Cao^a
Abdelhamid Mokhtari^{a, b} Francine Moussan Aké^a Que Mai Ma Pham^a
Philippe Joyet^a Josef Deutscher^{a, c}

^aMicalis Institute, INRA, AgroParisTech, Université Paris-Saclay, Jouy-en-Josas, France; ^bDepartment of Biology, 8 May 1945 University, Guelma, Algeria; ^cCentre National de la Recherche Scientifique, UMR8261 (affiliated with Univ. Paris Diderot, Sorbonne Paris Cité), Expression Génétique Microbienne, Institut de Biologie Physico-Chimique, Paris, France

Key Words

Listeria monocytogenes · D-Arabitol utilization · D-Xylitol utilization · Phosphotransferase system · Virulence gene repression

Abstract

Transposon insertion into *Listeria monocytogenes* *Imo2665*, which encodes an EIIc of the phosphoenolpyruvate:carbohydrate phosphotransferase system (PTS), was found to prevent D-arabitol utilization. We confirm this result with a deletion mutant and show that *Lmo2665* is also required for D-xylitol utilization. We therefore called this protein EIIc^{Axl}. Both pentitols are probably catabolized via the pentose phosphate pathway (PPP) because *Imo2665* belongs to an operon, which encodes the three PTS^{Axl} components, two sugar-P dehydrogenases, and most PPP enzymes. The two dehydrogenases oxidize the pentitol-phosphates produced during PTS-catalyzed transport to the PPP intermediate xylose-5-P. *L. monocytogenes* contains another PTS, which exhibits significant sequence identity to PTS^{Axl}. Its genes are also part of an operon encoding PPP enzymes. Deletion of

the EIIc-encoding gene (*Imo0508*) affected neither D-arabitol nor D-xylitol utilization, although D-arabitol induces the expression of this operon. Both operons are controlled by MtlR/LicR-type transcription activators (*Lmo2668* and *Lmo0501*, respectively). Phosphorylation of *Lmo0501* by the soluble PTS^{Axl} components probably explains why D-arabitol also induces the second pentitol operon. Listerial virulence genes are submitted to strong repression by PTS sugars, such as glucose. However, D-arabitol inhibited virulence gene expression only at high concentrations, probably owing to its less efficient utilization compared to glucose.

© 2016 S. Karger AG, Basel

Introduction

D-Ribitol, D-xylitol, and D-arabitol are the three major naturally occurring pentitols. D-Arabitol (also called D-arabinitol and D-lyxitol) is relatively abundant in nature and is produced by lichens and fungi. Bacteria from most phyla, such as the proteobacteria *Klebsiella pneumoniae* [Heuel et al., 1997] and *Pseudomonas fluorescens* [Brünker

et al., 1998], the actinobacterium *Corynebacterium glutamicum* [Laslo et al., 2012], and the firmicutes *Enterococcus avium* [Povelainen et al., 2003] and *Listeria monocytogenes* [Saklani-Jusforgues et al., 2001] utilize D-arabitol as a carbon and energy source. The γ -proteobacterium *K. pneumoniae* and the actinobacterium *C. glutamicum* take up D-arabitol via closely related transporters of the major facilitator superfamily (DalT and RbtT, respectively). D-Arabitol 4-dehydrogenases with significant similarity to mannitol-1-P dehydrogenases subsequently oxidize intracellular D-arabitol to D-xylulose [Heuel et al., 1997]. The γ -proteobacterium *P. fluorescens* transports D-arabitol via an ABC transporter of broad substrate specificity, which also recognizes D-mannitol and D-glucitol. The ABC transporter is composed of the binding protein MtlE, the two membrane-spanning transport proteins MtlF and MtlG, and the ATP hydrolyzing protein MtlK [Brünker et al., 1998]. A gene encoding a polyol dehydrogenase (MtlD) is also present in the *P. fluorescens* operon. MtlD has the highest affinity for D-arabitol and converts the pentitol to D-xylulose. With lower efficiency it transforms D-mannitol and D-glucitol into D-fructose [Brünker et al., 1997].

In contrast to proteobacteria and actinobacteria, firmicutes transport pentitols via a phosphoenolpyruvate:glycose phosphotransferase system (PTS) either of the galactitol or the mannose family. The galactitol PTSs are usually composed of two cytoplasmic substrate-specific proteins (EIIA and EIIB) and the integral membrane protein EIIC. PTSs of the mannose family contain a second membrane protein, EIID. Together with the general PTS components EI and HPr, the two soluble carbohydrate-specific proteins form a phosphorylation cascade. In the first step, EI autophosphorylates at a conserved histidyl residue by using phosphoenolpyruvate as phosphoryl donor [Alpert et al., 1985]. P~EI transfers the phosphoryl group to His-15 in HPr, and P~His-HPr phosphorylates one of usually several different carbohydrate-specific EIIA proteins present in a bacterium. P~EIAs, which are also phosphorylated at histidine residues [Deutscher et al., 1982], usually transfer the phosphoryl group to a conserved Cys residue of their cognate EIIB [Volpon et al., 2006]. Only EIIBs of the mannose family are phosphorylated at a histidyl residue. In the last step, P~EIIB donates its phosphoryl group to the carbohydrate bound to the cytoplasmic side of the corresponding membrane-spanning EIIC [Cao et al., 2011]. Phosphorylation of the carbohydrate probably lowers its affinity for the EIIC and the phosphorylated carbohydrate is released into the cytoplasm.

The first evidence for PTS-catalyzed transport of pentitols came from studies with *Lactobacillus casei* strains

able to utilize D-ribitol and D-xylitol. They contain D-ribitol-5-P and D-xylitol-5-P dehydrogenases [Hausman and London, 1987], which suggested that these pentitols are taken up by PTSs. Indeed, an EII component specific for xylitol was purified from *L. casei* strain Cl83 [London and Hausman, 1983]. In addition, the D-ribitol-specific mannose-type PTS of *L. casei*, which contains two membrane-spanning components (EIIC^{Rtl} and EIID^{Rtl}), has recently been characterized [Bourand et al., 2013]. Interestingly, D-xylitol-5-P dehydrogenase purified from *L. casei* was also able to efficiently oxidize D-arabitol-5-P [Hausman and London, 1987], which is one of the two possible products of PTS-catalyzed transport and phosphorylation. However, no *L. casei* strain has been reported to utilize D-arabitol. In fact, *L. monocytogenes* was the first firmicute for which PTS-catalyzed transport of D-arabitol was suggested [Saklani-Jusforgues et al., 2001]. Later, *E. avium* was reported to possess a D-arabitol-phosphate dehydrogenase, ApdH, which converts both possible products of PTS-catalyzed D-arabitol phosphorylation, D-arabitol-1-P and D-arabitol-5-P, into the pentose phosphate pathway (PPP) intermediates D-xylulose-5-P and D-ribulose-5-P, respectively [Povelainen et al., 2003]. The *apdH* gene is part of an operon including also the genes for a PTS of the galactitol family (fig. 1c). ApdH exhibits significant similarity to the *L. monocytogenes* proteins Lmo2663 and Lmo2664, the genes of which are also part of an operon encoding a galactitol type PTS (fig. 1a). Interestingly, insertion of a transposon into *lmo2665*, which encodes an EIIC of the galactitol family [Barabote and Saier, 2005], prevented *L. monocytogenes* from fermenting D-arabitol [Saklani-Jusforgues et al., 2001].

L. monocytogenes possesses a second operon encoding an ApdH-like protein (Lmo0505) and a potential pentitol PTS. We therefore decided to characterize pentitol transport and metabolism in this pathogen in more detail. We also studied the effect of D-arabitol utilization on virulence gene expression. Glucose, which is mainly metabolized via the PPP [Eisenreich et al., 2006], and other PTS substrates strongly repress PrfA-regulated virulence gene expression [Milenbachs et al., 1997; Park and Kroll, 1993; Scortti et al., 2007]. The non-PTS carbon sources glycerol [Zébré et al., 2015] and maltose [Deutscher et al., 2014a] have no repressive effect. PTS components were therefore thought to play a role in carbohydrate-mediated PrfA regulation [Herro et al., 2005; Mertins et al., 2007]. Because D-arabitol is a PTS substrate probably also mainly metabolized via the PPP, we tested whether D-arabitol would also exert virulence gene repression.

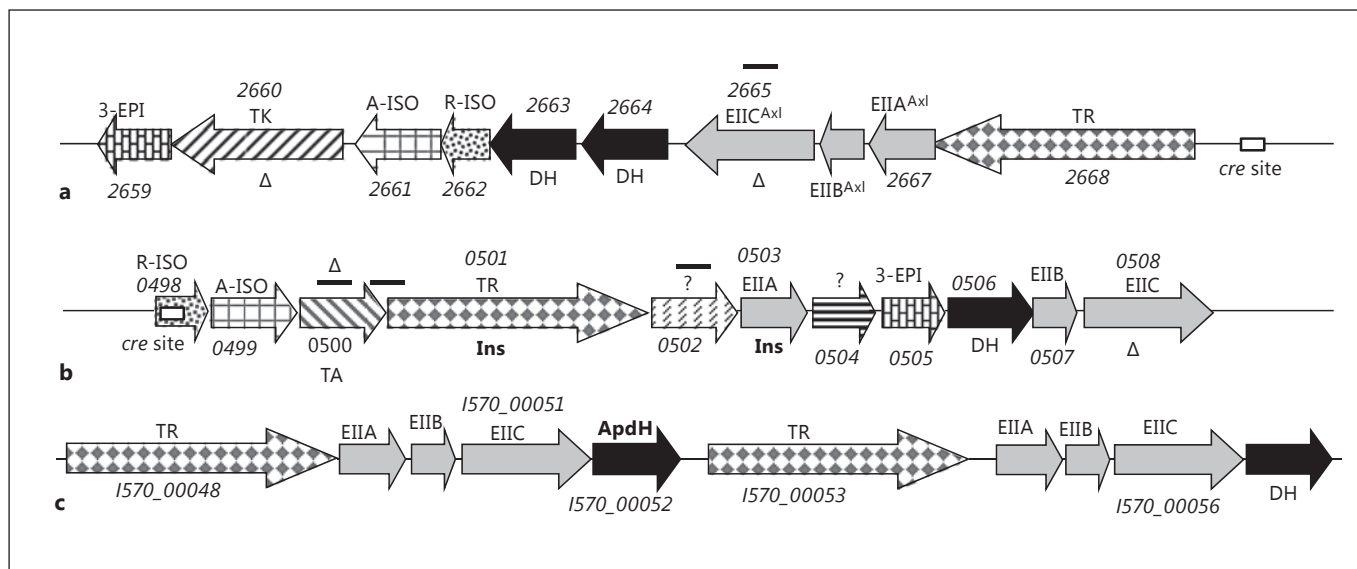

Fig. 1. Gene organization of the two D-arabitol-induced operons in *L. monocytogenes* (**a**, **b**) and the D-arabitol operon of *E. avium* (**c**). The genes encoding the PTS proteins are presented as grey arrows and the pentitol dehydrogenases as black arrows. A-ISO = Arabinose-5-P isomerase; DH = D-arabitol-1-P/D-xylitol-5-P dehydrogenases; 3-EPI = ribulose-5-P 3-epimerases; R-ISO = ribulose-5-P isomerases; TK = transketolase; TA = transaldolase; TR = PRD-containing MtlR-like transcription activators. The genes

lmo0502 and *0504* encode proteins of unknown function. Δ indicates the genes which were deleted and 'Ins' those which were disrupted by plasmid insertion. Bars represent the regions amplified during qRT-PCR experiments. The numbers in **a** and **b** indicate the gene names (*lmo2659*, etc.) of strain EGD-e on the ListiList web server. The numbers in **c** correspond to the locus tag (*1570_00048*, etc.) of *E. avium* strain ATCC 14025.

Results and Discussion

Deletion of the EIIC-Encoding *lmo2665* Gene Prevents D-Arabitol Utilization

The previously reported insertion of a transposon into *lmo2665* (fig. 1a), which encodes an EIIC PTS component of the galactitol family, caused a total loss of D-arabitol fermentation [Saklani-Jusforgues et al., 2001]. In order to avoid the polar effects associated with the transposon insertion, we constructed a mutant carrying an in-frame deletion of the *lmo2665* gene. Identical to the transposon insertion mutant, the Δ *lmo2665* mutant had also lost the capacity to grow on D-arabitol as the sole carbon source (fig. 2c), but grew normally on glucose and glycerol (fig. 2a, b). This result suggested that Lmo2665 is the main protein catalyzing the uptake of D-arabitol. A Δ *ptsI* mutant (lacks the general PTS component EI) [Aké et al., 2011] was also not able to grow on D-arabitol (data not shown), thus confirming the PTS-mediated D-arabitol uptake.

Two Pentitol-P Dehydrogenases Are Encoded by the Presumed D-Arabitol Operon *lmo2668*–*lmo2659*

To determine whether the genes downstream from *lmo2665* (fig. 1a) encode enzymes involved in D-arabitol metabolism, we purified several of them as described in Experimental Procedures (online suppl. fig. S1; see www.karger.com/doi/10.1159/000447774 for all online suppl. material). We first tested the activity of the two enzymes Lmo2663 and Lmo2664, which exhibit significant identity (up to 65%) to the *E. avium* D-arabitol-phosphate dehydrogenase ApdH, which reduces D-xylulose-5-P to D-arabitol-1-P and D-ribulose-5-P to D-arabitol-5-P [Povelainen et al., 2003]. The two listerial enzymes reduce D-xylulose-5-P (table 1), but only Lmo2664 was also able to slowly reduce D-ribulose-5-P (fig. 3; table 1). Reduction of D-ribulose-5-P by Lmo2664 must lead to the formation of D-arabitol-5-P because the enzyme was not able to oxidize D-ribitol-5-P to D-ribulose-5-P. The activity of Lmo2664 therefore strongly resembles that of ApdH [Povelainen et al., 2003]. However, in contrast to ApdH, none of the two listerial enzymes could use NADPH as a reducing substrate. The addition of 10 mM EDTA to the assay mixture almost completely inhibited the dehydro-

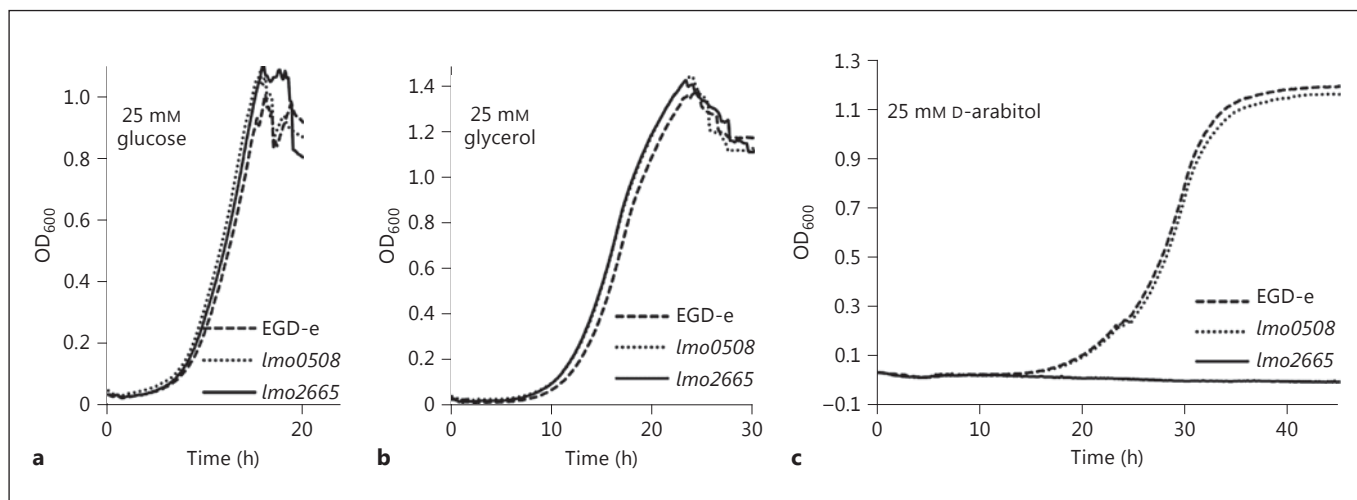

Fig. 2. Growth of *L. monocytogenes* strains on various carbon sources measured with a BioTek microplate reader. The *L. monocytogenes* wild-type strain EGD-e and the $\Delta lmo0508$ and $\Delta lmo2665$ mutants derived from it were grown in MM containing 25 mM of

either glucose (a), glycerol (b), or D-arabitol (c). While the three strains grew nearly identical in glucose- and glycerol-containing media, the $\Delta lmo2665$ mutant had lost the capacity to grow on D-arabitol.

Table 1. Enzyme activities of purified proteins

Gene	Enzyme activity measured	Specific activity, $\mu\text{mol}/\text{min}$ and mg protein
<i>lmo0499</i>	D-Arabinose-5-P isomerase	0.23
<i>lmo0505</i>	D-Ribulose-5-P 3-epimerase	1.27
<i>lmo0506</i>	D-Xylulose-5-P 2-reductase (Zn^{2+}) ^a	0.19
<i>lmo0506</i>	D-Ribulose-5-P 2-reductase (forms D-ribitol-5-P)	0.07
<i>lmo2659</i>	D-Ribulose-5-P 3-epimerase	4.91
<i>lmo2661</i>	D-Arabinose-5-P isomerase	0.07
<i>lmo2662</i>	D-Ribose-5-P isomerase	4.21
<i>lmo2663</i>	D-Xylulose-5-P reductase (Mn^{2+}) (forms D-arabitol-1-P and/or D-xylitol-5-P)	3.87
<i>lmo2664</i>	D-Xylulose-5-P reductase (Mn^{2+}) (forms D-arabitol-1-P and/or D-xylitol-5-P)	6.32
<i>lmo2664</i>	D-Ribulose-5-P 2-reductase (Mn^{2+}) (forms D-arabitol-5-P)	0.08

^a Metal ions are mentioned when Mg^{2+} was replaced in the assay mixture with either Mn^{2+} or Zn^{2+} .

genase activities of the two enzymes, thus confirming the dependence of the two pentitol-P dehydrogenases on divalent cations. Similarly as observed for *E. avium* ApdH, Mn^{2+} was found to be the preferred cofactor because in the presence of Mg^{2+} the initial activity of the two listerial enzymes was about 10-fold lower (data not shown).

Several PPP Enzymes Are Encoded by the D-Arabitol Operon

The two P-ketopentoses formed by the dehydrogenase Lmo2664, D-ribulose-5-P and D-xylulose-5-P, fuel the

PPP. They are usually interconverted in response to the metabolic need of the cell. Similar to the *E. avium* EIIC, Lmo2665 probably phosphorylates D-arabitol mainly to D-arabitol-1-P, which is oxidized to D-xylulose-5-P. Because the metabolism via the PPP requires one D-ribulose-5-P and two D-xylulose-5-P molecules in order to produce one glyceraldehyde-3-P and two fructose-6-P molecules, a significant part of D-xylulose-5-P formed during growth on D-arabitol needs to be converted to D-ribulose-5-P. Lmo2659 exhibits similarity to D-ribulose-5-P 3-epimerases, which catalyze the interconversion of

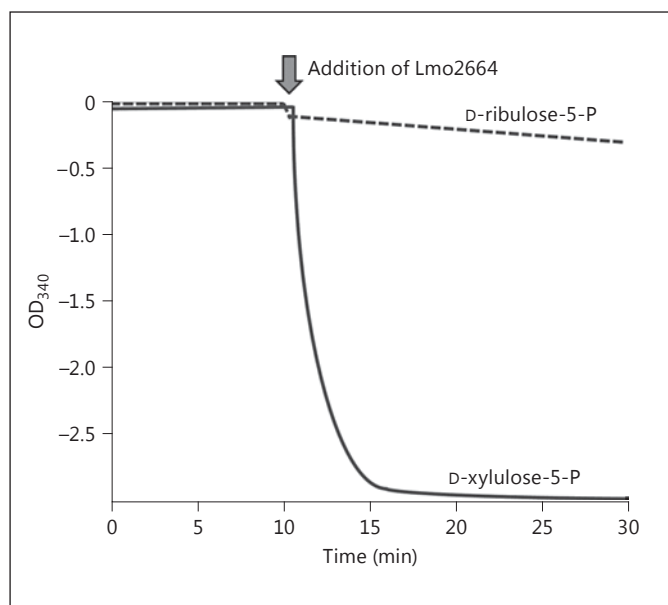

Fig. 3. Spectrophotometric assay of the Lmo2664-catalyzed NADH-dependent reduction of D-ribulose-5-P to D-arabitol-5-P (D-arabitol-5-P 2-dehydrogenase, broken line) and of D-xylulose-5-P to D-arabitol-1-P (D-arabitol-1-P 4-dehydrogenase, solid line). Assay mixtures were prepared as described in Experimental Procedures and preincubated for 12 min at room temperature before the reactions were started by adding Lmo2664 (arrow).

D-xylulose-5-P and D-ribulose-5-P. By carrying out an appropriate enzyme assay, we could indeed confirm that Lmo2659 possesses D-ribulose-5-P 3-epimerase activity (table 1).

To enter the PPP, the ketose D-ribulose-5-P needs to be transformed to the aldose D-ribose-5-P, a metabolite also used for nucleic acid synthesis. The enzyme ribose-5-P isomerase catalyzes the reversible transformation of D-ribose-5-P to D-ribulose-5-P. By using a spectrophotometric assay we could demonstrate that the protein Lmo2662 possesses D-ribose-5-P isomerase activity.

Lmo2661 resembles D-ribulose-5-P 3-epimerases from other organisms. However, we could not confirm the predicted function, but instead found that Lmo2661 exhibits low D-arabinose-5-P isomerase activity. It therefore catalyzes a reaction similar to Lmo2662 by converting the ketose D-ribulose-5-P into the aldose D-arabinose-5-P. In certain bacteria, such as *Agromyces cerinus*, D-arabinose-5-P serves as precursor for the synthesis of poly(arabitol phosphate)-containing cell wall teichoic acid [Shashkov et al., 1995]. A physiological role of D-arabinose-5-P in listeriae has so far not been demonstrated [Cech et al., 2014].

The gene *lmo2660* in the presumed D-arabitol operon encodes probably a transketolase (fig. 1), another key enzyme of the PPP, which converts D-ribose-5-P and xylulose-5-P into glyceraldehyde-3-P and sedoheptulose-7-P. However, deletion of this protein did not prevent growth on D-arabitol as the sole carbon source (data not shown). A likely explanation for this result is the presence of at least two other predicted transketolase-encoding genes in the *L. monocytogenes* genome (*lmo1305* and *lmo0342*), which can probably compensate for the deletion of *lmo2660*.

Growth of *L. monocytogenes* on D-Arabitol Induces Two Operons

The only PPP enzyme lacking in the presumed D-arabitol operon is transaldolase. However, *L. monocytogenes* contains three genes encoding potential transaldolases. One of them, *lmo0500*, is located next to genes encoding the components of another galactitol-type PTS as well as several enzymes strongly resembling the corresponding proteins of the D-arabitol operon (fig. 1b). The strong similarity of the protein sequences and the gene organization prompted us to test whether growth on D-arabitol would induce this presumed second pentitol operon. We therefore carried out qRT-PCR experiments with primers based on the genes *lmo0500*, *lmo0502*, or *lmo2665*, and RNA prepared from *L. monocytogenes* EGD-e cells grown in minimal medium (MM) containing glycerol, glucose, cellobiose, or D-arabitol. Indeed, all three genes were strongly induced when *L. monocytogenes* EGD-e grew on D-arabitol (fig. 4a–c). However, the EIIC PTS component Lmo0508 does not seem to contribute to D-arabitol transport because in contrast to Lmo2665 its deletion had no effect on D-arabitol utilization (fig. 2c).

The genes of both operons were slightly expressed when the cells grew on glycerol (fig. 4a–c). However, growth on glucose or cellobiose almost completely prevented their expression, indicating that both operons are submitted to carbon catabolite repression. Indeed, potential catabolite response elements (*cre*), the target site for the catabolite control protein A (CcpA)/P-Ser-HPr complex [Deutscher et al., 2014b], are located at the beginning of the first gene of the *lmo0498–0508* operon (GTTATTCGTTAGAA) (fig. 1b) and upstream from the first gene of the *lmo2668–2659* region (TGAAAGCGTGTACA) (fig. 1a). In addition, CcpA-independent repression [Deutscher, 2008] might be mediated via the PTS regulation domain (PRD)-containing MtlR-like transcription activators Lmo0501 and Lmo2668 [Deutscher, 2008], which, as shown below, control the expression of the two operons.

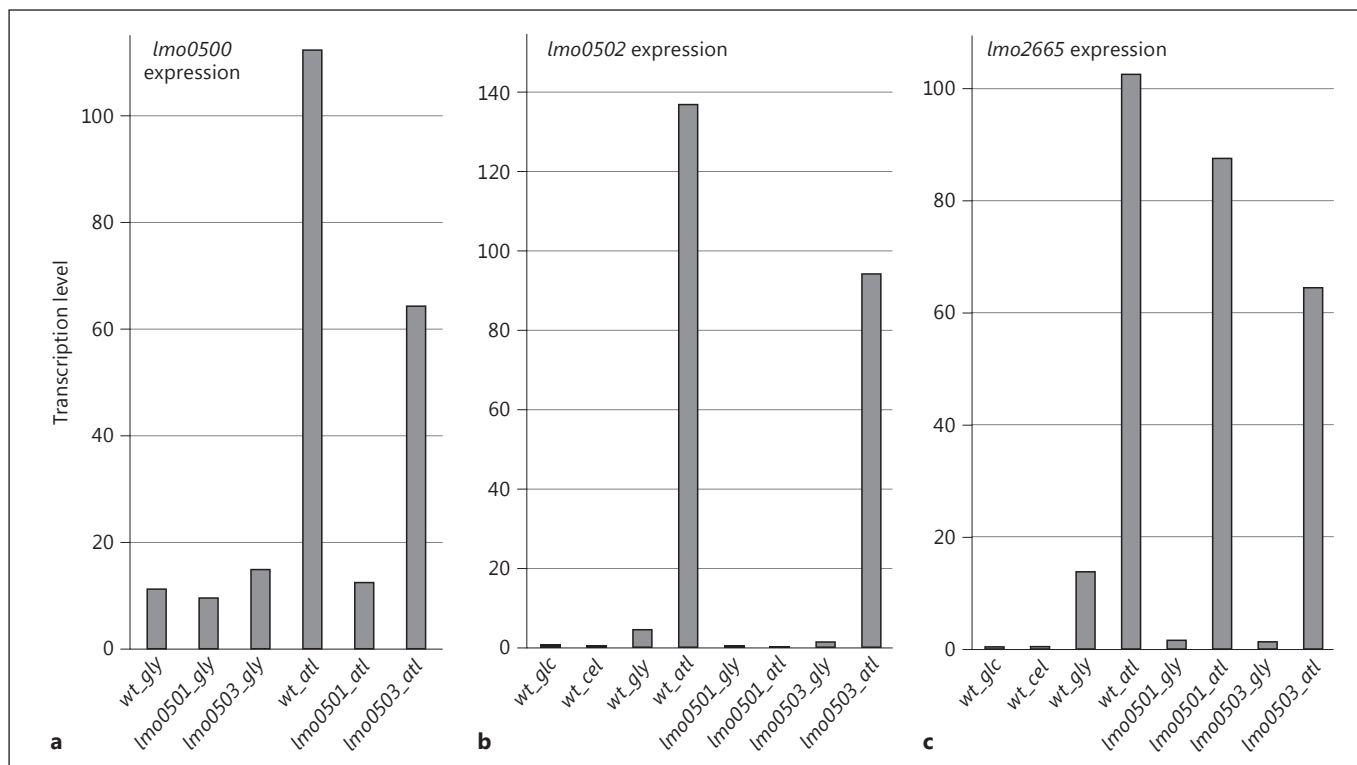

Fig. 4. Expression of D-arabitol-induced genes in AML73 and various mutants derived from it. qRT-PCR experiments were carried out with primer pairs specific for *lmo0500* (a), *lmo0502* (b), or *lmo2665* (c). RNA was prepared from the wild-type strain AML73, the *lmo0501*, or the *lmo0503* mutant. The strains were grown on the indicated carbon source. glc = Glucose; cel = cellobiose; gly =

glycerol; atl = D-arabitol. In all strains, D-arabitol induced the expression of the three tested genes, with the exception of the *lmo0501* mutant, in which the transcription activator of the *lmo0498–0508* operon is deleted and therefore only *lmo2665* was normally induced by D-arabitol.

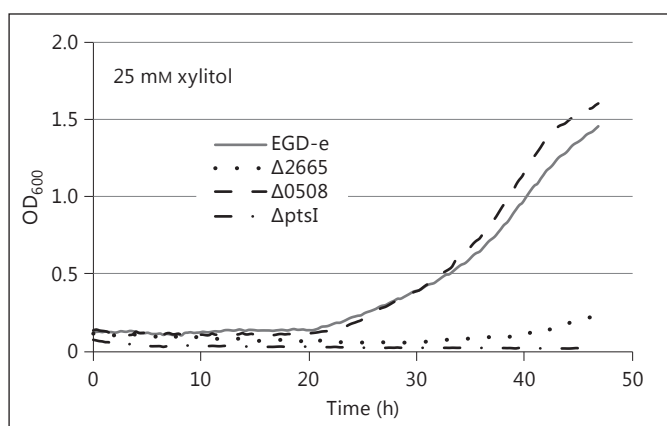
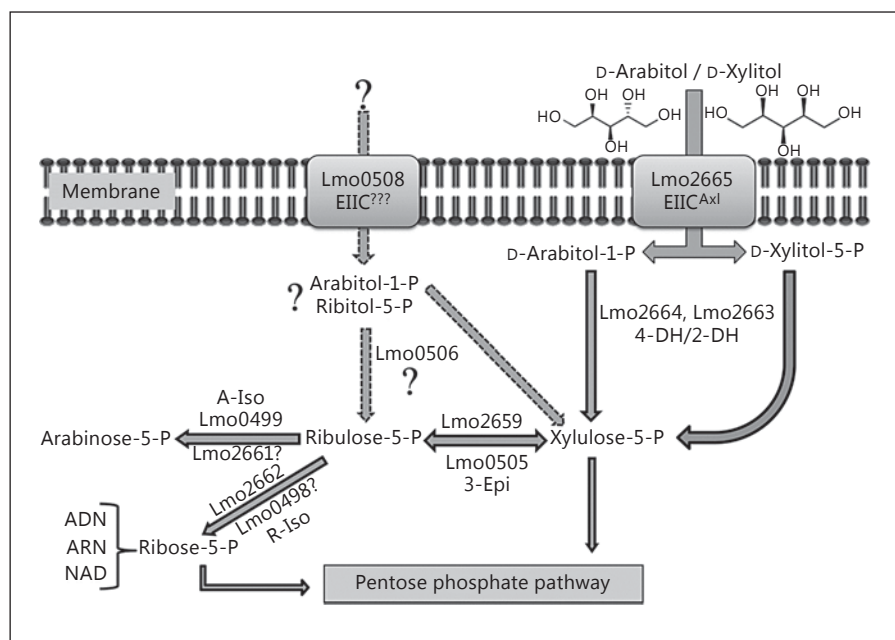

Fig. 5. Growth of *L. monocytogenes* strains on D-xylitol measured with a BioTek microplate reader. The *L. monocytogenes* wild-type strain EGD-e and the $\Delta ptsI$, $\Delta lmo0508$, and $\Delta lmo2665$ mutants derived from it were grown in MM containing 25 mM D-xylitol. While the wild-type strain and the $\Delta lmo0508$ mutant grew on the pentitol, very slow growth was observed for $\Delta lmo2665$ and no growth for the $\Delta ptsI$ mutant.

The D-Arabitol-Specific EIIC Lmo2665 Also Transports D-Xylitol

While carrying out fermentation assays with the gallery API fermentation kit, we noticed that D-xylitol also gave a fermentation signal (data not shown). In addition, the wild-type strain EGD-e was able to grow on MM containing 25 mM D-xylitol as the sole carbon source. The $\Delta ptsI$ mutant had lost this capacity (fig. 5), indicating that D-xylitol is a PTS substrate. We therefore suspected that the EIIC encoded by *lmo0508* might catalyze the transport of D-xylitol. However, the $\Delta lmo0508$ mutant grew normally in MM containing D-xylitol. Instead, we observed that the $\Delta lmo2665$ strain had not only lost the capacity to grow on D-arabitol (fig. 2c), but also grew very poorly on D-xylitol (fig. 5). These results established that the PTS encoded by the genes *lmo2665–2667* transports both D-arabitol and D-xylitol, and we called it PTS^{Axl}. During their uptake via Lmo2665, D-arabitol is probably mainly phosphorylated to D-arabitol-1-P and D-xylitol to

Fig. 6. Proposed model of PTS^{Axl}-catalyzed uptake and phosphorylation of D-arabitol and D-xylitol, and their subsequent catabolism via the PPP in *L. monocytogenes*. The following enzyme activities were determined: A-Iso, arabinose-5-P isomerase; 2-DH, arabitol-5-P 2-dehydrogenase; 4-DH, arabitol-1-P 4-dehydrogenase; 3-Epi, ribulose-5-P 3-epimerase; R-Iso, ribose-5-P isomerase. All these enzymes, except arabinose-5-P isomerase, serve to catabolize phosphorylated D-arabitol and D-xylitol via the PPP. The *lmo0498–0508* region, which is also induced by D-arabitol, encodes several enzymes with activities identical to those of the *lmo2669–2658* operon. However, the substrate of the galactitol type PTS composed of Lmo0503, 0507, and 0508 (EIIC) is not known.



D-xylitol-5-P (fig. 6). This dual substrate specificity might also be the reason why the operon encodes two pentitol-phosphate dehydrogenases Lmo2663 and Lmo2664. Both enzymes use NADH⁺ to reduce xylulose-5-P, but the product could be either D-arabitol-1-P or D-xylitol-5-P. It is therefore possible that one of the two enzymes preferably acts as D-arabitol-1-P dehydrogenase and the other as D-xylitol-5-P dehydrogenase. Unfortunately, we were not able to test this assumption because D-arabitol-1-P and D-xylitol-5-P are not commercially available.

The lmo0498–0508 Operon Also Encodes a Pentitol-P Dehydrogenase and Several PPP Enzymes

In order to get an indication whether the PTS components encoded by the second operon also transport a pentitol, which will subsequently be metabolized via the PPP, we purified Lmo0499, Lmo0505, and Lmo0506. Lmo0499 functions as D-arabinose-5-P isomerase and Lmo0505 as D-ribulose-5-P 3-epimerase (table 1). Lmo0506 exhibits strong sequence similarity to the dehydrogenases Lmo2663 and Lmo2664. It was indeed able to reduce xylulose-5-P, but its activity was significantly lower than that of Lmo2663 and 2664 (table 1). In addition, it preferentially used Zn²⁺ ions instead of Mn²⁺. Similar to Lmo2664, Lmo0506 also reduced D-ribulose-5-P, but this reaction was 3-fold slower than reduction of D-xylulose-5-P. In contrast to Lmo2664, it seems to transform D-ribulose-5-P into D-ribitol-5-P and not D-arabitol-5-P be-

cause Lmo0506 was able to catalyze the reverse reaction, i.e. the oxidation of D-ribitol-5-P. Despite the observed low activities, we tested the possibility that Lmo0508 might transport D-ribitol. However, *L. monocytogenes* was not able to grow on this pentitol as the sole carbon source. Therefore, the substrate of the EIIC PTS component Lmo0508 remains obscure. It could be one of the less abundant L-pentitols, except L-xylitol, which we found cannot be utilized by *L. monocytogenes*. After its uptake, the L-pentitol might be converted to the D-isomer by one of the enzymes of unknown function and subsequently metabolized via the PPP.

Interestingly, *E. avium* also contains two operons encoding very similar galactitol PTSs organized in tandem (fig. 1). Both begin with the gene encoding the PRD-containing transcription activator, which is followed by the three genes for the PTS^{Gat} components and in the first operon by the gene encoding the previously characterized D-arabitol-phosphate dehydrogenase ApdH [Povelainen et al., 2003]. A similar dehydrogenase is encoded by the last gene of the second operon (fig. 1). The substrate of the second PTS is not known.

D-Arabitol Induction of the lmo0498 to lmo0508 Genes Requires the EIIC^{Axl} Components

Both pentitol operons contain a gene coding for an MtlR/LicR-like PRD-containing transcription activator, Lmo0501 and Lmo2668. The operons regulated by this

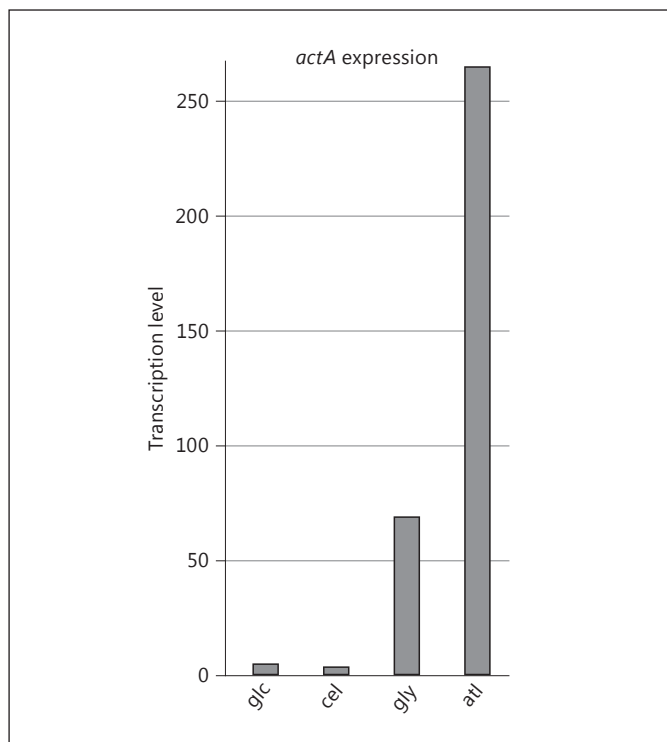

Fig. 7. qRT-PCR experiments with the virulence gene *actA* of strain AML73 grown in liquid MM containing 25 mM of the indicated carbon source. The *actA* gene was poorly expressed in cellobiose- and glucose-grown cells, significantly expressed during growth on glycerol and strongly expressed in D-arabitol-metabolizing cells.

type of transcription activators are usually induced by the uptake and phosphorylation of the corresponding PTS substrate, which prevents phosphorylation of the PRD-containing regulator by the cognate EIIA and EIIB components [Deutscher et al., 2014b]. Although induced by D-arabitol, the EIIC Lmo0508 does not seem to transport this pentitol. Possible explanations are that Lmo2668 activates the expression of both pentitol operons or that Lmo0501 is regulated by the EIIA^{Axl}/EIIB^{Axl} components.

To test the first possibility we interrupted the transcription activator gene *lmo0501* (fig. 1), which did not affect growth on D-arabitol as the sole carbon source (data not shown). qRT-PCR experiments revealed that while *lmo2665* was strongly induced by D-arabitol (fig. 4c), expression of the *lmo0500* gene (fig. 4a) and of the intergenic region between *lmo0500* and *lmo0501* (data not shown) was very low in the *lmo0501* mutant. This result established that only Lmo0501, but not Lmo2668, is able to activate the expression of the *lmo0498* to *lmo0508* genes.

To test the second possibility, we disrupted the EIIA-encoding gene *lmo0503* (fig. 1). Phosphorylation of PRD-containing transcription activators by the corresponding EIIA or EIIB component at the negative regulation site usually leads to their inactivation. Deletion of the EIIA therefore renders the corresponding PRD-containing transcription activator constitutively active [Bouraoui et al., 2013; Deutscher et al., 2014b; Joyet et al., 2010]. qRT-PCR experiments revealed strong expression of the *lmo0500*, *lmo0502*, and *lmo2665* genes in the *lmo0503* mutant during growth on D-arabitol, but not on glycerol (fig. 4a–c). The finding that expression of *lmo0500* and *lmo0502* was not constitutive in the mutant lacking the EIIA and EIIB components Lmo0503 and Lmo0507 suggests that EIIA^{Axl} and EIIB^{Axl} phosphorylate and inactivate not only their proper regulator Lmo2668, but also Lmo0501. A possible explanation for the cross-induction might be that D-arabitol metabolism requires an enzyme encoded by the *lmo0498* to *lmo0508* genes. This could only be a gene upstream from *lmo0501* because disruption of this gene had no effect on D-arabitol utilization. A likely candidate was *lmo0500*, which encodes the PPP enzyme transaldolase. A transaldolase gene is not present in the *axl* operon. However, deletion of *lmo0500* did not affect growth on D-arabitol (data not shown), probably because *L. monocytogenes* contains three other genes encoding potential transaldolases.

Effect of D-Arabitol Utilization on Virulence Gene Expression

Efficiently catabolized carbohydrates transported by the PTS, such as cellobiose, glucose, mannose, and fructose [Stoll and Goebel, 2010], repress the expression of the *L. monocytogenes* virulence genes [Milenbachs et al., 1997; Park and Kroll, 1993]. These carbohydrates are mainly catabolized via the PPP [Eisenreich et al., 2006]. Our results suggest that the PTS substrate D-arabitol is also mainly catabolized via the PPP (fig. 6). We therefore tested whether D-arabitol despite its less efficient utilization compared to glucose (fig. 2) would also inhibit the activity of the virulence gene activator PrfA. Strain AML73 contains the β -D-glucuronidase-encoding *gus* reporter gene fused to the promoter of the PrfA-controlled *L. monocytogenes* virulence gene *hly* [Behari and Youngman, 1998]. It was grown on solid MM containing 100 μ g/ml X-GlcA and various concentrations either of glycerol, glucose, or D-arabitol. AML73 forms white colonies when grown on glucose (within a concentration range of 2.5–50 mM) and blue colonies when grown on the nonrepressing glycerol (online suppl. fig. S2).

Table 2. Bacterial strains and plasmids used in this study

	Genotype and/or property(ies)	Reference or source
<i>Strains</i>		
<i>L. monocytogenes</i>		
AML73	Derivative of strain 10403S; Φ (<i>Phly-gus</i>), serotype 1/2a	[Milenbachs Lukowiak et al., 2004]
EGD-e	<i>L. monocytogenes</i> reference strain, serotype 1/2a	[Glaser et al., 2001]
	EGD-e Δ <i>lmo0500</i>	This work
	EGD-e <i>lmo0501</i>	This work
	EGD-e <i>lmo0503</i>	This work
	EGD-e Δ <i>lmo0508</i>	This work
	EGD-e Δ <i>lmo2660</i>	This work
	EGD-e Δ <i>lmo2665</i>	This work
EM1001	AML73 Δ <i>ptsI</i> (<i>lmo1003</i>)	[Aké et al., 2011]
FA1019	AML73 Δ <i>prfA</i> (<i>lmo0200</i>)	[Aké et al., 2011]
<i>E. coli</i>		
NM522	<i>supE thi-1</i> Δ (<i>lac-proAB</i>) Δ (<i>mcrB-hsdSM</i>) (<i>r_k- m_k-</i>) [F' <i>proAB lacI^qZ</i> Δ GM15]	[Gough and Murray, 1983]
NM522[pREP4(GroES/GroEL)]	<i>supE thi-1</i> Δ (<i>lac-proAB</i>) Δ (<i>mcrB-hsdSM</i>) (<i>r_k- m_k-</i>) [F' <i>proAB lacI^qZ</i> Δ GM15] (<i>kan^R</i>)	[Amrein et al., 1995]
<i>Plasmids</i>		
pMAD	Thermosensitive pE194 replication origin, <i>erm^R</i>	[Arnaud et al., 2004]
pQE30	His-tag expression vector	Qiagen
pREP4(GroES/GroEL)	<i>lacI</i> , <i>kan^R</i> , produces the chaperones GroES/GroEL	[Amrein et al., 1995]

Similar to growth on glycerol, AML73 reproducibly formed blue colonies when utilizing D-arabitol at concentrations ranging from 5 to 25 mM. At 20 and 25 mM D-arabitol, PrfA activity was even stronger than in glycerol-grown cells. Repression of the reporter gene was only observed when the pentitol was used at 50 mM. No expression of the reporter gene occurred in an AML73-derived *prfA* mutant grown on D-arabitol (online suppl. fig. S2).

Similar results were obtained when qRT-PCR experiments were carried out with RNA isolated from cells grown on 25 mM glucose, cellobiose, glycerol, or D-arabitol, and primers specific for the virulence gene *actA* (fig. 7). Almost no *actA* expression was observed when AML73 was grown on cellobiose or glucose. Glycerol-grown cells exhibited significant *actA* expression, which, however, was about 4-times higher in D-arabitol-grown AML73. D-Arabitol at concentrations up to 25 mM apparently does not repress virulence gene expression, although it is probably catabolized via the PPP. Inhibition of *L. monocytogenes* virulence gene expression requires very high concentrations of D-arabitol. This resembles the behavior of a mutant deleted for the main glucose transporter ManL, which takes up the hexose via low-efficiency PTSs. In this mutant glucose, up to 20 mM did not re-

press virulence gene expression [Aké et al., 2011]. It therefore seems that only efficient PTS-mediated transport of a carbon source can elicit catabolite repression of *L. monocytogenes* virulence genes.

Experimental Procedures

Bacterial Strains, Plasmids, and Growth Conditions

The *L. monocytogenes* strains and plasmids used in this study are listed in table 2. Growth studies were carried out at 37°C with shaking in MM [Premaratne et al., 1991] supplemented with the indicated carbon source in a BioTek microplate reader. Each strain was grown in duplicate and the absorption at 600 nm (A_{600}) was measured every 10 min. For qRT-PCR experiments, *L. monocytogenes* cells were grown at 37°C with shaking in MM supplemented with the indicated carbon source (25 mM). For the construction of deletion or disruption mutants, *L. monocytogenes* cells were grown on solid BHI medium at 30 or 42°C. To screen *L. monocytogenes* clones during mutant construction, 100 µg/ml 5-bromo-4-chloro-3-indolyl β-D-galactopyranoside (X-Gal) was added to solid media. Erythromycin was used at a concentration of 5 µg/ml for the selection of *L. monocytogenes* integrants. For fermentation assays we used the gallery API fermentation kit of bioMérieux (Craponne, France). *Escherichia coli* cells were grown in Luria-Bertani medium at 37°C with shaking. The concentration of antibiotics used for the selection of *E. coli* transformants was 100 µg/ml for ampicillin and 30 µg/ml for kanamycin.

The plasmid pMAD (table 2) contains a thermosensitive pE194 replication origin [Villafane et al., 1987] and produces a thermostable β -D-galactosidase from *Geobacillus stearothermophilus* [Arnaud et al., 2004]. Plasmid pQE30 (Qiagen) was used for the synthesis of His-tagged proteins in *E. coli* strain NM522 or NM522 containing the plasmid pREP4-GroES/EL [Amrein et al., 1995].

Construction of *L. monocytogenes* Deletion Mutants

To construct EGD-e-derived deletion mutants (table 2), two DNA fragments located upstream and downstream from the respective gene were amplified by PCR using genomic DNA as the template and the appropriate primer pairs (online suppl. table S1). In a second PCR, the two obtained amplicons were used as the template together with the two distal primers, which allowed fusion of the two DNA fragments. The resulting PCR products were digested with the appropriate restriction enzymes and cloned into the vector pMAD (table 2). For the construction of the deletion mutants $\Delta lmo2665$, $\Delta lmo2660$, $\Delta lmo0500$, and $\Delta lmo0508$, we followed a previously described protocol [Aké et al., 2011].

Construction of *L. monocytogenes* Gene Disruption Mutants

For the insertional inactivation of the *lmo0501* and *lmo0503* genes by single homologous recombination, internal fragments of about 350 bp of the corresponding genes were amplified by PCR using appropriate primers (online suppl. table S1) and the PCR products were digested and cloned into pMAD. Disruption of the target genes in EGD-e was carried out as previously described [Monniot et al., 2012].

Cloning of D-Arabitol-Related Genes into His Tag Expression Vectors

The two pentitol operons of *L. monocytogenes* encode together 13 catabolic enzymes (fig. 1). Nine of them were amplified by PCR using chromosomal DNA of strain EGD-e as the template and an appropriate primer pair (online suppl. table S1). The resulting nine PCR products were cut with restriction enzymes and cloned into the His tag expression vector pQE30 (Qiagen). The correct sequence of each gene was confirmed by DNA sequencing. Eight of the resulting plasmids carrying the different amplified genes were used to transform *E. coli* strain NM522. The protein encoded by the *lmo2663* gene could not be obtained in soluble form because it formed inclusion bodies when produced in strain NM522. The *lmo2663*-containing plasmid was therefore used to transform the *E. coli* strain NM522[pREP4-GroES/EL], which carries the plasmid pREP4 (Qiagen) containing the genes for the chaperone GroES/GroEL [Amrein et al., 1995]. Overproduction in this strain rendered Lmo2663 soluble and allowed its purification. We failed to purify Lmo0498, which remains insoluble even when produced in NM522[pREP4GroES/EL].

Synthesis and Purification of His-Tagged Enzymes

For the purification of His-tagged proteins from *E. coli* strain NM522 carrying plasmid pQE30 containing the different *L. monocytogenes* genes, we followed a previously described protocol [Monniot et al., 2012]. The strains were grown at 37°C to an optical density at 600 nm (OD_{600}) of 0.5–0.6 before 1 mM isopropyl- β -D-thiogalactopyranoside (IPTG) was added. Growth was continued for 3 h before the cells were harvested by centrifugation. For the purification of Lmo2663, strain NM522[pREP4-GroES/EL]

carrying the pQE30-derived plasmid with the *lmo2663* gene was grown at 37°C to an OD_{600} of 0.5–0.6 before the temperature of the growth medium was lowered to 30°C and 0.1 mM IPTG was added. Growth continued at 30°C overnight before the cells were harvested by centrifugation. Preparation of crude extracts and protein purification by ion chelate affinity chromatography were carried out as previously described [Monniot et al., 2012]. Protein concentrations were determined with a dye binding assay [Bradford, 1976]. The purity of the eight isolated proteins was determined by electrophoresis on 0.1% SDS/12.5% polyacrylamide gels (online suppl. fig. S1). His-tagged ribitol-5-P 2-dehydrogenase from *L. casei* used for several spectrophotometric assays was purified as previously described [Bourand et al., 2013].

Spectrophotometric Enzyme Activity Assays

In order to measure the activities of the purified enzymes, we set up a series of spectrophotometric assays. Because the P-pentitols are not commercially available, we measured the presumed reductase activities of Lmo0506, Lmo2663, and Lmo2664 (EC 1.1.1.137; EC 1.1.1.301a; EC 1.1.1.301b) by following the transformation of D-xylulose-5-P into either D-xylitol-5-P or D-arabitol-1-P, and of D-ribulose-5-P into either D-ribitol-5-P or D-arabitol-5-P. We used a 0.5-ml assay mixture containing 50 mM Tris-HCl (pH 7.4), 5 mM $MgCl_2$, 0.25 mM NADH (Sigma-Aldrich, Saint Quentin Fallavier, France), and 0.5 mM D-xylulose-5-P or 0.5 mM D-ribulose-5-P (Sigma-Aldrich). After preincubation for 10 min, the reaction was started by adding 20 μ g of one of the three pentitol-P dehydrogenases (Lmo0506, Lmo2663, and Lmo2664). The disappearance of NADH was followed by measuring the OD at 340 nm with an UVIKON 9X3W double-beam spectrophotometer (Kontron Bio-Tek) using the 'Aurorate' program. In order to confirm the dependence of the three pentitol-P dehydrogenases on divalent cations, EDTA (ethylenediaminetetraacetic acid) was added at a final concentration of 10 mM to the assay mixture, which was preincubated for 10 min before the reaction was started. Owing to the ambiguity about the product formed during ribulose-5-P reduction, we synthesized D-ribitol-5-P by reducing D-ribose-5-P with $NaBH_4$ as previously described [London and Hausman, 1982] and used it as substrate for Lmo2664 and Lmo0506. The assay mixture contained 50 mM Tris-HCl (pH 7.4), 5 mM $MnCl_2$ or $MgCl_2$, 0.25 mM NAD (Sigma-Aldrich), and 0.5 mM D-ribitol-5-P.

Lmo2659 and Lmo0505 transform D-xylulose-5-P (Sigma-Aldrich) into D-ribulose-5-P, and thus function as D-ribulose-5-P 3-epimerases (EC 5.1.3.1). The reaction was coupled to the NADH-requiring reduction of D-ribulose-5-P to D-ribitol-5-P by ribitol-5-P 2-dehydrogenase from *L. casei* [Bourand et al., 2013]. The 0.5-ml assay mixture contained 50 mM Tris-HCl (pH 7.4), 5 mM $MgCl_2$, 0.5 mM NADH, 0.5 mM D-ribose-5-P, and 18 μ g D-ribitol-5-P 2-dehydrogenase (1.3 enzyme units). The reaction was started by adding either Lmo2659 (95 μ g) or Lmo0505 (85 μ g), and the disappearance of NADH was monitored by measuring the absorption at 340 nm.

The assay for the presumed D-ribose-5-P isomerase Lmo2662 (EC 5.3.1.6), which transforms D-ribose-5-P into D-ribulose-5-P, was also coupled to the reduction of D-ribulose-5-P to D-ribitol-5-P. The 0.5-ml assay mixture contained 50 mM Tris-HCl (pH 7.4), 5 mM $MgCl_2$, 0.5 mM NADH, 0.5 mM D-ribose-5-P, and 18 μ g (1.3 U) D-ribitol-5-P 2-dehydrogenase from *L. casei*. The reaction was started by adding 22 μ g of purified Lmo2662 to the assay mixture, and the disappearance of NADH was followed at 340 nm.

A very similar assay was used to confirm the D-arabinose-5-P isomerase (EC 5.3.1.13) activity of Lmo0499 and Lmo2661 by starting from D-arabinose-5-P (Sigma-Aldrich), which these two enzymes transform into D-ribulose-5-P. The 0.5-ml assay mixture contained 50 mM Tris-HCl (pH 7.4), 5 mM MgCl₂, 0.5 mM NADH, 0.5 mM D-arabinose-5-P, and 18 µg (1.3 U) D-ribitol-5-P 2-dehydrogenase. The reaction was started by adding one of the two presumed D-arabinose-5-P isomerases Lmo0499 (20 µg) or Lmo2661 (55 µg), and the disappearance of NADH was monitored by measuring the absorption at 340 nm.

β-D-Glucuronidase Assays

To measure the repressing effect of carbon sources on PrfA-controlled virulence gene expression, we used *L. monocytogenes* strain AML73. It contains the promoter of the *hly* gene, which encodes a *L. monocytogenes* virulence factor, fused to the *β*-D-glucuronidase-encoding *gus* reporter gene [Behari and Youngman, 1998]. To detect *β*-D-glucuronidase activity on solid media in AML73 and mutants derived from it, cells were grown in 10 ml BHI medium to a stationary phase and washed twice with 10 ml MM before they were resuspended in 10 ml MM. Aliquots of 5 µl were spotted onto buffered solid MM (1% agar) containing 100 µg/ml 5-bromo-4-chloro-3-indolyl *β*-D-glucuronide (X-GlcA) and different concentrations (2.5, 5, 10, 20, 25, and 50 mM) of either glucose, glycerol, or D-arabitol. The plates were kept for up to 72 h at 37°C in order to allow the hydrolysis of X-GlcA by *β*-D-glucuronidase, which leads to the formation of blue color [Milenbachs Lukowiak et al., 2004].

RNA Isolation and qRT-PCR

In order to measure the expression of the two D-arabitol-induced operons, the *L. monocytogenes* wild-type strain as well as the *lmo0501* (encodes a PRD-containing regulator) and *lmo0503* mutants (encodes an EIIA component) were grown to an exponential phase in MOPS-buffered MM (pH 7.0) supplemented with 25 mM

glycerol, cellobiose, glucose, or D-arabitol. Identical growth media were used for qRT-PCR experiments aimed to determine the effect of various carbon sources (25 mM glucose, glycerol, cellobiose, or D-arabitol) on the expression of the virulence gene *actA*. Cells from 30 ml cultures were collected by centrifugation and RNA was extracted using the RNeasy Mini Kit (Qiagen) according to the manufacturer's instructions. Residual DNA was removed using the Turbo DNA-free kit (Ambion). The quality of the RNA preparation was tested with an Agilent Bioanalyzer before RT reactions were performed using random hexamers (GE Healthcare) and the Super-Script III Reverse Transcriptase (Invitrogen) according to the manufacturer's recommendations. qRT-PCR experiments were carried out with a LightCycler (Roche). We used primers specific either for *lmo0500*, the intergenic region between *lmo0500* and *lmo0501*, *lmo0502*, *lmo2665*, or the PrfA-controlled *actA* virulence gene. We followed the protocol of the LightCycler Faststart DNA Master SYBR Green I Kit (Roche). Data were processed with the Roche Molecular Biochemicals LightCycler Software. In order to normalize the transcript levels, the constitutively expressed *rpoB* gene was used as a reference [Milohanic et al., 2003]. Statistical analyses of the data were carried out with the Wilcoxon-Mann-Whitney test.

Acknowledgements

We thank Alexa Bourand for providing us with purified D-ribitol-5-P 2-dehydrogenase from *L. casei*, and Nancy Freitag for sending us strain AML73. This research was supported by the Agence National de la Recherche, grant ANR-09-BLANC-0273-01 and the 'Initiative d'Excellence' program from the French government (grant DYNAMO, ANR-11-LABX-0011). T.N.C. received a fellowship from Campus France and A.M. from the Algerian government.

References

- Aké FM, Joyet P, Deutscher J, Milohanic E: Mutational analysis of glucose transport regulation and glucose-mediated virulence gene repression in *Listeria monocytogenes*. *Mol Microbiol* 2011;81:274–293.
- Alpert CA, Frank R, Stüber K, Deutscher J, Hengstenberg W: Phosphoenolpyruvate-dependent protein kinase enzyme I of *Streptococcus faecalis*. Purification and properties of the enzyme and characterization of its active center. *Biochemistry* 1985;24:959–964.
- Amrein KE, Takacs B, Stieger M, Molnos J, Flint NA, Burn P: Purification and characterization of recombinant human p50csk protein-tyrosine kinase from an *Escherichia coli* expression system overproducing the bacterial chaperones GroES and GroEL. *Proc Natl Acad Sci USA* 1995;92:1048–1052.
- Arnaud M, Chastanet A, Débarbouillé M: New vector for efficient allelic replacement in naturally nontransformable, low-GC-content, gram-positive bacteria. *Appl Environ Microbiol* 2004;70:6887–6891.
- Barabote RD, Saier MH Jr: Comparative genomic analyses of the bacterial phosphotransferase system. *Microbiol Mol Biol Rev* 2005;69:608–634.
- Behari J, Youngman P: Regulation of *hly* expression in *Listeria monocytogenes* by carbon sources and pH occurs through separate mechanisms mediated by PrfA. *Infect Immun* 1998;66:3635–3642.
- Bourand A, Yebra MJ, Boël G, Mazé A, Deutscher J: Utilization of D-ribitol by *Lactobacillus casei* BL23 requires a mannose-type phosphotransferase system and three catabolic enzymes. *J Bacteriol* 2013;195:2652–2661.
- Bouraoui H, Ventroux M, Noirot-Gros M-F, Deutscher J, Joyet P: Membrane sequestration by the EIIB domain of the mannitol permease MtlA activates the *Bacillus subtilis* *mtl* operon regulator MtlR. *Mol Microbiol* 2013;87:789–801.
- Bradford MM: A rapid and sensitive method for the quantitation of microgram quantities of protein utilizing the principle of protein-dye binding. *Anal Biochem* 1976;72:248–254.
- Brünker P, Altenbuchner J, Mattes R: Structure and function of the genes involved in mannitol, arabitol and glucitol utilization from *Pseudomonas fluorescens* DSM50106. *Gene* 1998;206:117–126.
- Brünker P, Kulbe KD, Altenbuchner J, Mattes R: Cloning, nucleotide sequence and expression of a mannitol dehydrogenase gene from *Pseudomonas fluorescens* DSM 50106 in *Escherichia coli*. *Biochim Biophys Acta* 1997;1351:157–167.
- Cao Y, Jin X, Levin EJ, Huang H, Zong Y, Quick M, Weng J, Pan Y, Love J, Punta M, Rost B, Hendrickson WA, Javitch JA, Rajashankar KR, Zhou M: Crystal structure of a phosphorylation-coupled saccharide transporter. *Nature* 2011;473:50–54.

- Cech DL, Wang PF, Holt MC, Assimon VA, Schaub JM, Holler TP, Woodard RW: A novel glucose 6-phosphate isomerase from *Listeria monocytogenes*. *Protein J* 2014;33:447–456.
- Deutscher J: The mechanisms of carbon catabolite repression in bacteria. *Curr Opin Microbiol* 2008;11:87–93.
- Deutscher J, Aké FM, Derkaoui M, Zébré AC, Cao TN, Bouraoui H, Kentache T, Mokhtari A, Milohanic E, Joyet P: The bacterial phosphoenolpyruvate:carbohydrate phosphotransferase system: regulation by protein phosphorylation and phosphorylation-dependent protein-protein interactions. *Microbiol Mol Biol Rev* 2014b;78:231–256.
- Deutscher J, Aké FMD, Zébré AC, Cao TN, Kentache T, Monniot C, Ma Pham QM, Mokhtari A, Joyet P, Milohanic E: Carbohydrate utilization by *Listeria monocytogenes* and its influence on virulence gene expression; in Hambrick EC (ed): *Listeria monocytogenes: Food Sources, Prevalence and Management Strategies*. New York, Nova Science Publishers, 2014a, pp 49–76.
- Deutscher J, Beyreuther K, Sobek HM, Stüber K, Hengstenberg W: Phosphoenolpyruvate-dependent phosphotransferase system of *Staphylococcus aureus*: factor III^{Lac}, a trimeric phospho-carrier protein that also acts as a phase transfer catalyst. *Biochemistry* 1982;21:4867–4873.
- Eisenreich W, Slaghuis J, Laupitz R, Bussemer J, Stritzker J, Schwarz C, Schwarz R, Dandekar T, Goebel W, Bacher A: ¹³C isotopologue perturbation studies of *Listeria monocytogenes* carbon metabolism and its modulation by the virulence regulator PrfA. *Proc Natl Acad Sci USA* 2006;103:2040–2045.
- Glaser P, Frangeul L, Buchrieser C, Rusniok C, Amend A, Baquero F, Berche P, Bloecker H, Brandt P, Chakraborty T, Charbit A, Chetouani F, Couve E, de Daruvar A, Dehoux P, Domann E, Dominguez-Bernal G, Duchaud E, Durant L, Dussurget O, Entian KD, Fsihi H, Garcia-del Portillo F, Garrido P, Gautier L, Goebel W, Gomez-Lopez N, Hain T, Hauf J, Jackson D, Jones LM, Kaerst U, Kreft J, Kuhn M, Kunst F, Kurapkat G, Madueno E, Maitournam A, Vicente JM, Ng E, Nedjari H, Nordsiek G, Novella S, de Pablos B, Perez-Diaz JC, Purcell R, Rammel B, Rose M, Schlueter T, Simoes N, Tierrez A, Vazquez-Boland JA, Voss H, Wehland J, Cossart P: Comparative genomics of *Listeria* species. *Science* 2001;294:849–852.
- Gough JA, Murray NE: Sequence diversity among related genes for recognition of specific targets in DNA molecules. *J Mol Biol* 1983;166:1–19.
- Hausman SZ, London J: Purification and characterization of ribitol-5-phosphate and xylitol-5-phosphate dehydrogenases from strains of *Lactobacillus casei*. *J Bacteriol* 1987;169:1651–1655.
- Herro R, Poncet S, Cossart P, Buchrieser C, Gouin E, Glaser P, Deutscher J: How seryl-phosphorylated HPr inhibits PrfA, a transcription activator of *Listeria monocytogenes* virulence genes. *J Mol Microbiol Biotechnol* 2005;9:224–234.
- Heuel H, Turgut S, Schmid K, Lengeler JW: Substrate recognition domains as revealed by active hybrids between the D-arabinitol and ribitol transporters from *Klebsiella pneumoniae*. *J Bacteriol* 1997;179:6014–6019.
- Joyet P, Derkaoui M, Poncet S, Deutscher J: Control of *Bacillus subtilis* *mtl* operon expression by complex phosphorylation-dependent regulation of the transcriptional activator MtlR. *Mol Microbiol* 2010;76:1279–1294.
- Laslo T, von Zalusowski P, Gabris C, Lodd E, Rückert C, Dangel P, Kalinowski J, Auchter M, Seibold G, Eikmanns BJ: Arabitol metabolism of *Corynebacterium glutamicum* and its regulation by AtIR. *J Bacteriol* 2012;194:941–955.
- London J, Hausman S: Xylitol-mediated transient inhibition of ribitol utilization by *Lactobacillus casei*. *J Bacteriol* 1982;150:657–661.
- London J, Hausman SZ: Purification and characterization of the III^{XII} phospho-carrier protein of the phosphoenolpyruvate-dependent xylitol:phosphotransferase found in *Lactobacillus casei* C183. *J Bacteriol* 1983;156:611–619.
- Mertins S, Joseph B, Goetz M, Ecke R, Seidel G, Sprehe M, Hillen W, Goebel W, Müller-Altröck S: Interference of components of the phosphoenolpyruvate phosphotransferase system with the central virulence gene regulator PrfA of *Listeria monocytogenes*. *J Bacteriol* 2007;189:473–490.
- Milenbachs AA, Brown DP, Moors M, Youngman P: Carbon-source regulation of virulence gene expression in *Listeria monocytogenes*. *Mol Microbiol* 1997;23:1075–1085.
- Milenbachs Lukowiak A, Mueller KJ, Freitag NE, Youngman P: Deregulation of *Listeria monocytogenes* virulence gene expression by two distinct and semi-independent pathways. *Microbiology* 2004;150:321–333.
- Milohanic E, Glaser P, Coppée JY, Frangeul L, Vega Y, Vázquez-Boland JA, Kunst F, Cossart P, Buchrieser C: Transcriptome analysis of *Listeria monocytogenes* identifies three groups of genes differently regulated by PrfA. *Mol Microbiol* 2003;47:1613–1625.
- Monniot C, Zébré AC, Aké FMD, Deutscher J, Milohanic E: Novel histerial glycerol dehydrogenase- and phosphoenolpyruvate-dependent dihydroxyacetone kinase system connected to the pentose phosphate pathway. *J Bacteriol* 2012;194:4972–4982.
- Park SF, Kroll RG: Expression of listeriolysin and phosphatidylinositol-specific phospholipase C is repressed by the plant-derived molecule cellobiose in *Listeria monocytogenes*. *Mol Microbiol* 1993;8:653–661.
- Povelainen M, Eneyskaya EV, Kulminkaya AA, Ivanen DR, Kalkkinen N, Neustroev KN, Miasnikov AN: Biochemical and genetic characterization of a novel enzyme of pentitol metabolism: D-arabitol-phosphate dehydrogenase. *Biochem J* 2003;371:191–197.
- Premaratne RJ, Lin WJ, Johnson EA: Development of an improved chemically defined minimal medium for *Listeria monocytogenes*. *Appl Environ Microbiol* 1991;57:3046–3048.
- Saklani-Jusforgues H, Fontan E, Goossens PL: Characterisation of a *Listeria monocytogenes* mutant deficient in D-arabitol fermentation. *Res Microbiol* 2001;152:175–177.
- Scortti M, Monzó HJ, Lacharme-Lora L, Lewis DA, Vázquez-Boland JA: The PrfA virulence regulon. *Microbes Infect* 2007;9:1196–1207.
- Shashkov AS, Streshinskaya GM, Gnilozub VA, Evtushenko LI, Naumova IB: Poly(arabitol phosphate) teichoic acid in the cell wall of *Agromyces cerinus* subsp. *cerinus* VKM Ac-1340T. *FEBS Lett* 1995;37:163–166.
- Stoll R, Goebel W: The major PEP-phosphotransferase systems (PTs) for glucose, mannose and cellobiose of *Listeria monocytogenes*, and their significance for extra- and intracellular growth. *Microbiology* 2010;156:1069–1083.
- Villafane R, Bechhofer DH, Narayanan CS, Dubnau D: Replication control genes of plasmid pE194. *J Bacteriol* 1987;169:4822–4829.
- Volpon L, Young CR, Matte A, Gehring K: NMR structure of the enzyme GatB of the galactitol-specific phosphoenolpyruvate-dependent phosphotransferase system and its interaction with GatA. *Protein Sci* 2006;15:2435–2441.
- Zébré AC, Aké FM, Ventroux M, Koffi-Nevry R, Noirot-Gros MF, Deutscher J, Milohanic E: Interaction with enzyme IIB^{Mpo} (EIIB^{Mpo}) and phosphorylation by P~EIIB^{Mpo} exert antagonistic effects on the transcriptional activator ManR of *Listeria monocytogenes*. *J Bacteriol* 2015;197:1559–1572.