



HAL
open science

Impact of cerium and lanthanum on the photo-darkening and photo-bleaching mechanisms in thulium-doped fibre

Jean-François Lupi, Manuel Vermillac, Wilfried Blanc, Franck Mady, Mourad Benabdesselam, Bernard Dussardier, Daniel R. Neuville

► To cite this version:

Jean-François Lupi, Manuel Vermillac, Wilfried Blanc, Franck Mady, Mourad Benabdesselam, et al.. Impact of cerium and lanthanum on the photo-darkening and photo-bleaching mechanisms in thulium-doped fibre. *Optical Materials*, 2017, 72, pp.106-114. 10.1016/j.optmat.2017.04.066 . hal-01598970

HAL Id: hal-01598970

<https://hal.science/hal-01598970v1>

Submitted on 12 Nov 2017

HAL is a multi-disciplinary open access archive for the deposit and dissemination of scientific research documents, whether they are published or not. The documents may come from teaching and research institutions in France or abroad, or from public or private research centers.

L'archive ouverte pluridisciplinaire **HAL**, est destinée au dépôt et à la diffusion de documents scientifiques de niveau recherche, publiés ou non, émanant des établissements d'enseignement et de recherche français ou étrangers, des laboratoires publics ou privés.

Impact of cerium and lanthanum on the photo-darkening and photo-bleaching mechanisms in thulium-doped fibre

Jean-François Lupi^a, Manuel Vermillac^a, Wilfried Blanc^{a,*}, Franck Mady^a, Mourad Benabdesselam^a, Bernard Dussardier^a, Daniel R. Neuville^b

^a Université Côte d'Azur, CNRS, INΦNI, UMR7010, Parc Valrose, 06108 Nice, Cedex 2, France

^b Équipe des Géomatériaux, IGP, COMUE Sorbonne Paris-Cité, CNRS UMR 7154, 1 Rue Jussieu, 75005 Paris, France

A B S T R A C T

Photo-darkening prevents developing of new applications of rare-earth doped silica fibre lasers or amplifiers operating at wavelengths shorter than $1\ \mu\text{m}$ or at any wavelength at high power. The photo-darkening is characterized by a decrease of the laser intensity during amplification. In this article, we are interested in *Tm*-doped fibres. This ion offers many potential optical transitions spanning from 0.45 to $1.9\ \mu\text{m}$. Several interesting transitions can be excited via up-conversion, using one pump around $1\ \mu\text{m}$. However, this scheme induces a particularly fast and intense photo-darkening, enough to prevent amplification in the short wavelengths region (0.45 – $0.9\ \mu\text{m}$). To mitigate this effect, we co-dope the fibres with cerium or lanthanum ions. By characterizing the steady state values of photo-darkening and its characteristic times, we demonstrate the beneficial role of *Ce* and *La* on the bleaching mechanisms.

Keywords:
Optical fibre
Thulium
Photo-darkening
Silica

1. Introduction

Silica as a glass host for rare-earth (RE) doped fibre lasers and amplifiers offers the best performances in terms of efficiency, power, reliability and cost effectiveness. It is indeed chemically stable, mechanically robust and its optical transparency is high in the visible and the near-infra-red (NIR) range up to $2\ \mu\text{m}$. Then, silica is the main glass used, for example, in high power fibre lasers [1]. In the case of *Yb*-doped fibre, this technology reaches kilowatt level in single mode and continuous wave regime. Presently, one of the main issues related to the output power is related to the photo-darkening mechanism. It is characterized by the presence of a broad absorption band in the visible and NIR. It causes the decreasing of the laser power versus time. This induced loss has a significant impact on the threshold and the laser slope efficiency [2]. In addition, photo-darkening is suspected also to trigger mode instability, leading to a degradation of the *M* factor of these lasers [3–6].

For the development of fibre lasers at wavelengths shorter than $1\ \mu\text{m}$, thulium (Tm^{3+}) is particularly interesting because it offers many potential optical transitions spanning from 0.45 to $1.9\ \mu\text{m}$.

Except for the conventional pumping scheme at $0.79\ \mu\text{m}$ which provides efficient amplification around $1.9\ \mu\text{m}$ through a down-conversion energy transfer process [7], none of the other transitions are exploited in silica. An interesting up-conversion pumping scheme using a pump source at $1.07\ \mu\text{m}$ provides up to seven laser emissions (spanning from 0.45 to $1.9\ \mu\text{m}$) that were implemented in ZBLAN fibres [8]. If one applies this scheme to a *Tm*-doped silica fibre, two phenomena will hamper amplification: fluorescence quenching by non-radiative decay and transparency degradation by photo-darkening [9,10]. The high phonon-energy of silica glass (as compared with fluorides) induces fast non-radiative decays from most energy levels of thulium, causing a strong reduction of their effective lifetimes and hence the reachable population inversion, even under high pumping. In *Tm*-doped silica, the non-radiative decay from the 3H_4 excited level may be mitigated by high *Al* co-doping, promoting the amplification of the $0.8\ \mu\text{m}$ and $1.47\ \mu\text{m}$ emission bands as well as up-conversion to higher energy levels (see Fig. 1 right) [9,11,12]. Because the sought applications necessitate high concentrations of aluminium and thulium, strong photo-darkening is observed [10,13]. Besides, pumping of RE-doped optical fibres may cause the degradation of the transparency of both silica and fluoride glasses, especially when they are heavily doped with RE ions [10,13–17]. In the case of thulium-doped silica fibre pumped at $1.07\ \mu\text{m}$, photo-darkening (or photo-induced

* Corresponding author.

E-mail address: wilfried.blanc@unice.fr (W. Blanc).

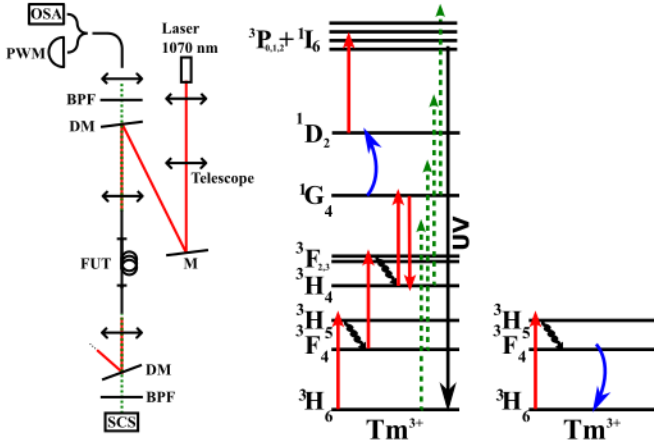

Fig. 1. Left: Experimental setup for PIA measurement. M: dielectric mirror, FUT: fiber under test, BPF: band pass filter, DM: dichroic mirror, OSA: optical spectrum analyser, SCS: supercontinuum source, PWM: power meter. Right: Energy level diagram of Tm^{3+} ; red: pump induced transitions, blue: energy transfer, green: $0.55 \mu m$ probe. (For interpretation of the references to colour in this figure legend, the reader is referred to the web version of this article.)

attenuation, PIA) is particularly fast and intense, enough to prevent amplification in the extended-visible region ($0.45\text{--}0.9 \mu m$) [10]. The beneficial role of co-doping with cerium or lanthanum ions to mitigate the steady states of photo-darkening has been reported previously [18]. The aim of this article is to study both the steady state of photo-darkening and its characteristic time to discuss the role of *Ce* and *La* on the generation and bleaching mechanisms.

2. Samples preparation

Preforms were fabricated by the conventional Modified Chemical Vapor Deposition (MCVD) technique [19] and the so-called solution doping technique [20] was applied to incorporate aluminium (*Al*), thulium (*Tm*), cerium (*Ce*) and lanthanum (*La*) ions. To fabricate a preform, a porous silica layer was deposited inside substrate silica tube. After soaking of the layer with ionic solutions of chloride salts, the solvent was dried and the core layer was sintered down to a dense glass layer. Then the tube was collapsed into a solid rod, referred to as preform, at an elevated temperature higher than $1800^\circ C$. Preforms were stretched into $125 \mu m$ fibres using a drawing tower at temperatures higher than $2000^\circ C$ under normal conditions. Three series of samples were prepared with various concentrations of thulium, lanthanum and cerium ions. The concentrations of *Al*, *Tm*, *Ce* and *La* were measured by EPMA (Electron Probe Micro-Analysis) in the fibres. All the concentrations are given in atomic ppm and reported in Table 1. In all samples, the concentration of aluminum remained almost constant, typically around 8000 ppm . In the *Tm* series, the concentration of thulium spans from 0 to 600 ppm . In the *La* series, the concentration of lanthanum varies from 350 to 7000 ppm whereas the concentrations of thulium remains almost constant ($190 \pm 30 \text{ ppm}$). In the *Ce* series, the concentration of cerium varies from 0 to 1300 ppm whereas the concentration of thulium remains almost constant ($260 \pm 40 \text{ ppm}$).

Table 1
Concentrations of all elements incl. oxygen (ppm.at).

Series	[<i>Tm</i>]	[<i>La</i>]	[<i>Ce</i>]	[<i>Al</i>]
<i>Tm</i>	0–600	–	–	~ 8000
<i>La</i>	190 ± 30	0–7000	–	~ 8000
<i>Ce</i>	260 ± 40	–	0–1300	~ 8000

3. Experimental setups

Photo-darkening, fluorescence lifetime and fluorescence measurements were performed in this study.

3.1. Photo-darkening

Fig. 1 describes the experimental setup used to measure the PIA. The pump laser at $1.07 \mu m$ is a continuous wave *Yb*-doped fibre laser (Keopsys, KPS-CUS-OEM-1064). It was coupled into a commercial passive fibre (Corning, HI-1060, referred to as “input fibre”) through a telescope, a high reflection dielectric mirror, a dichroic mirror and an aspherical lens. The dichroic mirror is highly reflective at $1.07 \mu m$ and transparent from 0.55 to $1.0 \mu m$. The input fibre end was cleaved at right angle. The fibre under test (FUT) samples were spliced to the input fibre. The typical length of samples was about 2 cm, short enough to neglect the pump depletion (loss $< 1 \text{ dB}$ at $1.18 \mu m$). Another passive HI-1060 fibre was spliced at the other end of the FUT. A super continuum source (SCS, Leukos SM-30) was coupled into the passive fibre in the counter-propagative direction relative to the pump beam, using two metallic mirrors (not represented) and an aspherical lens. The remaining pump was rejected by a second dichroic mirror, so that the SCS was protected against laser damage. Two band pass filters at $0.55 \mu m$ with a $2 - nm$ bandwidth were placed before and after the FUT. Their extinction ratio is higher than 40 dB . Next, the green beam is called the probe.

The injected pump was measured from the end of the input fibre by a power meter before the splicing of the FUT. The time-resolved PIA measurement was recorded at $0.55 \mu m$ while pumping at $1.07 \mu m$. This probe wavelength was selected because the PIA is strong whereas there is no absorption band of Tm^{3+} ions at $0.55 \mu m$. The band pass filters were placed, the SCS was turned on, and the PWM (Si photo-diode) was used to continuously measure the transmitted probe while pumping. The recording was continued after the laser was turned off, in order to measure bleaching dynamics caused by the probe.

The probe power can affect the measurements. For example, Fig. 2 shows steady state values of photo-induced attenuation for the *Tm*-doped sample containing the highest concentration of *Ce* (1300 ppm) as a function of the probe power. The steady state values of the PIA (PIA_{st}) span from 44 dB/m to 90 dB/m when the probe power increases from 2 nW up to $25 \mu W$. The same trend was observed in the *La* series. To minimize the effect of the probe in the case of *Ce* or *La* doped samples, it is necessary to use a probe power lower than $\sim \mu W$. Therefore photo darkening

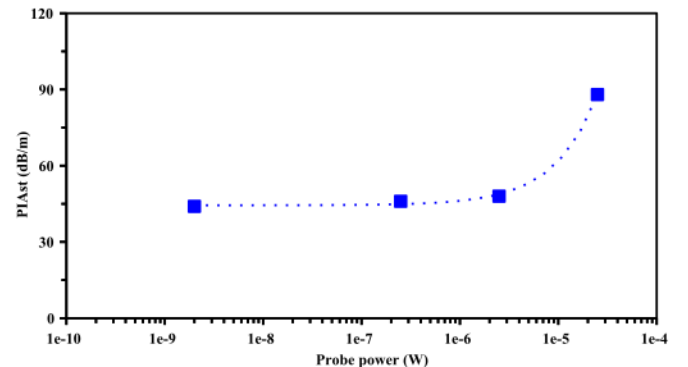

Fig. 2. PIA_{st} values obtained for various probe powers spanning from 2 nW to $25 \mu W$, for pump power of 1 W measured in the 1300 ppm cerium-doped sample. Dot: experimental values, dotted line: linear fitting.

measurements should be performed at these low probe power in order to quantify only the effect of the pump and rare-earth ions concentrations. In the case of singly Tm -doped samples, we have checked that a higher probe power ($25 \mu W$) does not disturb the measurements.

3.2. Fluorescence spectra

The experimental setup used to measure the fluorescence spectra of Tm^{3+} is described in Fig. 1. The pump wavelength was $1.07 \mu m$. For these measurements, the SCS and the filter were not used. The contra-propagative fluorescence was collected and measured by an optical Fourier transform analyser (Thorlabs OSA-201C). The spectra were acquired from $400 nm$ to $1 \mu m$ with different pump powers. All spectra present a parasitic peak at $632.8 nm$ which is due to the intrinsic He-Ne reference inside the device. When the pump power is lower than $250 mW$, photo-darkening can be neglected for few minutes. When the pump power is higher than $500 mW$, the intensity of the emission spectrum is impacted by the photo-darkening particularly in the short-wavelengths domain.

3.3. Fluorescence lifetimes

Fig. 3 describes the experimental setup used to measure the fluorescence lifetime of the 3H_4 level of Tm^{3+} . The pump laser was a fibre coupled laser-diode emitting at $785 nm$. A 50/50 coupler was used to collect the backward fluorescence. The fibre under test was spliced on one of the coupler arms. Both ends are immersed in index liquid to prevent any reflection of parasitic light. The contra-propagative fluorescence was collected, then filtered by a spectrometer tuned to $810 nm$ (resolution $\sim 0.1 nm$). The output light was detected by an amplified avalanche silicon photodiode (APD, EG&G SPCM AQR-14-FC) operated in the photon-counting mode. The TTL electrical pulses from the APD were counted by a Stanford SR400 photon counter synchronized by the laser diode modulation signal. Decay curves were registered using a time-gate scanning across one pump modulation period. In order to minimize errors (laser fluctuations,...) and increase the S/N ratio, the signal was normalized in real time by the signal from a fixed time-gate integrating the signal over a full $1 - ms$ modulation period, and each data point was averaged 5000 times. A decay curve contains typically 500 data points.

4. Rate equation model

In this section, we present the model used to discuss the darkening and the bleaching phenomena. It is well-known that light can be absorbed by precursors present in the glass, leading to the formation of color-centres absorbing in the visible. In silica, many different color-centres have been identified. For the sake of simplicity in this model, we consider the formation of one generic

color-centre which can be photo-bleached. In this case, the normalized density n of color-centres is ruled by the generation (g) and the bleaching (b) rates. The time derivative of the number of color-centres \dot{n} has two contributions: (i) $g \cdot (1 - n)$ which is the generation term requiring an exhaustible source, (ii) $-b \cdot n$ which is the bleaching term requiring a color-centre to bleach. These considerations lead to the differential equation (1).

$$\dot{n} = g \cdot (1 - n) - b \cdot n \quad (1)$$

According to the Beer-Lambert law, the generation of one color-centre, characterized by the absorption coefficient α_{cc} , leads to the photo-induced absorption $PIA = \alpha_{cc} \cdot n$ (in dB/m). The resolution of equation (1) gives the temporal form of $PIA(t)$:

$$PIA(t) = \alpha_{cc} \cdot \frac{g}{g+b} \left(1 - e^{-(g+b) \cdot t} \right) \quad (2)$$

Equation (2) exhibits two parameters: $PIA_{st} = \alpha_{cc} \cdot \frac{g}{g+b}$ and $\tau_{1/e} = \frac{1}{g+b}$ which are the steady state value of PIA and the characteristic time, respectively. Both parameters can be determined experimentally. Reversed relations are: $\alpha_{cc} \cdot g = \frac{PIA_{st}}{\tau_{1/e}}$ and $(g+b) = \frac{1}{\tau_{1/e}}$. As the value of α_{cc} is unknown, g and b cannot be determined separately.

The measurements of PIA_{st} and $\tau_{1/e}$ allow to discuss on the increase or the decrease of the photo-darkening and the photo-bleaching rates. Indeed, when PIA_{st} increases and $\tau_{1/e}$ decreases, the phenomenon is ruled by the increasing of g . When both PIA_{st} and $\tau_{1/e}$ increase, the phenomenon is ruled by the decreasing of b . When both PIA_{st} and $\tau_{1/e}$ decrease, the phenomenon is ruled by the increasing of b . Finally, when PIA_{st} decreases and $\tau_{1/e}$ increases, the phenomenon is ruled by the decreasing of g . Table 2 synthesises the link between the measured parameters (PIA_{st} and $\tau_{1/e}$) rates of photo-darkening and photo-bleaching.

This model is based on the assumption that only one kind of color-centre is implied. To discuss this statement, Fig. 4 shows one typical decay curve of the PIA fitted with a single, a double and a stretched exponential. The experimental curve was measured in an Al-Tm doped sample pumped at $1 W$ and with a probe at $550 nm$ (power: $25 \mu W$).

The best curve fittings correspond to double and stretched exponential cases. Stretched exponentials are commonly used to describe non-exponential decay curve, but there is no easy interpretation of the stretch parameter. The two-exponentials fitting can be explained by the formation of two color-centres. However, the experimental values of interest (PIA_{st} and $\tau_{1/e}$) are well fitted even with the single exponential decay curve. The single exponential curve fails to fit the intermediate part, which is out of interest in this study. For these reasons, we consider here the formation of one generic color-centre.

5. Results

5.1. Effect of thulium concentration on the photo-darkening

In this subsection, we consider the Tm samples series. The effect

Table 2

Effects of the increase and decrease of PIA_{st} and $\tau_{1/e}$ on the generation and bleaching rates.

PIA_{st}	\uparrow	\uparrow	\downarrow	\downarrow
$\tau_{1/e}$	\downarrow	\uparrow	\downarrow	\uparrow
Ruling rate	$g \uparrow$	$b \downarrow$	$b \uparrow$	$g \downarrow$

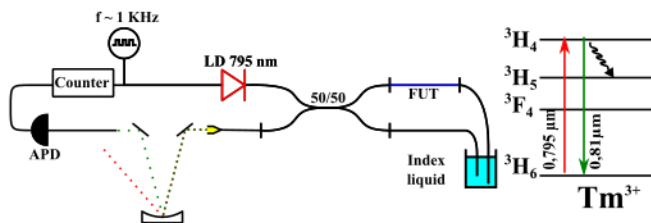

Fig. 3. Experimental setup used to measure the fluorescence lifetime of the 3H_4 level of Tm^{3+} . APD: avalanche photo-diode. FUT: fibre under test.

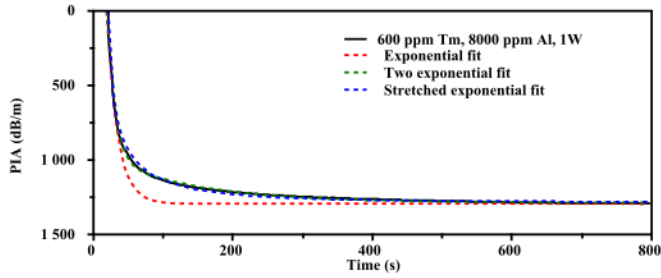

Fig. 4. Time resolved PIA for a sample containing 600 ppm Tm and 8000 ppm Al and three fitting curves. Pump power: 1 W, probe power: 25 μ W.

of thulium concentration on the PIA_{st} and the characteristic time $\tau_{1/e}$ is reported in Fig. 5. As reported previously, when Tm concentration increases from 0 to 600 ppm, PIA_{st} increases from 0 to 1300 dB/m. The data can be fitted with a power law, with an exponent equals to 1/2 for the dependence on Tm concentration (dotted line in the inset of Fig. 5) [18]. The same trend was observed in Yb-doped silica with varying Tm concentration and probe light at 633 nm [13]. The characteristic time decreases from 115 to 6 s when Tm concentration increases from 160 to 600 ppm. For this range of Tm concentration, the characteristic time can be fitted with an exponential law (dotted line in Fig. 5). At concentrations lower than 150 ppm, it is expected that $\tau_{1/e}$ behaviour deviates from this exponential law. Indeed, when Tm concentration tends to 0, PIA_{st} tends to 0 and $\tau_{1/e}$ tends to infinity. According to the data reported in Fig. 5, in the 200–600 ppm range, $\tau_{1/e}$ is very sensitive to the Tm concentration as it varies by a factor 30 while the PIA_{st} varies by a factor 2 only.

The inset of Fig. 6 reports the PIA_{st} values for the sample doped with the highest content of Tm and for pump power (P) varying from 300 mW to 4 W. PIA_{st} values increase with the pump power. These data can be fitted with this law: $PIA_{st} = PIA_{st}^{sat} \frac{A \cdot P}{1 + A \cdot P}$ where $A = 0.86 \text{ W}^{-1}$ and $PIA_{st}^{sat} = 2700 \text{ dB/m}$. The variation of the characteristic time $\tau_{1/e}$ versus P is reported in Fig. 6. These values are fitted with a power law whose exponent is -5.29 and -1.72 when pump power is lower or higher than 0.7 W, respectively. In the case of Yb-doped silica fibres, a power-law dependence was reported and the exponent was associated to the number of photons implied in the photo-darkening process [21]. Based on this consideration, at low pump power, the phenomenon would be ruled by the absorption of 5 or 6 photons while at higher pump power only 1 or 2 photons would be involved. These two processes can be tentatively

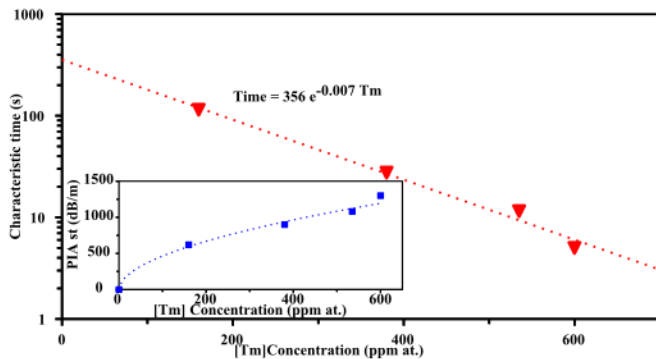

Fig. 5. Characteristic time for various thulium concentrations, from 0 to 600 ppm and 8000 ppm Al. Measured at 1 W pump power and 25 μ W of 550 nm probe. Dot: experimental data, dotted lines: exponential fitting. Inset: PIA_{st} corresponding, Dot: experimental data, dotted line: square-root fitting.

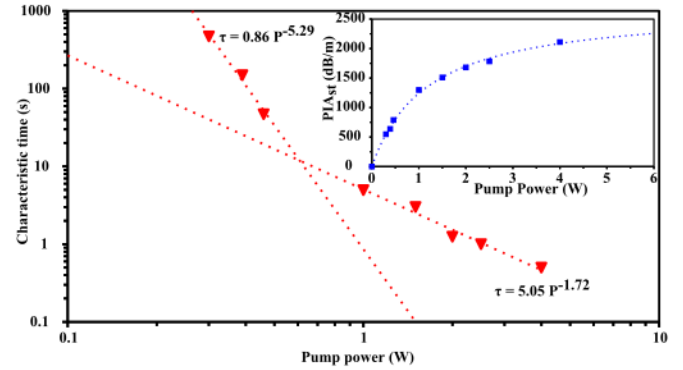

Fig. 6. Characteristic times for the 600 ppm Tm and 8000 ppm Al sample, for pump powers spanning from 300 mW to 4 W, measured at 550 nm. Dot: experimental data, dotted lines: power law fittings. Inset: PIA_{st} values for the same measurements. Dot: experimental data, dotted lines: fitting with saturate linear.

interpreted as follows.

For the sample with the highest Tm concentration, the emission spectra were measured under 1.07 μ m pumping scheme with pump power varying between 0 and 4 W. A characteristic emission spectrum is reported in Fig. 7 and corresponds to the pump power of 250 mW. For higher pump power, the emission spectra in the visible domain are difficult to measure due to the photo-darkening effect. The emission spectrum exhibits three emission bands at 470, 530 and 650 nm. These emission bands are attributed to Tm^{3+} ions. Blue and red emissions can be attributed to de-excitations from the 1G_4 manifold. This level is populated through up-conversion mechanism (3-photon absorption) described in Fig. 1. The green emission band is emitted from energy levels higher than the 1G_4 . The 1D_2 level can be populated through energy transfer between two Tm^{3+} ions: a Tm^{3+} ion absorbs a pump photon to reach the 3H_5 level and decays non-radiatively to the 3F_4 level. Then, the energy transfer ($^3F_4, ^1G_4$) \rightarrow ($^3H_6, ^1D_2$) takes place as already observed in fluoride glass [22]. From the 1D_2 level, the Tm^{3+} ion can absorb another pump photon to reach the $^3P_{0,1,2}$ and 1I_6 levels. According to these processes, reported in Fig. 1, the absorption of 5 pump photons leads to the emission of UV light. These UV photons are expected to be involved in the photo-darkening process because they can ionize precursor defects such as the Al-E' and NBOHC centres [14,23–25]. In this case, electrons are released in the conduction band and holes in the valence band. These charges can then recombine on traps to form color-centres: the AlOHC in the case of

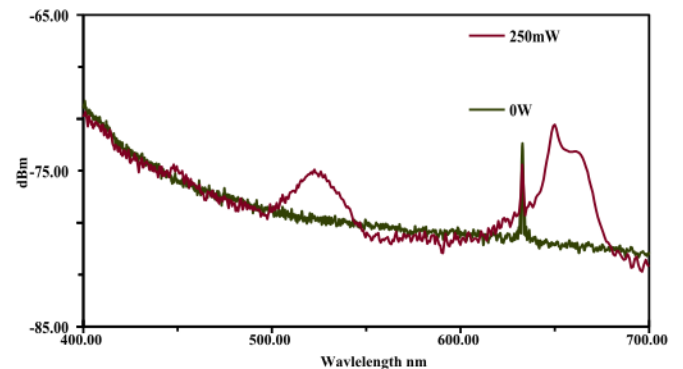

Fig. 7. Visible-NIR fluorescence under 1.07 μ m pumping, for the sample doped with 600 ppm Tm and 8000 ppm Al. Res: 1 nm, peak at 632.8 nm: artefact from OSA.

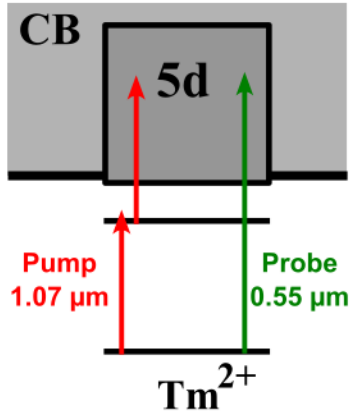

Fig. 8. Schematic representation of bleaching mechanisms by Tm^{2+} ion. Red: pump photon, green: probe. CB: Conduction band. (For interpretation of the references to colour in this figure legend, the reader is referred to the web version of this article.)

hole, or, in the case of electron, on a Tm^{3+} to form a Tm^{2+} . $AlOHC$ and Tm^{2+} absorb in the visible [26]. As a conclusion, at low pump power, the variation of the characteristic time is associated to the generation of color-centres due to the UV emission induced by the 5-photon absorption mechanism of Tm^{3+} (see Fig. 8).

For pump power higher than 0.7 W, thulium ions undergo a similar effect as the induced transparency. Indeed, there is a competition between the absorption of pump photon on the $^3H_4 \rightarrow ^1G_4$ transition and the stimulated emission of the opposite transition. Then, at high pump power, populations of the 3H_4 and 1G_4 levels are saturated and the ratio of these populations is the ratio of the absorption cross-sections and associated emission cross-sections. If these populations are saturated, it can be deduced that the pump has no more interactions with Tm^{3+} ions and therefore the generation of color-centres saturates.

For pump power higher than 1 W, PIA_{st} starts to saturate and the characteristic time evolves differently as the exponent of the power law is between 1 and 2. The ground level of the Tm^{2+} ions, initially present in the glass or induced by UV emission, is located close to the bottom of the conduction band (~ 1.9 eV) [27,28]. Moreover, the $4f-4f$ transition of Tm^{2+} occurs at ~ 1 eV [26,29,30]. Then, only one probe photon (~ 2.25 eV) or two pump photons (~ 1.16 eV each) suffice to ionize Tm^{2+} ions (see Fig. 8). Once the Tm^{2+} ion is ionized, it becomes a Tm^{3+} and an electron is released in the conduction band. This electron can recombine on a Tm^{3+} ion, a trap defect or return to its ionized precursor. This last case allows to bleach the degradation.

5.2. Effect of cerium and lanthanum concentrations on the photo-darkening under pumping

The characteristic times and the PIA_{st} values for different concentrations of Ce and La are reported in Figs. 9 and 10, respectively. In both cases, as the rare-earth ion concentration increases, PIA_{st} and characteristic time decrease. Ce reduces PIA_{st} from 720 to 42 dB/m and the characteristic time from 150 to 15 s. La reduces PIA_{st} from 675 to 250 dB/m and the characteristic times from 250 to 6 s.

The characteristic time and PIA_{st} values have been measured for the sample with the highest concentration of Ce for different pump powers. The data are reported in Fig. 11. As already observed in the case without Ce (cf Fig. 6), the PIA_{st} increases with the pump power. Data were fitted with the law $PIA_{st} = PIA_{st}^{sat} \frac{AP}{1+AP}$ where

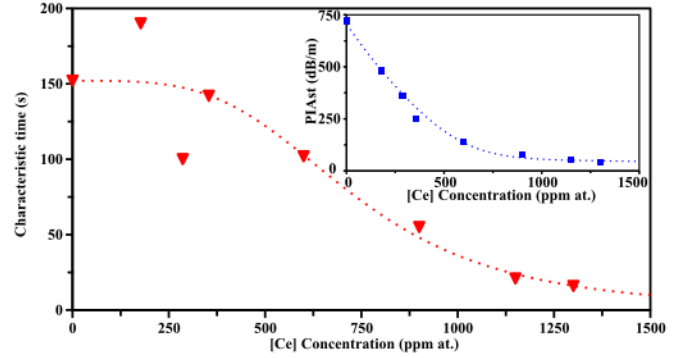

Fig. 9. Characteristic times and PIA steady state values (inset) as a function of cerium concentration. Pump power: 1 W, probe power: 2 nW. Dot: experimental values, dotted lines: fittings explained in the text.

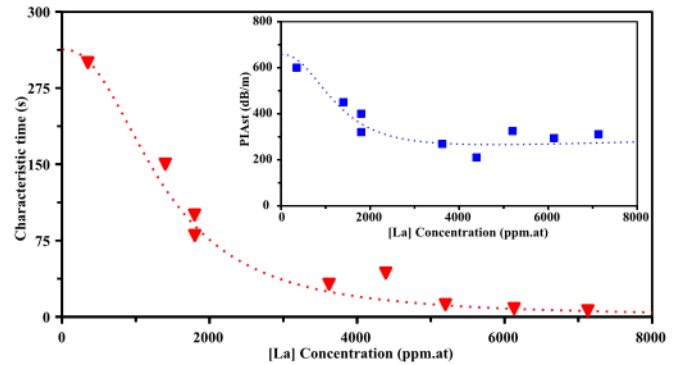

Fig. 10. Characteristic times and PIA steady state values (inset). Pump power: 1 W, probe power: 2 nW. Dot: experimental values, dotted lines: fittings explained in the text.

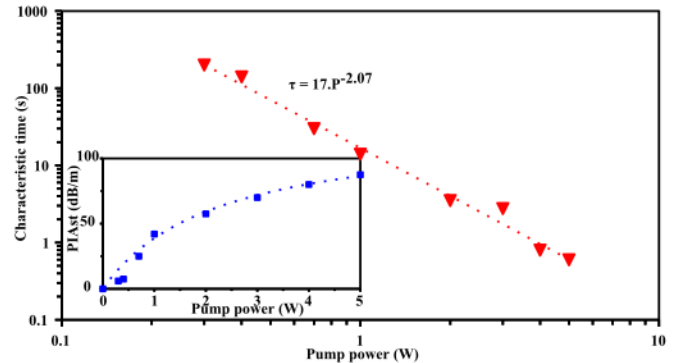

Fig. 11. Characteristic times and PIA steady state values (inset) for the 1300 ppm cerium-doped sample as a function of pump power. Dot: experimental data, dotted lines: fitting in saturate linear for PIA_{st} and with a power law for the characteristic times.

$PIA_{st}^{sat} = 125$ dB/m and $A = 0.45$ W^{-1} . The fitting is good except for some data at low pump power. Indeed, at low pump power the equilibrium level is low. Then, a longer length of fibre (~ 8 cm) was required, and the equilibrium values were undervalued. In comparison with cerium-free samples, the PIA_{st}^{sat} value is significantly reduced by a factor of 22, and the parameter A is reduced by a factor of ~ 2 . The values of characteristic time as a function of the pump power are fitted by a single power law, with an exponent of ~ 2 . On the contrary to the case of Ce -free samples (cf Fig. 6), there is no trend with an exponent of 5 or 6 at low pump power. So, this

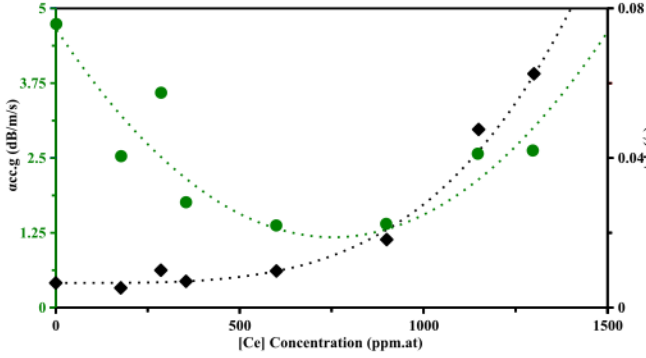

Fig. 12. $\alpha_{cc.g}$ et $g+b$ as a function of Ce concentration. Symbol: experimental values, dotted lines: fittings.

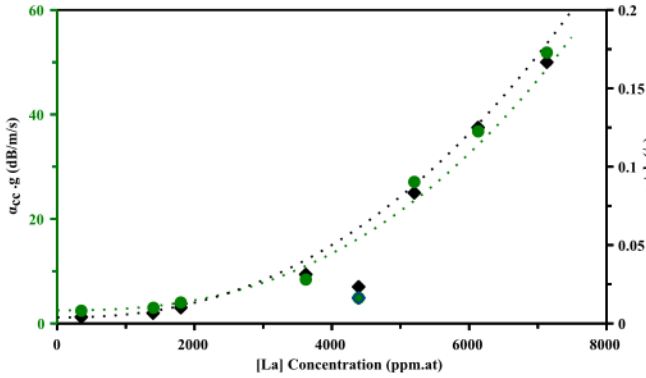

Fig. 13. $\alpha_{cc.g}$ et $g+b$ as function of the lanthanum concentration. Symbol: experimental values, line: adjustments in power laws.

strongly suggests that the photo-darkening dynamics would be ruled by bleaching, namely the photo-bleaching by the pump.

The characteristic times and PIA_{st} values are then interpreted. The $\alpha_{cc.g}$ and $g+b$ parameters as a function of Ce and La concentrations are shown in Figs. 12 and 13, respectively.

In the case of Ce-doped samples, $\alpha_{cc.g}$ parameter has a non-monotonic behaviour. From 0 to 750 ppm of cerium, this parameter decreases from 4.8 to 1.25 dB/m/s while it increases when cerium concentration is higher than 750 ppm. These measurements are fitted with a second order polynomial function and a satisfying match is found (green dotted curve in Fig. 12). The parameter $g+b$ is quite stationary at low Ce concentration, then it increases. These data are fitted with a power law (the exponent is 3.71) and a good match is also found (black dotted curve in Fig. 12). At low concentration of cerium, g decreases and $g+b$ stays constant, meaning that b increases. At higher concentration of cerium, g and $g+b$ increase. Consequently it is impossible to determine the variation of b .

For La-doped samples, the value of $\alpha_{cc.g}$ increases by one order of magnitude, from 5 to 50 dB/m/s as the lanthanum concentration increases from 0 to 7000 ppm. For the same range of concentration, the parameter $g+b$ changes from 0.005 to 0.17 /s. These data were fitted by two different power laws. The exponents are 2.5 and 2.3 for $\alpha_{cc.g}$ and $g+b$ curves, respectively. The difference between these two exponents may seem low but no simultaneous satisfying agreement is found for the four charts (Figs. 10 and 13) with equal exponents. As both g and $g+b$ increase, it is not possible to discuss confidently on the variation of each parameter.

An inverse mathematical transformation is applied to derive the fitting of PIA_{st} and $\tau_{1/e}$ data (dotted curves in Figs. 9 and 10). A good

matching is found for all the data except for two concentrations of Ce (~ 250 ppm). These two samples have different concentrations of Tm compared to the other samples of the series: Tm concentration is 240 and 350 ppm in the '180 ppmCe' and '260 ppmCe' samples, respectively. As already indicated in Fig. 5, any change in Tm concentration strongly impacts the characteristic times and, to a less extent, PIA_{st} values.

5.3. Effect of cerium and lanthanum concentrations on the photo-darkening after pumping with high probe power

The variations of PIA versus time for three concentrations of Ce and La are reported in Figs. 14 and 15, respectively. Before "Pump stop", the pump laser is on and its power is 1 W. At "Pump stop", the pump laser is switched off and the probe power remains the same.

After the pump is turned off, the rare-earth ion (Ce or La) concentrations influence the recovery of the photo-darkening. The higher the rare-earth ions concentrations, the higher the recovery. One can note that at $t = 3600$ s (Fig. 14), the PIA absolute value increases suddenly for the sample without cerium. We assume that this increase is due to the vanishing of the green light emitted by Tm^{3+} under pumping.

Cerium-doped samples exhibit stronger photo-bleaching dynamics than the La ones. However, the bleaching is not complete, even after a long time. Such bleaching effects have been observed previously in cerium-doped fibre under UV excitation [31] and more recently in ytterbium doped fibre [32–34] and ytterbium-cerium co-doped fibre under pumping at 976 nm [35,36]. But the role of cerium on these effects was not discussed and probe powers were not specified.

5.4. Fluorescence lifetimes of the 3H_4 : Tm^{3+} -level

Fluorescence lifetime measurements were performed on all samples series. The monitored emission issued from the 3H_4 level of Tm^{3+} is very sensitive to the phonon energy. For all measurements, the decay curves were non-exponential. Then, we considered the $1/e$ values for the lifetimes, reported in Fig. 16. For all these samples, the aluminum concentration remains constant around ~ 8000 ppm. So, we assume that the variation of fluorescence lifetimes are only caused by rare-earth ion concentrations.

For Tm samples series, the fluorescence lifetime remains constant (about 19.5 μ s) when the concentration of Tm varies between 160 and 600 ppm. Despite a quite high concentration of Tm, no quenching was reported in these samples. Interestingly, Ce and La have opposite effect: Ce decreases the fluorescence lifetime (-2.8 μ s/1000 ppm) while La increases it ($+1.5$ μ s/1000 ppm).

The increase of the Tm^{3+} lifetime is discussed in the light of previous studies related to the effect of the local phonon energy on

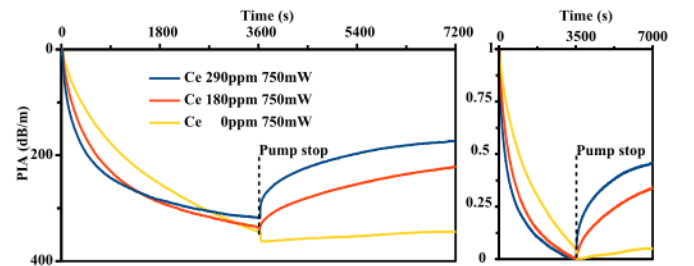

Fig. 14. Left: Time resolved PIA measurements for various Ce concentrations. Pump power before "Pump stop": 750 mW (0 W after "Pump stop"), probe power: 25 μ W. Right: same measurements with normalized PIA curves.

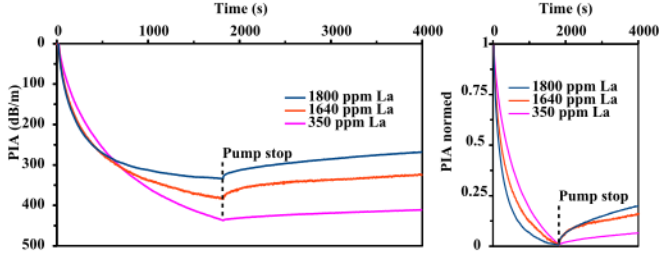

Fig. 15. Left: Time resolved PIA measurements for various *La* concentrations. Pump power before “Pump stop”: 750 mW (0 W after “Pump stop”), probe power: 25 μ W. Right: same measurements with normalized PIA curves.

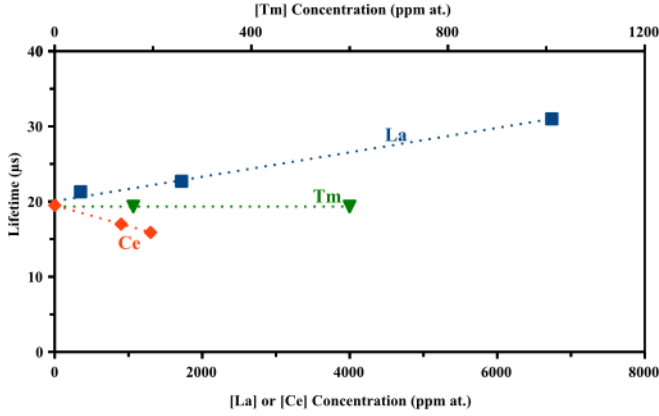
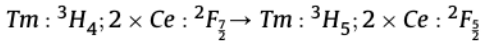

Fig. 16. Fluorescence lifetimes versus concentrations of *Tm*, *La* and *Ce*.

the 3H_4 level lifetime [11,12,37]. The improvement of the *Tm*-fluorescence lifetime can be interpreted in the frame of the change of its local phonon energy (E_p) as previously reported for aluminium [11]. Indeed, a higher content of *La* in the *Tm* environment may decrease the local phonon energy ($E_p(La_2O_3) = 400cm^{-1}$, $E_p(Al_2O_3) = 870cm^{-1}$, $E_p(SiO_2) = 1100cm^{-1}$), then enhance the population in the 3H_4 level, as describe in Ref. [37]. Due to the lower phonon energy of La_2O_3 compared to that of Al_2O_3 , *La* would be more efficient to increase the *Tm*-fluorescence lifetime. The same mechanism would occur with *Ce* but with this ion the lifetime decreases. The decrease of the lifetimes has been reported previously for the $^4I_{1/2}$ level of erbium in tellurium and sulfur based glasses [38–40]. It was explained by an energy transfer mechanism between erbium and cerium ions. As the energy difference between the 3H_4 and the 3H_5 energy levels of Tm^{3+} ($\sim 4000 cm^{-1}$) and between the $^4I_{1/2}$ and the $^4I_{13/2}$ energy levels of Er^{3+} ($\sim 3600 cm^{-1}$) are very close, we hypothesize this energy transfer:



involving one Tm^{3+} ion and two Ce^{3+} ions (the energy difference between the $^2F_{5/2}$ and $^2F_{7/2}$ levels of Ce^{3+} is about $2000 cm^{-1}$). Following this energy transfer, both cerium ions quickly de-excite by emitting two phonons each, and the thulium ion falls into the 3F_4 level.

6. Discussions

In *Tm*-doped fibres, the photo-induced attenuation is due to the balance between the generation and the bleaching mechanisms.

The generation of color-centres is caused by the ability of Tm^{3+} ions to emit UV photons through up-conversion mechanisms when it is pumped at $1.07 \mu m$. This UV photon ionizes a precursor and, depending on the centre, an electron is released in the conduction band and can be trapped by a Tm^{3+} ion to form a Tm^{2+} ion, or a hole is released in the valence band and it can be trapped to form, for example, an *AlOHC* centre. These color-centres can be bleached by absorbing two pump photons or one probe photon. For example, Tm^{2+} ion recovers its initial trivalent state. By adding *Ce* or *La*, both PIA_{st} and characteristic time values decrease. This indicates that these ions would act favourably on the photo-bleaching mechanism (see Table 2).

Cerium addition brings an almost total solution to darkening problem. Indeed, the equilibrium levels drop drastically. An addition of 1300 ppm *Ce* induces a drop of 95 % of degradation level. Cerium ions can decrease *g* for three reasons:

- as fluorescence lifetime decreases (Fig. 16), there are less Tm^{3+} ions in the higher energy levels, then less UV photons are emitted, this can barely affect the generation.
- cerium is known to be present also in its tetravalent state in silica [15,41]. Ce^{4+} can absorb UV photon (charge transfer band) emitted by Tm^{3+} ions to form Ce^{3+} ion which is stable over several months [42,43]. These two valence states of cerium are transparent in the visible [44]. Hence, this phenomenon is in competition with the generation of color-centre and therefore reduces the photo-darkening.
- cerium ion has two valence states, it can trap electron ($Ce^{4+} \rightarrow Ce^{3+}$) and hole ($Ce^{3+} \rightarrow Ce^{4+}$) to the detriment of the formation of color-centres.

Moreover, when RE^{3+} ion is added into aluminosilicate glasses, it acts as a charge compensator if $[RE_2O_3] \leq \frac{[Al_2O_3]}{3}$ (or $[REO_2] \leq \frac{[Al_2O_3]}{4}$ for Ce^{4+}) [45]. As a consequence, RE is located preferentially close to the tetra-coordinated Al^{IV} species. *Ce* and *Tm* compete to be located close to Al^{IV} species. Therefore, *Ce* tends to reduce the probability of *Tm*-cluster formation and hence the emission of UV photons. When cerium concentration is above the threshold of the charge compensator effect, it acts as network modifier and depolymerizes the silica network. This depolymerization may lead to the formation of new precursors defects [46]. This may explain why *g* increases at higher content of cerium.

The bleaching mechanism is related to the ionization of color-centres. In this case, an electron is released in the conduction band. The presence of cerium ions offers a new opportunity for this electron to be trapped by Ce^{4+} , to the detriment of Tm^{3+} ions. The same stands for the ionization of the *AlOHC* centre as the hole released in the valence band can be trapped by Ce^{3+} ions.

On the contrary to cerium ions, the addition of lanthanum tends to increase the fluorescence lifetime which would be a detrimental effect on the photo-darkening. Indeed, this would promote the population of Tm^{3+} in the high energy levels, then the emission of UV photon and the generation of color-centres. However, lanthanum ions allow to reduce photo-darkening. Compared to cerium, lanthanum ion does not absorb UV photon and has only one stable valence state, La^{3+} . The divalent and tetravalent states are not stable in silica [27,28]. An electron has the possibility to recombine on ionized precursor, Tm^{3+} and La^{3+} . If it recombines on La^{3+} , the new valence is not stable and the electron will move away until reaching a stable recombination. Hence, lanthanum addition decreases the probability of recombination on a thulium, and keeps constant the probability of recombination of an ionized precursor.

Therefore, the addition of lanthanum would lead to the increase of the parameter b because it would increase the probability for an electron to return to an ionized precursor. Moreover, as already discussed in the case of cerium ions, at low content of La , this ion could limit the formation of Tm -clusters [47], while at high content, this ion would also act as a network modifier, increasing the numbers of precursor defect [46].

7. Conclusion

Three sets of samples were investigated, all doped with thulium and aluminium and co-doped with cerium or lanthanum. In each series, the impact on photo-darkening of rare-earth ions was studied. The photo-darkening was characterized by its steady state value (PIA_{st}) and also its characteristic time. Thanks to a rate equation model, these parameters were related to the generation and sum of generation and bleaching rates. While PIA_{st} increases with the Tm concentration, the addition of Ce or La allows the PIA_{st} and the characteristic time to reduce. Most importantly, we reveal that the main impact of cerium and lanthanum on photo-darkening is due to their effect on the bleaching mechanisms. This can be explained by the ability of cerium ions to trap holes or electrons. In the case of lanthanum co-doping, the probability for a charge to return to an ionized precursor would be increased by the instability of the divalent and tetravalent states of lanthanum.

Cerium and lanthanum reduce the steady state degradation because they have a strong impact on photo-bleaching. This an increment on the comprehension of darkening process. These results could be transposed to other systems like Yb - or Er -doped fibres in order to enhance actual devices and create new devices and new applications.

Funding

Université Nice Sophia Antipolis, Centre National de la Recherche Scientifique, Agence Nationale de la Recherche (ANR-14-CE07-0016-01, Nice-DREAM).

Acknowledgements

All of the authors want to thank S. Trzesien and M. Ude (INΦNI, Nice, France) for the fabrication of the samples and M. Fialin (IPGP Camparis, Paris, France) for EPMA measurements.

References

- [1] D. Richardson, J. Nilsson, W. Clarkson, High power fiber lasers: current status and future perspectives [invited], *JOSA B* 27 (11) (2010) B63–B92.
- [2] I. Manek-H, J. Boulet, T. Cardinal, F. Guillen, S. Ermeux, M. Podgorski, R.B. Doua, F. Salin, Photodarkening and photobleaching of an ytterbium-doped silica double-clad LMA fiber, *Opt. Express* 15 (4) (2007) 1606–1611.
- [3] H.-J. Otto, N. Modsching, C. Jauregui, J. Limpert, A. Tünnermann, Impact of photodarkening on the mode instability threshold, *Opt. Express* 23 (12) (2015) 15265–15277.
- [4] J. Lægsgaard, Optimizing Yb concentration of fiber amplifiers in the presence of transverse modal instabilities and photodarkening, *Appl. Opt.* 55 (8) (2016) 1966–1970.
- [5] M. Laurila, M.M. Jørgensen, K.R. Hansen, T.T. Alkeskjold, J. Broeng, J. Lægsgaard, Distributed mode filtering rod fiber amplifier delivering 292 W with improved mode stability, *Opt. Express* 20 (5) (2012) 5742–5753.
- [6] M.M. Johansen, M. Laurila, M.D. Maack, D. Noordegraaf, C. Jakobsen, T.T. Alkeskjold, J. Lægsgaard, Frequency resolved transverse mode instability in rod fiber amplifiers, *Opt. Express* 21 (19) (2013) 21847–21856.
- [7] D. Hanna, I. Jauncey, R. Percival, I. Perry, R. Smart, P. Suni, J. Townsend, A. Tropper, Continuous-wave oscillation of a monomode thulium-doped fiber laser, *Electron. Lett.* 24 (19) (1988) 1222–1223.
- [8] X. Zhu, N. Peyghambarian, High-power ZBLAN glass fiber lasers: review and prospect, *Adv. Optoelectron.* (2010), <http://dx.doi.org/10.1155/2010/501956>. Article ID 501956, 23 pages.
- [9] J. Van Dijk, M. Schuurmans, On the nonradiative and radiative decay rates and a modified exponential energy gap law for $4f-4f$ transitions in rare-earth ions, *J. Chem. Phys.* 78 (9) (1983) 5317–5323.
- [10] M. Broer, D. Krol, D. DiGiovanni, Highly nonlinear near-resonant photodarkening in a thulium-doped aluminosilicate glass fiber, *Opt. Lett.* 18 (10) (1993) 799–801.
- [11] B. Faure, W. Blanc, B. Dussardier, G. Monnom, Improvement of the $Tm^{3+} : ^3H_4$ level lifetime in silica optical fibers by lowering the local phonon energy, *J. Non-Cryst. Solids* 353 (29) (2007) 2767–2773.
- [12] W. Blanc, T.L. Sebastian, B. Dussardier, C. Michel, B. Faure, M. Ude, G. Monnom, Thulium environment in a silica doped optical fibre, *J. Non-Cryst. Solids* 354 (2) (2008) 435–439.
- [13] S. Jetschke, S. Unger, A. Schwuchow, M. Leich, J. Fiebrandt, M. Jäger, J. Kirchhof, Evidence of Tm impact in low-photodarkening Yb-doped fibers, *Opt. Express* 21 (6) (2013) 7590–7598.
- [14] M. Engholm, L. Norin, Preventing photodarkening in ytterbium-doped high power fiber lasers; correlation to the uv-transparency of the core glass, *Opt. Express* 16 (2) (2008) 1260–1268.
- [15] M. Engholm, P. Jelger, F. Laurell, L. Norin, Improved photodarkening resistivity in ytterbium-doped fiber lasers by cerium codoping, *Opt. Lett.* 34 (8) (2009) 1285–1287.
- [16] D. Litzkendorf, S. Grimm, K. Schuster, J. Kobelke, A. Schwuchow, A. Ludwig, J. Kirchhof, M. Leich, S. Jetschke, J. Dellith, Study of lanthanum aluminum silicate glasses for passive and active optical fibers, *Int. J. Appl. Glass Sci.* 3 (4) (2012) 321–331.
- [17] S. Jetschke, S. Unger, U. Röpke, J. Kirchhof, Photodarkening in Yb doped fibers: experimental evidence of equilibrium states depending on the pump power, *Opt. Express* 15 (22) (2007) 14838–14843.
- [18] J.-F. Lupi, M. Vermillac, W. Blanc, F. Mady, M. Benabdesselam, B. Dussardier, D.R. Neuville, Steady photodarkening of thulium aluminosilicate fibers pumped at 1.07 μm : quantitative effect of lanthanum, cerium, and thulium, *Opt. Lett.* 41 (12) (2016) 2771–2774.
- [19] J. MacChesney, P. O’connor, H. Presby, A new technique for the preparation of low-loss and graded-index optical fibers, *Proc. IEEE* 62 (9) (1974) 1280–1281.
- [20] J. Townsend, S. Poole, D.N. Payne, Solution-doping technique for fabrication of rare-earth-doped optical fibres, *Electron. Lett.* 23 (7) (1987) 329–331.
- [21] S. Jetschke, U. Röpke, Power-law dependence of the photodarkening rate constant on the inversion in Yb doped fibers, *Opt. Lett.* 34 (1) (2009) 109–111.
- [22] R. Paschotta, P. Barber, A. Tropper, D. Hanna, Characterization and modeling of thulium: ZBLAN blue upconversion fiber lasers, *JOSA B* 14 (5) (1997) 1213–1218.
- [23] L. Skuja, Optical properties of defects in silica, in: *Defects in SiO₂ and Related Dielectrics: Science and Technology*, Springer, 2000, pp. 73–116.
- [24] D.L. Griscom, Defect structure of glasses: some outstanding questions in regard to vitreous silica, *J. Non-Cryst. Solids* 73 (1) (1985) 51–77.
- [25] N. Koumvakalis, Defects in crystalline SiO₂: optical absorption of the aluminum-associated hole center, *J. Appl. Phys.* 51 (10) (1980) 5528–5532.
- [26] Z.J. Kiss, Energy levels of divalent thulium in CaF₂, *Phys. Rev.* 127 (3) (1962) 718.
- [27] P. Dorenbos, Systematic behaviour in trivalent lanthanide charge transfer energies, *J. Phys. Condens. Matter* 15 (49) (2003) 8417.
- [28] P. Dorenbos, Anomalous luminescence of Eu²⁺ and Yb²⁺ in inorganic compounds, *J. Phys. Condens. Matter* 15 (17) (2003) 2645.
- [29] Y.H. Kim, U.-C. Paek, W.-T. Han, J. Heo, Absorption and emission properties of Tm²⁺ ions in germanosilicate glass fibers, *Opt. express* 11 (21) (2003) 2672–2678.
- [30] G.H. Dieke, H. Crosswhite, The spectra of the doubly and triply ionized rare earths, *Appl. Opt.* 2 (7) (1963) 675–686.
- [31] M. Broer, R. Cone, J.R. Simpson, Ultraviolet-induced distributed-feedback gratings in Ce³⁺-doped silica optical fibers, *Opt. Lett.* 16 (18) (1991) 1391–1393.
- [32] A. Jolly, C. Vinçont, J. Boulet, Photo-darkening kinetics in a high-power YDFA versus CW or short-pulse seed conditions, in: *Proc. of SPIE*, vol. 10083, 2017, pp. 100831T–1.
- [33] R. Piccoli, H. Gebavi, L. Lablonde, B. Cadier, T. Robin, A. Monteville, O. Le Goffic, D. Landais, D. Mechin, D. Milanese, T. Brand, S. Taccheo, Evidence of photodarkening mitigation in Yb-doped fiber lasers by low power 405 nm radiation, *IEEE Photonics Technol. Lett.* 26 (1) (2014) 50–53.
- [34] R. Piccoli, T. Robin, T. Brand, U. Klotzbach, S. Taccheo, Effective photodarkening suppression in Yb-doped fiber lasers by visible light injection, *Opt. Express* 22 (7) (2014) 7638–7643.
- [35] S. Jetschke, S. Unger, A. Schwuchow, M. Leich, M. Jäger, Role of ce in Yb/Al laser fibers: prevention of photodarkening and thermal effects, *Opt. Express* 24 (12) (2016) 13009–13022.
- [36] N. Zhao, Y. Wang, J. Li, C. Liu, J. Peng, H. Li, N. Dai, L. Yang, J. Li, Investigation of cerium influence on photo-darkening and photo-bleaching in Yb-doped fibers, *Appl. Phys. A* 122 (2) (2016) 1–5.
- [37] M. Vermillac, H. Fneich, J.-F. Lupi, J.-B. Tissot, C. Kucera, P. Venneguès, A. Mehdi, D. R. Neuville, J. Ballato, W. Blanc, Use of thulium-doped LaF₃ nanoparticles to lower the phonon energy of the thulium’s environment in silica-based optical fibres, *Opt. Mater.*
- [38] Y.G. Choi, K.H. Kim, S.H. Park, J. Heo, Comparative study of energy transfers from Er³⁺ to Ce³⁺ in tellurite and sulfide glasses under 980 nm excitation, *J. Appl. Phys.* 88 (7) (2000) 3832–3839.
- [39] J. Yang, L. Zhang, L. Wen, S. Dai, L. Hu, Z. Jiang, Comparative investigation on energy transfer mechanisms between Er³⁺ and Ce³⁺ (Eu³⁺, Tb³⁺) in tellurite

- glasses, *Chem. Phys. Lett.* 384 (4) (2004) 295–298.
- [40] S. Shen, B. Richards, A. Jha, Enhancement in pump inversion efficiency at 980 nm in Er^{3+} , $\text{Er}^{3+}/\text{Eu}^{3+}$ and $\text{Er}^{3+}/\text{Ce}^{3+}$ doped tellurite glass fibers, *Opt. Express* 14 (12) (2006) 5050–5054.
- [41] S. Unger, A. Schwuchow, S. Jetschke, S. Grimm, A. Scheffel, J. Kirchof, Optical properties of cerium-codoped high power laser fibers, *SPIE OPTO* 8621 (2013) 16.
- [42] M. Raukas, S. Basun, W. Van Schaik, W. Yen, U. Happek, Luminescence efficiency of cerium doped insulators: the role of electron transfer processes, *Appl. Phys. Lett.* 69 (22) (1996) 3300–3302.
- [43] L. Dong, P. Wells, D. Hand, D.N. Payne, Photosensitivity in Ce^{3+} -doped optical fibers, *JOSA B* 10 (1) (1993) 89–93.
- [44] M. Fasoli, A. Vedda, A. Lauria, F. Moretti, E. Rizzelli, N. Chiodini, F. Meinardi, M. Nikl, Effect of reducing sintering atmosphere on Ce-doped sol–gel silica glasses, *J. Non-Cryst. Solids* 355 (18) (2009) 1140–1144.
- [45] P. Florian, N. Sadiki, D. Massiot, J. Coutures, ^{27}Al NMR study of the structure of lanthanum-and yttrium-based aluminosilicate glasses and melts, *J. Phys. Chem. B* 111 (33) (2007) 9747–9757.
- [46] C. Karras, D. Litzkendorf, S. Grimm, K. Schuster, W. Paa, H. Stafast, Nonlinear refractive index study on $\text{La}_2\text{O}_3\text{-Al}_2\text{O}_3\text{-SiO}_2$ glasses, *Opt. Mater. Express* 4 (10) (2014) 2066–2077.
- [47] J.L. Philipsen, J. Broeng, A. Bjarklev, S. Helmfrid, D. Bremberg, B. Jaskorzynska, B. Palsdonir, Observation of strongly nonquadratic homogeneous upconversion in Er^{3+} -doped silica fibers and reevaluation of the degree of clustering, *Quantum Electron. IEEE J.* 35 (11) (1999) 1741–1749.