

BEHAVIORAL MODELLING TAKING INTO ACCOUNT AGEING EFFECTS FOR IC'S IMMUNITY PREDICTION

Geneviève DUCHAMP

Tristan DUBOIS

September 8, 2017

Motivations

Electromagnetic compatibility consideration

- Decrease of biasing voltage
- Increase of operating frequency
- Increase of electronic complexity
- Expensive tests performed at the beginning of product life and
- what about EMC compliance during life time ?

Ageing consideration

- Operational environment : more and more harsh
- Modification of electrical behavior of component
- Expensive tests



Needs:

- Know the impacts of ageing on EMC
- Develop modeling tool taking into account EMC behavior during the life time of a system



- Behavioral modelling approach
- Taking into account effects of thermal and electrical stress on the immunity in the model

Studied component

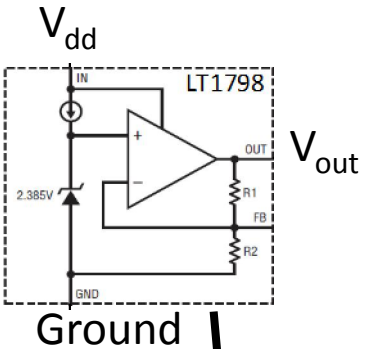

LT 1798:
Voltage reference
 $V_{dd} = 2.7\text{ V} - 12.6\text{ V}$
 $V_{out} = 2.5\text{ V} \pm 0.003\text{ V}$
Operating temperature range :
- 40°C – 100°C

Most decoupling capacitors have been removed



Top layer

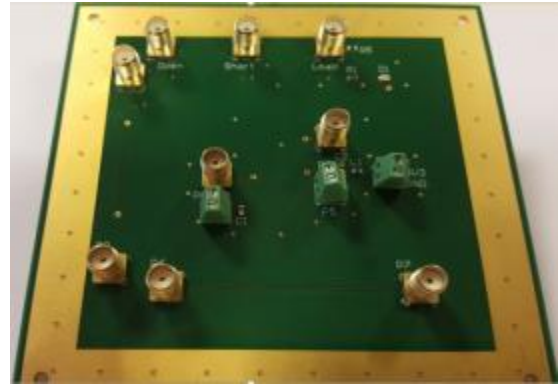

Bottom layer

Behavioral modelling approach

ICIM-CI (Integrated Circuit Immunity Model-Conducted Immunity)-IEC 62433-4 Standard

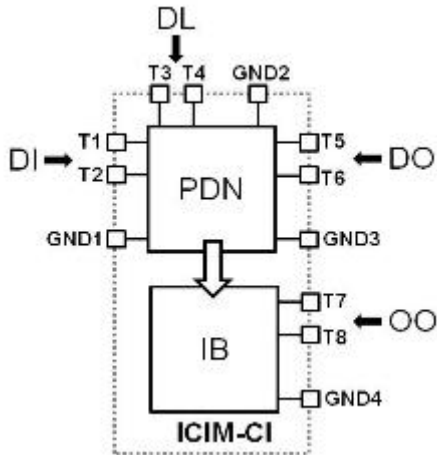

- **PDN (Passive Distribution Network):** describes the impedance network of one or more IC ports with passive elements (resistors, capacitors, inductors) usually obtained from S-parameters measurements
- **IB (Immunity Behavioral):** describes how ICs react to disturbances - usually obtained from DPI (Direct Power Injection) measurements
- Multiport circuit: DI/DO: disturbance inputs/outputs
DL: disturbance loads OO: observable outputs

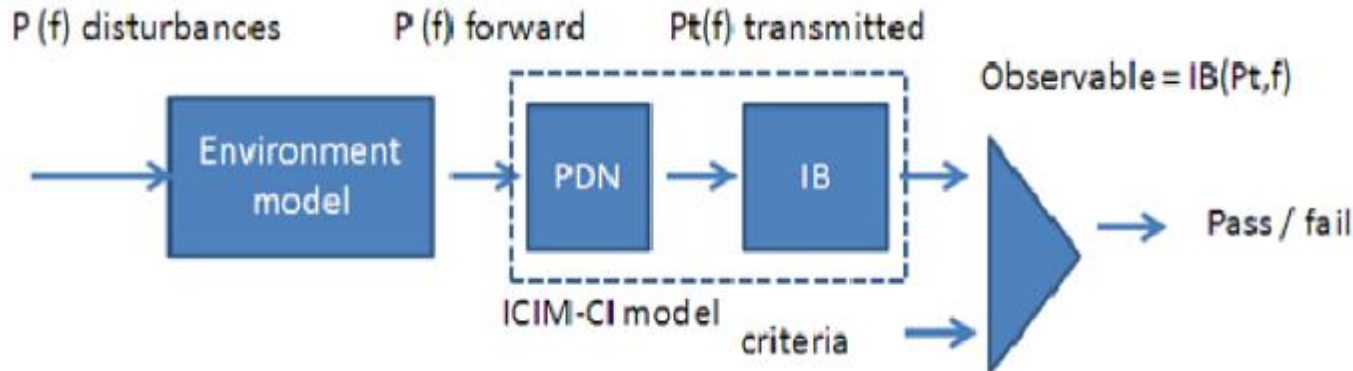

Model output finally compared to an application-dependent user-definable threshold

Behavioral modelling approach

How to proceed?

Injection of disturbances through different ports of the DUT (Device Under Test) => V_{dd} and then V_{out} pins.

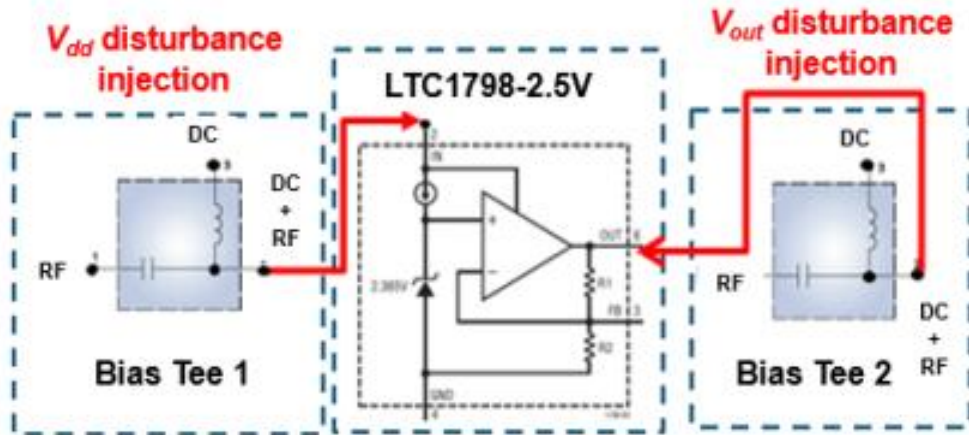

ICIM-CI model structure

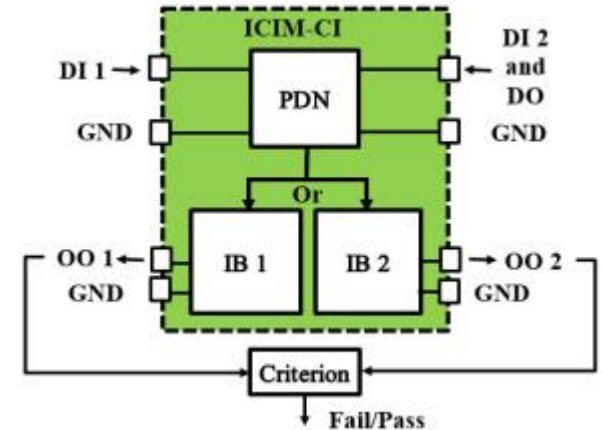

OO: observable output
DI: disturbance input

Behavioral modelling approach

- First step: immunity modelling before ageing
 - PDN extraction
 - IB blocks modelling

- Second step: ageing phase
 - Monitored test
 - Study of ageing effects

- Third step: immunity model taking into account ageing impact

Immunity measurement setup : DPI

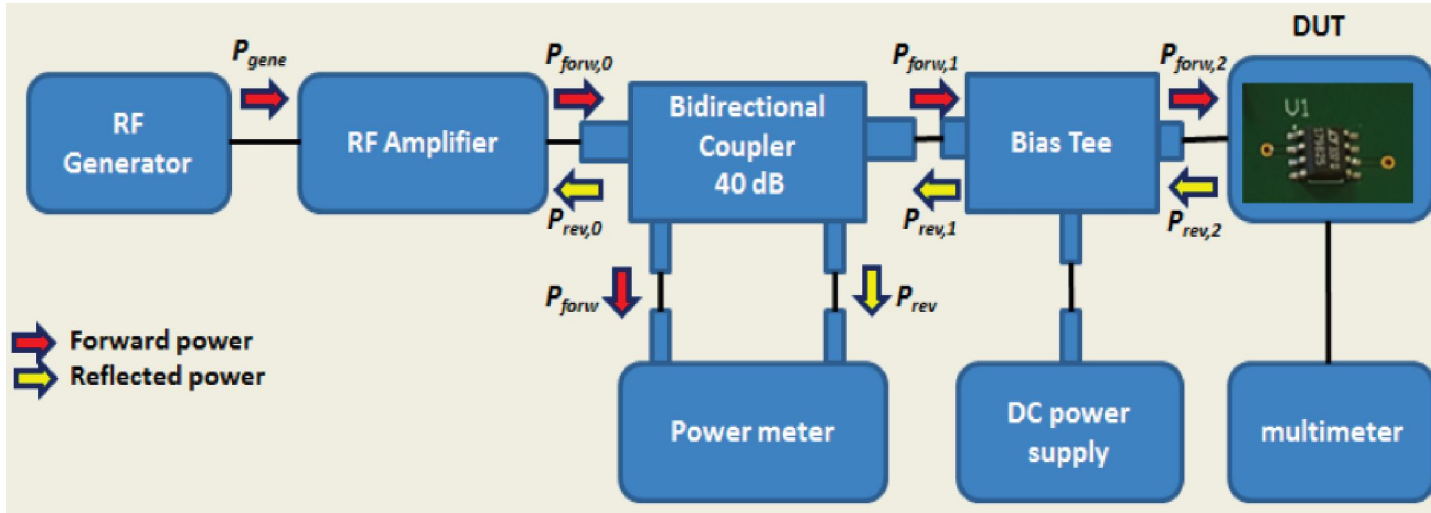

$$P_{trans} = P_{forw} - P_{rev}$$

De-embedding process

$$P_{trans,2} = P_{forw,2} - P_{rev,2}$$

Taking into account the losses of the test bench during the measurements

Immunity behavior and model before ageing : PDN building

Electrical schematic: paramS between V_{dd} and V_{out} - DUT polarised at 3.3V

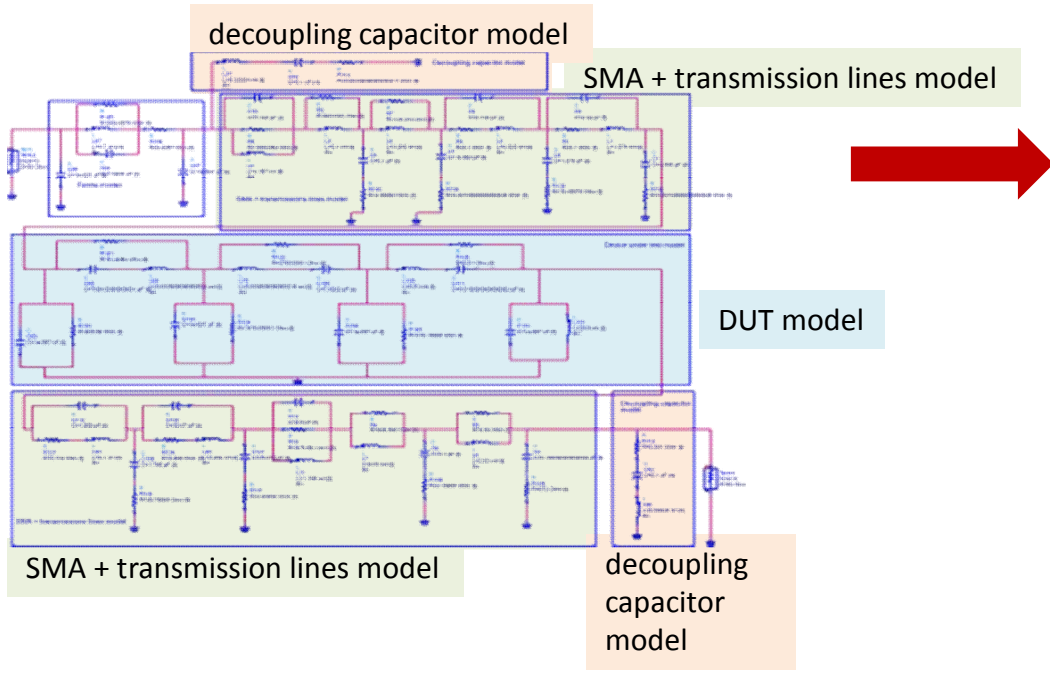

S-parameters: comparison between measurements (green curves) and simulation (proposed model)

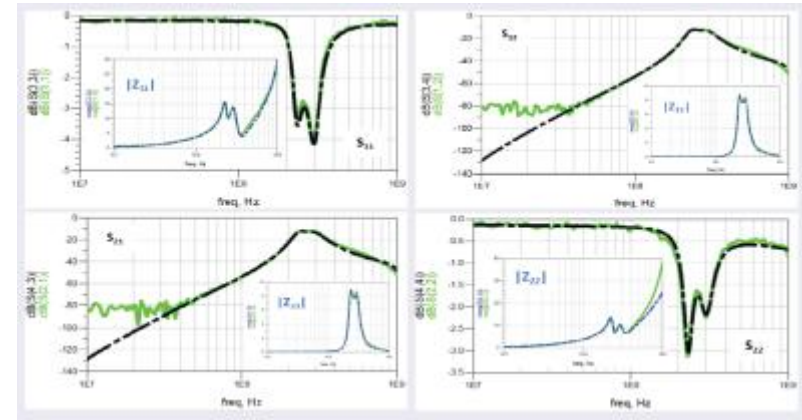

Validation

Good agreement between model and measurements

Hairoud, S. & al., "Multiport ICIM-CI modeling approach applied to a bandgap voltage reference", EMC Europe, 2016.

Immunity behavior and model before ageing : IB blocks building

Injection through V_{dd}

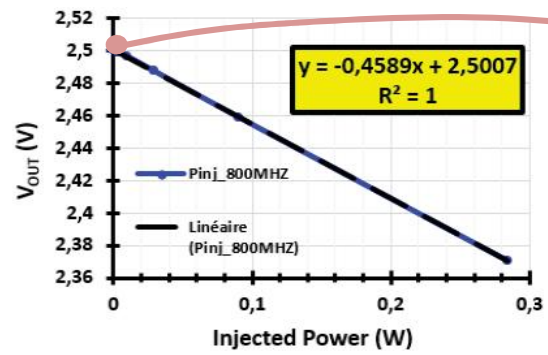

$$V_{out} = V_{ref} + C_{in}(f) * P_{forw}$$

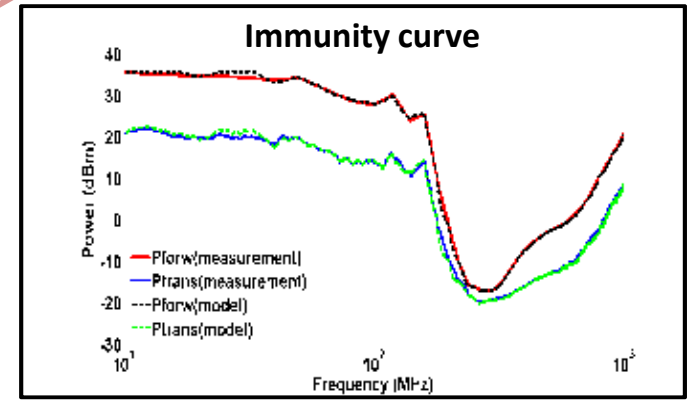

- Linear decrease of the output voltage as a function of the injected power

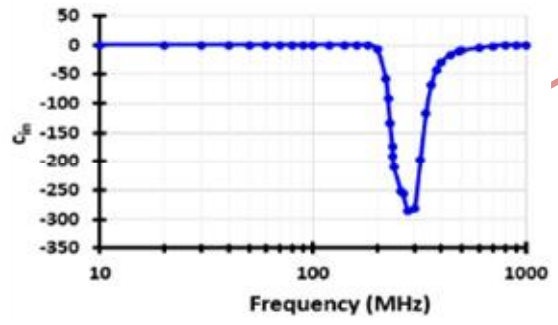

- **Validation of the IB modeling**

- Dependency of the c_{in} as a function of the injected frequency

Hairoud, S. & al., "Multiport ICIM-CI modeling approach applied to a bandgap voltage reference", EMC Europe, 2016.

Immunity behavior and model before ageing : IB blocks building

Injection through V_{out}

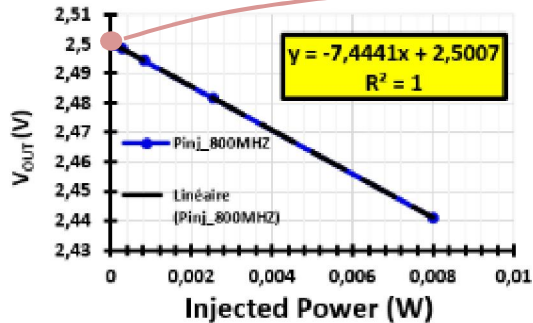

- Linear decrease of the output voltage as a function of the injected power

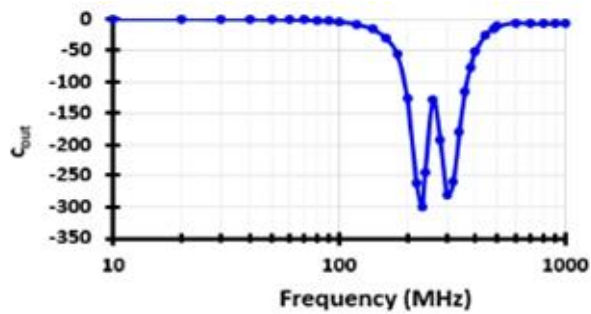

- Dependency of C_{out} as a function of the injected frequency

$$V_{out} = V_{ref} + C_{out}(f) * P_{forw}$$

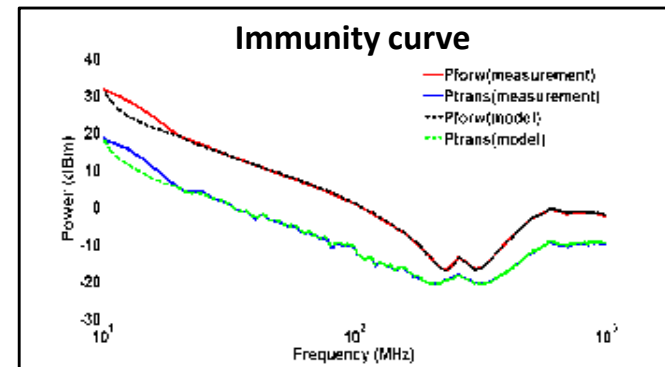

- Validation of the IB modeling**

Immunity behavior: impact of aging ?

➤ Impact on S- parameters ?



Modification of PDN

➤ Impact on immunity behaviour ?



Modification of IB blocks

Any effect of ageing ?

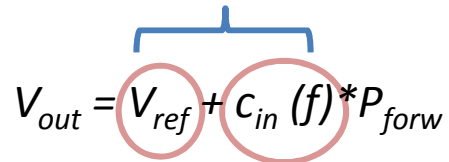
$$V_{out} = V_{ref} + C_{in}(f) * P_{forw}$$

Any effect of ageing ?

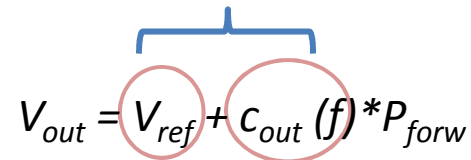
$$V_{out} = V_{ref} + C_{out}(f) * P_{forw}$$

Ageing Test Bench and DUT configuration

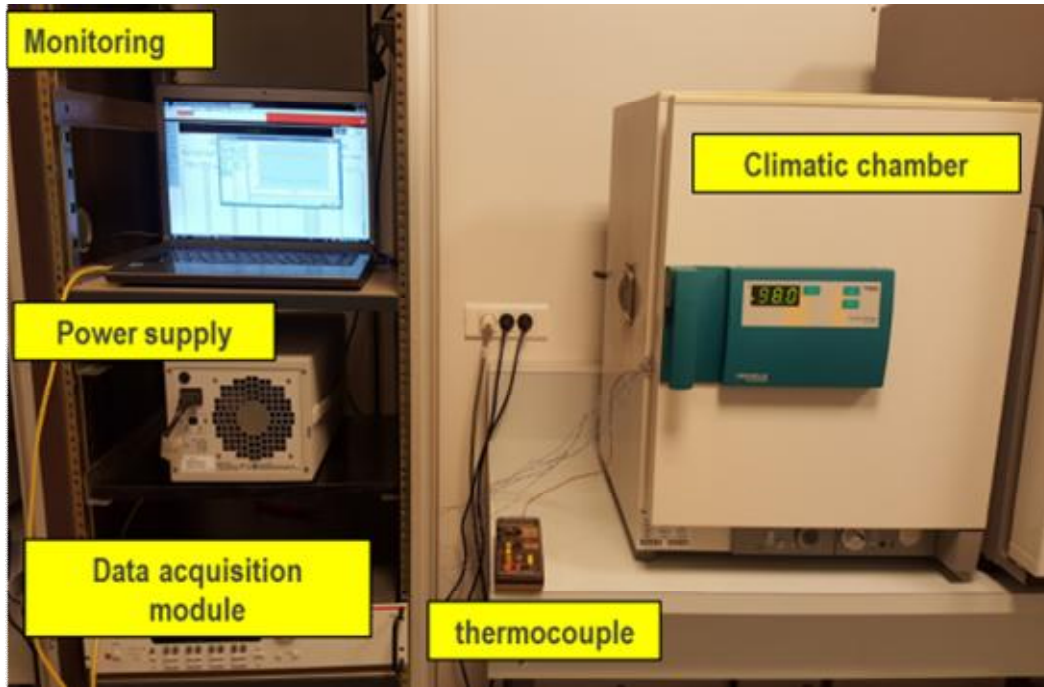

T: climatic chamber temperature is controlled

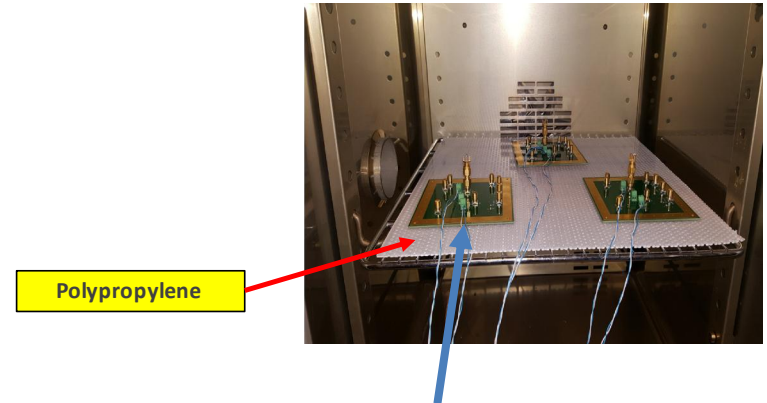

Load increasing the biasing current

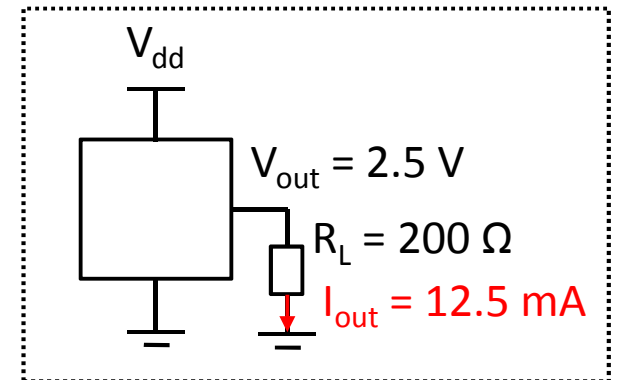

Aging Test Procedure

Main goal Circuit aging \longrightarrow study of immunity evolution (or not)

Two phase test

Test 1: Electrical step + Temperature stress

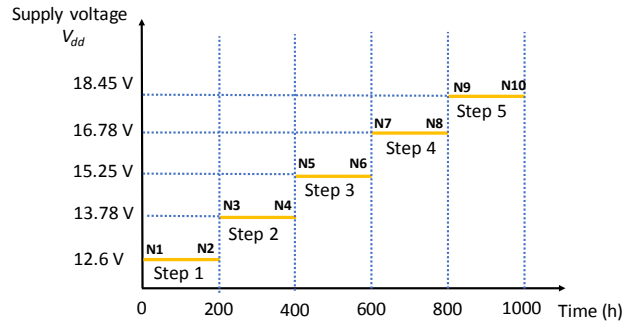

T fixed
Electrical step stress: V_{dd} increase step by step until failure

Test 2: Electrical + Temperature stress

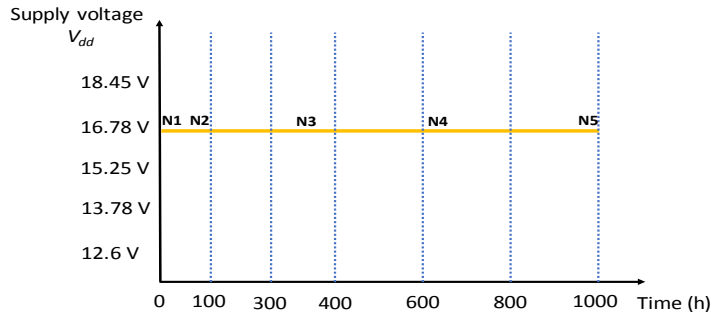

Electrical stress: level before failure previously obtained
T fixed

Test 1 Procedure

Test 1: Electrical step + Temperature stress

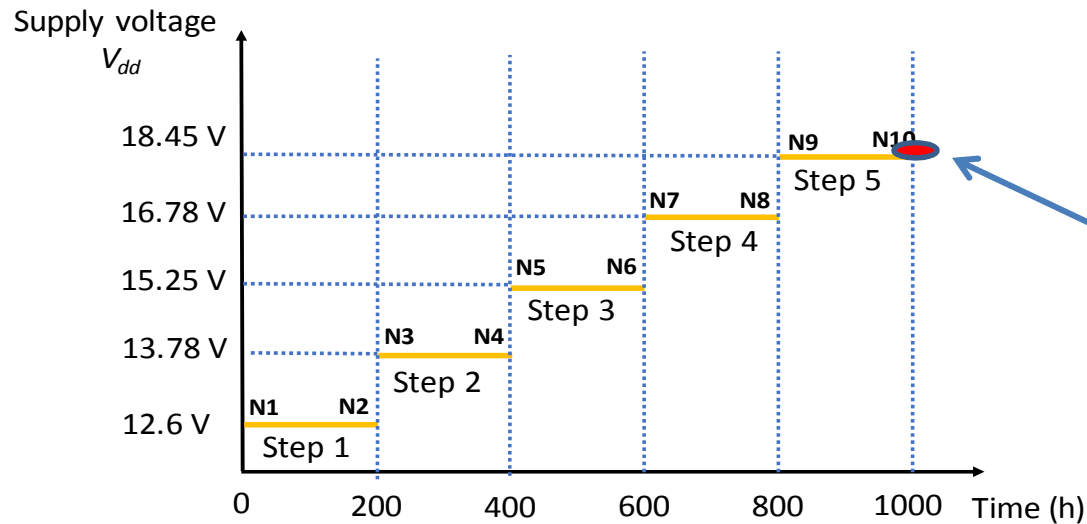

$T = 100^{\circ}\text{C}$

Electrical step stress: 10% increase at each step

Applied until failure

Effect of ageing on immunity performances - Test 1

Output voltage monitoring

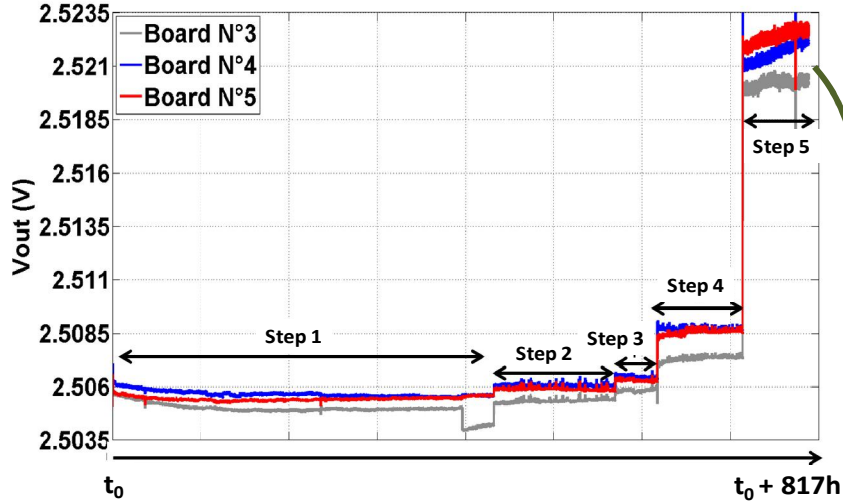

	Vdd	time
step 1	12.6V	217hr
step 2	13.86V	240hr
step 3	15.25V	192hr
step 4	16.78V	144hr
step 5	18.45V	24hr

Component failure : a bit more 24 h after step stress 5

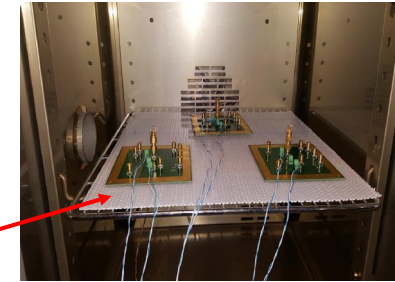

- increase of the output voltage right after each electrical step stress
- the ageing time seems not to modify the output voltage except during step 5

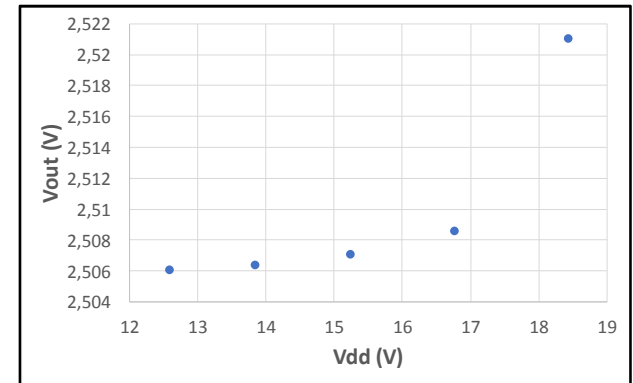

Effect of ageing on immunity performances - Test 1

S-parameters (PDN)

Measurements performed after each stress step – with polarized IC

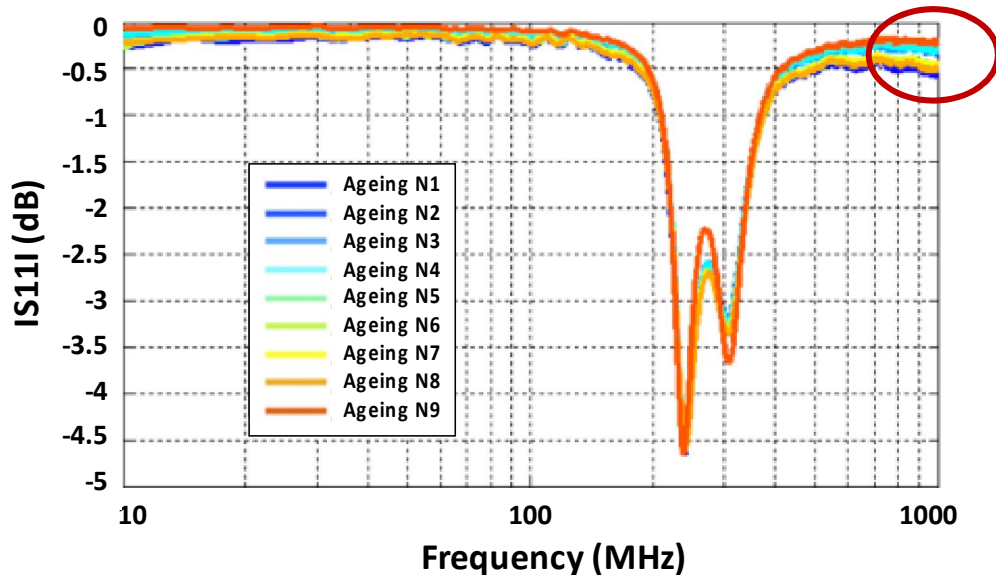

- Progressive evolution of $|S_{11}|$ with ageing time especially at “high frequency”



No need to be taken into account in the PDN model

Effect of ageing on immunity performances - Test 1

IB blocks

$$V_{out} = V_{ref} + C_{in/out}(f) * P_{forw}$$

Effect of ageing ?

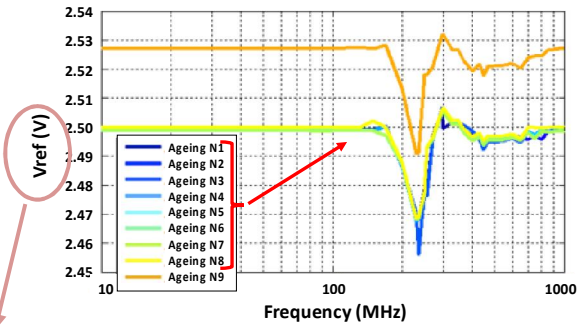

- V_{ref} dependent on ageing

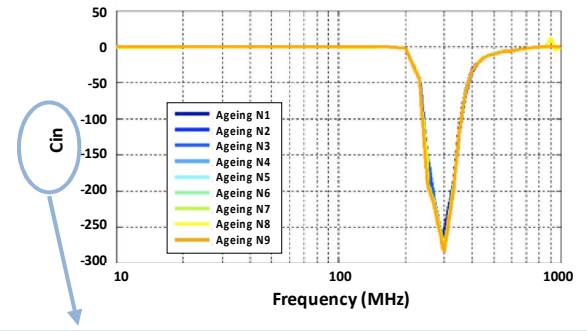

- C_{in} coefficient independent of ageing

None intrinsic immunity change

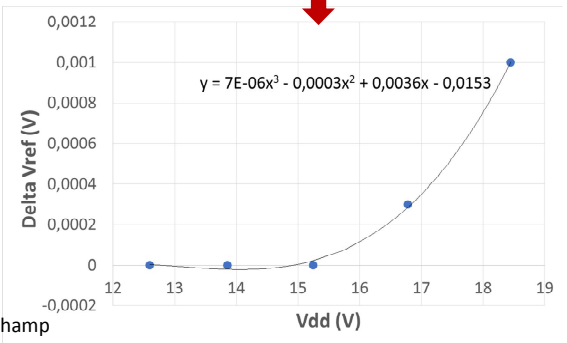

$$\Delta V_{ref} = f(V_{dd})$$

Easy implementation in ICIM-CI model

Test 2 Procedure

Test 2: Electrical + Temperature stress

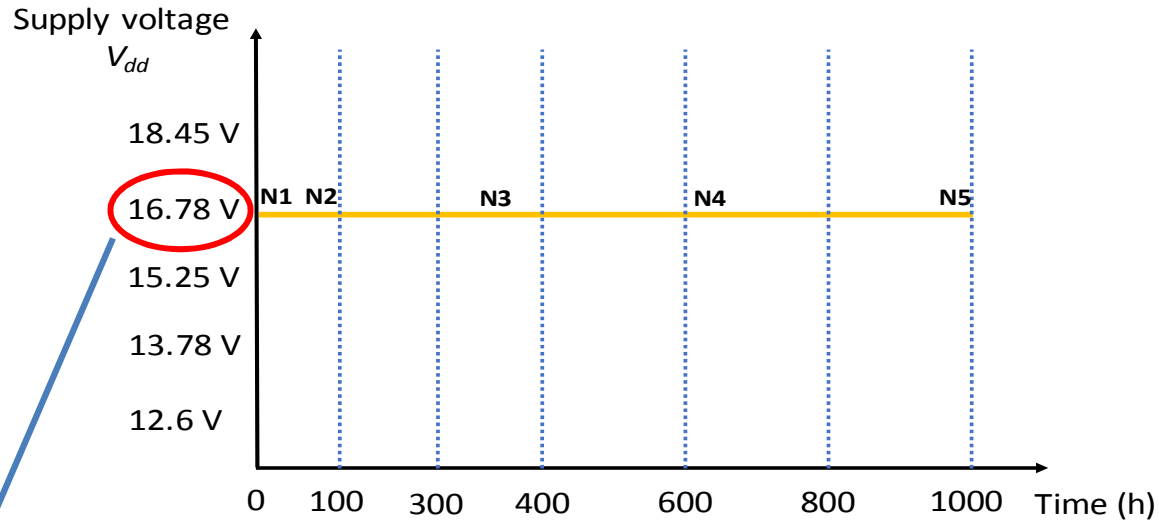

Electrical stress : level before failure in previous electrical step stress

$T = 100^{\circ}\text{C}$

Test duration : 1000h

Effect of ageing on immunity performances - Test 2

S-parameters (PDN)

Measurements at different aging time – polarized IC

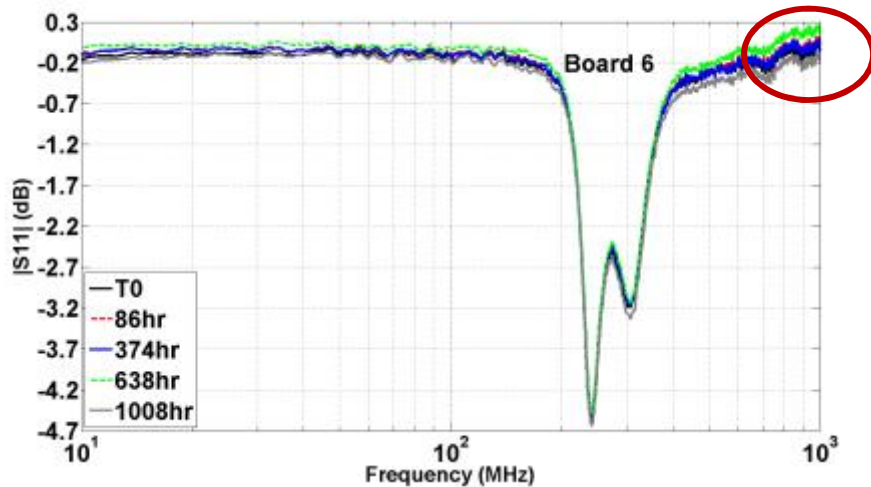

- Progressive slight evolution of $|S_{11}|$ with ageing time especially at “high frequency”



No need to be taken into account in the PDN model

Effect of ageing on immunity performances - Test 2

IB blocks

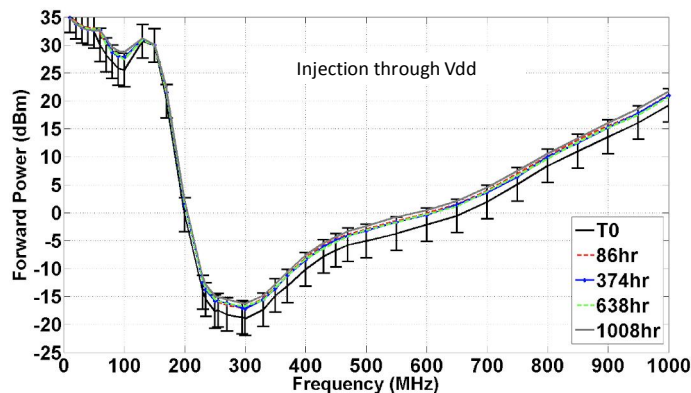

- very slight modification of the immunity behavior of the component during ageing

$$V_{out} = V_{ref} + C_{in}(f) * P_{forw},$$

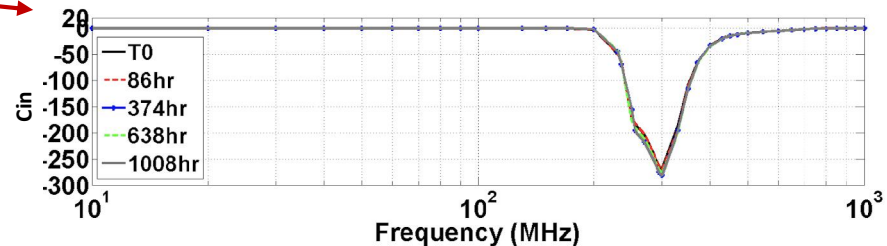
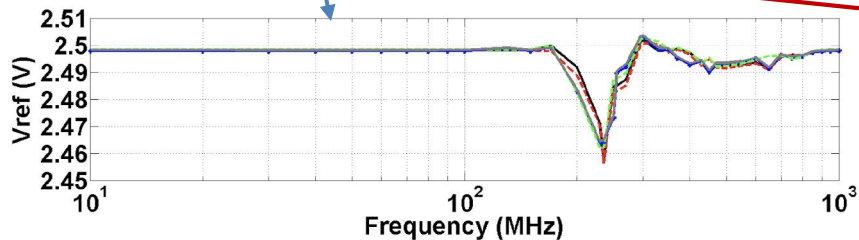

Easy improvement of ICIM-CI model : adding offset on V_{ref}

Conclusion

- IC Immunity before ageing
 - Decrease of the output voltage according injected power
 - ICIM-CI modeling
- Ageing phase :
 - Effect of electrical step stress and thermal storage
 - permanent modification of the output voltage
 - no modification of the intrinsic immunity characteristic
 - Effect of electrical stress and thermal storage
 - no modification of the immunity characteristic
- Behavioral immunity modeling taken into account ageing
 - Easy model improvement : modification of the output voltage as a function of the electrical step stress



Thank you for your attention