



HAL
open science

The Use of a Small Single Fuel Cell to Feed a 10H Superconducting Coil

Melika Hinaje, Stéphane Raël, Kévin Berger, Rafael-Antonio Linares-Lamus,
Jean Lévêque

► **To cite this version:**

Melika Hinaje, Stéphane Raël, Kévin Berger, Rafael-Antonio Linares-Lamus, Jean Lévêque. The Use of a Small Single Fuel Cell to Feed a 10H Superconducting Coil . IEEE Transactions on Applied Superconductivity, 2018. hal-01596630v1

HAL Id: hal-01596630

<https://hal.science/hal-01596630v1>

Submitted on 27 Sep 2017 (v1), last revised 28 Feb 2018 (v2)

HAL is a multi-disciplinary open access archive for the deposit and dissemination of scientific research documents, whether they are published or not. The documents may come from teaching and research institutions in France or abroad, or from public or private research centers.

L'archive ouverte pluridisciplinaire **HAL**, est destinée au dépôt et à la diffusion de documents scientifiques de niveau recherche, publiés ou non, émanant des établissements d'enseignement et de recherche français ou étrangers, des laboratoires publics ou privés.

The Use of a Small Single Fuel Cell to Feed a 10H Superconducting Coil

Melika Hinaje, Stéphane Raël, Kévin Berger, Rafael Linares, and Jean Lévêque

Abstract—In this paper, we propose to replace the usual dedicated electronic power supplies of superconducting coil, which are in most cases a huge volume and/or a low energy yield, by a 100 cm² single proton exchange membrane fuel cell (PEMFC). Indeed, fuel cells are electrochemical converters which can be considered as DC low voltage electrical source. Preliminary investigations led with a single proton exchange membrane fuel cell (PEMFC) could evidence the behavior as a DC current source, in which the current is directly controlled by the hydrogen flow rate. In a first step, we highlighted the feasibility by supplying a small superconducting coil, with an inductance value of 4 mH by means of a single PEMFC and proved that dedicated power source can be replaced by fuel cell. The second step is to feed a superconducting coil with higher inductance, 10 H, as presented in the present work.

Index Terms—power supply, proton exchange membrane fuel cell, superconducting coils.

I. INTRODUCTION

FUEL cells are electrochemical energy converters which allow transformation of the chemical energy of a fuel to electricity through oxido-reduction reaction. The voltage of an elementary cell is usually near 1 V in open circuit and around 0.6 V in nominal conditions of power generation. Fuel cells are then by essence low voltage sources, so that for most practical applications, power management is carried out by electronic converters, allowing in particular to rise the voltage to usual application levels.

In this paper, we propose and experiment a totally new fuel cell application that takes advantage of this low voltage level: the electrical supply for power superconducting coils. At present, such applications are dealt with specific electronic power supplies, exhibiting in most cases huge volume and weight, and/or a low energy yield. In this configuration, the single proton exchange membrane fuel cell (PEMFC) operates in or near short circuit conditions, i.e. far below the threshold recommended by the cell manufacturer ($V_{cell} < 0.6$ V). In previous works, we demonstrated that such particular and non-usual conditions were not detrimental for fuel cells, but moreover that they allow electrical behavior as a current source, in which the current is controlled by the hydrogen flow rate [1].

We tested successfully this way the current control of a short-circuited single fuel cell, then we experimented one of

Melika Hinaje, Stéphane Raël, Kévin Berger, Rafael Linares, and Jean Lévêque are with the Group of Research in Electrical Engineering of Nancy, University of Lorraine, Faculty of Sciences and Technologies, 54 506 Vandoeuvre-lès-Nancy, France (e-mail: name.surname@univ-lorraine.fr).

the target applications for such an operating mode, i.e. current supply of superconducting coils. Indeed, we tested the association of a 100 cm² single fuel cell and a small superconducting coil, with an inductance value of 4 mH [2]. Once more, the experiment was convincing, this is the reason why we decided to extend the study to a large superconducting coil, with an inductance value of several henrys.

To better grasp the problematic and the novelty of our work, which is the first of its kind in the world, we will first do a brief review of former results. Then, we will present the experimental setup, and associated results.

II. STATE OF THE ART

A. Fuel cell operating as a current source controlled by hydrogen flow rate

Usually, investigations, led on fuel cells, aim to maximize the delivered power at given operating condition, or in others words to get the highest voltage as possible for an imposed current from the load as shown in Fig. 1. For the purposes we aim, the challenge is not to improve the resulting voltage at a given operating point, but on the contrary to operate close to zero volt, i.e. in the limit diffusion area, which corresponds in electrical theory to an ideal current source. As depicted in Fig. 1, the current supplied by the fuel cell is then close or equal to the diffusion limit current, I_{set} , which is a linear function of hydrogen flow rate, according to Faraday's law:

$$I_{set} = \frac{2F}{60 * V^0} * dH_2 \quad (1)$$

where dH_2 is the hydrogen flow rate in nL/min, F is the Faraday's constant, and V^0 is the normal molar volume in L/mol.

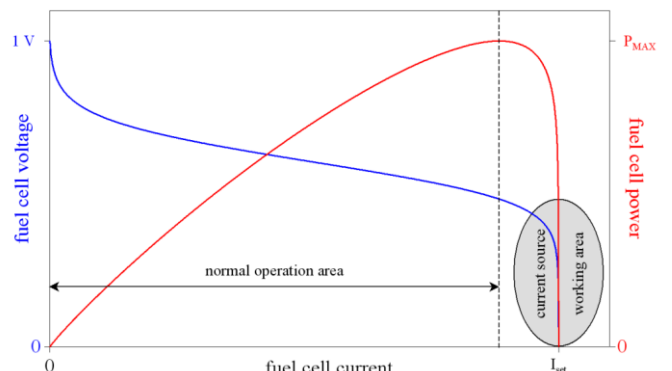

Fig. 1. Fuel cell typical polarization curve and power.

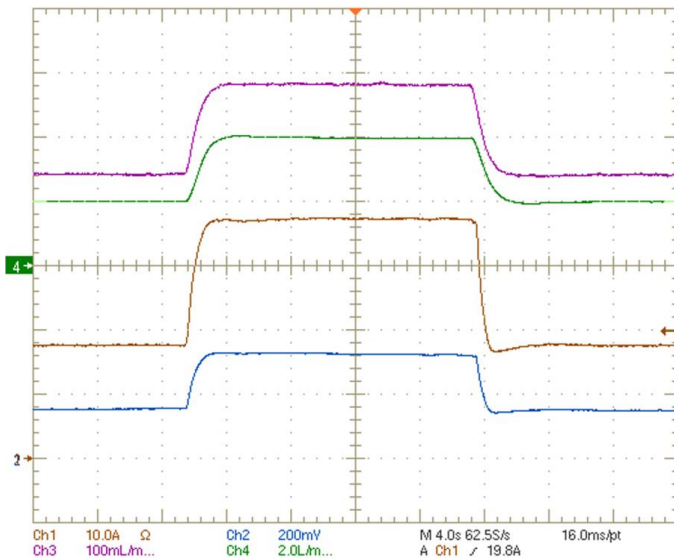

Fig. 2. Current controlled by hydrogen flow rate. Up and down current step of 20 A, $I_{set} = 18$ A to 38 A. Ch1. Fuel cell current, Ch2. Fuel cell voltage, Ch3. H_2 flow rate, Ch4. Air flow rate.

As a result, this particular working area enables an accurate current control through hydrogen flow rate. Other operating conditions, such as the cell temperature, the relative humidity of the reactants, and the over-stoichiometry in air supply, are also crucial, as far as they contribute to determine the potential range of the current source working area.

Fig. 2 presents some experimental results obtained when operating a single PEMFC as a current source. To this end, the single cell was short-circuited. The purple curve (Ch3 of the oscilloscope) represents time evolution of hydrogen flow rate, with a scale of 100 mL/min. Two steps are driven by means of the anode flow controller: the first from 140 mL/min to 280 mL/min, the second from 280 mL/min to 140 mL/min. Both theoretically correspond to a 20 A variation (increase for the first step of flow rate, decrease for the second) of the diffusion limit current I_{set} . On the red curve (Ch1 of the oscilloscope), one can observe that time evolution of fuel cell current is analog to the one of hydrogen flow rate. Moreover, steps of flow rate actually imply steps of fuel cell current, with the correct amplitude, i.e. 20 A (from 18 A to 38 A for the first step of flow rate, from 38 A to 18 A for the second). Fuel cell voltage (blue curve, Ch2 of the oscilloscope) is not exactly zero, this is due to the short-circuit resistance (approximately 8 m Ω). However, it is low enough for the considered current densities, to ensure the fuel cell operation as a current source.

At last, even if we showed that a current source operating mode was electrically possible and reliable for fuel cells, it remained to be demonstrated that such low voltage conditions were not detrimental for the cell components. This crucial point was investigated in LRGP laboratory (the chemical engineering laboratory from the University of Lorraine), by following the state-of-health of a 100 cm² single fuel cell, submitted to a short-circuit at 0.6 A/cm², set by the corresponding hydrogen flow rate [3]. After more than 2,000 hours operation, the delivered current was still around 98% of that corresponding to the injected hydrogen flow rate, and the features of cell were just a little affected, in comparison with usual operating

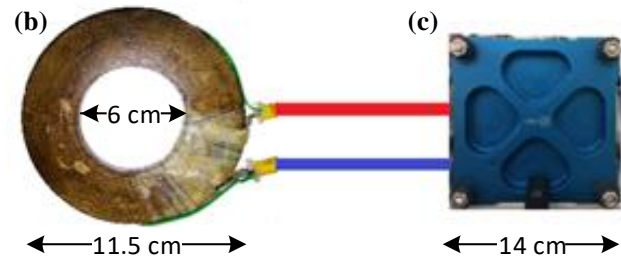
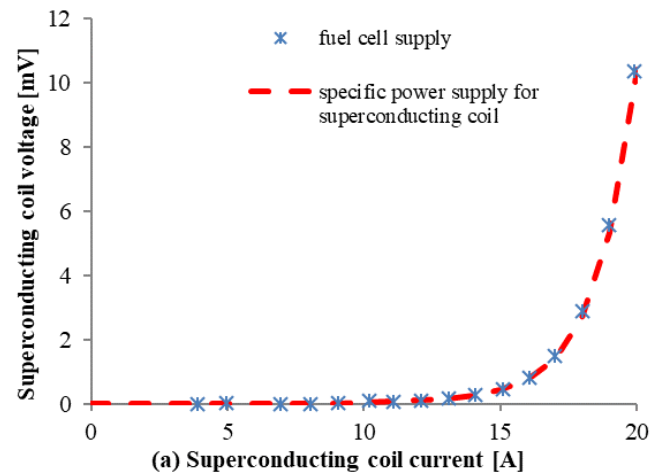

Fig. 3. V-I characteristic (a) of the 4 mH superconducting coil shown in (b) and fed by a single PEMFC of 100 cm² active area (c).

conditions. It has moreover to be underlined that hydrogen crossover was not affected at all.

Since the behavior of the single PEMFC as a controlled current source has been checked, the next step was to validate the interest of such an operating mode on an electrical load that needs to be fed by a low voltage DC current source (less than about 0.25 V). As our lab has strong expertise on superconductivity applications, it comes naturally to test this new application on superconducting coils.

B. Single fuel cell supplying a superconducting coil

Superconducting coils require a perfectly DC current [4], [5], and due to the nature of the superconducting wire, their voltages are virtually zero (about 1 μ V per wire centimeter, because of the superconducting character of the wire). It comes to use the potentialities of low voltage operation of fuel cells, especially in terms of control of the fuel cell current by means of hydrogen flow rate, as it was demonstrated above. For this purpose, after having proven that fuel cells can exhibit the electrical behavior of a regulated current source, as shown in Fig. 2, we carried out some preliminary tests reported in [2], with a 100 cm² single fuel cell feeding a small superconducting coil with an inductance value of 4 mH. These experimental tests revealed the potentialities of this technique. Indeed, as depicted in Fig. 3, the single fuel cell used as a current source shows exactly the same behavior than commercial power supplies especially designed for superconducting coils [6]–[11]. Moreover, we easily managed to supply the 4 mH superconducting coil up to 20 A, close to the coil critical current.

The next step in our objective, detailed in this article, consists in applying our supply principle to full-scale superconducting coils. For such loads, given the high value of inductance (e.g. 10 H, in the case we treat here), the challenge lies in controlling safely the coil current. First, the coil may induce negative voltage, critical for the fuel cell. Second, as demonstrated in [1], [12], reactant gases stored in the fuel cell feeding pipes have a great influence on the transient fuel cell electrical response. In our case (see Section IV), they can give rise to current overshoot and negative fuel cell voltage. In the following, we will define requirements needed for a safe and reliable operation, when supplying a full-scale superconducting coil with a single fuel cell.

III. EXPERIMENTAL SETUP

Fig. 4 shows pictures of the 10 H superconducting coil (outside the cryostat dedicated to cool it in Fig. 4(a), and inside the cryostat in Fig. 4(c)), and the 100 cm² single fuel cell used for the coil supply is shown in Fig. 4(b). What evidently strikes is the single PEMFC small size and weight (140 mm x 140 mm x 80 mm; 2kg) compared to the load to be supplied. Moreover, as it can be deduced from size and weight data given in Table I, the fuel cell solution for supplying a full scale superconducting coil allows a gain of more than 10 times in volume and weight, in comparison with usual dedicated superconductor power supplies. Some additional advantages can be cited for instance, in case of power supply breakdown, PEMFC supply needs only the replacement of parts that can be made on site by the operator. This usually takes only

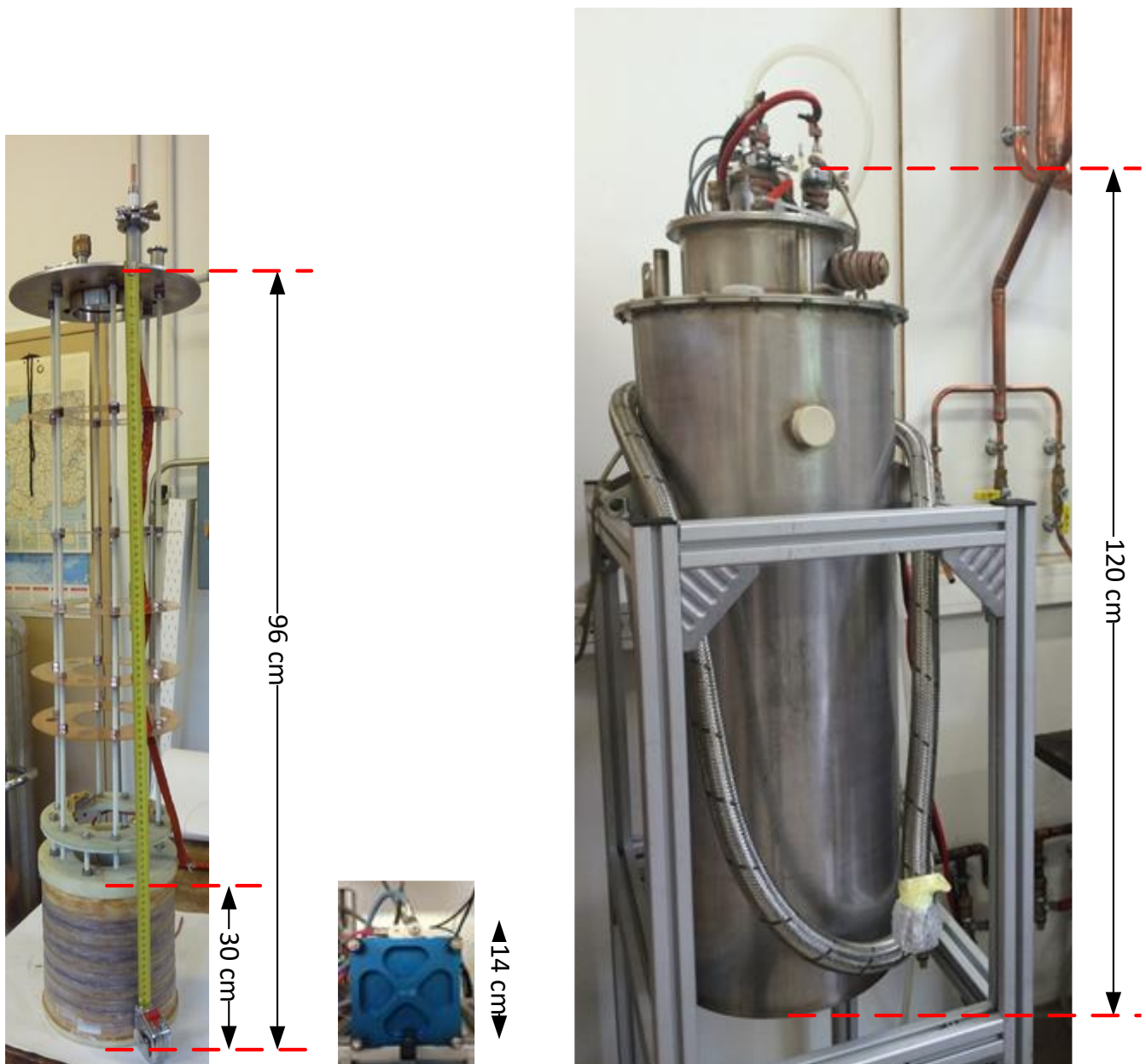

Fig. 4. Superconducting coil outside of cryostat (a), single PEMFC (b), and superconducting coil and cryostat system (c).

TABLE I
CONVENTIONAL SUPERCONDUCTING SUPPLIES

Model	AC input	Maximum current	Maximum output power	Weight	Size
American magnetics System 05100PS-430-601 [6]	200-240 VAC \pm 10% 50-60 Hz	100 A	500 VA	32 kg	318 mm (H), 533 mm (W), 610 mm (D)
American magnetics System 05200PS-430-601 [6]	200-240 VAC \pm 10% 50-60 Hz	200 A	1000 VA	75 kg	635 mm (H), 600 mm (W), 600 mm (D)
Cryomagnetics 4G 100 [7]	220-230VAC, 50-60 Hz, 16A max	100 A	1000 W	29 kg	483 mm (W), 133 mm (H), 533 mm (D)
Cryomagnetics 4G 200 [7]	220-230VAC, 50-60 Hz, 16A max	200 A	2000 W	43.2 kg	483 mm (W), 133 mm (H), 33 mm (D)
Lakeshore Model 625 [9]	100 to 240 VAC +6% -10%, 50-0 Hz	60 A	300 W	27.2 kg	483 mm (W), 178 mm (H), 520 mm (D)
Scientific magnetics Model SMC120-10 [10],	180-253 VAC; 50-60 Hz	120 A	1200 W	30 kg	483 mm (W), 223 mm (H) 450 mm (D)
Xantrex XFR 7.5-300 [11]	190-264VAC 47-63 Hz	300 A	2250 W	15 kg (+5kg of controller device)	483 mm (W), 88 mm (H), 533 mm (D)

several minutes and is less expensive than the repair procedure for a power supply dedicated superconductor, which implies to send it back to the manufacturer and the shipping related delays...

The electrical structure of our test bench is depicted in Fig. 5. To protect the system, for instance against changes of state of the superconducting coil, an emergency stop is achieved by means of a power MOS transistor. A high current device, rated current of 1 200 A was chosen, in order to introduce the lowest possible resistance, i.e. the on-state resistance of the chosen transistor is only about 1 m Ω . Moreover, a free-wheeling diode (FWD) is added, in order to ensure current continuity in the inductive coil, to protect the fuel cell against high reverse voltage, and optionally to dissipate coil energy if emergency stop is used. At last, note that the superconducting coil is included with a protection resistor of 1 Ω in our case.

IV. EXPERIMENTAL RESULTS

A. Start-up of the test bench

To start the superconducting coil supplying, the best way to proceed is to connect first the coil to the single fuel cell, then to supply "slowly" the single cell with reactant gases. The term "slowly" will be defined and quantified in Section IV.B. We choose hereafter to proceed another way, in order to put to the fore the unsafe phenomena, i.e current overshoot, negative fuel cell voltage previously mentioned (see end of Section II), which may occur if no precautions are taken when supplying a full-scale superconducting coil.

Fig. 6 shows experimental curves obtained when the coil is connected to the single cell, after having previously fed the cell with reactant gases. As it can be seen in Fig. 6(a), hydrogen flow rates is set to 140 mL/min, which corresponds to a target current (denoted I_{set} , in Fig. 1, and in Fig. 6(b)) of 20 A, according to (1). The cell cathode is overfed with dry air at a

rate of approximately 1 L/min, i.e. 3 times the rate required for such a current. Fig. 6(b) reports the time evolution of all application currents: target (black line), fuel cell (red line), coil (blue dash line), and freewheeling diode (orange line). First, one can obviously observe that the coil current is regulated to I_{set} in steady-state, i.e. to the value corresponding to the hydrogen flow rate. However in transient, as the cell was fed with reactant gases before connecting it to the coil, the start-up gives rise to a long period during which the cell is overfed with hydrogen. This induces a current overshoot, because of the fuel initially stored in the anode pipe. Then, current naturally decreases to its steady-state level. During this phase, the coil inductance opposes a negative voltage which is transmitted to the fuel cell, as it can be observed in Fig. 6(c). Here, one can notice the safety function of the freewheeling diode, which turns on see in Fig. 6(b), the short period during which the FWD is in conduction, involving a smooth difference between fuel cell current and coil current, and consequently limits the negative voltage applied to the fuel cell to a small value (about -0.7 V, or -0.4 V if a Schottky diode was used, instead of a bipolar diode).

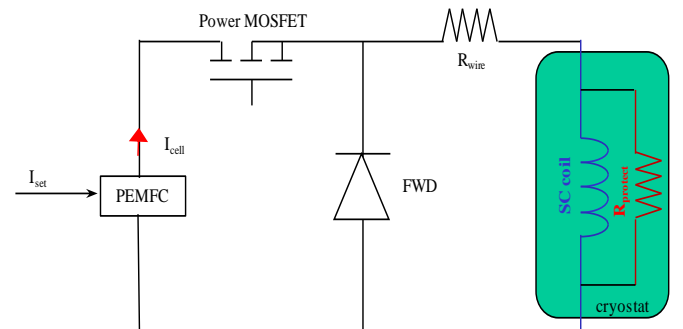

Fig. 5. Sketch of the association of superconducting coil to a single PEMFC. FWD is free-wheeling diode, $R_{protect}$ a shunt of 1 Ω in parallel with the coil and inside the cryostat, R_{wire} is the resistance corresponding to the wire, and the Power MOSFET is dedicated for disconnecting the coil from the PEMFC.

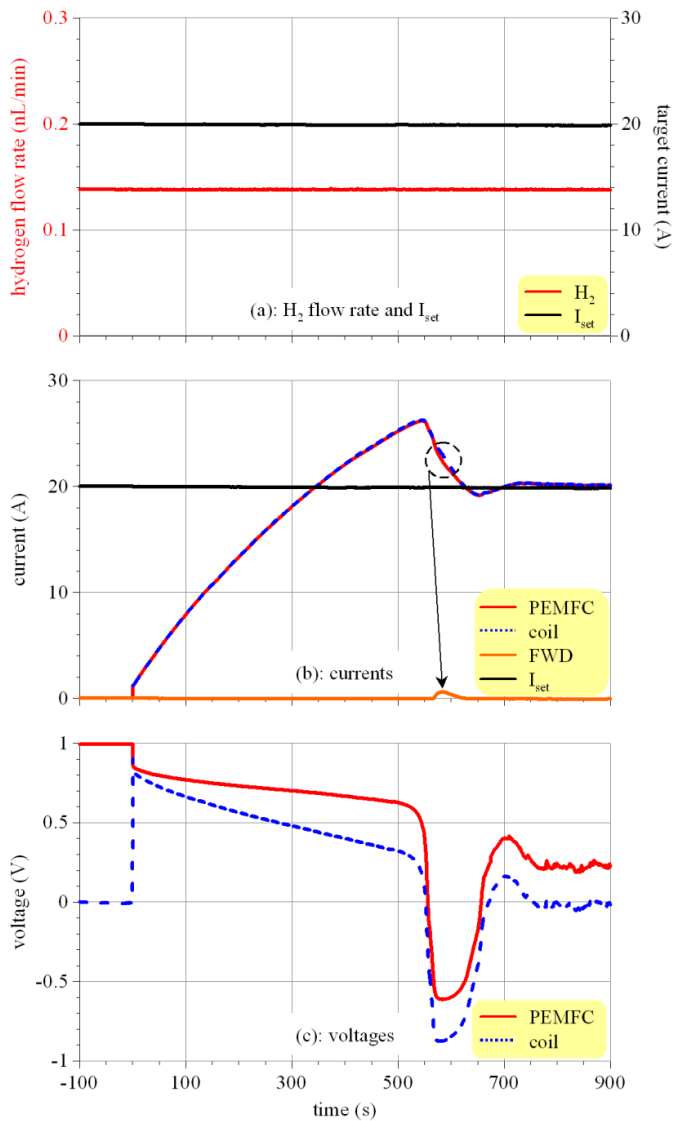

Fig. 6. Start-up with H₂ flow rate preset for $I_{set} = 20$ A (over-stoichiometry in air supply: 3). (a) H₂ flow rate and corresponding target current, (b) Application currents, (c) Fuel cell and coil voltages.

This first test highlights that the fuel cell and the superconducting coil have to be connected together before feeding the fuel cell with reactant gases. More generally, it shows that the slope of hydrogen flow rate increase has to be carefully chosen, so as to not exceed the set point which ensures current control through fuel flow. The next tests are achieved that way.

B. Superconducting coil supply

To control current by hydrogen flow rate, when supplying a superconducting coil by means of a single fuel cell, it is necessary to operate the cell in its current source working area in both transient and steady state. In other words, the aim is to get an instant equality between the fuel cell current, and the target current I_{set} i.e. the diffusion limit current derived from the hydrogen flow rate, according to (1). This means that the

fuel cell voltage must be kept at a low level that enables this kind of operating mode.

In steady state, this condition will be satisfied if the resistive voltage drop of the connection circuit (comprising, in our case, the power MOS transistor and wires between the fuel cell and the coil) is low. Consequently, the condition leads to define whether a maximum application current for a given circuit, or a maximum circuit resistance for a given rated current.

In transient state, during coil current increase, the coil induces an inductive voltage, $L di_{coil}/dt$, which is added to the circuit resistance voltage drop. This supplementary voltage must be low enough, in order to keep the fuel cell voltage at a level within the current source working area. This means that the hydrogen flow rate, and therefore the targetted current I_{set} , must be "slowly" increased, so as to obtain an effective current control in transient.

Consider, for example, an increase of coil current from 25 A to 35 A, as experimented in Fig. 7. In our experimental setup, the total circuit resistance is 11 m Ω , which will lead to a fuel cell voltage equal to 385 mV (i.e. 11 m $\Omega \times 35$ A) in the final steady state. If coil current is linearly increased in 1000 s, which corresponds to a transient inductance voltage of 100 mV (10 H \times 10 mA/s), fuel cell voltage will be lower than 485 mV all over the current increase. At a such current density which does not exceed 0.35 A.cm², this voltage level is low enough, so as to keep the fuel cell in its current source working area, then to ensure current control by means of hydrogen flow rate. Fig. 7 hereafter highlights the experimental proof of this theoretical result.

Fig. 7(a) shows time evolution of hydrogen flow rate (in red) and corresponding target current (in black). Air is fed under over-stoichiometric conditions. Hydrogen flow rate is linearly driven from 175 mL/min to 245 mL/min in 1000 s, which corresponds for the target current I_{set} to a linear increase from 25 A to 35 A. Fuel cell and superconducting coil electrical quantities (current, voltage) are plotted in Fig. 7(b) and Fig. 7(c), respectively. It can be obviously observed that fuel cell current properly follows the target current I_{set} , which means that current control by hydrogen flow rate is effective all over the transient, as well as in both steady states. As a result, the cell is working under unit hydrogen stoichiometry (no fuel excess), so that nearly no current overshoot is observed, avoiding that way negative fuel cell voltage.

Effective current control by hydrogen flow rate can also be achieved during current decrease, for example to gently stop the experiment, when switching off the emergency stop is not necessary. In this configuration, the transient inductance voltage induced by the variation of hydrogen flow rate, i.e. $L di_{set}/dt$, is negative, so that the fuel cell will operate in its current source working area (provided of course that this regime was previously in progress). However, the current decrease phase may result in a negative voltage operation of the fuel cell. This can be simply avoided by choosing, for the variation of hydrogen flow rate, a value for which the inductive term $L di_{set}/dt$ does not entirely compensate the circuit resistance voltage drop.

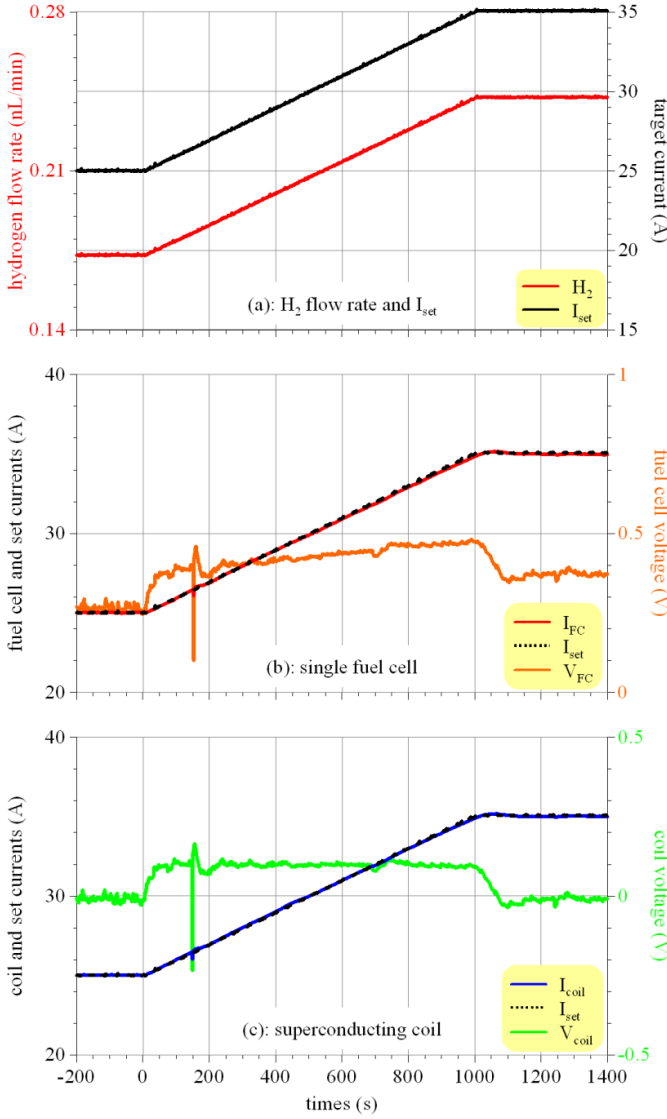

Fig. 7. Managing a coil current increase from 25 A to 35 A in 1000 s by controlling H_2 flow rate. (a) H_2 flow rate and corresponding target current, (b) Fuel cell current compared with target current, fuel cell voltage, (c) Coil current compared with target current and coil voltage.

The experimental test treated in Fig. 8 (which is structured as in Fig. 7) is a linear coil current decrease, from 35 A to 25 A. The circuit resistance voltage drop has a minimum value of 275 mV (i.e. $11\text{ m}\Omega \times 25\text{ A}$), which theoretically allows current slopes up to -27.5 mA/s . As the test was carried out with a slope of -20 mA/s , it can be observed in Fig. 8(b) that the fuel cell effectively operates in current source mode, i.e. fuel cell current is equal to target current, with a positive voltage all over the transient.

V. CONCLUSION

Some previous experiments highlight the fuel cell operation as a controlled current source [1]. This unusual use of PEMFC pushed us to extend the study to practical case such as superconducting coil supply. This application was chosen because superconducting coils need very low voltage and high DC current supply and do not stand current ripples. Moreover, as it

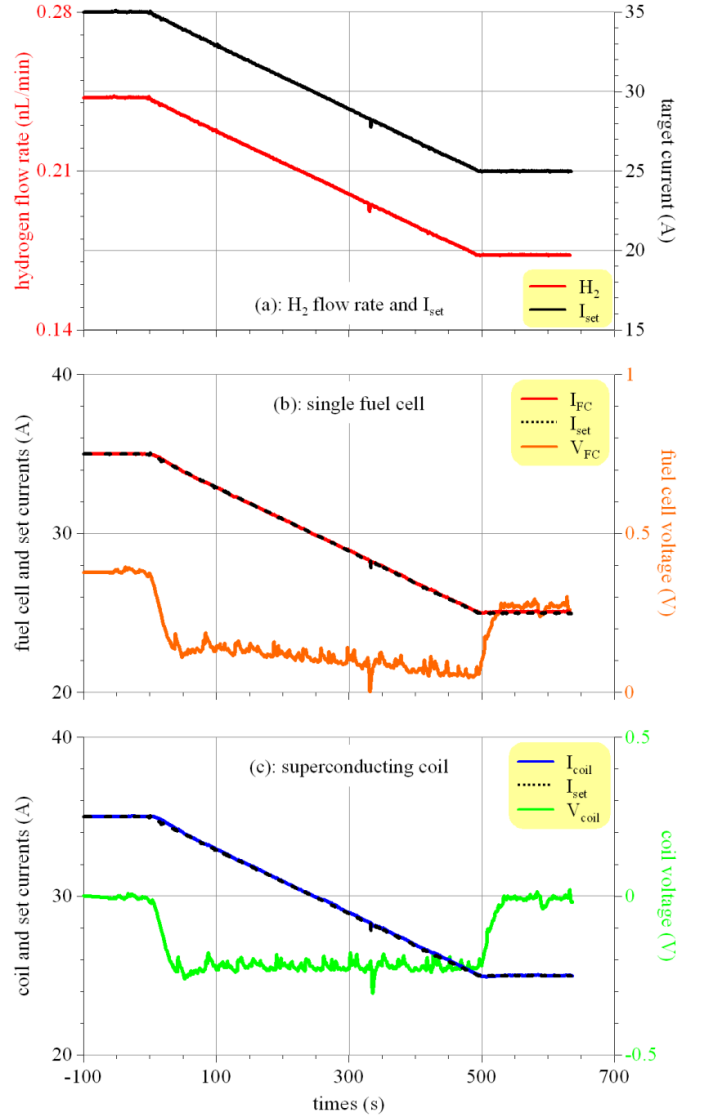

Fig. 8. Managing a coil current decrease from 35 A to 25 A in 500 s by controlling H_2 flow rate. (a) H_2 flow rate and corresponding target current, (b) Fuel cell current compared with target current, fuel cell voltage, (c) Coil current compared with target current and coil voltage.

has been already written GREEN lab has a strong expertise in this field for many decades and senses a promising future in this type of application that remains, for the moment a niche application as the beginning of superconductivity before their democratization in area of health thanks to Nuclear Magnetic Resonance (NMR).

This paper has proven the feasibility of feeding a large low temperature superconducting coil with a simple single PEMFC. For higher power coils, the fuel cell current can be increased either by increasing the active area of the single fuel cell, or by connecting in parallel a sufficient number of single fuel cells to reach the required current. To speed up the current increase, we should put in series additional cells to the PEMFC. In this case, some cells could behave differently from the others and their voltage could become negative, it still has to be checked. Such operation of fuel cell is still new and a lot of studies, in different scientific area, remain to be done.

ACKNOWLEDGMENT

We would like to acknowledge the cryogenic joint service of the Jean Lamour Institute (IJL), and more especially Thomas Hauet for allowing us to carry out these experiments, and Luc Moreau for his help during experimental tests. We are also grateful to our technician Isabelle Schwenker for helping us to set up the test bench.

REFERENCES

- [1] M. Hinaje, S. Raël, J.-P. Caron, and B. Davat, "An innovating application of PEM fuel cell: Current source controlled by hydrogen supply," *Int. J. Hydrog. Energy*, vol. 37, no. 17, pp. 12481–12488, 2012.
- [2] M. Hinaje, K. Berger, J. Lévêque, and B. Davat, "Superconducting coil fed by PEM fuel cell," *Int. J. Hydrog. Energy*, vol. 38, no. 16, pp. 6773–6779, May 2013.
- [3] C. Bonnet *et al.*, "Can PEM Fuel Cells Experience Appreciable Degradation at Short Circuit?," *Fuel Cells*, vol. 17, no. 2, pp. 157–165, 2017.
- [4] N. Nanato, Y. Tsumiyama, S. B. Kim, S. Murase, K.-C. Seong, and H.-J. Kim, "Development of quench protection system for HTS coils by active power method," *Phys. C Supercond. Its Appl.*, vol. 463, pp. 1281–1284, 2007.
- [5] K. Takeuchi *et al.*, "Fundamental studies for the application of quench protection systems based on an active power method for cryocooled LTS coils," *Cryogenics*, vol. 48, no. 3, pp. 148–153, 2008.
- [6] "American Magnetics Inc." [Online]. Available: <http://www.americanmagnetics.com/index.php>. [Accessed: 06-Oct-2016].
- [7] "Model 4G Bipolar Superconducting Magnet Power Supply," *Cryomagnetics, inc.*, 06-Oct-2016. [Online]. Available: <http://www.cryomagnetics.com/products/model-4g-bipolar-power-supplies-superconducting-magnets/>. [Accessed: 06-Oct-2016].
- [8] "Series NTS - FuG Elektronik GmbH," 06-Oct-2016. [Online]. Available: <http://www.fug-elektronik.de/en/products/superconductor/nts.html#devices>. [Accessed: 06-Oct-2016].
- [9] "Model 625 | Overview | Lake Shore Cryotronics, Inc.," 05-Oct-2016. [Online]. Available: <http://www.lakeshore.com/products/superconducting-magnet-power-supplies/model-625/pages/Overview.aspx>. [Accessed: 05-Oct-2016].
- [10] "Scientific Magnetics," 05-Oct-2016. [Online]. Available: <http://www.scientificmagnetics.co.uk/pdf/data-sheets/web-DS-superconducting-magnet-power-supply.pdf>. [Accessed: 05-Oct-2016].
- [11] "AMETEK Programmable Power: DC Power Supplies & AC Power Sources," 15-Sep-2016. [Online]. Available: http://www.programmablepower.com/dc-power-supply/XFR/downloads/XFR2-8_Operation_Manual_D_TM-F2OP-C1XN-01.pdf. [Accessed: 15-Sep-2016].
- [12] S. Kim, S. Shimpalee, and J. W. Van Zee, "The effect of reservoirs and fuel dilution on the dynamic behavior of a PEMFC," *J. Power Sources*, vol. 137, no. 1, pp. 43–52, 2004.