



HAL
open science

Wind Turbine Bearing fault detected with IAS combined with Harmonic Product Spectrum

André Hugo, Khelf Ilyes, Quentin Leclere

► **To cite this version:**

André Hugo, Khelf Ilyes, Quentin Leclere. Wind Turbine Bearing fault detected with IAS combined with Harmonic Product Spectrum. COMADEM 2017, Jul 2017, Preston, United Kingdom. hal-01595841

HAL Id: hal-01595841

<https://hal.science/hal-01595841v1>

Submitted on 27 Sep 2017

HAL is a multi-disciplinary open access archive for the deposit and dissemination of scientific research documents, whether they are published or not. The documents may come from teaching and research institutions in France or abroad, or from public or private research centers.

L'archive ouverte pluridisciplinaire **HAL**, est destinée au dépôt et à la diffusion de documents scientifiques de niveau recherche, publiés ou non, émanant des établissements d'enseignement et de recherche français ou étrangers, des laboratoires publics ou privés.

Wind Turbine Bearing fault detected with IAS combined with Harmonic Product Spectrum

André Hugo¹ *, Khelf Ilyes^{2,4}, and Leclère Quentin³

¹ Univ Lyon, UJM Saint Etienne, LASPI, EA 3059, F-42334, IUT de Roanne, France

² Univ Lyon, CNRS INSA-Lyon, LaMCoS UMR5259, F-69621, Villeurbanne,

³ Univ Lyon, INSA-Lyon, LVA EA677, F-69621, Villeurbanne, France

⁴ ENGIE GREEN, 2 place Samuel de Champlain, 92400 COURBEVOIE

ABSTRACT

A few years ago, Instantaneous Angular Speed (IAS) signal analysis has been proven able to detect natural bearing faults. Moreover, it has been applied on a 2MW wind turbine shaft line and proven able to detect low speed shaft unbalance using an encoder located on the high speed shaft turbine generator. This paper will show that a generator bearing fault can also be monitored using an encoder located on the low speed shaft. This step forward is made difficult by the lack of energy in the bearing fault speed fluctuation amongst the multitude of noisy phenomena, an alternative technique is proposed in this paper to extract dry impacts components from IAS spectrum. Harmonic Product Spectrum has originally been proposed in the sixties to detect fundamental frequency in a noisy signal. Still in use in the domain of speech signal processing, this method eases a precise voice pitch tracking. This paper proposes a revision of HPS to IAS analysis (and more generally to vibration monitoring), and a peculiar adaptation to look for inner ring modulated defects. The efficiency of the technique will be finally shown on real measurements issued from a 2MW wind turbine generator bearing fault.

Keywords: Instantaneous Angular Speed, Harmonic Product Spectrum, Bearing Fault, Rotating Machine Monitoring.

Corresponding author: Hugo ANDRE (email: hugo.andre@univ-st-etienne.fr)

1. INTRODUCTION

A few years ago, Instantaneous Angular Speed (IAS) signal analysis has been proven able to detect natural bearing faults [1]. This major experimental demonstration shows that mechanical faults can be detected through the reading of the torsional shaft movement rather than the transverse vibration of the equipment housing. Amongst the different technics that can be used to get IAS signal, Elapse Time seems to bring the best results and is under consideration in this paper. This acquisition method introduces specific limitations which have recently been detailed [2] and which mainly account for the difficulty to use classical vibration signal processing tools. For instance, within many methods that have been developed to improve bearing fault detection, the most favoured one is probably the envelope spectrum analysis of the vibration signal filtered on a conveniently chosen frequency band. However, the adaptation of this technique to Instantaneous Angular Speed (IAS) signals is not straightforward, since neither the impact nor the structural response reach the quantification threshold obtained with current acquisition systems.

This paper proposes an alternative technique to extract dry impacts components from IAS spectrum.

Originally proposed in 1968 by M.R Schroeder [3] and soon after democratized by Noll [4], Harmonic Product Spectrum is a method derived from Cepstrum analysis and used to detect fundamental frequency in a noisy signal. In the domain of speech signal processing, this methods eases a precise voice pitch tracking, which fundamental frequency can be mixed with the noise if not pointed out by its higher harmonics. This paper proposes a revision of HPS to IAS analysis (based on elapse time acquisition technique), and a peculiar adaptation to look for inner ring modulated defects. The efficiency of the technique will be finally shown on real measurements issued from a wind turbine generator bearing fault.

2. PROCESSING TOOLS

2.1. Description of HPS

Harmonic Product Spectrum is a tool dedicated to reveal the fundamental frequency of a harmonic set mixed with noise. The intuitive reasoning for the method is that the peach peaks in the log spectrum add coherently while the other portions of the log spectrum are uncorrelated and add non coherently. The frequency compression results in a sharper final peak as depicted in Figure 1. This figure, along with section, is largely inspired from the original paper which proposed HPS for the first time [4]. The antilog version of this schematization is the Harmonic Product Spectrum, and is simply defined such as:

$$\pi(\omega) = \prod_{k=1}^K X(k\omega)$$

With K the number of harmonics taken into account and $X(\omega)$ is the amplitude spectrum of the time signal. Therefore, the HPS is a function of the frequency and its unit is the original spectrum unit power K .

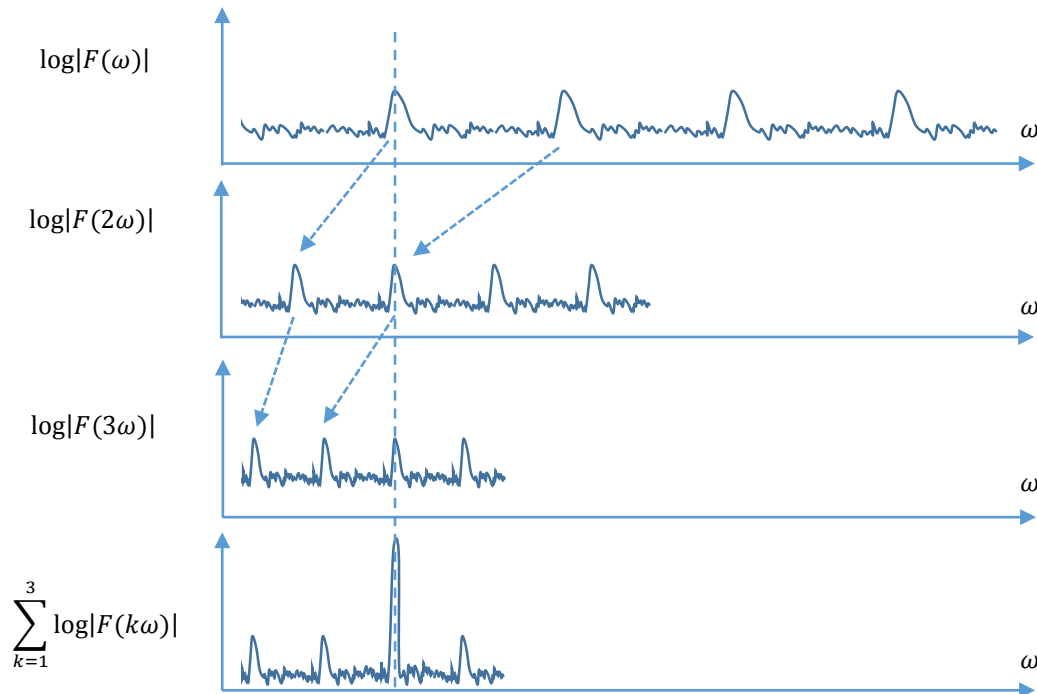

Figure 1 Development of the Harmonic Product Spectrum as the antilogarithm of the sum of harmonically compressed log spectra.

2.2. Application to rotating machinery

The main difference between speech analysis and rotating machinery monitoring is that the user is not only looking to locate the harmonic set frequency, but also to apprehend its amplitude in order to estimate a fault severity. Regarding this peculiarity, the fact that HPS unit is the original spectrum unit power K might pose a problem. A first proposal to tackle this issue is to present the HPS as a probability function, such as:

$$\pi(\omega) = \prod_{k=1}^K \frac{X(k\omega)}{\int_0^{f_{max}/K} X(k\omega) d\omega}$$

This slight modification transform the original HPS in a probability function without unit that can be interpreted as the chance for a frequency to correspond to the fundamental frequency of the harmonic set. Still, several difficulties are to be tackled:

1. In case of bearing monitoring, the healthy mode is not supposed to induce a harmonic set in the signal. This will be discussed in the end of the paper.
2. Rotating machinery signals are never populated with only one harmonic set. The more harmonic sets in the signal, the lower the probability will be. It appears therefore necessary to limit the frequency span of interest to a frequency band $[f_1; f_2]$ where no other harmonic set is expected:

$$\pi(\omega) = \prod_{k=1}^K \frac{X(k\omega)}{\int_{f_1}^{f_2} X(k\omega) d\omega}$$

- Several defect modes are not only a succession of harmonics, they are also modulated by a kinematic frequency which often corresponds to the shaft frequency carrying the defect. This will be solved in the next section.

2.3. Modulated Harmonic Spectrum

The formulation proposed by Noll could be slightly modified to profit from lateral bands induced by modulations such as shaft modulation or encoder geometric faults. For example, inner bearing fault are expected to be shaft modulated since the speed fluctuation they induce on the shaft depend on the load transmitted by the rolling element passing through the defect. Although this was already explained by [6] concerning vibration monitoring with a simple phenomenological model, academics are currently working on justifying a similar behaviour with IAS using a proper and brand new mechanical model [7]. In this work, modulation effect are considered by adding a preliminary step where the original spectrum is multiplied by shifted spectrum similarly to the HPS reasoning, modulated peaks will add coherently on the carrying frequency. The completed development is presented in Figure 2 in its log version, in the event that only one side band and three harmonics are considered. The authors propose to call its antilog version the Modulated Harmonic Spectrum (MHPS) and to define it such as:

$$\pi(\omega) = \prod_{k=1}^K \prod_{i=-M}^M |X(k\omega + i\omega_c)|$$

Where M is the number of side bands considered, and ω_c is the modulating frequency. The latter corresponds to the carrying shaft frequency in the case of inner ring fault.

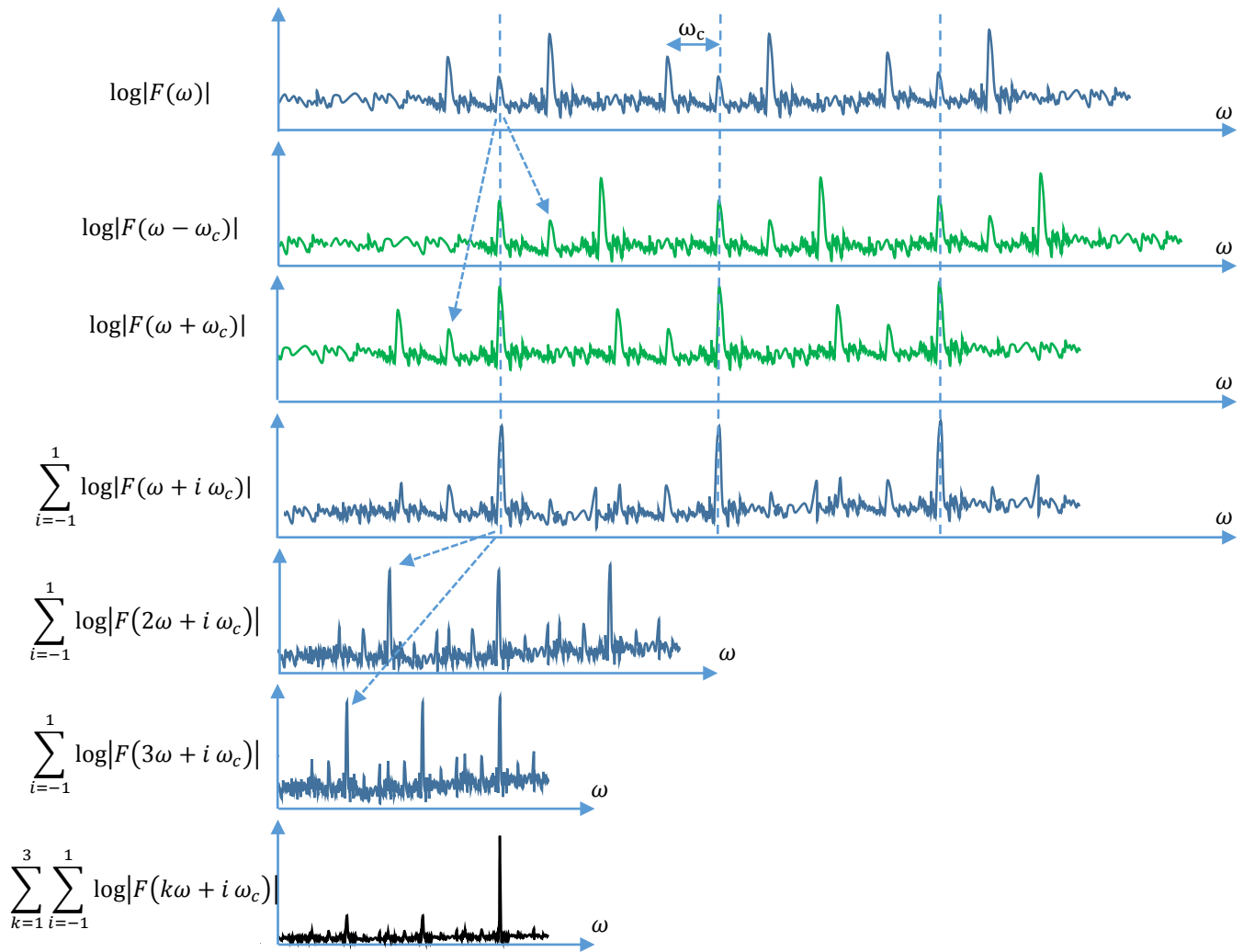

Figure 2 Development of the Modulated Harmonic Product Spectrum as the antilogarithm of the sum of harmonically compressed log spectra which has been demodulated.

3. MATERIEL AND METHODS

3.1. Instantaneous angular speed

Instantaneous Angular Speed (IAS) has recently appeared as an original and promising tool to monitor mechanical parts of rotating machines. Mechanisms running under non stationary conditions, such as wind turbine, are especially suited for this method since the issued signal is intrinsically sampled in the angular domain. Readers interested by the acquisition method can refer to [2]. Measurements have been obtained with the Elapse Time method, on a 20480 pulses per revolution magnetic encoder sampled with a 120MHz counter clock. The aim of this paper is not to present IAS monitoring, especially since HPS might bring interesting results on classical vibration measurements. However, the fact that Elapse Time technique yields an angular sampled signal is important since it helps harmonics components of cyclo-stationary phenomenon to be concentrated in one frequency channel.

3.2. Wind turbine bearing defect

A long term study is being carried over a MM82 wind turbine to qualify the ability of this monitoring system. The wind turbine set-up is presented in Figure 1 for the reader to realize the easiness of the involved instrumentation in regards with the kinematic complexity of the turbine line shafting. The IAS signal can be computed from the generator optical encoder, which is a high quality incremental encoder used by the converter to correctly synchronize the asynchronous generator; but also from a lower quality magnetic encoder, installed in retrofit operation on the low speed shaft directly carrying the rotor hub. It has been decided to equip the low speed shaft since the most expensive shaft line elements are cinematically and physically closer from it. The generator encoder has already been shown able to estimate the amplitude of speed fluctuation induced by a low speed shaft unbalance [5], and as a collateral benefit, this paper will check that the low speed shaft encoder is able to estimate speed fluctuation issued from a generator bearing. Originally, the acquisition card, FPGA type, is embedded in an industrial PC directly installed in the nacelle. The encoder is settled at the rear of the generator, coupled itself to the speed increaser gearing through a drive shaft coupling. The speed transmission is made of one star epicyclical gear train and one parallel stage mounted in serial configuration to obtain a global speed ratio approximately equal to 105.

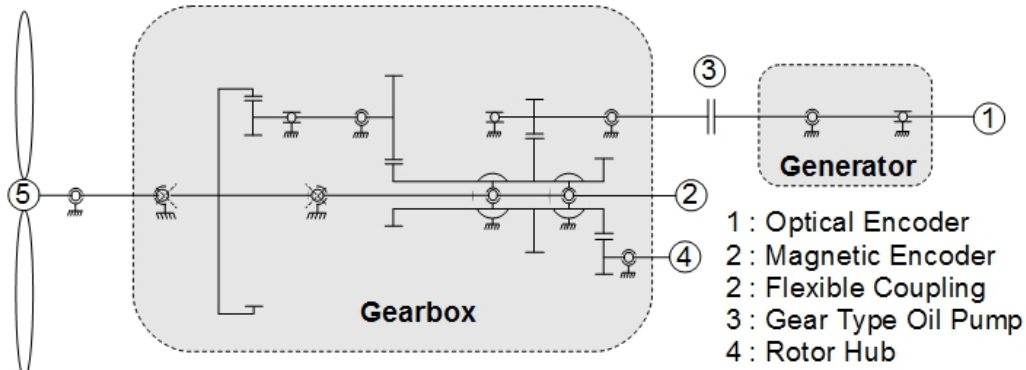

Figure 3: Kinematic Scheme of the wind turbine set-up

One of the two deep groove ball bearings in the generator experienced a double fault during the measurement campaign. The same bearing experienced, in the meantime, an inner ring and an outer ring defect: small spall (1cm²) on the outer ring and even smaller (20mm²) on the inner ring. Cyclic frequency of interest are successively defined here under in terms of events per high speed shaft revolution and events per low speed shaft revolution. Once the signal is sampled in the angular domain, bearing characteristic frequencies do not depend on the speed anymore but only on the reference shaft, ie. The shaft where the encoder is installed.

$$\begin{aligned}
 f_{BPFI} &= 4.81 (hss)^{-1} = 507 (lss)^{-1} \\
 f_{BPFI} &= 3.19 (hss)^{-1} = 336 (lss)^{-1} \\
 f_c &= 1 (hss)^{-1} = 105,5 (lss)^{-1}
 \end{aligned}$$



Figure 4: inner ring defect (on the left) and outer ring defect (on the right) of the generator front bearing.

4. RESULTS

4.1. State of the art results

Those defects were both efficiently detected using the optical encoder installed at the back of the generator, leading to an early stage replacement: it was not necessary for the operator to limit the maximal power of the turbine generator until the spare bearing replacement. The amplitude spectrum obtained with this sensor showed strong emergence on both BPFO and BPF1 of the corresponding bearing. The processing techniques used to detect the faults using this very close optical encoder do not hide any peculiar difficulties, and can be found in [5]. This allows us to precisely estimate the actual characteristic frequency of the defect, and take this information into account in the rest of the analysis. This difficulty will be mentioned in the discussion section.

For the sake of conciseness, this paper will focus on the IAS obtained from the low speed shaft magnetic encoder which is 5 meters, 3 gear trains and one mechanical coupling away from the defective generator bearing. It is important to precise that the fuse coupling between the generator and the gearbox is soft in flexion but rigid in torsion. However, as it can be seen on the low speed shaft IAS spectrum focused on bearing characteristic frequencies, defects do not clearly exhibit the defect. BPF1, in particular, will reveal itself if we take focus the same spectrum around some of its harmonics and high speed shaft modulated combs.

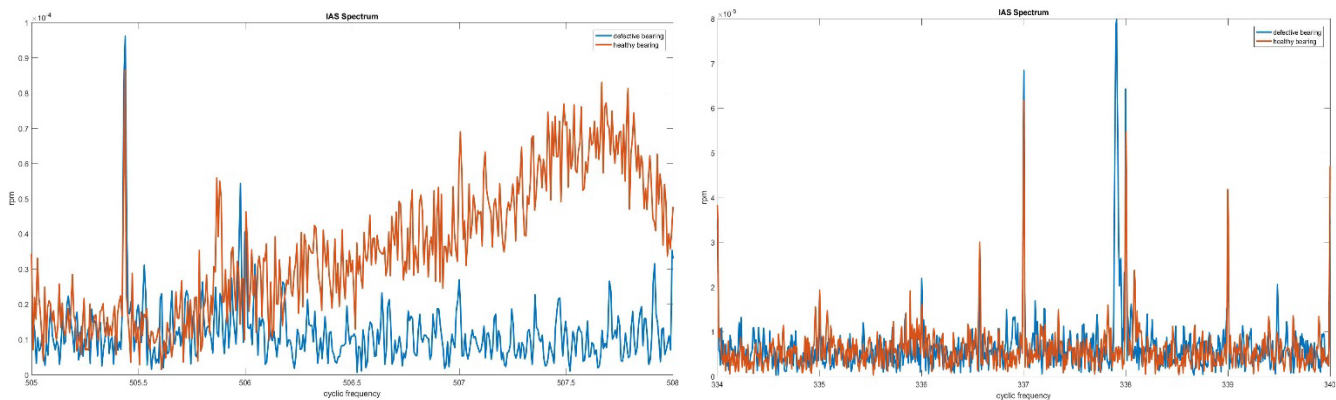

Figure 5: IAS Spectrum focused around BPF1 (characteristic cyclic frequency) on left, and on BPFO on right. Red spectrum is healthy bearing, when blue is defective. Cyclic frequency span

4.2. Harmonic Product Spectrum

Harmonic Product Spectrum takes into account harmonics only. Therefore, its ability to detect bearing fault is expected to work better with outer ring faults than inner ring ones. Figure 7 simultaneously shows HPS for defective and healthy signals. 4

harmonics are taken into account ($K = 4$) and the frequency band of interest is $2(lss)^{-1}$ wide: $[f_1; f_2] = [337; 339]$. This means the ordinate axis stands for the probability of each cyclic frequency channel in the interval $[f_1; f_2]$ to host the fundamental frequency of a harmonic set. As a result, a middle scoring peak ($< 40\%$) is seen for $f = 337.89 (lss)^{-1}$ on the defective signal, while a small peak emerges on the healthy signal for $f \sim 338.1 (lss)^{-1}$. Middle scoring since the defect does not reach 40% mass in the interval $[f_1; f_2]$.

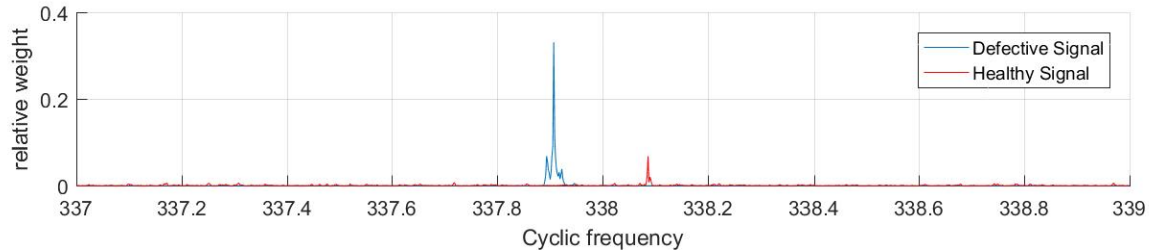

Figure 6: HPT 4 BPFO

It is clear that the arbitrary choice of $[f_1; f_2]$ presents an issue, especially since the characteristic frequency, which is not precisely known a priori, could be out of this small cyclic frequency span.

To deepen this problem, Figure 8 presents the gathered results obtained when several HPS are computed. The frequency span is the only varying parameter, and will be successively be shifted from 2 to 22 step by step (one step is $0.2 (lss)^{-1}$). The upper plot present the most probable characteristic frequency for each HPS, while the bottom plot present the probability of this “max frequency”. On the defective signal, the max frequency does not move from its first estimation, which happen to be the good one. On the contrary, the healthy signal reveals successively different frequencies ($338.1 (lss)^{-1}$ when $\Delta f \in [2; 3]$, $340 (lss)^{-1}$ when $\Delta f \in [3; 6.5]$, $341 (lss)^{-1}$ when $\Delta f \in [7; 16]$,...).

Moreover, in the case of the defective signal only, the probability associated to the most favoured frequency does not decrease noticeably along with the frequency span. This means that no other frequency channel appears within the extended interval able to compete with the BPFO cyclic frequency. On the contrary, the probability curve of the healthy signal is notably decreasing in magnitude, in a piecewise manner since every new local max introduces a small step increase of probability.

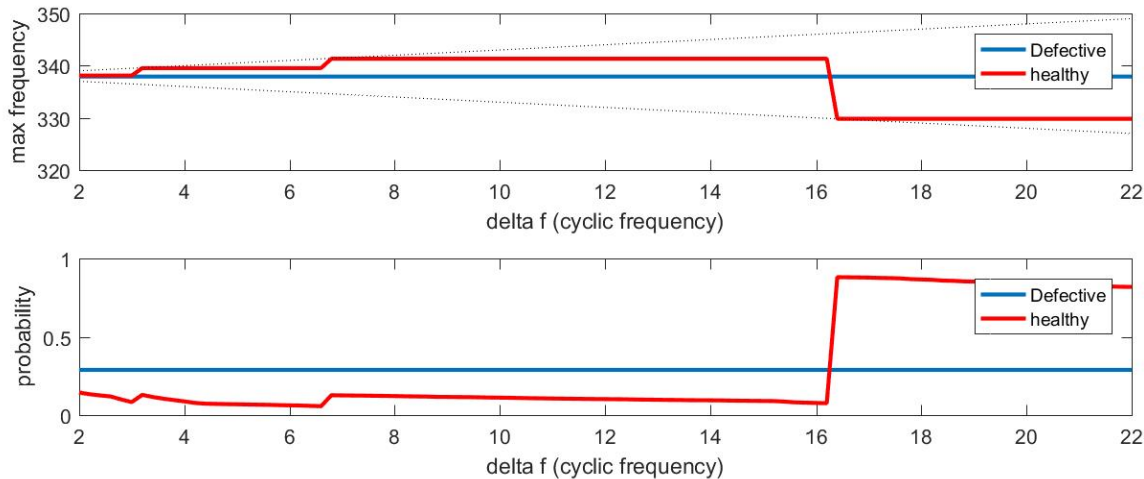

Figure 7: HPS local maxima depending on the frequency band of interest bandwidth. Top figure: frequency of the local maximum. Bottom figure: probability / relative weight of the local maximum. HPS computed with 8 harmo ($K=8$) and focused around **BPFO**.

Figure 9 present the same result but focused on **BPFI** frequency. The frequency identified by the HPS when $\Delta f \in [2; 4.5]$, is 506.84 and corresponds to the characteristic frequency observed from the high speed shaft encoder. However, this frequency is quickly overtaken by parasite phenomena, as soon as the frequency interval of interest is greater than $4.5(lss)^{-1}$.

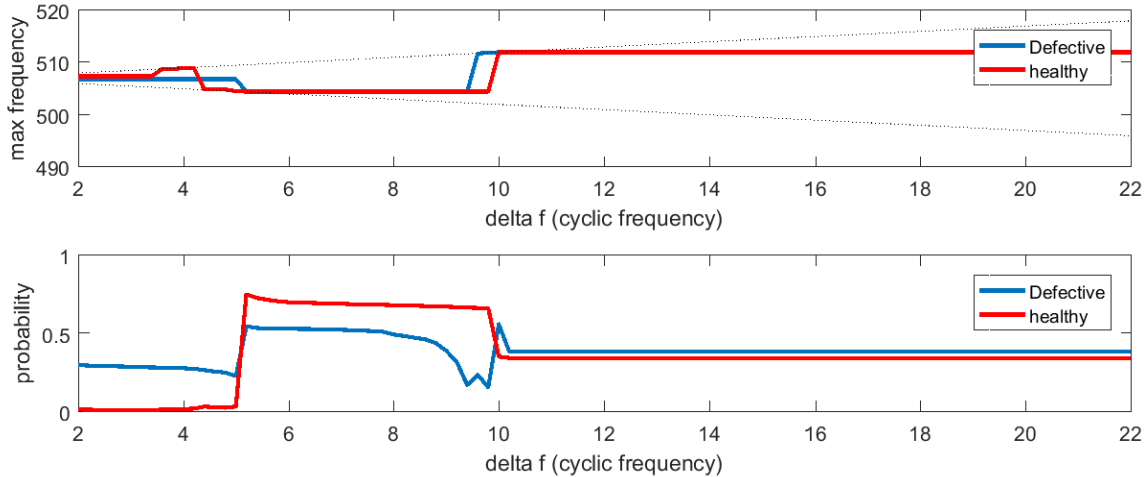

Figure 8: HPS local maxima depending on the frequency band of interest bandwidth. Top figure: frequency of the local maximum. Bottom figure: probability / relative weight of the local maximum. HPS computed with 8 harmo (K=8) and focused around **BPFI**.

4.3.MHPT

Figure 10 finally present the results for the inner ring defect obtained with MHPS in a similar manner. The same frequency channel $f = 506.84(lss)^{-1}$ is strongly identified ($\sim 100\%$!) by this improve method and is not exceeded until the frequency band of interest is polluted by $f = 512(lss)^{-1}$. This annoying cyclic frequency corresponds to the interpolation frequency of the encoder, which is extremely energetic since this is a magnetic encoder. This problem has already been detailed in the literature, and could have been avoided by a proper filtering but has been kept to illustrate the limit of the proposed approach. If the parasite phenomena are not removed prior to HPS or MHPS processing, the expert is exposed to such a pollution. However, MHPS brings a clear improvement regarding modulated fault.

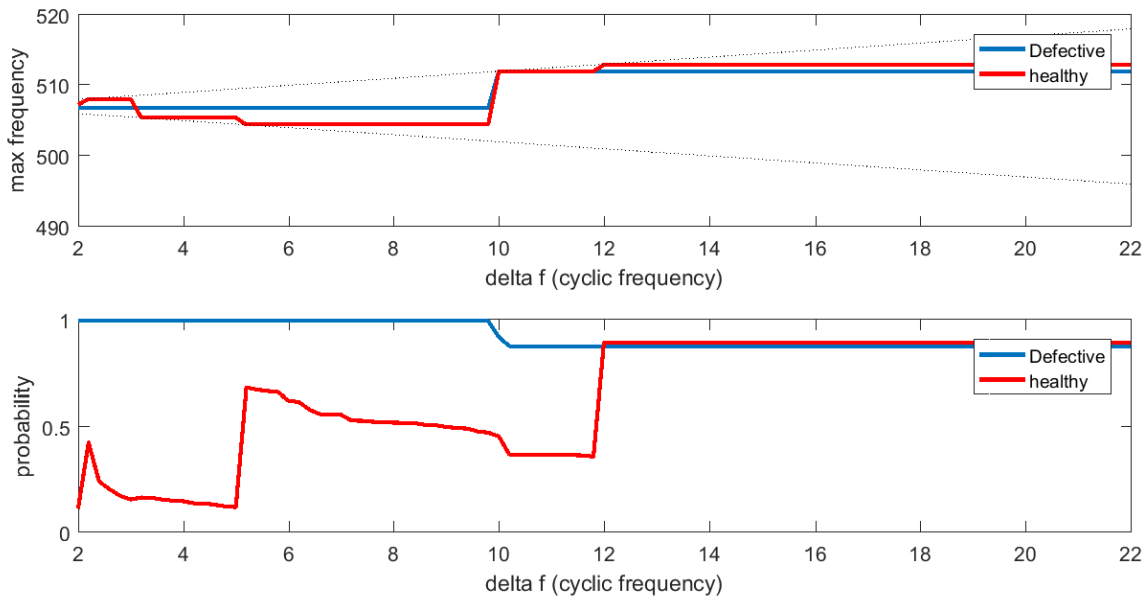

Figure 9: MHPS local maxima depending on the frequency band of interest bandwidth. Top figure: frequency of the maximum. Bottom figure: probability of the maximum. HPS computed with 4 harmos and 2 sidebands (K=4, M=2) and focused around **BPFI**.

5. DISCLUSION

This study shows the adaptation of HPS and MHPS to IAS signal applied to rotating machine monitoring. These “new tools”, only adapted from very old processing techniques discovered in the 60’s in the domain of speech analysis to precisely track voice pitch, help IAS monitoring to step forward in the Condition-Monitoring-System hall of fame ! The precise detection of an early bearing fault is now proven to be possible far away from the encoder location. In this paper, signal information was indeed shown

able to step through the whole wind turbine shaft line. These tools present the ability to concatenate information from several elements of a set of harmonics, possibly modulated through a cyclic frequency, and therefore yields a more precise estimation of the characteristic frequency. This appears to be valuable in regards with two observations:

1. Vibration signals as well as IAS signals can contain a multitude of cyclic phenomena, especially since the whole shaft line can be observed from an encoder adroitly located. Once a bandwidth is determined by the expert as surrounding a characteristic frequency of interest, HPS or MHPS can respectively be used to clean this interval from either non harmonic content or non-modulated content.
2. Up to now, experts can hardly predict which harmonic number of a wide set makes the biggest contribution into the fault severity. Not only the diagnostic is simplified since the information is condensed in the characteristic frequency, but it is not needed anymore to follow simultaneously the various harmonics.

In the meantime, it is important to underline the drawbacks which were not overcome yet by the authors (damn them)... they are mainly linked to very strong hypothesis made at the beginning: the observed signal is expected to have one and only one set of harmonics.

1. If this is a real life signal, the chance is very few that only one set of harmonic set inhabits it. The expert must then be aware that the larger the frequency bandwidth, the smaller the harmonic set of interest, until it might not be prominent anymore. The proposal of the author to window the observation is suboptimal, since it increases the number of parameters to tune.
2. Going too far the other way, the risk that no set of harmonic lays within the frequency interval is also problematic. As was observed in this paper with healthy signal, it seems there is always a combination of frequency channel leading to something heavier than the average.

REFERENCES

- [1] L. Renaudin, F. Bonnardot, O. Musy, J.B. Doray, D. Rémond, Natural roller bearing fault detection by angular measurement of true instantaneous angular speed, *Mechanical Systems and Signal Processing*, Volume 24, Issue 7, October 2010, Pages 1998-2011, ISSN 0888-3270, <http://dx.doi.org/10.1016/j.ymssp.2010.05.005>.
- [2] H. André, F. Girardin, A. Bourdon, J. Antoni, D. Rémond, Precision of the IAS monitoring system based on the elapsed time method in the spectral domain, *Mechanical Systems and Signal Processing*, Volume 44, Issues 1-2, 20 February 2014, Pages 14-30, ISSN 0888-3270, <http://dx.doi.org/10.1016/j.ymssp.2013.06.020>.
- [3] M.R. Schroeder, period histogram and product spectrum: new methods for fundamental frequency measurement, *J. Acoust. Soc. Am.* 43 (1968) 829-834.
- [4] A.M. Noll, Pitch determination of human speech by the harmonic product spectrum, the harmonic sum spectrum, and a maximum likelihood estimate, In *Proceedings of the Symposium on Computer Processing Communications*, 1969 Pages. 779-797.
- [5] H. André, A. Bourdon, D. Rémond, On the use of the Instantaneous Angular Speed measurement in non-stationary mechanism monitoring. *Proceedings of the ASME 2011 International Design Engineering Technical Conferences & 23rd Biennial Conference on Mechanical Vibration and Noise, IDETC/CIE 2011*, Washington, DC, USA
- [6] P. D. McFadden, J. D. Smith, Model for the vibration produced by a single point defect in a rolling element bearing. *Journal of Sound Vibration*, vol. 96, 1984, p. 69-82.
- [7] J.L. Gomez, A. Bourdon, H. André, Didier Rémond, Modelling deep groove ball bearing localized defects inducing instantaneous angular speed variations, *Tribology International*, Volume 98, 2016, pp 270-281