



HAL
open science

Recycling of distillery effluents in alcoholic fermentation

Estelle Morin Couallier, Thierry Payot, André Pastore Bertin, Marie-Laure Lameloise

► **To cite this version:**

Estelle Morin Couallier, Thierry Payot, André Pastore Bertin, Marie-Laure Lameloise. Recycling of distillery effluents in alcoholic fermentation: Role in inhibition of 10 organic molecules. *Applied Biochemistry and Biotechnology*, 2006, 133, pp.217-237. 10.1385/ABAB:133:3:217 . hal-01593932

HAL Id: hal-01593932

<https://hal.science/hal-01593932>

Submitted on 26 Sep 2017

HAL is a multi-disciplinary open access archive for the deposit and dissemination of scientific research documents, whether they are published or not. The documents may come from teaching and research institutions in France or abroad, or from public or private research centers.

L'archive ouverte pluridisciplinaire **HAL**, est destinée au dépôt et à la diffusion de documents scientifiques de niveau recherche, publiés ou non, émanant des établissements d'enseignement et de recherche français ou étrangers, des laboratoires publics ou privés.

Recycling of Distillery Effluents in Alcoholic Fermentation

Role in Inhibition of 10 Organic Molecules

**E. MORIN COUALLIER,¹ T. PAYOT,² A. PASTORE BERTIN,¹
AND M. L. LAMELOISE*,¹**

¹ENSIA, UMR GENIAL, 1 Avenue des Olympiades,
91744 Massy Cedex, France, E-mail: mlam@ensia.fr;
and ²UNGDA, 174 Boulevard Camélinat, 92247 Malakoff Cedex, France

**Received June 20, 2005; Revised November 9, 2005;
Accepted November 29, 2005**

Abstract

In beet distilleries, condensates arising from stillage concentration could be recycled as dilution water for the fermentation step, thus preserving groundwater resources and ensuring a quality-controlled water supply. However, the recycling of condensates has been found to cause a significant reduction in fermentation activity. This study aimed to verify that condensates are toxic to alcoholic fermentation. Ten compounds found in condensates (formic, acetic, propionic, butyric, valeric, and hexanoic acids; 2,3-butanediol, furfuryl alcohol, furfural, and 2-phenyl-ethyl-alcohol) were tested. With the exception of 2,3-butanediol, they all proved to be inhibitors. At the same molar concentration, the longer the carbonaceous chain, the stronger the inhibition by fatty acids. An experimental design was used to study the inhibitory characteristics of the 10 compounds at the concentrations found in condensates. Synergistic effects were also confirmed. In real effluents, acetic acid was so highly concentrated that it became the strongest inhibitor. It is therefore necessary to eliminate it before recycling, as well as less concentrated compounds that may accumulate, as illustrated by the simulation.

Index Entries: Alcoholic fermentation; inhibition; condensates; effluent; recycling; fatty acids; 2,3-butanediol; furfuryl alcohol; furfural; 2-phenyl-ethyl-alcohol.

Introduction

Reducing water consumption and wastewater emissions is becoming a major challenge for agro-industry. The recycling or reuse of low-polluted

*Author to whom all correspondence and reprint requests should be addressed.

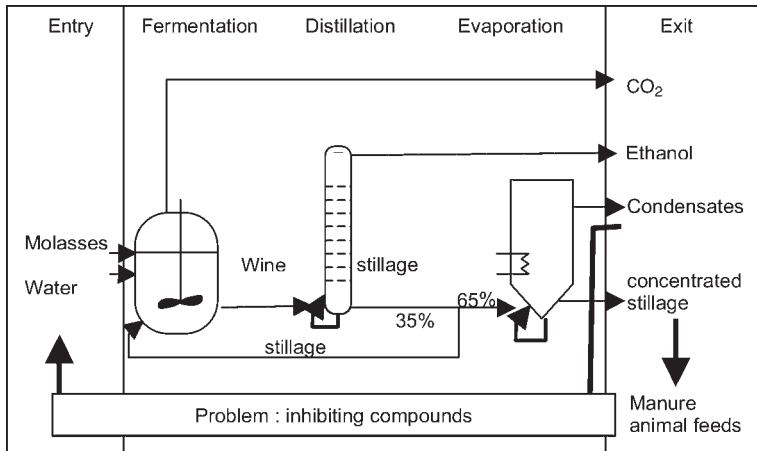

Fig. 1. Diagram of a beet distillery.

wastewater after adequate purification treatment may help to limit its environmental impact. Condensates constitute low-polluted water of considerable interest. In beet distilleries, for example, condensates arising from stillage concentration could be recycled as dilution water for the fermentation step, thus preserving groundwater resources and ensuring a quality-controlled water supply (Fig. 1) (1). However, distillers have found that the recycling of stillage condensates causes a significant reduction in fermentation activity. Effluents therefore need to be treated before reuse.

Several parameters can hinder fermentation (2): a very high sugar concentration in the initial wort, deficiencies in vitamins or nitrogen substrates, the presence of antiyeast factors in the must, anaerobic conditions, high temperatures, and wort degradation during fermentation. In this article, only the effects caused by the presence of inhibiting compounds are considered.

Different molecules are listed in the literature as inhibitors of alcoholic fermentation. The inhibition of *Saccharomyces cerevisiae* on different substrates (grape must, beet molasses, and cellulose hydrolysates) has been studied (2–8). The inhibition of other microorganisms (*Escherichia coli*, *Bacillus thermophilus*) that are used to produce alcohol has also been studied (9–13). The inhibiting compounds are benzenic, furanic, and aliphatic acids, aldehydes, and alcohols (Tables 1–3).

Several mechanisms have been proposed to explain inhibition: some organic acids in molecular form act as proton carriers through the cell membrane and weaken the flux of nutrients (14), caprylic and capric acids solubilize in the membrane and lead to a loss of membrane integrity and yeast death (15), and furfural may block glycolysis and fermentation enzymes (16). According to Maiorella et al. (17), small linear alcohols (e.g., propanol) cause a reduction in membrane integrity and cell deforma-

Table 1
Aliphatic Inhibiting Compounds

	Name	Formula	MW (g/mol)	Bp (°C)	pKa
Aliphatic acids	Formic acid		46,03	100,8	3,8
	Acetic acid		60,05	118,1	4,8
	Caproic acid		116,16	207,7	4,9
	Caprylic acid		144,22	237,5	4,9
	Pelargonic acid		158,23	253	4,96
	Capric acid		172,27	268	4,9
	Lauric acid		200,33	225 (105 mmHg)	
Other acids	Lactic acid		90,08	122 (14 mmHg)	3,8
	Levulinic acid		116,11	(d. 245°C)	4,6
	Sorbic acid		112,12	(d. 228°C)	4,76
Aldehyde	Acetaldehyde		44,05	20,8	
Alcohols	Propanol		60,1	97,4	
	Glycerol		92,09	(d. 290°C)	
			88,15	127	

MW, molecular weight; Bp, boiling point; d, decomposition; f, fusion.

tion. Some small compounds cause osmotic pressure to increase and to slow down the excretion of ethanol, which becomes toxic to the cell (18). Several investigators have suggested synergetic effects between different compounds (8–10). All the mechanisms described disrupt yeast adaptation to the wort, slow yeast growth, and cause a reduction in alcohol production.

Table 2
Furanic Inhibiting Compounds

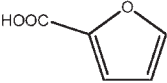
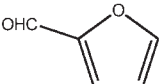
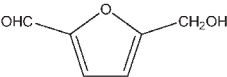
	Name	Formula	MW (g/mol)	Bp (°C)	pKa
Furanes	Furoic acide		112,09	230	3,17
	Furfural		96,09	161,5	/
	5-hydroxy-methyl-furfural		126,11	114	/

MW, molecular weight; Bp, boiling point; d, decomposition; f, fusion.

A previous qualitative analysis (19) showed that condensates from distilleries contain many potentially inhibiting compounds. Ten target molecules have been selected to model these solutions: formic, acetic, propionic, butyric, valeric, and hexanoic acids; 2,3-butanediol; furfuryl alcohol; furfural; and 2-phenyl-ethyl-alcohol. They were chosen either because they are the most concentrated, because they are well-known inhibitors, or because they are chemically similar to toxic molecules (propionic, butyric, and valeric acids; 2,3-butanediol; furfuryl alcohol). They have all been quantified in real products (1). Table 4 summarizes their concentrations in effluents.

The concentrations that lead to the inhibition of alcoholic fermentation with some of these compounds (inhibition of the growth of microorganisms related to the concentration of cells) have been recorded in the literature for *S. cerevisiae* and other microorganisms (*B. thermophilus* and *E. coli*) (Table 5). Their concentrations in the effluents studied are much lower and the condensates should therefore not be so toxic.

The aim of the present study was to measure the inhibition of alcoholic fermentation by condensates in order to confirm the choice of the 10 target molecules as inhibitors, to classify them as a function of their inhibitory potential, and to confirm the hypothesis of synergistic effects between some of them. This work has made it possible to define those toxic molecules that need to be removed before condensates can be recycled in alcoholic fermentation.

Materials and Methods

The fermentation test used had previously been developed by the Union Nationale des Groupements des Distillateurs d'Alcool (UNGDA) to evaluate the fermentability of industrial molasses (21). This test consists of

Table 3
Benzenic Inhibiting Compounds

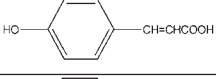
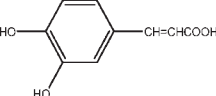
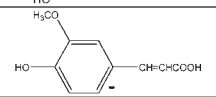
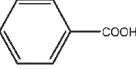
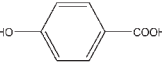
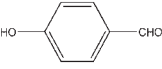
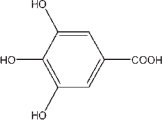
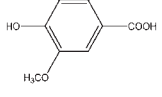
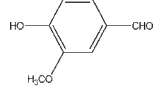
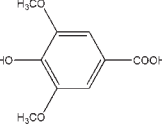
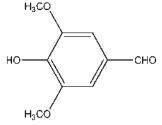
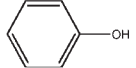
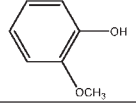
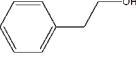
	Name	Formula	MW (g/mol)	Bp (°C)	pKa
Cinnamic acid derivatives	p-coumaric acid		164,16	(f. 210°C)	
	Cafeic acid		180,16	(d. 225°C)	
	Ferulic acid		194,18	(f. 169°C)	
Hydroxy-benzoic acid derivatives	Benzoic acid		122,12	249°C	4,19
	Hydroxy-4 benzoic acid		138,12	(f. 214°C)	4,6
	Hydroxy-4 benzaldehyde		122,12	(f. 114°C)	/
	Galic acid		170,12	(lose H ₂ O 100°C)	4,4
Methoxy-benzoic acid derivatives	Vanillic acid		168,14	(f. 210°C)	4,5
	Vanillin		152,5	(f. 81°C)	/
	Syringic acid		198,17	(f. 204°C)	
	Syringaldehyde		182,17	(f. 110°C)	/
Alcohols	Phenol		94,11	181,7	/
	Guaiacol		124,14	205	/
	Phenyl-ethyl-alcohol		122,17	203,4	/

MW, molecular weight; Bp, boiling point; d, decomposition; f, fusion.

Table 4
Ten Target Molecules Studied, Their Properties,
and Their Concentrations in Real Condensates

Compound	Mol wt (g/mol)	Eb (°C)	p <i>K_a</i>	Concentration (mmol/L) in real condensates
Formic acid	46.03	100.7	3.75	0.4–2.6
Acetic acid	60.05	118.6	4.75	15–50
Propionic acid	74.08	141	4.87	0.9–3
Butyric acid	88.11	165.6	4.81	0.6–2.3
Valeric acid	102.13	186	4.82	0–1
Hexanoic acid	116.16	205	4.88	0–0.1
2,3-Butanediol	90.12	182.5		5.6–8.9
Furfuryl alcohol	98.10	171		0–0.05
Furfural	96.09	161.7		0–0.3
Phenyl-2-ethyl-alcohol	122.17	218.2		0–0.08

Table 5
Concentrations of Toxic Molecules Leading to Inhibition
of Alcoholic Fermentation^a

Compound	Data in literature		
	Concentration (mmol/L)	Inhibition (%)	References
Formic acid	60	80	17
Acetic acid	90–170	80–100	6,17,20
Hexanoic acid	86 (<i>E. coli</i>)	100	9
Furfural	8.3 (<i>B. thermophilus</i>)	96	13
Furfural	36.4 (<i>E. coli</i>)	100	10
Phenyl-2-ethyl-alcohol	8.1	Inhibitory	5
Phenyl-2-ethyl-alcohol	33	Toxic	5

^aInhibition of the growth of microorganisms related to the concentration of cells. *S. cerevisiae* when not specified.

measuring the mass loss owing to carbon dioxide degassing during ethanol production in a batch fermentation:

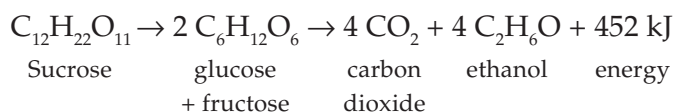

Products and Chemicals

The molasses used to prepare the media was purchased from a distillery named A, and had the following characteristics: 50 g of sucrose/100 g of molasses, dry matter of 78% (w/w), and purity of 67.

Malt Wickerham medium, used to make yeast develop prior to inoculation, was prepared from 3 g of malt extract, 5 g of peptone (from animal proteins), 3 g of yeast extract, and 10 g of glucose diluted in 1 L. The pH was adjusted to 5.0 with sulfuric acid (120 mg/L). The solution was then distributed into 9-mL tubes and sterilized at 120°C.

All compounds were of analytical grade (purity > 99%). Butyric, valeric, and hexanoic acids; 2,3-butanediol; furfuryl-alcohol; furfural; and 2-phenyl-ethyl-alcohol were purchased from Aldrich. Formic and sulfuric acids and diammonium phosphate were from Prolabo and acetic acid was from Labosi. Tap water was used to prepare the solutions and contained the necessary minerals (e.g., calcium). Condensate samples were obtained from three distilleries named A, B, and C.

Microorganism

S. cerevisiae D10 yeast was obtained from the UNGDA yeast culture collection, Malakoff, France. Preliminary cultures were performed for 24 h in liquid malt Wickerham medium.

Fermentation Test

One hundred milliliters of wort was prepared using 26.5 g of molasses, 1 drop of antifoamer, 1 mL of diammonium phosphate (5% [w/w]), and 120 g/L of sulfuric acid to reach pH 4.5. Dilutions were performed using tap water or the study solution. One milliliter of yeast preculture was added to 30 mL of wort and placed in a 50-mL Erlenmeyer flask, which was then closed with aluminum foil to restrict evaporation and allow the release of CO₂. Samples were incubated at 33°C in a rotary shaker at 200 rpm for 24 h. The course of fermentation was followed by weighing the flasks at 0, 16, 18, 20, 22, and 24 h and measuring mass loss. One reference experiment was realized per preculture by fermenting a wort prepared with tap water. Mass loss was owing to the release of carbon dioxide, formed at the same time as ethanol and at the same molar proportions. The lower the mass loss, the stronger the inhibition. Inhibition criteria were defined as in Eq. 1:

$$inhib(t) = 1 - \frac{\Delta P_i(t)}{\Delta P_{reference}(t)} = \frac{\Delta P_{reference}(t) - \Delta P_i(t)}{\Delta P_{reference}(t)} \quad (1)$$

in which $\Delta P_i(t)$ is the mass loss with tested solution at t instant (g), and $\Delta P_{reference}(t)$ is the mass loss with reference solution (water) at t instant (g).

Molasses were used as the raw material. This product had been demonstrated to contain the same toxic molecules (19). Concentrations in the wort were therefore underestimated. However, we chose to work with the same raw material, in order to mimic the conditions prevailing in an industrial setting.

The mass losses found during reference experiments were 1.03 ± 0.07 and 2.15 ± 0.03 g at 16 and 24 h, respectively. These losses were between 0 (total inhibition) and 2.15 g (no inhibition) in the presence of inhibiting

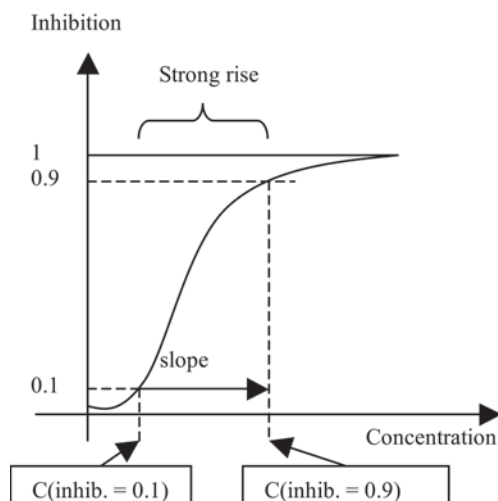

Fig. 2. Increase in inhibition vs concentration.

compounds. Evaporation took part in the mass loss for a maximum of 0.01 g. The accuracy of the inhibition criteria was ± 0.05 .

Inhibition is often more marked after 16 h of fermentation than after 24 h. This observation can be explained by the inhibition mechanism. Ethanol and CO_2 production may be slower before 16 h and then accelerate during the next 8 h.

The inhibition of fermentation was studied using three different types of wort: wort prepared with real condensates to dilute the molasses, wort prepared with model condensates containing only one inhibiting molecule in solution at different concentrations, and wort prepared with a mixture of the 10 target compounds according to an experimental design.

Conditions

Single Compounds

The concentrations of the toxic molecules added separately to the must in order to study inhibition were as follows: 0–109 mmol/L of formic acid, 0–333 mmol/L of acetic acid, 0–68 mmol/L of propionic acid, 0–57 mmol/L of butyric acid, 0–20 mmol/L of valeric acid, 0–8.6 mmol/L of hexanoic acid, 0–222 mmol/L of 2,3-butanediol, 0–51 mmol/L of furfuryl alcohol, 0–10.4 mmol/L of furfural, 0–8.2 mmol/L of 2-phenyl-ethyl-alcohol. They were chosen as a function of the inhibition produced. The aim was to describe the inhibition profile between 0 and 100% vs the concentration (Fig. 2).

Real and Model Condensates

Table 6 provides the concentrations of target molecules in real condensates from distilleries A, B, and C and those in the model condensate.

Table 6
Concentrations of Target Molecules in Real and Model Condensates^a

Concentration (mmol/L)	Real condensates A	Real condensates B	Real condensates C	Model condensates
Formic acid	1.1	2.6	0.6	3.3
Acetic acid	15.3	38.5	24	33
Propionic acid	1.1	2.8	2.6	1.6
Butyric acid	0.7	1.5	2.2	2
Valeric acid	Around 0.1	0.7	0.24	0.51
Hexanoic acid	ε	Around 0.05	Around 0.04	0.04
2,3-Butanediol	8.3	6.4	8.4	11.1
Furfuryl alcohol	ND	ND	ND	0.6
Furfural	Around 0.02	0.29	Around 0.02	0.08
Phenyl-2-ethyl-alcohol	Around 0.04	Around 0.06	0.07	0.15

^aAround, the concentration was near the quantification limit; ε, present but not quantifiable; ND, not determined.

Experimental Design

The effects of the 10 target compounds on inhibiting alcoholic fermentation in a complex medium were determined using the two-level fractional factorial design 2¹⁰⁻³. The lower concentration (level -1) was 0 mmol/L, and the higher concentration (level +1) was determined according to the results of experiments with single compounds. The effects of the compounds on mass loss (CO₂ production) were measured and related to the "inhibition" response. A resolution (V) was chosen so that no main effect or two-factor interaction was aliased with any other main factor or two-factor interaction. However, two-factor interactions were aliased with three-factor interactions. This design corresponded to a total of 128 experiments.

Results and Discussion

Inhibition by Real Condensates From the Three Distilleries A, B, and C

Inhibition by real condensates was measured using the fermentation test described in the Fermentation Test section (Fig. 3). Effluents B and C totally inhibited fermentation; no mass loss was observed. Effluent A was less inhibitory. This could be explained by the lower concentrations measured (Table 6); the condensate was cleaner because it was a mixture of vapors arising from stillage evaporation and the water boiler. Condensates C were diluted with tap water to verify whether recycling was possible. Condensates diluted twice still inhibited 60% of fermentation, and 5% when diluted 12 times. Thus, recycling would not be possible with slightly diluted effluents, and they would need to be treated. To highlight the most toxic compounds and measure their effects, the inhibition of alcoholic fermentation was therefore studied using single target compounds.

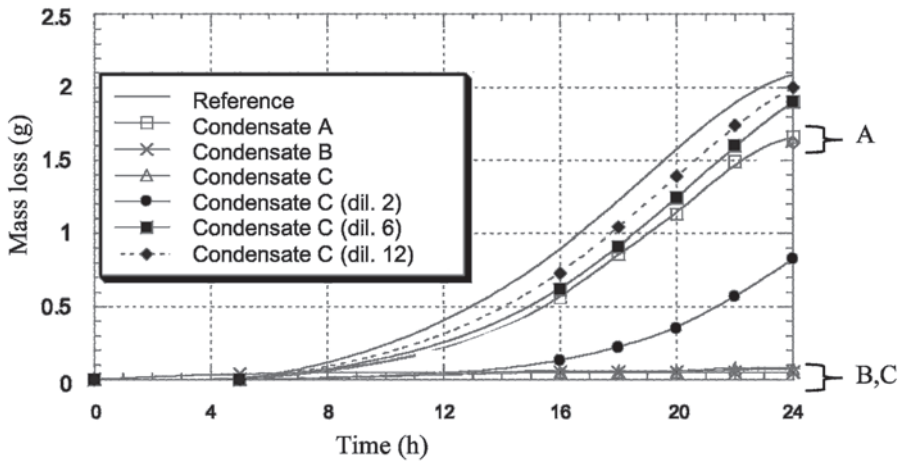

Fig. 3. Inhibition by real condensates from three distilleries: A, B, and C. Mass loss vs fermentation time is shown.

Inhibition by Single Compounds

The inhibition of fermentation was studied using wort prepared with solutions containing one target compound and tap water. Inhibition after 16 and 24 h vs the initial concentration was calculated, and the details are shown in Figs. 4 and 5. With all compounds, there was a nonlinear relationship between the inhibition of alcohol production and the concentration of toxic molecules. An increase in inhibition was observed, with slopes from start concentrations (corresponding to 10% of inhibition) and end concentrations (corresponding to 90% of inhibition) that depended on the compound. The concentrations studied did not allow observation of an increase with 2,3-butanediol. Table 7 summarizes the start and end concentrations. Hexanoic acid became toxic (0.5 mmol/L) much earlier than acetic acid (10 mmol/L), and its maximum of inhibition was attained rapidly (1.5 mmol/L) compared with that of acetic acid (100 mmol/L). Figure 6 presents the inhibition curves vs inhibitor concentrations corresponding to acids (Fig. 6A) and all the compounds (Fig. 6B). The longer the carbon chains of the acids, the stronger the inhibition, and the earlier the increase started, the shorter the slope. Furfural appeared to display the same inhibition as valeric acid, 2-phenyl-ethyl-alcohol as propionic and butyric acids, and furfuryl-alcohol as formic and acetic acids. 2,3-Butanediol was not inhibitory. Some compounds at low concentrations were as inhibitory as others at higher concentrations. The inhibiting concentrations measured for formic and acetic acids and 2-phenyl-ethyl-alcohol were comparable with those described in the literature for *S. cerevisiae* (Table 7), and the value for furfural was comparable with that seen for *B. thermophilus*. However, the concentrations for furfural and hexanoic acid were weaker than those seen with *E. coli*, which was more resistant.

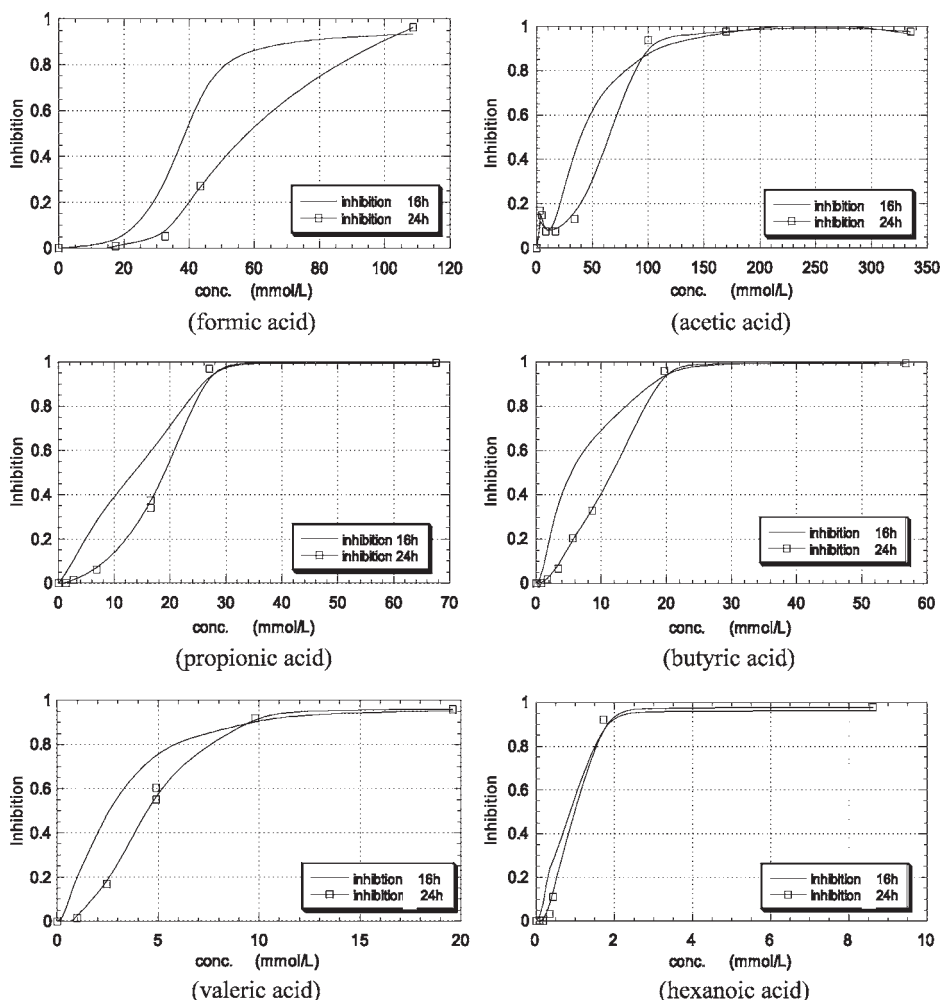

Fig. 4. Inhibition of fermentation vs concentration of inhibitory substances (acid compounds).

Prediction of Inhibition by Real Condensates

Table 8 presents the inhibition of CO₂ production caused by single target compounds as a function of their concentration in condensates. The maximum sum of all values was equal to 38%, whereas condensates B and C inhibited 100% of alcoholic production. This discrepancy could be explained by the influence of other compounds or by synergistic effects. To eliminate the effect of any other compound and thus to assess the existence of synergistic effects, inhibition by a model solution containing only the 10 target compounds (*see* Materials and Methods) was measured. Total inhibition without synergistic effects should have been maximum equal to 21%, but measurement gave in fact 55%. The presence of a synergistic effect was thus proved. These results show that there is no additive relationship between the inhibitions of different molecules.

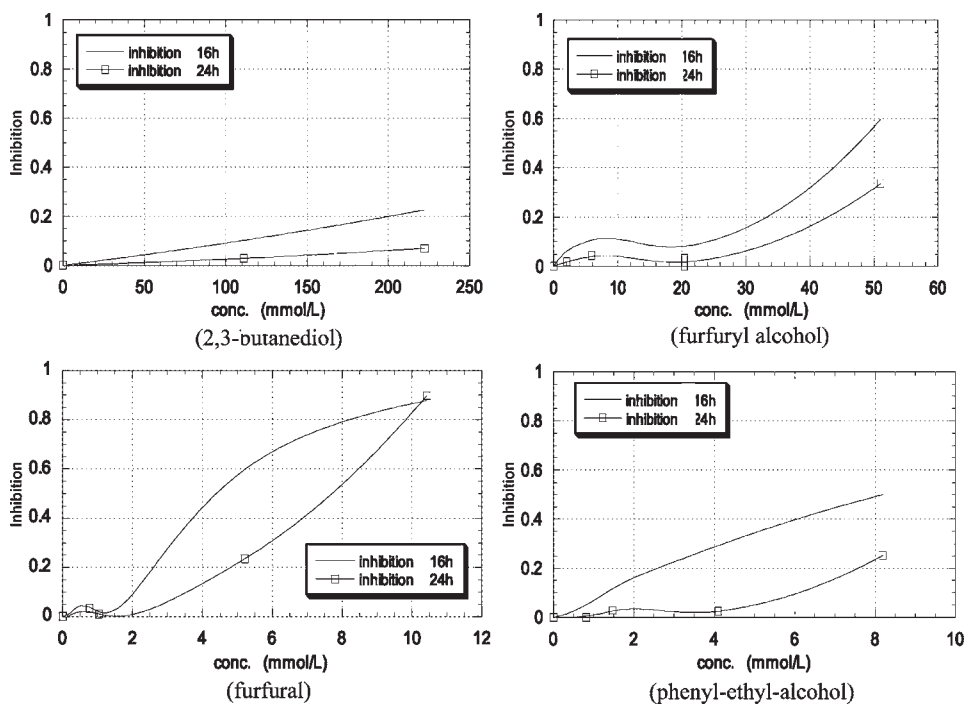

Fig. 5. Inhibition of fermentation vs concentration of inhibitory substances (neutral compounds).

Table 7
Characteristics of Increase in Inhibition vs Concentration
(Start Concentration, End Concentration)

Compound	Experimental values	
	Concentration (mmol/L) to reach 10% of inhibition (24 h)	Concentration (mmol/L) to reach 90% of inhibition (24 h)
Formic acid	35	100
Acetic acid	10	100
Propionic acid	8	26
Butyric acid	4	18
Valeric acid	2	9
Hexanoic acid	0.5	1.5
2,3-Butanediol	110	>>220
Furfuryl alcohol	35	>50
Furfural	3.5	11
Phenyl-2-ethyl-alcohol	6.2	>8

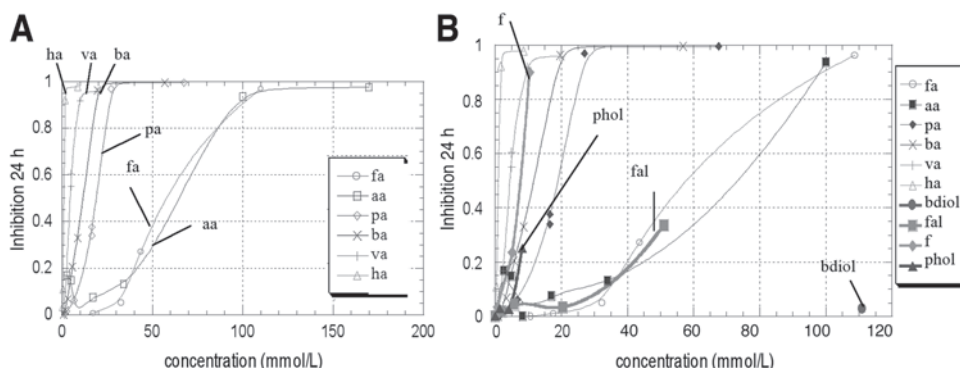

Fig. 6. Inhibition (24 h) vs concentrations of compounds: **(A)** acid compounds; **(B)** neutral and acid compounds. fa, formic acid; aa, acetic acid; pa, propionic acid; ba, butyric acid; va, valeric acid; ha, hexanoic acid; bdiol, 2,3-butanediol; fal, furfuryl alcohol; f, furfural; phol, 2-phenyl-ethyl-alcohol.

Effect of Each Compound in a Mixture and Interactions

The experimental design aimed to evaluate the effect of each inhibiting compound and synergistic effects between two of them. Interactions between three or more compounds were considered negligible. The test consisted of measuring the inhibition provoked by 128 mixtures containing 10 or fewer target compounds, the composition of each mixture being determined by the experimental design described in Materials and Methods. To ensure that the results would be interpretable, the inhibition provoked by the mixture of all compounds needed to be <100%.

Choice of Concentrations Corresponding to Level +1

The concentrations chosen for the initial mixture corresponded to 5–10% of inhibition after 24 h of fermentation, so that their inhibitory activity could be measured, although the values differed slightly from those found in condensates. For this reason, furfural and 2-phenyl-ethyl-alcohol were more concentrated and acetic acid less concentrated than in condensates. The inhibition obtained with these concentrations was too high (100%), and the mixture had to be diluted 2.5 times to produce inhibition of only 80%, or the results would not have been interpretable. Table 9 summarizes the concentrations finally used under the experimental design corresponding to level +1.

Results of Experimental Design

Calculation of the standard deviation (SD) for the experimental design was based on eight reference tests performed using eight different yeast precultures. This SD was equal to 7.4% at 16 h and 1.4% at 24 h. An effect needed to be stronger than the SD to be significant. The results measured at 24 h are discussed next.

Table 8
Comparison of Measured and Predicted Inhibition of Real and Model Condensates

Compound	Real condensates		Model condensates	
	C (mmol/L)	Inhibition by single compound (24 h) (%)	C (mmol/L)	Inhibition by single compound (24 h) (%)
Formic acid	0.4-2.6	0	3.3	0
Acetic acid	15-40	10-20	33	13
Propionic acid	1-3	0-1	1.6	0
Butyric acid	0.7-2.5	0-10	2	2
Valeric acid	0-0.7	0-5	0.5	0
Hexanoic acid	0-0.05	0-1	0.043	0
2,3-Butanediol	6-8.5	0	11.1	0
Furfuryl alcohol	ND	ND	0.61	0-5
Furfural	0-0.3	0-1	0.08	0-1
Phenyl-2-ethyl-alcohol	0.007	0	0.15	0
Range of sum of inhibitions by single compounds (prediction)		10-38		15-21
Inhibition by mixture (experimental values)		A: 25 B-C: 100		55

ND, not determined.

Table 9
Concentration of Target Compounds
Used in Experimental Design Level +1

Compound	Concentration (mmol/L)
Formic acid	8.7
Acetic acid	6.7
Propionic acid	2.7
Butyric acid	1.3
Valeric acid	0.8
Hexanoic acid	0.18
2,3-Butanediol	44
Furfuryl alcohol	0.4
Furfural	2.3
Phenyl-2-ethyl-alcohol	1.7

Effects and interactions were all lower than 10%. This could be explained by the low concentrations used. Four groups of toxic molecules were compiled with respect to their effects on alcoholic fermentation. They are described vs the SD in Fig. 7 and Table 10:

1. Highly toxic compounds (effect between 5 and 7 SD) (+++): butyric and valeric acids.
2. Moderately inhibiting compounds (effect between 3 and 5 SD) (++): propionic and hexanoic acids and phenyl-2-ethyl-alcohol.
3. Slightly inhibiting compounds (effect between 1 and 3 SD) (+): formic and acetic acids and furfuryl-alcohol.
4. Noninhibiting compounds (<1 SD) (ns): 2,3-butanediol and furfural at the concentrations studied.

No interactions were significant. This may have been owing to the weak concentrations used, so that any interactions would have been too slight to be measured.

Table 11 compares the results of the studies on single compounds at the same molar concentration, single compounds at condensate concentrations, and the results produced by the experimental design. It confirms that some molecules at low concentrations were more inhibiting than others present in higher proportions. The correlation between carbon chain length and inhibition highlighted for single compounds at the same concentration did not appear in the other studies. This could be explained by the concentrations employed in the experimental design. Valeric acid was four times more concentrated than hexanoic acid and caused more marked inhibition. Furfural was less concentrated than most of the molecules and was considered to be nontoxic, despite its high inhibition potential. Acetic acid was so highly concentrated in condensates that it was the most inhibiting compound.

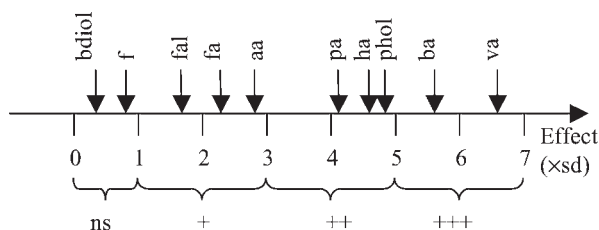

Fig. 7. Classification of inhibitors of alcoholic fermentation based on experimental design. fa, formic acid; aa, acetic acid; pa, propionic acid; ba, butyric acid; va, valeric acid; ha, hexanoic acid; bdiol, 2,3-butanediol; fal, furfuryl alcohol; f, furfural; phol, phenyl-2-ethyl-alcohol.

Table 10
Inhibition Levels of Target Compounds
Determined From Experimental Design^a

Compound	Inhibition
Formic acid	+
Acetic acid	+
Propionic acid	++
Butyric acid	+++
Valeric acid	+++
Hexanoic acid	++
2,3-Butanediol	ns
Furfuryl alcohol	+
Furfural	ns
Phenyl-2-ethyl-alcohol	++
Interactions	ns

^a(ns), non-inhibitory; (+) slightly inhibitory; (++) moderately inhibitory; (+++) toxic compound.

Three groups were then made up to cover all the results obtained:

1. Strongest inhibiting compounds (+++ and ++).
2. Slightly inhibiting compounds (+).
3. Noninhibiting compounds (ns).

This classification corresponded to the values found in the case of real condensates, with the exception of acetic acid. It highlights the molecules at low concentrations that could become dangerous.

In light of these results, it will therefore be important to eliminate acetic acid, which is the most concentrated compound, before recycling condensates in alcoholic fermentation. However, the other molecules should not be neglected because their accumulation in the distillery could lead to a halt of fermentation.

Table 11
 Classification of Target Compounds vs Their Inhibitory Potential Measured on Separate Molecules and Mixtures

Single compounds (same molar concentration)	C (mmol/L)	Single compounds (concentration in real condensates)	C _{max} (mmol/L) (see Table 6)	Results of experimental design	C (mmol/L)
Most inhibitory					
Hexanoic acid	10	Acetic acid	38.5	Valeric acid	0.8
Valeric acid	10	Butyric acid	2.2	Butyric acid	1.3
Furfural	10	Valeric acid	0.7	Phenyl-2-ethyl alcohol	1.7
Butyric acid	10	Propionic acid	2.8	Hexanoic acid	0.18
Phenyl-2-ethyl-alcohol	10	Hexanoic acid	0.05	Propionic acid	2.7
Propionic acid	10	Furfural	0.3	Acetic acid	6.7
Acetic acid	10	Phenyl-2-ethyl alcohol	0.07	Formic acid	8.7
Furfuryl alcohol	10	Formic acid	2.6	Furfuryl alcohol	2.3
Formic acid	10	2,3-Butanediol	8.4	Furfural	0.4
2,3-Butanediol	10	Furfuryl alcohol	ND	2,3-Butanediol	44

ND, not determined.

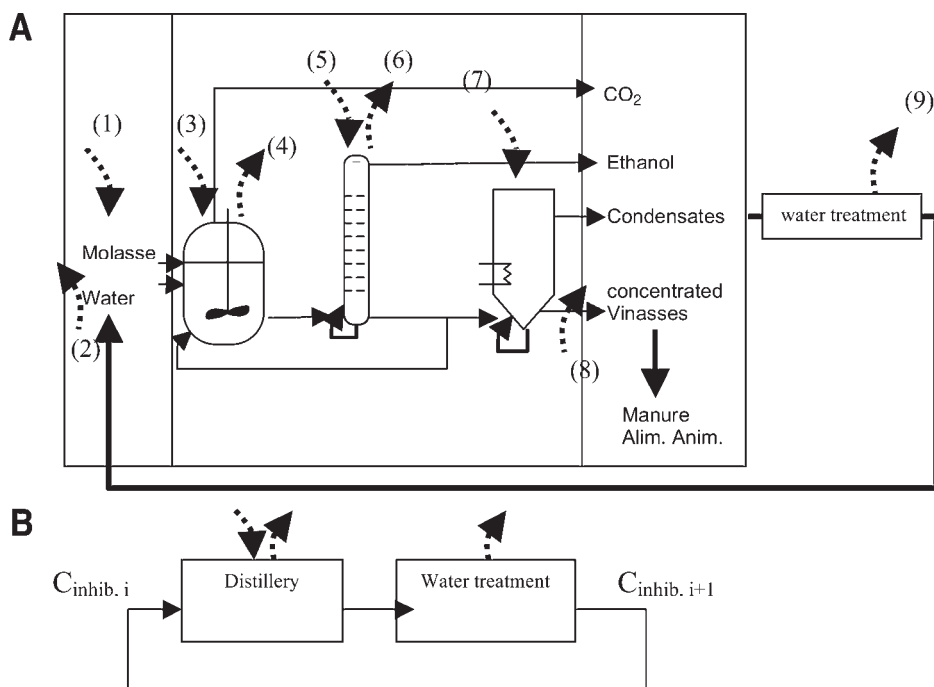

Fig. 8. Introduction, creation, and elimination of inhibitory compounds in a distillery. (1) Introduction/(3),(5),(7) creation/(2) dilution/(4),(6),(8),(9) elimination.

Simulation

In a previous study (19), it was shown that inhibitory compounds are either introduced via the raw material or created in the distillery during the process. Most of the acids were present in molasses but were insufficiently concentrated to halt fermentation. Their dilution with fresh water thus diminished their concentration. Other molecules (acetic acid, 2,3-butanediol, phenyl-2-ethyl-alcohol, furfural) were produced during fermentation, distillation, or evaporation. Some compounds may also be degraded or accumulate in concentrated stillage and not undergo evaporation. The introduction of a water treatment step after evaporation would enable a reduction in the quantity of inhibitors contained in condensates before reuse. Figure 8A illustrates these phenomena.

The accumulation of an inhibitory substance introduced into alcoholic fermentation during the total recycling of condensates was simulated through the use of Eq. 2 and according to Fig. 8B:

$$C_{inhib, i+1} = C_{inhib, i} + C_{creat.} - K_{elim.} \times (C_{inhib, i} + C_{creat.}) \quad (2)$$

in which i is the number of cycles; $C_{inhib, i}$ (mmol/L) is the concentration of the molecule under consideration, introduced in the water used to dilute the molasses; $C_{inhib, i+1}$ (mmol/L) is the concentration of the considered molecule in condensates; $C_{creat.}$ (mmol/L) is the increase in the concentration of

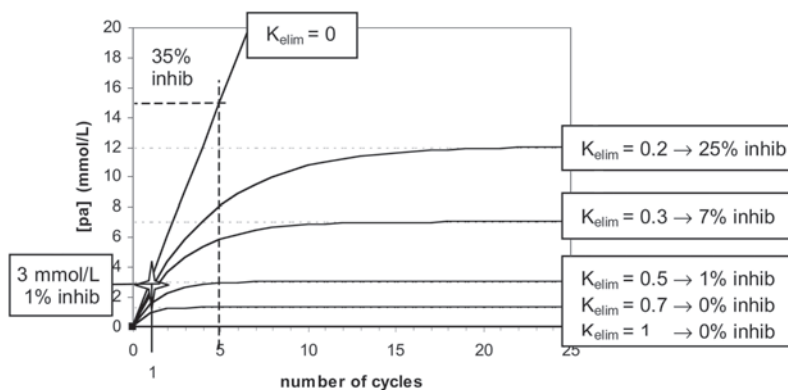

Fig. 9. Simulation of propionic acid (pa) accumulation during recycling of condensates in alcoholic fermentation (inhib: inhibition).

the considered molecule through its introduction via molasses or its creation in the distillery; and K_{elim} (-) is the proportion of molecule eliminated by a water treatment step.

After a large number of recycling processes, inhibitory concentrations attained a limit that could be defined from C_{creat} and K_{elim} (Eq. 3):

$$C_{limit} = C_{creat} / K_{elim} - C_{creat} \tag{3}$$

Figure 9 presents an example of the accumulation of propionic acid in distilleries. The first cycle corresponded to the fermentation of a wort prepared using fresh water. After the first cycle without elimination, the propionic acid concentration measured in condensates (1) was 3 mmol/L, a concentration that would cause 1% inhibition using the fermentation test described in the Fermentation Test section. If the inhibitor were not eliminated before recycling ($K_{elim} = 0$), the concentration after five cycles would be 15 mmol/L, generating 35% inhibition. If a water treatment step were introduced before recycling, the propionic acid concentration would reach a limit dependent upon the quality of the elimination process. If 20% of the acid were removed from the condensates before recycling, its concentration would reach 12 mmol/L and cause 25% inhibition. If 50% of the acid was eliminated, the limit concentration would be 3 mmol/L and cause only 1% inhibition.

It was thus demonstrated that a compound that is not concentrated enough in the actual studied condensates to inhibit the fermentation could become dangerous after several recycling cycles. It is necessary to make sure that the low concentrated molecules are eliminated before recycling the condensates in alcoholic fermentation. A wastewater treatment leading to the elimination of the several inhibitory compounds simultaneously would be interesting. Reverse osmosis and/or adsorption ion exchange are interesting solutions to be evaluated.

Conclusion

This study made it possible to verify that untreated condensates are toxic to fermentation. When tested separately, it was shown that all the chosen target compounds were inhibitory with the exception of 2,3-butanediol. When acids were considered at the same concentration (e.g., 1.7 mmol/L), the longer the carbonaceous chain, the more inhibitory was the compound. That is why hexanoic acid could be as inhibitory as more highly concentrated compounds. At the same molar concentration, furfural was as toxic as valeric acid, 2-phenyl-ethyl-alcohol as toxic as propionic and butyric acids, and furfuryl alcohol as toxic as formic and acetic acids.

By applying an experimental design, it was possible to demonstrate that the most toxic molecules were propionic, butyric, valeric, and hexanoic acids; and phenyl-2-ethyl-alcohol. These were followed by formic and acetic acids and furfuryl alcohol. Furfural at the concentration found in the condensate, and 2,3-butanediol, were not toxic to the yeast. Synergistic effects were confirmed but not quantified.

In real effluents, acetic acid is so highly concentrated that it becomes the most inhibitory compound. It will therefore be important to eliminate this compound, as well as less strongly concentrated substances that might accumulate during recycling, as illustrated by the simulation.

Acknowledgment

We wish to thank E. Piffeteau for her significant help during the experiments.

References

1. Morin Couallier, E. (2004), PhD thesis, Ecole Nationale Supérieure des Industries Agricoles et Alimentaires, Massy, France.
2. Lafon-Lafourcade, S., Geneix, C., and Ribéreau-Gayon, P. (1984), *Appl. Environ. Microbiol.* **47**, 1246–1249.
3. Ravaglia, S. and Delfini, C. (1994), *Wein-Wissenschaft* **49**, 40–45.
4. Viegas, C. A. and Sa-Correia, I. (1995), *Enzyme Microb. Technol.* **17**, 826–831.
5. Stark, D., Münch, T., Sonnleitner, B., Marison, I. W., and von Stockar, U. (1998), in *2nd European Symposium on Biochemical Engineering Science, Porto*.
6. Edwards, C. G., Reynolds, A. D., Rodriguez, A. V., Semon, M. J., and Mills, J. M. (1999), *Am. J. Oenol. Viticul.* **50**, 204–210.
7. Luo, C. D., Brink, D. L., and Blanch, H. W. (2002), *Biomass Bioenergy* **22**, 125–138.
8. Martin, C., Galbe, M., Nilvebrant, N. O., and Jönsson, L. J. (2002), *Appl. Biochem. Biotechnol.* **98–100**, 699–716.
9. Zaldivar, J. and Ingram, L. O. (1999), *Biotechnol. Bioeng.* **66**, 203–210.
10. Zaldivar, J., Martinez, A., and Ingram, L. O. (1999), *Biotechnol. Bioeng.* **65**, 24–33.
11. Gutierrez, T., Buszko, M. L., Ingram, L. O., and Preston, J. F. (2002), *Appl. Biochem. Biotechnol.* **98–100**, 327–340.
12. Sene, L., Converti, A., Zilli, M., Felipe, M. G. A., and Silva, S. S. (2001), *Appl. Microbiol. Biotechnol.* **57**, 738–743.
13. Thomasser, C., Danner, H., Neureiter, M., Saidi, B., and Braun, R. (2002), *Appl. Biochem. Biotechnol.* **98–100**, 765–773.

14. Stevens, S. and Servaas Hofmeyr, J.-H. (1993), *Appl. Microbiol. Biotechnol.* **38**, 656–663.
15. Stratford, M. and Anslow, P. A. (1996), *FEMS Microbiol. Lett.* **142**, 53–58.
16. Larue, F., Lafon-Lafourcade, S., and Ribéreau-Gayon, P. (1984), *Biotechnol. Lett.* **6**, 687–692.
17. Maiorella, B., Blanch, H. W., and Wilke, C. R. (1983), *Biotechnol. Bioeng.* **XXV**, 103–121.
18. Bouix, M. and Leveau, J. Y. (1993) in *Microbiologie industrielle, les micro-organismes d'intérêt industriel*, Leveau, J. Y. and Bouix, M., eds., Te. et Doc. Lavoisier, Paris, pp. 2–100.
19. Morin, E., Bleton, J., Lameloise, M. L., Tchaplal, A., and Decloux, M. (2003), *Industries Alimentaires Agricoles* **7–8**, 15–21.
20. Thomas, K. C., Hynes, S. H., and Ingledew, W. M. (2002), *Appl. Environ. Microbiol.* **68**, 1616–1623.
21. De Miniac, M. (1984), *Industries Alimentaires Agricoles* **101**, 123–135.
22. Weast, R. C. (1985), in *Handbook of Data on Organic Compounds*, Weast, R. C. and Astle, M. J., eds., CRC Press, Boca Raton, FL.