



HAL
open science

Serotonin 2B receptors in mesoaccumbens dopamine pathway regulate cocaine responses

Stephane Doly, Emily Quentin, Raphaël Eddine, Stefania Tolu, Sebastian P Fernandez, Jesus Bertran-Gonzalez, Emmanuel Valjent, Arnauld Belmer, Xavier Viñals, Jacques Callebert, et al.

► To cite this version:

Stephane Doly, Emily Quentin, Raphaël Eddine, Stefania Tolu, Sebastian P Fernandez, et al.. Serotonin 2B receptors in mesoaccumbens dopamine pathway regulate cocaine responses. *Journal of Neuroscience*, 2017, 37 (43), pp.10372-10388. 10.1523/JNEUROSCI.1354-17.2017 . hal-01593826

HAL Id: hal-01593826

<https://hal.science/hal-01593826v1>

Submitted on 26 Sep 2017

HAL is a multi-disciplinary open access archive for the deposit and dissemination of scientific research documents, whether they are published or not. The documents may come from teaching and research institutions in France or abroad, or from public or private research centers.

L'archive ouverte pluridisciplinaire **HAL**, est destinée au dépôt et à la diffusion de documents scientifiques de niveau recherche, publiés ou non, émanant des établissements d'enseignement et de recherche français ou étrangers, des laboratoires publics ou privés.

Title page**Title: Serotonin 2B receptors in mesoaccumbens dopamine pathway regulate cocaine responses****Abbreviated title: *Htr2b* in mesolimbic dopamine neurons****Authors:** Stéphane Doly^{1,7}, Emily Quentin¹, Raphaël Eddine², Stefania Tolu², Sebastian P. Fernandez^{1,8}, Jesus Bertran-Gonzalez^{1,9}, Emmanuel Valjent^{1,10}, Arnaud Belmer^{1,11}, Xavier Viñals⁵, Jacques Callebert⁴, Philippe Faure², Frank J. Meye¹, Denis Hervé¹, Patricia Robledo^{5,6}, Manuel Marnett^{1,12}, Jean-Marie Launay⁴, Rafael Maldonado^{5,6}, and Luc Maroteaux*¹**Author affiliations:** ¹INSERM, UMR-S839, F-75005, Paris, France; Sorbonne Universités, UPMC Univ Paris 06, UMR-S 839, F-75005, Paris, France; Institut du Fer à Moulin, F-75005, Paris, France.²Neuroscience Paris Seine NPS, CNRS UMR 8246 INSERM U1130, Paris, France; Sorbonne Universités, UPMC Univ Paris 06, UMR 7102, F-75005, Paris, France.⁴AP-HP, Hôpital Lariboisière, Service de Biochimie, Paris, 75010, France; INSERM U942, Paris, 75010, France.⁵Laboratory of Neuropharmacology, Department of Experimental and Health Sciences, University Pompeu Fabra. Barcelona, Spain.⁶Integrative Pharmacology and Systems Neuroscience, IMIM-Hospital del Mar Research Institute, Barcelona, Spain.***Corresponding author:** Luc Maroteaux INSERM, U839, Institut du Fer à Moulin, 17 rue du du Fer à Moulin 75005 Paris, France. TEL: (33) 01 45 87 61 23; FAX: (33) 01 45 87 61 32; Email: luc.maroteaux@upmc.fr.**Current addresses:** ⁷ Université Clermont Auvergne, INSERM, NEURO-DOL, F-63000 Clermont-Ferrand, France.⁸ IPMC – CNRS UMR7275 660 Route des Lucioles Sophia-Antipolis 06560 Valbonne France⁹ Clem Jones Centre for Ageing Dementia Research, Queensland Brain Institute, The University of Queensland, Brisbane, Queensland, Australia¹⁰ Institut de Génomique Fonctionnelle, INSERM U661; CNRS UMR 5203; University Montpellier I and II, Montpellier, France.¹¹ Translational Research Institute, Queensland University of Technology, Brisbane Qld 4059, Australia¹² Dept. Fundamental Neurosciences (DNF) The University of Lausanne, Rue du Bugnon 9 1005 Lausanne Switzerland**Number of words in abstract 204; Number of words in introduction 455; Number of words in discussion 1601; Number of figures 8; Number of pages 49.**

Conflict of interest

The authors declare no competing financial interests.

Acknowledgments

We thank the Mouse Clinical Institute (Strasbourg) for *Htr2b* floxed mice production, François Tronche and Mark Ungless for providing *Dat-Cre*^{+/⁰ mice, Evan Deneris for providing *Pet1-Cre*^{+/⁰ mice, Mythili Savariradjane and the Imaging facility of the IFM, Natacha Roblot from the IFM animal facility, and Imane Moutkine for excellent technical assistance.}}

This work was supported by Ministerio de Economía y Competitividad (#SAF2014-59648-P to R.M., MINECO/FEDER, UE); Instituto de Salud Carlos III (RD06/0001/0001 to R.M.) and (PI14/00210 to P.R.), FEDER funds; the Generalitat de Catalunya ICREA (Institució Catalana de Recerca i Estudis Avançats) Academia (2015) to R.M, and the studies on *Htr2b*^{-/-} mice were supported by funds from the *Centre National de la Recherche Scientifique*, the *Institut National de la Santé et de la Recherche Médicale*, the *Université Pierre et Marie Curie*, and by grants from the *Fondation pour la Recherche sur le Cerveau*, the *Fondation de France*, the *Fondation pour la Recherche Médicale* "Equipe FRM DEQ2014039529", the French Ministry of Research (Agence Nationale pour la Recherche ANR-12-BSV1-0015-01 and the Investissements d'Avenir programme ANR-11-IDEX-0004-02). S. Doly was supported by a Lefoulon-Lalande fellowship and E. Quentin by a PhD fellowship from the Region Ile de France DIM Cerveau et Pensée. LM's team is part of the École des Neurosciences de Paris Ile-de-France network and of the Bio-Psy Labex. None of these funding agencies had influence on the data presented in this paper.

Abstract:

Addiction is a maladaptive pattern of behavior following repeated use of reinforcing drugs in predisposed individuals, and leading to lifelong changes. A common substrate of these changes lies in alterations of neurons releasing dopamine in the ventral and dorsal territories of the striatum. The serotonin 5-HT_{2B} receptor has been involved in various behaviors including impulsivity, response to antidepressants and to psychostimulants pointing toward putative interactions with the dopamine system. Despite these findings, it remains unknown whether 5-HT_{2B} receptors directly modulate dopaminergic activity and the possible mechanisms involved. To answer these questions, we investigated the contribution of 5-HT_{2B} receptors to cocaine-dependent behavioral responses. Male mice permanently lacking 5-HT_{2B} receptors, even restricted to dopamine neurons, developed heightened cocaine-induced locomotor responses. Retrograde tracing combined with single cell mRNA amplification indicated that 5-HT_{2B} receptors are expressed by mesolimbic dopamine neurons. *In-vivo* and *ex-vivo* electrophysiological recordings showed that 5-HT_{2B}-receptor inactivation in dopamine neurons affects their neuronal activity and increases AMPA- over NMDA-mediated excitatory synaptic currents. These changes are associated with lower ventral striatum dopamine activity and blunted cocaine self-administration. These data identify the 5-HT_{2B} receptor as a pharmacological intermediate and provide mechanistic insight into attenuated dopamine tone following exposure to drugs of abuse.

Significance Statement

Here we report that mice lacking 5-HT_{2B} receptors totally or exclusively in dopamine neurons exhibit heightened cocaine-induced locomotor responses. In spite of the sensitized state of these mice, we found that associated changes include lower ventral striatum dopamine activity, and lower cocaine operant self-administration. We described the selective expression of 5-HT_{2B} receptors in

subpopulation of dopamine neurons sending axons to ventral striatum. An increased bursting *in-vivo* properties of these dopamine neurons and a concomitant increase in AMPA synaptic transmission to *ex-vivo* dopamine neurons was found in mice lacking 5-HT_{2B} receptors. These data support that the chronic 5-HT_{2B}-receptor inhibition makes mice behaving as animals already exposed to cocaine with higher cocaine-induced locomotion associated with changes in DA neuron reactivity.

Introduction

Serotonin (5-hydroxytryptamine, 5-HT) system is implicated in the establishment of drug use-associated behaviors via various receptors [For review see (Müller and Homberg, 2015)]. A common substrate of addictive behaviors lies in neurons releasing DA in the mesocorticolimbic system, as demonstrated via elegant and diverse investigations in both animals and humans (Hyman et al., 2006). This system comprises midbrain projections from the ventral tegmental area (VTA) and substantia nigra to cortical territories and subcortical limbic areas including the dorsal striatum and nucleus accumbens (NAcc). DA neurons can be regulated through 5-HT receptors expressed in VTA and NAcc (Hayes and Greenshaw, 2011). Both of these regions receive 5-HT projections from the dorsal raphe nucleus, which thereby can regulate DA neurotransmission (Di Giovanni et al., 2010). Cocaine binds with high affinity to the dopamine (DA), norepinephrine, and 5-HT transporters, blocks reuptake of these monoamines and increases their extracellular concentrations in the brain. 5-HT has also been shown to modulate cocaine action both in clinical and preclinical studies (Filip et al., 2010).

The 5-HT₂ receptors have been implicated as likely candidates for mediating the influence of 5-HT in cocaine abuse (De Deurwaerdere and Spampinato, 1999) as well as to traits (e.g., impulsivity) that contribute to the development of cocaine use disorder and relapse in humans [for review see (Howell and Cunningham, 2015)]. The role of 5-HT_{2B} receptors in cocaine addiction remains poorly understood. Recent pharmacological studies have shown that the injection of 5-HT_{2B}-receptor antagonists in rats had no effect on cocaine-induced DA outflow in the NAcc shell or core, or in the dorsal striatum (Devroye et al., 2015). In addition, the same group showed that 5-HT_{2B}-receptor antagonist treatment significantly reduced basal DA levels in the NAcc shell (Devroye et al., 2015), were devoid of effect in the dorsal striatum, and increased DA levels in the prefrontal cortex (PFC) (Devroye et al., 2016). They also showed that the preferential 5-HT_{1A}-receptor antagonist, WAY 100635, blocks the changes in PFC and NAcc basal DA levels induced by 5-HT_{2B}-receptor antagonists, supporting interplay between PFC 5-HT_{1A} and 5-HT_{2B} receptors (Devroye et al., 2017). Despite these findings, it remained unclear whether the 5-HT_{2B} receptor modulates at long term DA/reward system and the mechanisms involved.

Here, we report that mice with permanent genetic ablation even restricted to DA neurons, or long-term pharmacologic blockade (chronic antagonist treatment) of 5-HT_{2B} receptors exhibit heightened cocaine-induced locomotor responses. Associated changes include lower ventral striatum DA activity, and lower cocaine operant self-administration. Furthermore, a lack of this receptor increases the cocaine reactivity of VTA DA neurons projecting to the NAcc shell and the ratio of AMPA- over NMDA-mediated excitatory postsynaptic currents in these neurons. These data support that the 5-HT_{2B} receptor expressed by DA neurons is an intermediate in drug-evoked plasticity.

Materials and methods

Reagents.

Cocaine, SKF 81297 [(\pm)-6-chloro-7,8-dihydroxy-1-phenyl- 2,3,4,5-tetrahydro-1H-3-benzazepine hydrobromide] (Sigma-Aldrich, Saint-Quentin Fallavier, France), SB206553 [3,5-Dihydro-5-methyl-N-3-pyridinylbenzo[1,2-*b*:4,5-*b'*]dipyrrole-1(2*H*)-carboxamide], RS127445 [2-amino-4- (4-fluoronaphth-1-yl)-6-isopropylpyrimidine] and quinpirole hydrochloride (Tocris Bioscience, USA) were slowly dissolved in 0.9% (wt/vol) NaCl solution (saline). All drugs were administered intraperitoneally (ip) (0.1 ml/10 g body weight). RS127445 was found to have sub-nanomolar affinity for the 5-HT_{2B} receptor ($pK_i = 9.5 \pm 0.1$) and at least 1,000 fold selectivity for this receptor as compared to numerous other receptors and monoamine uptake sites (Diaz et al., 2012). Based on initial studies showing that RS127445 completely (at 1, 0.5, and 0.1 mg/kg; ip) or partially (at 0.05 mg/kg) blocked MDMA-induced locomotion in mice and had no effect on basal locomotor activity (Doly et al., 2008; Doly et al., 2009; Banas et al., 2011; Diaz et al., 2012), we used 1 (data not shown) or 0.5 mg/kg dose (ip) for the acute injection. Injections were administered 30 minutes before the test session in acute studies. *Htr2b*^{+/+} mice chronically treated with RS127445 continuously received the 5-HT_{2B} antagonist at 1 mg/kg/day or vehicle (10 mM DMSO) via subcutaneous (sc) osmotic pumps (Alzet® model 2004) for 4 weeks.

Animal studies

Animals. *Htr2b*^{-/-} mice (MGI:1888735) used in these experiments were maintained in a 129S2/SvPas (129S2) background. Wild type 129S2 mice (8-10 week old) used as a control group were derived from heterozygote crosses and were bred at our animal facility. Swiss-Webster mice carrying *drd2*-EGFP bacterial artificial chromosome transgenes were generated by the Gene Expression Nervous System Atlas program at Rockefeller University (MGI:3843608) (Gong et al., 2003). Initial experiments evaluating the cocaine responses were performed independently on small groups of males and females. Since no statistical difference was found between genders, later groups were composed of males for other experiments. All mice were maintained on a 12h light: 12h dark schedule (lights on at 8:00), and housed in groups of 3-5 of the same genetic background and sex after weaning. Mice were moved to experimental room in their home cage at least 5 days prior to testing to allow for habituation to the environment and stayed there until the end of experiments. Behavioral studies were carried out in the afternoon (14:00–20:00). The observer was blind to experimental conditions being measured. Behavioral tests and animal care were conducted in accordance with standard ethical guidelines (National Institutes of Health's 'Guide for the Care and Use of Laboratory animals', and European Directive 2010/63/ UE) and were approved by the local Ethic Committee for Animal Experiments (No. 01170.02).

Experimental design and statistical analysis

The total number of animals per group was defined according to the standard deviation and the difference score observed for each small group in a pilot experiment. Mice were randomly assigned to different experimental groups of 4 to 6 animals and independent experiments were performed at least 3 times. Normal distributions and homoscedasticity were verified by Shapiro-Wilk's test and Levene's test, respectively. Putative outliers were determined by the ROUT method. The statistical analysis was developed with the software Infostat and GrapPad Prism 6. Microdialysis and locomotor activity data were analyzed by two-way ANOVA repeated measures (RM) with gene or drug treatment and time as factors. Food and cocaine self-administration was analyzed by three-way ANOVA with hole, day and genotype as factors. Behavioral and biochemical assays were analyzed by two-way analysis of variance (ANOVA) with treatment and genotype as main factors. One-way

ANOVA or t-test and Bonferroni test were used for post-hoc comparisons depending on the experiment. $P < 0.05$ was predetermined as the threshold for statistical significance.

Generation of *Htr2b* floxed mice. Genomic contigs of *Htr2b* encompassing exon 1 and 2 and flanking sequence were obtained by screening of a 129S2 mouse genomic library. For the gene targeting construct, a 10 kb BamHI-XhoI fragment containing the two first exons was selected, while a 4 kb SacI-SacI fragment containing exon 2, which includes the ATG start codon and 5' UTR was used to induce the targeted deletion. A LoxP site was inserted in the 5'-UTR and a neomycin-resistance (NEO) cassette flanked by two LoxP sites in the ClaI site of the second intron. Then, the SacI-SacI fragment comprising the floxed construct was excised and electroporated into 129S2 embryonic stem (ES) cells which were subjected to G418 selection. Targeted homologous recombination was confirmed by PCR and Southern blot analysis. A positive ES clone was injected into C57Bl/6Ncrl blastocysts and implanted into pseudopregnant mice. A chimeric male displaying germ-line transmission was then used to propagate the floxed *Htr2b* (*Htr2b*^{fl/fl}) allele on a C57Bl/6Ncrl background for the two first generations. More than ten backcrosses of *Htr2b*^{fl/fl} mice with 129S2 (*Htr2b*^{+/+}) mice were performed. *Htr2b*^{fl/fl} alleles were detected by PCR using the oligonucleotide F1: CTAACATTTTTTCATCCACATCTA as forward primer located in the 5' UTR (position of the primers are indicated in Figure). Paired to this primer, the reverse primer R1: TCCCTCGAAGCTTATCGGCGCG, located in the 5' end of the second intron led to the amplification of a 1 kbp product in the presence of the *Htr2b*^{fl/fl} allele, while the reverse primer R2: ACTTTAATTGGGACTCGCTGAT, located in the 3' side of the ClaI site permits amplification of a 309 bp amplicon indicative of the *Htr2b* null allele.

DA neurons selective ablation of *Htr2b*. Adults *Htr2b*^{fl/fl} mice were exclusively inactivated in DA neurons for *Htr2b* by crossing with DAT-Cre⁺⁰ (BAC-Slc6-icre) mice (Turiault et al., 2007). *Htr2b*^{fl/fl};DAT-Cre⁺⁰ (*Htr2b*^{DAKO}) were generated on a mixed 129S2.B6 background used as F3 on 129S2 strain with littermate *Htr2b*^{fl/fl};DAT-Cre^{0/0} (*Htr2b*^{fl/fl}) as control mice. Identification of DA neurons was performed in *DAT-Cre*⁺⁰;Gt(ROSA)26Sor^{tm1.1(CAG-EGFP)Fsh} (*DAT-Cre*⁺⁰;RCE or *Dat-GFP*) mice, who expressed EGFP only after recombination [Jackson Lab, also named RCE:loxP mice harbor the R26R CAG-boosted EGFP (RCE) reporter allele with a *loxP*-flanked STOP cassette upstream of the enhanced green fluorescent protein (EGFP) gene-MGI:4412373].

Locomotor activity. Locomotor activity was measured in an actimeter (circular corridor with four infrared beams placed at every 90° Imetric, France) as described (Doly et al., 2009). Counts were incremented by consecutive interruption of two adjacent beams (i.e., mice moving through one-quarter of the corridor). Mice were individually placed in the activity box for 30 min followed by an ip injection of a saline solution and recorded for another 60 min during 3 days consecutively for habituation before all locomotor experiments. The day of experiment, mice were injected with a saline solution or 5-HT_{2B} antagonists (RS127445, 0.5 mg/kg or SB206553, 3 mg/kg) and individually placed in the activity box for 30 min before being ip injected with a saline or cocaine (7.5 to 20 mg/kg) solution and the locomotor activity was recorded for two hours.

Locomotor sensitization. For locomotor sensitization in this study, we used a two-injection protocol shown to be as efficient as repeated injections protocol but involving much less mice handling, thus minimizing stress and contextual habituation that can be confounding factors (Valjent et al., 2010). After 30 min in the actimeter, mice received a first injection of cocaine (7.5, 15 or 20 mg/kg) and the locomotor activity was recorded for two hours. Mice were then challenged seven days later with a

second injection of cocaine at the same concentration as the first injection, same injection protocol, and the locomotor activity was recorded for two hours.

Microdialysis in freely moving mice. The microdialysis experiment was performed using awake mice as described (Doly et al., 2009). Initially, anesthetized animals were placed in a stereotaxic frame (D. Kopf, Tujunga, CA, USA) and a stainless-steel guide cannula (CMA/12, CMA Microdialysis, North Chelmsford, MA, USA; outer diameter 0.7 mm) was implanted in the NAcc. The cannula was then secured to the skull with dental cement, and the skin was sutured. Animals were kept in individual cages for a seven-day recovery. Dialysis probes were equipped with a Cuprophan membrane (membrane length 1 mm and diameter 0.24 mm, cutoff: 5,000 Da, Microdialysis AB, Sweden). According to Praxinos and Franklin (2001), stereotaxic coordinates in mm were for NAcc AP +1.2, ML +0.6, DV -4.2 both to bregma and dura surface, respectively. After insertion, probes were perfused at a constant rate of 1 μ l/min with artificial CSF containing 154.1 mM Cl⁻, 147 mM Na⁺, 2.7 mM K⁺, 1 mM Mg²⁺, and 1.2 mM Ca²⁺, adjusted to pH 7.4 with 2 mM sodium phosphate buffer. The microdialysis experiment was performed using awake mice. Dialysates were collected every 20 min. All measurements were carried out 150 min after the beginning of perfusion, by which time a steady state was achieved. Mice were injected with cocaine (20 mg/kg; ip) 20 minutes after the beginning of measurements. At the end of the experiment, all brains were fixed in a 4% formaldehyde solution and serial coronal slices were made on a microtome. Histological examination of cannula tip placement was subsequently made on 100 μ m safranin-stained coronal sections. Dialysate samples were injected without any purification into an HPLC system that consists of a pump linked to an automatic injector (Agilent 1100, Palo Alto, CA, USA), a reverse-phase column (Zorbax SB C18, 3.5 μ m, 150 \times 4.6 mm; Agilent Technologies, Palo Alto, CA, USA) and a coulometric detector (Coulochem III; ESA Inc., Chelmsford, USA) with a 5011 analytical cell to quantify DA or 5-HT. The first electrode was fixed at -100 mV and the second electrode at +300 mV. The gain of the detector was set at 50 nA. The signal of the second electrode was connected to an HP Chemstation for HPLC. The composition of the mobile phase was 50 mM NaH₂PO₄, 0.1 mM Na₂EDTA, 0.65 mM octyl sodium sulphate and 14% (v/v) methanol, pH 3.5. The flow rate was set at 1 ml/min. The quantity of neurotransmitters calculated based on standard injected in each HPLC run in the same range of concentrations as experimental samples.

Tissue preparation and immunofluorescence. Ten minutes after cocaine or saline injection, and locomotor recording, mice were rapidly anesthetized with pentobarbital (500 mg/kg, ip; Sanofi-Aventis) and perfused transcardially with 4% (w/v) paraformaldehyde in 0.1 M sodium phosphate buffer, pH 7.5 (Bertran-Gonzalez et al., 2008). Brains were postfixed overnight in the same solution and stored at 4°C. Thirty- μ m-thick sections were cut with a Vibratome (Leica) and stored at -20°C in a solution containing 30% (v/v) ethylene glycol, 30% (v/v) glycerol, and 0.1 M sodium phosphate buffer, until they were processed for immunofluorescence. Free-floating sections were rinsed in Tris-buffered saline (TBS) (0.10 M Tris, 0.14 M NaCl), pH 7.4, incubated for 5 min in TBS containing 3% H₂O₂ (v/v) and 10% methanol (v/v), and rinsed three times 10 min in TBS. After 20 min incubation in 0.2% Triton X-100 in TBS (v/v), sections were rinsed three times in TBS, blocked with 30 g/L BSA in TBS, and incubated overnight (or longer as indicated) at 4°C with the primary antibodies. Antibody for TH is a mouse monoclonal (1:750 with an incubation \geq 2 d; Sigma-Aldrich) and for pERK using rabbit polyclonal antibodies against diphospho-Thr-202/ Tyr-204-ERK1/2 (1:400; Cell Signaling Technology). After incubation with primary antibody, sections were rinsed three times for 10 min in TBS and incubated for 45 min with chicken Cy3-coupled (1:400; The Jackson Laboratory) or goat Alexa Fluor 488-coupled (1:400; Invitrogen) secondary antibodies. Finally, sections were rinsed for 10 min twice in TBS and twice in Tris buffer (0.25 M Tris, pH 7.4)

before mounting in Vectashield (Vector Laboratories). Brain regions were identified using a mouse brain atlas and sections equivalent to 1.54 mm from Bregma were taken. Sections were processed as previously described (Doly et al., 2008). Confocal microscopy and image analysis were performed at the Institut du Fer à Moulin Imaging Facility. Labeled images from each region of interest were obtained bilaterally using sequential laser-scanning confocal microscopy (SP2; SP5 Leica). Neuronal quantification was performed in 375 x 375 μm images by counting nuclear/cytoplasm Cy3 immunofluorescence (for pERK1/2). Cell counts were performed by an observer unaware of the treatment received by the mice.

Food and cocaine self-administration. Prior to cocaine self-administration testing, mice were individually housed and food deprived to 85-90% of their free-feeding body weight, and then trained to respond for food pellets in mouse operant chambers (Med Associates Inc. Georgia, VT, USA) equipped with two nose-pokes, one randomly selected as the active and the other as the inactive nose-poke. A cue light located above the active nose-poke was paired contingently with the delivery of the reinforcer. Animals were first trained to respond for food pellets (Testdiet, Richmond, IN, USA) in one-hour daily self-administration sessions on a fixed ratio 1 (FR1) schedule of reinforcement until responding for food criteria was acquired (a minimum of 20 reinforcers, more than 75% of correct responding, and stabilization for 2 to 3 days) (see **Fig. 8a** for time scale of these experiments). After this initial training, mice were kept in ad libitum conditions in order to recover their body weight before proceeding with the catheter implantation as previously described (Soria et al., 2005). Mice were anesthetized with a mixture of ketamine/xylazine (5:1; 0.10 ml/10 g, ip) and implanted with indwelling intravenous silastic catheters on their right jugular vein as previously described (Soria et al., 2005). After surgery, animals were allowed to recover for 3 days before initiation of self-administration sessions. Saline solution self-administration sessions were performed until obtaining a low and stable responding pattern in order to prevent any food-seeking or food-extinction disturbance in succeeding cocaine self-administration. Mice were then trained to self-administer cocaine at the dose of 0.250 mg/kg/infusion during 8 days on a FR1 schedule of reinforcement, with a stability criteria set at a minimum of 5 cocaine infusions and 75% responding on the active nose-poke during 3 days. Following stable responding, all mice underwent dose-response experiments, where cocaine was presented at the doses of 0.125, and 0.500 mg/kg/infusion during 4 consecutive days respectively. Subsequently, a progressive ratio procedure was performed in order to test the motivation of the mice to work for cocaine at the dose of 0.125 mg/kg/infusion, where the response requirements to earn an infusion escalated according to the following series: 1-2-3-5-12-18-27-40-60-90-135-200-300-450-675-1000. The patency of intravenous catheters was evaluated at the end of the experiments by an infusion of 0.05 ml of thiopental sodium (5 mg/ml) (Braun Medical) through the catheter. If prominent signs of anesthesia were not apparent within 3 seconds of the infusion the mouse was removed from the experiment.

Sucrose preference. Sucrose preference was evaluated in the two-bottle choice test in individually caged *Htr2b*^{+/+} and *Htr2b*^{-/-} mice. In the first phase, two bottles of water were available during two consecutive days. Then, the liquid from one of the bottles was replaced with a 2% sucrose solution, and made available during 3 days. Total liquid intake, as well as, sucrose preference was determined by weighing the bottles once every morning.

Single-cell RT-PCR. Swiss-Webster mice carrying *Drd2-EGFP* bacterial artificial chromosome transgenes were generated by the Gene Expression Nervous System Atlas program at Rockefeller University (New York). For single-cell RT-PCR experiments, 1-2 week-old *Drd2-EGFP* mice were used to direct EGFP protein expression to D2 receptor expressing neurons. Mice were anesthetized

and decapitated, and the brain was rapidly dissected out. Horizontal slices (250- μ m thick) were prepared using a vibratome, in artificial cerebral spinal fluid aCSF supplemented with sucrose. After a 1-h recovery period, individual slices were placed in an electrophysiology chamber continuously perfused with aCSF bubbled with Carbogen and maintain at 22 °C. Neurons were visualized using an Olympus BX51WI upright microscope holding x5 and x40 objectives, a fluorescent lamp, and infrared, red, and green fluorescence filters. The methodology involving harvesting of cytoplasmic content and subsequent single cell PCR amplification has been described elsewhere (Cauli et al., 1997). Briefly, borosilicate glass pipettes (3-5 M Ω) were made in a HEKA PIP5 puller and filled with 8 μ l of autoclaved RT-PCR internal solution (in mM): 144 K-gluconate; 3 MgCl₂; 0.5 EGTA; 10 HEPES, pH 7.2 (285/295 mOsm). Single DA neurons in the VTA and SNc were approached with a pipette and after a whole-cell connection was established, cytoplasmic content of the cell was harvested by applying gentle negative pressure to the pipette. Cell content was expelled into a tube where a reverse transcription (RT) reaction was performed in a final volume of 10 μ l. Target cDNA sequences were thereafter amplified by conducting a multiplex nested PCR, designed to simultaneously detect the enzyme tyrosine hydroxylase (TH), D2 receptor and 5-HT_{2B} receptors. The following primers used were: TH, external sense CTGGCCTTCCGTGTGTTTCAGTG, external anti-sense CCGGCTGGTAGGTTTGATCTTGG, internal sense AGTGCACACAGTACATCCGTCAT and internal anti-sense GCTGGTAGGTTTGATCTTGGTA; D2 receptor external sense GCAGCCGAGCTTTCAGAGCC, external anti-sense CCTGCGGCTCATCGTCTTAAG, internal sense AGAGCCAACCTGAAGACACCAC and internal anti-sense CTTAAGGGAGGTCCGGGTTTTG; 5-HT_{2B} external sense CACTGGAGAAAAGGCTGCAGTA, external anti-sense TTGCACTGATTGGCCTGAATTG, internal sense GGCTATATGGCCCCTCCCAC and internal anti-sense GGTCCAGGGAAATGGCACAG.

Initially, all three genes were simultaneously amplified in a single tube using 10 μ l of cDNA, 200 nM of each primer and 2.5 U of Taq polymerase in a final volume of 100 μ l. The PCR reaction was carried out using a 6-min hot start at 94°C, followed by a 21-cycle program (94°C for 30 s, 60°C for 30 s and 72°C for 30 sec). Subsequently, 2 μ l of the amplified cDNA was used as the template for the second amplification step. Here, each gene was individually amplified in a separate tube, and a 35-cycles program using the same cycling conditions as mentioned above, in a final volume of 100 μ l. The products of the second PCR were analyzed by electrophoresis in 2.5% agarose gels using ethidium bromide. The sizes of the PCR-generated fragments were as predicted by the mRNA sequences and were further verified by direct sequencing of the final products.

***In-vivo* electrophysiology: extracellular single-cell recordings.** Mice were anesthetized with chloral hydrate, 400 mg/kg ip, supplemented as required to maintain optimal anesthesia throughout the experiment, and were positioned in a stereotaxic frame (David Kopf). Body temperature was kept at 37 °C by means of a thermostatically controlled heating blanket. Procedures for DA cell electrophysiological recording were described previously (Mameli-Engvall et al., 2006). An incision was made in the midline to expose the skull. A burr hole was drilled above the VTA (coordinates: between 3.5 \pm 0.3 mm posterior to bregma and 0.5 \pm 0.3 mm lateral to midline (Paxinos and Franklin, 2001). Recording electrodes were pulled with a Narishige electrode puller from borosilicate glass capillaries with outer and inner diameters of 1.50 and 1.17 mm, respectively (Harvard Apparatus Ltd.). The tips were broken under microscope control and filled with 1.5% Neurobiotine in 0.5% Na-acetate. These electrodes had tip diameters of 1–2 mm and impedances of 4–8 M Ω . They were lowered through the burr hole with a micro drive, and a reference electrode was placed in the subcutaneous tissue. Electrical signals were amplified by a high-impedance amplifier (Axon Instruments) and monitored visually with an oscilloscope (Tektronix TDS 2002) and audibly through

an audio monitor (A.M. Systems Inc.). When a single unit was well isolated, the oscilloscope sweep was triggered from the rising phase of the action potential and set sufficiently fast to display the action potential over the entire screen (usually 0.5 ms per unit). Such continuous observation of the expanded action potential provided assurance that the same single unit was being monitored throughout the experiment. The unit activity digitized at 25 KHz was stored in Spike2 program (Cambridge Electronic Design, CED, United Kingdom).

Firing Pattern Quantification. DA cell firing *in-vivo* was analyzed with respect to the average firing rate and the percentage of spikes within a burst (SWB) (the number of SWB divided by total number of spikes in a given window of 1-min duration; %SWB). DA cell firing *in-vivo* was analyzed with respect to the average firing rate and the %SWB. Neuron basal activity was defined on the basis of at least 5 min or 500 spikes. The electrophysiological characteristics of VTA neurons were analyzed in the active cells encountered by systematically passing the microelectrode in a stereotaxically defined block of brain tissue including the VTA. Its margins ranged from 2.92–3.88 mm posterior to bregma, 0.24–0.96 mm mediolateral with respect to the bregma point, and 3.7–4.7 mm ventral to the cortical surface, according to the coordinates of Paxinos and Franklin (2001). Sampling was initiated on the right side and then on the left side. Each electrode descent was spaced at least 10 μ m from the others.

DA cell identification. Extracellular identification of DA neurons was based on their location as well as on the set of unique electrophysiological properties that characterize these cells *in-vivo*: (i) a typical triphasic action potential with a marked negative deflection; (ii) a characteristic long-duration (>2.0 ms) action potential; (iii) an action potential width from start to negative of >1.1 ms; (iv) a slow firing rate (< 10 Hz) with an irregular single spiking pattern and occasional short, slow bursting activity. These electrophysiological properties distinguish DA from non-DA neurons. The mouse was killed with an overdose of anesthetic. The brain was removed and placed in a 4% paraformaldehyde solution. Sixty- μ m thick VTA sections were cut and stained with Neurobiotin and Tyrosine Hydroxylase antibody (a mouse monoclonal antibody for TH, 1:500 with an incubation 2>d; Sigma-Aldrich), and the recorded neurons were identified by fluorescence microscopy. We also added two criteria: (i) that the recording be stable (i.e., the absence of cell perturbation following our saline solution injection); and (ii) that the recorded cells be more than 4 mm from the surface of the brain. These parameters have been used classically to identify DA cells (Mameli-Engvall et al., 2006).

Electrophysiological response to cocaine and quinpirole. The firing rate and %SWB were evaluated using a 60-s moving window and a 15-s time step. Each cell activity was rescaled by its baseline value averaged during the 3-min period before 10 μ l cocaine (20 mg/kg) or quinpirole (0.25–0.50 mg/kg) in 0.9% NaCl was injected ip. For firing frequency, rescaling was defined using $x*100/x_b$ with x_b being the baseline firing frequency. The results are presented as mean \pm SEM. The effect of cocaine or quinpirole was tested by comparing the maximum observed during baseline and after cocaine injection. For each neuron we determined x_{av} , the maximum of the fluctuations before cocaine injections (during the 2.5-min period used as baseline); $x_{av} = \max(x)_{av} - \text{mean}(x)_{av}$, and x_{ap} is the maximum after cocaine (or quinpirole) injection (during the 3-min period after drug injection). We used a paired nonparametric Wilcoxon test (Wilcoxon signed rank test) to compare x_{av} and x_{ap} for firing frequency in two populations.

Electrophysiological recordings from brain slices. AMPA/NMDA ratio of evoked excitatory postsynaptic currents (EPSCs) from putative DA neurons of VTA were obtained with whole-cell

voltage-clamp recordings using a CsCl-based internal medium, as described (Glangetas et al., 2015). Six- to seven-week old *Htr2b*^{+/+} control and *Htr2b*^{-/-} mice were anesthetized (Ketamine/Xylazine) for slice preparation. Horizontal 250- μ m slices were prepared in bubbled ice-cold 95% O₂/5% CO₂-equilibrated solution containing (in mM): cholineCl 110; glucose 25; NaHCO₃ 25; ascorbic acid 11.6; Na⁺-pyruvate 3.1; KCl 2.5; NaH₂PO₄ 1.25; MgCl₂ 7; CaCl₂ 0.5, were then heated for 10 minutes in the same medium at 32°C. Subsequently, slices were stored at room temperature in 95% O₂/5% CO₂-equilibrated artificial cerebrospinal fluid (ACSF) containing (in mM): NaCl 124; NaHCO₃ 26.2; glucose 11; KCl 2.5; NaH₂PO₄ 1; CaCl₂ 2.5; MgCl₂ 1.3. Slices were kept at 32–34°C in a recording chamber and were continuously perfused with 2.5 ml/min ACSF. Whole-cell voltage-clamp recording techniques were used to measure excitatory synaptic responses of the ventral tegmental area (VTA). Synaptic currents were evoked by pulses (60 μ s) delivered at 0.1Hz through a glass pipette placed 200 μ m rostral to the patched neurons. Recordings were made in the presence of picrotoxin (100 μ M) to block GABA_A receptor-mediated currents. Putative DA neurons were identified as large cells (>30 pF capacitance) in the lateral part of the VTA, which are prone to project to the nucleus accumbens (Lammel et al., 2008). Currents were amplified, filtered at 5 kHz and digitized at 20 kHz and recorded at a holding potential of +40 mV (IGOR PRO, Wavemetrics, USA). Access resistance was monitored by a step of -4 mV (0.1 Hz) and experiments were discarded if the access resistance increased more than 20%. The internal solution contained (in mM): CsCl 130; NaCl 4; MgCl₂ 2; EGTA 1.1; HEPES 5; Na₂ATP 2; Na⁺-creatine-phosphate 5; Na₃GTP 0.6, and spermine 0.1, with a liquid junction potential of -3 mV. AMPA receptor (AMPA)-EPSCs were pharmacologically isolated using NMDA receptor (NMDAR) antagonist APV (50 μ M), while NMDAR-EPSCs were then calculated by subsequent digital subtraction. The ratio of AMPAR/NMDAR responses was calculated by taking the peak values of these averaged (20 sweeps) currents. All drugs were obtained from Abcam (Cambridge, UK), Tocris (Bristol, UK), and HelloBio (Bristol, UK). APV was dissolved in water, whereas picrotoxin was dissolved in DMSO (diluted 1000x in the final volume). Online/offline analysis was performed using IGOR-6 (Wavemetrics, USA) and Prism (Graphpad, USA). Compiled data are expressed as mean \pm SEM

Immunoblot analysis. Wild type and mutant mice (2-month-old, age-matched) were killed by decapitation and their brains were immediately dissected out from the skull and frozen on dry ice. Microdiscs of tissue were punched out from frozen slices (500- μ m thick) within the striatum using a stainless steel cylinder (1.4 mm diameter). Samples were homogenized in 1% SDS, equalized for their protein content and analyzed by western blot. The antibody dilutions were 1/1000 and 1/500 for antibodies against Golf and D1 receptor, respectively. Antibody for Golf was from our laboratory (Corvol et al., 2001) and for D1 receptor was from Luedtke et al. (1999). Antibodies were revealed by Fluoprobes 682 goat anti-rabbit or mouse IgG (Interchim, Montluçon, France) at a 1:5000 dilution. The fluorescent immunocomplexes were detected with Odyssey (LI-COR Biosciences, Lincoln, Nebraska). Quantification was carried out by measuring the average intensity in regions of interest using the Odyssey software and data were analyzed with the Prism 6 software (GraphPad Software, San Diego, CA).

Retrograde tracing of VTA or SNc neurons. *Drd2-EGFP* mice were anesthetized with ketamine (50 mg/kg) and xylazine (2 mg/kg) and fixed in a stereotaxic apparatus. Stereotaxically guided injections were made through holes in the dorsal surface of the cranium. Glass capillary tubes were pulled (HEKA pipette puller PIP5) and tips broken to 40 μ m diameter. Capillaries were filled with Dextran Alexa Fluor 568 (Invitrogen). Pressure injections of tracer (0.1 μ l for 10 min) were targeted to the NAcc (80 nl) or dorsal striatum (200 nl) for VTA or SNc neurons labeling, respectively. Micropipettes were left in place 10 min before removal to minimize leakage. The stereotaxic

coordinates used for these injections were obtained from the atlas (Paxinos and Franklin, 2001) adapted and checked in pilot experiments for P15 mice (NAcc AP +1, ML +0.6, DV -3.5; Dst AP +1, ML +1.5, DV -2 both to bregma and dura surface, respectively. Correct placement site was verified by red-dextran injection. After a 10 days survival, the animals were proceed for the single cell PCR experiment.

Binding assays. Mice were decapitated and brain regions, including the prefrontal cortex and striatum, were dissected on ice and homogenized with 25 ml of ice cold buffer containing 50mM Tris, 5mM MgCl₂, pH 7.4. Homogenates were centrifuged for 20 min at 15,000x g. The pellet was resuspended and centrifuged under the same condition three times. To the final suspension (0.2-0.6 mg/ml) was added for one hour, [³H]raclopride (81.3Ci/mmol; Perkin Elmer; USA) or [³H]SCH23390 (85.6Ci/mmol; Perkin Elmer; USA) (2 nM) for D2 and D1 receptors binding, respectively. The process was terminated by immersing the tubes in ice-cold buffer followed by rapid filtration through Whatman GF/B filters. Radioactivity was measured using liquid scintillation counting. Binding data were analyzed using the iterative non-linear fitting software GraphPad Prism 6 to estimate dissociation constants (K_D) and maximum number of sites (B_{max}).

Results

Permanent 5-HT_{2B}-receptor gene inactivation increases locomotor effects of cocaine. Locomotor activity recorded every 5 min was evaluated after an intraperitoneal (ip) injection of cocaine 30 min after the start of the session. Over the first 10 minutes, cocaine dose-dependently increased locomotor activity in *Htr2b*^{-/-} mice significantly more than in *Htr2b*^{+/+} mice (**Fig. 1a**) at every tested dose (multiple unpaired t-test, 7.5 mg/kg $t_{51} = 2.196$, $P=0.033$; 15 mg/kg $t_{51} = 3.407$, $P=0.0013$; 20 mg/kg $t_{51} = 4.619$, $P<0.0001$). We then evaluated in more details locomotor effects of cocaine injection at 7.5 and 15 mg/kg. A first injection of cocaine (7.5 mg/kg) induced a stronger increase in locomotor activity in *Htr2b*^{-/-} than *Htr2b*^{+/+} mice (**Fig. 1b**, two-way ANOVA RM, significant effect of genotype $F_{(1, 22)} = 6.04$, $p=0.022$ and time $F_{(18, 396)} = 23.80$, $p<0.0001$ with interactions $F_{(18, 396)} = 2.08$, $p=0.0061$). Bonferroni post-test showed a significant increase at 5, 20, and 25 min. Similar results were obtained with cocaine 15 mg/kg, (**Fig. 1c**, significant effect of genotype $F_{(1, 22)} = 5.22$, $p=0.032$ and time $F_{(18, 396)} = 23.93$, $p<0.0001$ with interactions $F_{(18, 396)} = 3.15$, $p<0.0001$). Bonferroni post-test showed a significant increase at 5-20 min. Behavioral sensitization can be measured by enhancement of drug-evoked locomotor responses following repeated drug exposure or injections performed a week apart (Stewart and Badiani, 1993; Valjent et al., 2010). Following a second cocaine injection, at the same dose, seven days after the first, *Htr2b*^{-/-} mice exhibited higher cocaine-induced locomotor response than *Htr2b*^{+/+} mice (7.5 mg/kg, **Fig. 1b**, significant effect of genotype $F_{(1, 22)} = 6.07$, $p=0.022$ and time $F_{(18, 396)} = 49.84$, $p<0.0001$ with interactions $F_{(18, 396)} = 5.42$, $p<0.0001$). Bonferroni post-test showed a significant increase at 5-20 min. Similar results were obtained with cocaine 15 mg/kg, (**Fig. 1c** significant effect of genotype $F_{(1, 22)} = 5.62$, $p=0.027$ and time $F_{(18, 396)} = 17.84$, $p<0.0001$ with interactions $F_{(18, 396)} = 3.22$, $p<0.0001$). Bonferroni post-test showed a significant increase at 5-20 min. The fold increase in cocaine induced-locomotor activity at the second injection with respect to the first was similar in both genotypes at either 7.5 or 15 mg/kg dose (7.5 mg/kg, **Fig. 1b**, unpaired t-test $t_{22} = 0.528$, $P=0.60$; 15 mg/kg, **Fig. 1c** unpaired t-test $t_{22} = 0.592$, $P=0.56$). Two-way ANOVA RM analysis of the total locomotor activity over 60 min showed significant effects of genotype and time of injection (7.5 mg/kg, **Fig. 1b**, main factors genotype $F_{(1, 22)} = 6.44$, $p=0.019$ and injection time $F_{(1, 22)} = 7.76$, $p=0.010$, no interactions $F_{(1, 22)} = 0.39$, $p=0.54$; 15 mg/kg, **Fig. 1c** main factors genotype $F_{(1, 22)} = 6.02$, $p=0.022$ and injection time $F_{(1, 22)} = 9.76$, $p=0.005$, no interactions $F_{(1, 22)} = 2.62$, $p=0.12$). Bonferroni post-test showed that total locomotor activity over 60 min after a 2nd injection was significantly higher in *Htr2b*^{-/-} compared to *Htr2b*^{+/+} mice and to the 1st injection. Interestingly, the locomotor activity at the first injection in *Htr2b*^{-/-} was similar to that at the second in sensitized *Htr2b*^{+/+} mice.

Permanent pharmacological 5-HT_{2B}-receptor blockade increases locomotor effects of cocaine.

We used ip injection of 5-HT_{2B} receptor antagonists in wild type mice to confirm these effects. A single ip injection of the highly selective and potent 5-HT_{2B} receptor antagonist, RS127445 (0.5 mg/kg) (Bonhaus et al., 1999), did not modified basal locomotion (**Fig. 2a**). Similar absence of differential effects was obtained with the 5-HT_{2B/2C}-receptor antagonist SB206553 (3 mg/kg) (**Fig. 2a**). Interestingly, we did not observe difference in cocaine-(15 mg/kg) induced locomotion in *Htr2b*^{+/+} mice after a single ip injection of RS127445 (0.5 mg/kg), compared to vehicle treated mice (**Fig. 2a**), or of the 5-HT_{2B/2C} receptor antagonist SB206553 (3 mg/kg) (**Fig. 2a**). We then evaluated whether the enhanced locomotor response to cocaine in *Htr2b*^{-/-} mice was developmentally mediated or due to long-term neuroadaptations following permanent inhibition of the receptor activity in adult *Htr2b*^{+/+} mice. A four-week treatment with RS127445 (1 mg/kg/d) by subcutaneous (sc) release with mini-osmotic pumps (Launay et al., 2002) in adult mice, did not modified basal locomotion (**Fig. 2b**). However, a four-week treatment with RS127445 (1 mg/kg/d) significantly enhanced cocaine-(15 mg/kg) induced locomotor response after a first injection (**Fig. 2b** two-way ANOVA RM,

significant effect of RS127445 $F_{(1, 14)} = 11.61$, $p=0.0042$ and time $F_{(18, 252)} = 21.12$, $p<0.0001$ with interactions $F_{(18, 252)} = 1.77$, $p=0.029$) compared to vehicle-treated mice. Bonferroni post-test showed a significant increase at 15, 20, and 30 min. A second cocaine injection, at the same dose seven days after the first, increased more the locomotion of chronically RS127445-treated $Htr2b^{+/+}$ than vehicle-treated $Htr2b^{+/+}$ mice (**Fig. 2b** two-way ANOVA RM, significant effect of RS127445 $F_{(1, 14)} = 25.19$, $p=0.0002$ and time $F_{(18, 252)} = 78.29$, $p<0.0001$ with interactions $F_{(18, 252)} = 8.32$, $p<0.0001$). Bonferroni post-test showed a significant increase at 5-30 min. The fold increase in cocaine induced-locomotor activity at the second injection with respect to the first was similar (**Fig. 2b** unpaired t-test $t_{14} = 0.808$, $P=0.43$). Two-way ANOVA RM analysis of the total locomotor activity over 60 min showed significant effects of genotype and time of injection (main effects of RS127445 $F_{(1, 14)} = 17.43$, $p=0.0009$ and injection time $F_{(1, 14)} = 31.59$, $p<0.0001$, no interactions $F_{(1, 14)} = 2.26$, $p=0.155$). Bonferroni post-test showed that total locomotor activity over 60 min after a 2nd injection was significantly higher in 4 weeks RS127445-treated compared to vehicle-treated $Htr2b^{+/+}$ mice and to the first injection. Together these results suggest that permanent inactivation of the 5-HT_{2B} receptor leads to increased sensitivity to cocaine as measured by locomotor responses, independently of putative consequences of the receptor knockout during embryonic development.

The lack of 5-HT_{2B} receptors reduces ventral striatal cocaine-induced DA outflow and ERK1/2 phosphorylation. To further investigate the consequences of the loss of 5-HT_{2B} receptor expression, we compared monoamine extracellular concentrations after cocaine injection in $Htr2b^{+/+}$ and $Htr2b^{-/-}$ mice first measured by microdialysis. In awake $Htr2b^{-/-}$ mice, a dose of cocaine (20 mg/kg), which increased locomotor activity (**Fig. 1a, 3b**), elicited a significantly lower increase (2.5-fold) in DA extracellular levels in the NAcc compared to $Htr2b^{+/+}$ mice, in which extracellular DA concentration increased 10-fold (**Fig. 3a**, two-way ANOVA RM, significant effect of genotype $F_{(1, 13)} = 43.29$, $p<0.0001$ and time $F_{(6, 78)} = 26.00$, $p<0.0001$ with interactions $F_{(6, 78)} = 1.77$, $p<0.0001$). Bonferroni post-test showed that cocaine-dependent DA level was significantly lower in $Htr2b^{-/-}$ compared to $Htr2b^{+/+}$ mice at 20-80 min. At the same dose, no difference in extracellular cocaine-dependent 5-HT accumulation in the NAcc was observed (**Fig. 3a**). Striatal extracellular signal-regulated kinase (ERK)1/2 phosphorylation is a marker of DA-dependent D1 receptor stimulation and an essential component of signaling pathways initiating synaptic plasticity and long-term behavioral effects of drugs of abuse (Girault et al., 2007). Cocaine injection (20 mg/kg) significantly increased locomotor activity for the first 10 minutes (**Fig. 3b**, two-way ANOVA, significant effect of genotype $F_{(1, 10)} = 9.23$, $p<0.0125$ and treatment $F_{(1, 10)} = 24.02$, $p=0.0006$ with interactions $F_{(1, 10)} = 9.06$, $p=0.013$). Bonferroni post-test showed that total locomotor activity over 10 min was significantly higher in $Htr2b^{-/-}$ compared to $Htr2b^{+/+}$ mice and to the vehicle injection. Ten minutes after cocaine injection, we quantified the number of phosphorylated-ERK1/2 (p-ERK1/2) immunoreactive neurons in various areas of the striatum of $Htr2b^{+/+}$ and $Htr2b^{-/-}$ mice (**Fig. 3c-e**). Activated neurons in vehicle and cocaine conditions displayed globally an equivalent amount of p-ERK1/2 staining, and immunoreactive areas of p-ERK1/2 (not illustrated). Two-way ANOVA, showed a significant effect of genotype $F_{(1, 10)} = 40.23$, $p<0.0001$ and treatment $F_{(1, 10)} = 234.2$, $p<0.0001$, with interaction between cocaine treatment and genotype ($F_{(1, 10)} = 36.34$, $p<0.0001$) only in NAcc shell (**Fig. 3e**). Bonferroni post-test showed that cocaine induced a significantly lower number in p-ERK1/2 immuno-positive neurons in the NAcc shell of $Htr2b^{-/-}$ than $Htr2b^{+/+}$ mice (4-fold vs. 10-fold). By contrast, the increase in the number of p-ERK1/2 immuno-positive neurons in NAcc core and dorsal striatum did not differ between genotypes (**Fig. 3e** two-way ANOVA, no effect of genotype in core $F_{(1, 10)} = 4.57$, $p=0.058$, or dorsal striatum, $F_{(1, 9)} = 1.705$, $p=0.22$). Bonferroni post-test showed p-ERK1/2 immuno-positive neurons were significantly increased by cocaine in both $Htr2b^{-/-}$ and $Htr2b^{+/+}$ mice. These results are in agreement with microdialysis data for whole NAcc. Altogether

these results suggest that reduced extracellular accumulation of DA blunts cocaine-dependent activation of the ERK1/2 pathway in medium spiny neurons of the NAcc shell from *Htr2b*^{-/-} mice without modification of activity in the dorsal striatum.

The lack of 5-HT_{2B} receptors increases locomotor effects of D1 agonist. Since cocaine-dependent ERK1/2 activation relies on D1 receptor-expressing striatal neurons, we assessed the locomotor response to D1 receptor agonist SKF81297 (2 mg/kg). Two-way ANOVA RM showed a significant effect of genotype ($F_{(1, 14)} = 5.30$ $p=0.037$) and time ($F_{(18, 252)} = 59.93$, $p<0.0001$) with interactions ($F_{(18, 252)} = 4.34$, $p<0.0001$) (**Fig. 4a**). Bonferroni post-test showed that SKF81297 increased locomotor activity significantly more in *Htr2b*^{-/-} than in *Htr2b*^{+/+} mice at 5-15 min. A second SKF81297 injection, seven days after the first, increased more locomotion in *Htr2b*^{-/-} than in *Htr2b*^{+/+} mice (**Fig. 4a** significant effect of genotype $F_{(1,14)} = 5.95$ $p=0.029$ and time $F_{(18, 252)} = 100.4$, $p<0.0001$ with interactions $F_{(18, 252)} = 5.58$, $p<0.0001$). Bonferroni post-test showed that SKF81297 increased locomotor activity significantly more in *Htr2b*^{-/-} than in *Htr2b*^{+/+} mice at 5-20 min. The fold increase in cocaine induced-locomotor activity at the second SKF81297 injection with respect to the first was similar in both genotypes (**Fig. 4a** unpaired t-test $t_{14} = 1.00$, $P=0.33$). Two-way ANOVA RM analysis of the total locomotor activity over 60 min showed significant effects of genotype and time of injection (**Fig. 4a** main effects of genotype $F_{(1, 14)} = 12.30$, $p=0.0035$ and of injection time $F_{(1, 14)} = 13.19$, $p=0.0027$ with no interactions $F_{(1,14)} = 0.057$, $p=0.82$). Bonferroni post-test showed that total locomotor activity over 60 min after a 2nd injection of SKF81297 was significantly higher in *Htr2b*^{-/-} compared to *Htr2b*^{+/+} mice and to the 1st injection. Nevertheless, basal expression of D1 and D2 receptors in *Htr2b*^{-/-} mice did not differ from *Htr2b*^{+/+} mice (**Fig. 4b,c**), and neither did *Gαolf* expression (**Fig. 4b,d**). Moreover, there was no difference in striatal DAT, SERT, NET expression between *Htr2b*^{+/+} and *Htr2b*^{-/-} mice (Doly et al., 2008; Banas et al., 2011; Diaz et al., 2012). These results suggest that D1 receptors are sensitized in *Htr2b*^{-/-} mice without modification of receptor, *Gαolf*, or transporter expression.

Meso-accumbens DA neurons express 5-HT_{2B} receptors. To understand how 5-HT_{2B} receptors could affect cocaine-induced effects in the NAcc, we evaluated their expression in VTA DA neurons. In the absence of reliable antibody against 5-HT_{2B} receptors in mice, we performed single-cell RT-PCR by extracting cytoplasmic RNA of single identified DA neurons expressing GFP from brain slices of *Drd2-EGFP* mice. We found that among D2- and tyrosine hydroxylase (TH)-positive neurons of the VTA, 40% expressed *Htr2b* mRNA (**Fig. 5a**). The two primary efferent fiber projections of DA neurons from VTA are the mesocortical and mesolimbic pathways, innervating the prefrontal cortex and NAcc, respectively (Lammel et al., 2014). We anticipated that among the VTA neurons expressing *Htr2b*, some would send projections to the NAcc and dorsal striatum. To visualize these cells, we stereotactically injected red-dextran into the NAcc shell (**Fig. 5b-d**) or dorsal striatum (**Fig. 5e,f**) of *Drd2-EGFP* mice and traced retrograde transport. We found that DA neurons projecting to the NAcc shell originated from the parabrachial pigmented area of the VTA (**Fig. 5c,d**), as previously reported (Ikemoto, 2007). Strikingly, by performing single cell RT-PCR on double-labeled neuron (**Fig. 5b**), we found that all double-labeled (*Drd2-EGFP* and NAcc shell-injected red-dextran) neurons expressed 5-HT_{2B} receptors ($n = 13$ out of 13). These data support a selective expression of 5-HT_{2B} receptors in mesolimbic DA neurons sending axons to NAcc shell.

The conditional knockout of 5-HT_{2B} receptor genes in DA neurons increases locomotor effects of cocaine. To functionally validate the 5-HT_{2B}-receptor expression in DA neurons, we generated conditional knockout mice by inserting recombination sites (loxP) flanking the *Htr2b* first coding exon (*Htr2b*^{fl/fl}) (**Fig. 6a-c**). We crossed mice expressing the Cre recombinase under a DA transporter

promoter (*Dat-Slc6a3*) (*Dat-Cre*⁺⁰) with these *Htr2b*^{fl/fl} mice, generating *Htr2b*^{DAKO}. We verified the proper recombination by colocalization of *Dat-GFP* with TH-positive DA neurons (**Fig. 6b,c**). A first injection of cocaine (20 mg/kg) induced a stronger increase in locomotor activity in *Htr2b*^{DAKO} mice than in control littermates *Htr2b*^{fl/fl} mice (**Fig. 6d** two-way ANOVA RM, significant effect of genotype $F_{(1, 18)} = 4.03$, $p=0.05$ and time $F_{(16, 288)} = 12.09$, $p<0.0001$ with interactions $F_{(16, 288)} = 3.27$, $p<0.0001$). Bonferroni post-test showed a significant increase in locomotion at 5-25 min. The locomotor effect of a challenge dose of cocaine seven days later (second injection) was also significantly enhanced in *Htr2b*^{DAKO} mice compared to *Htr2b*^{fl/fl} control mice (**Fig. 6d**, two-way ANOVA RM, significant effect of genotype $F_{(1, 18)} = 10.63$, $p=0.004$ and time $F_{(16, 288)} = 22.16$, $p<0.0001$ with interactions $F_{(16, 288)} = 4.90$, $p<0.0001$). Bonferroni post-test showed a significant increase at 5-30 min. The fold increase in cocaine induced-locomotor activity at the second injection with respect to the first was similar in both genotypes (**Fig. 6d** unpaired t-test $t_{18} = 0.324$, $P=0.75$). Two-way ANOVA RM analysis of the locomotion over 60 min showed significant effects of genotype ($F_{(1, 18)} = 10.31$, $p=0.0048$) and time of injection ($F_{(1, 18)} = 23.82$, $p=0.0001$) with interactions ($F_{(1,18)} = 3.74$, $p=0.069$). Bonferroni post-test showed that total locomotor activity recorded over 60 min after a 2nd injection was significantly higher in *Htr2b*^{DAKO} compared to *Htr2b*^{fl/fl} littermate mice and compared to the 1st injection (**Fig. 6d**). Thus, mice that underwent selective *Htr2b* inactivation in DA neurons display increased locomotor responses to cocaine. These data confirmed that inactivation of the receptor in DA neurons is, at least in part, responsible for locomotor effects and potentially for modulation of DA neuron activity observed in *Htr2b*^{-/-} mice.

The lack of 5-HT_{2B} receptors modulates VTA DA cell excitability. We next tested the hypothesis that 5-HT_{2B} receptors expressed by VTA DA neurons directly modulate activity of these neurons, first, by recording electrophysiological activity *in-vivo* in *Htr2b*^{+/+} and *Htr2b*^{-/-} mice. Mice were anesthetized and electrophysiologically active cells encountered in a stereotactically defined block of brain tissue including the VTA were recorded; only cells that met all criteria for VTA DA neurons were recorded: (i) a typical triphasic action potential with a marked negative deflection; (ii) a characteristic long-duration (>2.0 ms) action potential; (iii) an action potential width from start to negative of >1.1 ms; (iv) a slow firing rate (<10 Hz) with an irregular single spiking pattern (tonic) and occasional short, slow bursting (phasic) activity (Grace and Bunney, 1984b, a; Gonon, 1988; Mameli-Engvall et al., 2006). Juxtacellular single unit recordings were obtained in anesthetized *Htr2b*^{+/+} and *Htr2b*^{-/-} mice, respectively (**Fig. 7a**). Activity of DA cells was then characterized using the firing rate and the percentage of spikes within a burst (% SWB). DA cells fired at an average rate of 1.6 ± 0.2 Hz in *Htr2b*^{+/+} and 1.8 ± 0.1 Hz in *Htr2b*^{-/-} mice ($n = 57-58$). The mean percentage of burst firing in individual cells ranged from 0% to 16% in *Htr2b*^{+/+} and 0% to 60% in *Htr2b*^{-/-} mice, and was significantly higher in *Htr2b*^{-/-} ($5.2 \pm 1.5\%$) than *Htr2b*^{+/+} ($1.4 \pm 0.5\%$) mice (**Fig. 7a**, unpaired t-test-Welch corrected $t_{66} = 2.27$, $P=0.026$).

After baseline recordings, the same mice were ip injected with cocaine and the evoked modification of firing rate was analyzed. Cocaine (20 mg/kg) decreased the firing rate by 62.3% in *Htr2b*^{+/+} mice, while this decrease was significantly greater (90.9%) in *Htr2b*^{-/-} mice (**Fig. 7b**, unpaired t-test-Welch corrected $t_{16} = 2.73$, $P=0.015$). The decrease in firing rate lasted for more than 30 min after drug delivery and was not always followed by a return to pre-injection levels in *Htr2b*^{-/-} mice. However, systemic ip injection of the D2 agonist quinpirole (0.25-0.5 mg/kg) produced a similar decrease of firing rate in *Htr2b*^{+/+} and *Htr2b*^{-/-} mice (**Fig. 7c**). Our results indicate that long term blockade of 5-HT_{2B} receptor lead to a stronger cocaine-dependent inhibition of DA neurons firing rate and supports the hypothesis that 5-HT modulates VTA DA cell excitability via 5-HT_{2B} receptors without modification of D2 autoreceptor function.

To test whether the lack of 5-HT_{2B} receptors would produce long-lasting synaptic modifications in DA neurons, we used whole-cell patch recordings in acute brain slices. We measured AMPA- and NMDAR-mediated excitatory postsynaptic currents (EPSCs) in voltage clamp mode at +40 mV on horizontal brain slices, which included VTA from *Htr2b*^{+/+} and *Htr2b*^{-/-} mice, in DA neurons (large cells (>30 pF capacitance) from the lateral part of VTA that are prone to project to the NAcc shell. In *Htr2b*^{-/-}, the AMPA/NMDA ratio was significantly increased compared to control mice (*Htr2b*^{+/+}: 0.63 ± 0.06, n=7 cells; *Htr2b*^{-/-}: 1.01 ± 0.15, n=7 cells) (**Fig. 7d**, unpaired t-test $t_{12} = 2.35$, $P=0.037$). Altogether, these results indicated that the lack of 5-HT_{2B} receptors promotes an increase in DA neuron bursting *in-vivo* properties, a stronger reactivity to cocaine, and a concomitant potentiation of AMPA synaptic transmission of VTA DA neurons measured *ex-vivo*.

***Htr2b* inactivation modifies reinforcing properties of cocaine.** To know if locomotor activating effects of cocaine are associated with disruptions in primary reinforcing effects of the drug, we tested whether 5-HT_{2B}-receptor deletion altered operant cocaine self-administration. *Htr2b*^{+/+} and *Htr2b*^{-/-} animals were first trained to respond for food pellets under a fixed ratio (FR) 1 schedule of reinforcement, see (**Fig. 8a**) for self-administration experiments timeline. An increase in nose-poke responding was observed during the first sessions leading to a learning-curve pattern in both group of animals (day, $F_{(7, 203)} = 17.9$, $p<0.001$). Although active responding in *Htr2b*^{+/+} group was slightly higher, this difference was not significant (genotype, $F_{(1, 29)} = 0.8$, $p=0.36$) and the discrimination between active and inactive nose-poke responding was rapidly acquired by both *Htr2b*^{+/+} and *Htr2b*^{-/-} mice (**Fig. 8b**, hole, $F_{(1, 29)} = 144.4$, $p<0.001$). No statistical differences between genotypes were obtained when data from the acquisition days was analyzed ($F_{(1, 29)} = 2.7$, $p=0.112$) (**Fig. 8c**). Following catheter implantation, animals were tested on intravenous saline self-administration until responding rates decreased in order to avoid interference from food responding to cocaine self-administration. The mice included in the statistical analysis (18 *Htr2b*^{+/+} and 13 *Htr2b*^{-/-} mice) showed patent catheters up to the end of the experiment. Three-way repeated measures ANOVA analysis of the acquisition of cocaine (0.250 mg/kg/infusion) self-administration data showed a significant interaction between hole x day: ($F_{(7,203)} = 2.58$, $p<0.05$), but not between hole x genotype: ($F_{(1,29)} = 1.51669$, $p=0.228$), day x genotype: ($F_{(7,203)} = 0.69168$, $p=0.679$), or hole x day x genotype: ($F_{(7,203)} = 0.2108$, $p=0.983$) (**Fig. 8d**). Significant main effects of hole: ($F_{(1,29)} = 47.19$, $p<0.001$), day: ($F_{(7,203)} = 4.02$, $p<0.001$) and genotype ($F_{(1,29)} = 4.56$ $p<0.05$) were revealed. During the 8 days of acquisition training, 61% of WT and 38.5 % of KO mice met the stability criteria for cocaine self-administration at this dose. Cocaine intake (mg/kg) during the last 3 days of training at the dose of 0.25 mg/kg/infusion was not significantly different between genotypes (ANOVA: ($F_{(1,29)} = 1.61$, $p=0.213$) (**Fig. 8e**). Statistical analysis of cocaine dose-response results (**Fig. 8f**) showed that *Htr2b*^{-/-} mice earned a significantly lower number of cocaine infusions (genotype, $F_{(1, 29)} = 5.4$, $p<0.05$), especially at the dose of 0.125 (genotype, $F_{(1, 29)} = 6.3$, $p<0.05$) and 0.500 mg/kg/infusion (genotype, $F_{(1, 29)} = 4.2$, $p<0.05$) with respect to *Htr2b*^{+/+} mice. Although *Htr2b*^{-/-} animals obtained a lower breaking point in the progressive ratio schedule of reinforcement test (**Fig. 8g**), this difference was not significant (genotype, $F_{(1, 29)} = 2.1$, $p=0.162$). Finally, daily liquid intake was analyzed in *Htr2b*^{+/+} and *Htr2b*^{-/-} animals following self-administration experiments. Both groups of mice drank similar amounts of water during a 24 h period (genotype, $F_{(1, 29)} = 0.5$, $p=0.502$) (**Fig. 8h**), and both groups exhibited a comparable preference for sucrose-enriched water (genotype, $F_{(1, 29)} = 1$, $p=0.325$) (**Fig. 8i**). Although learning ability is similar in *Htr2b*^{-/-} mice to *Htr2b*^{+/+}, they self-administer less cocaine, show a trend toward lower breaking point, and display no difference in post-cocaine reward system.

Discussion

Here, we report that mice lacking 5-HT_{2B} receptors totally or exclusively in DA neurons exhibit heightened cocaine-induced locomotor responses. The lack of 5-HT_{2B} receptors induces a reduced cocaine-induced extracellular DA-accumulation. It also produces an over-reactivity of the NAcc shell medium spiny neurons to cocaine or D1 agonist, without any modification of DA signaling in the dorsal striatum. We describe the selective expression of 5-HT_{2B} receptors in VTA DA neurons sending axons to NAcc shell. An increase in basal DA neuron bursting *in-vivo* properties and a concomitant increase in AMPA synaptic transmission to VTA DA neurons measured *ex-vivo* were found in mice lacking 5-HT_{2B} receptors. The lack of 5-HT_{2B} receptors leads to a stronger inhibition of DA neurons firing rate in response to cocaine without modification of D2 autoreceptor function. Finally, the absence of 5-HT_{2B} receptors is associated with a decreased cocaine self-administration with a trend toward a lower breaking point in the progressive ratio schedule of reinforcement test. These data point toward the requirement of 5-HT via 5-HT_{2B} receptors to modulate both DA neurons and their targets.

DA and 5-HT interactions are known to be important in mesolimbic and nigrostriatal DA pathways. 5-HT immunoreactive fibers are dense in both VTA and SNc (Hervé et al., 1987). 5-HT_{2A} and 5-HT_{2C} receptors have previously been shown to modulate the effects of cocaine (Cunningham and Anastasio, 2014). We show, here, that genetic ablation of 5-HT_{2B} receptors, even restricted to DA neurons, increases cocaine-induced locomotor activity. However, acute pharmacologic inhibition does not reproduce this effect. These data are in agreement with previous neuropharmacological data indicating the inability of 5-HT_{2B} receptor antagonists to affect cocaine responses while acute blockade of 5-HT_{2A} and 5-HT_{2C} receptors generated opposing modulatory actions on cocaine-induced activity (Filip et al., 2010; Cunningham and Anastasio, 2014; Devroye et al., 2015). Nevertheless, we show here that a chronic (4 weeks) exposure to a 5-HT_{2B}-receptor antagonist is sufficient to increase the locomotor response to cocaine to the same extent as the increase observed in *Htr2b*^{-/-} mice. Aside of opposing actions of 5-HT_{2A} and 5-HT_{2C} receptors, 5-HT_{2B} receptors likely modulate directly and indirectly cocaine-induced locomotion via DA-dependent circuitry, since we found that 5-HT_{2B} receptors are expressed in VTA DA neurons projecting to the NAcc shell and that their selective elimination in DA neurons by conditional knockout is sufficient to reproduce the increased locomotor response to cocaine. It is clear that the 5-HT_{2B} receptor mode of action differs from that of 5-HT_{2A} and 5-HT_{2C} receptors and must affect different DA neuron subpopulation and/or different effectors.

One of our most striking finding is the dissociation between decreased cocaine-induced extracellular DA accumulation in NAcc associated to blunted activation of the ERK1/2 pathway selectively in medium spiny neurons of the NAcc shell, and increased locomotor activity. Cocaine, like other drugs of abuse, is known to preferentially increase extracellular DA in the NAcc shell as compared to the core (Di Chiara and Bassareo, 2007). This preferential action has also been demonstrated during acquisition of cocaine self-administration (Lecca et al., 2007). We identified that 100% of the retrogradely labeled DA neurons in the NAcc shell originating from VTA, express 5-HT_{2B} receptors. Interestingly, the reduced ERK1/2 activation of NAcc shell neurons following cocaine injection in *Htr2b*^{-/-} mice does not seem to take place in other striatal areas such as the core and dorsal striatum as indicated by the lack of effect on cocaine-induced increase of phosphorylated ERK1/2. The reduction of DA transmission in the NAcc shell upon cocaine injection may result from a heightened sensitivity to the inhibitory effect of cocaine on the firing of DA neurons projecting to the NAcc shell, since we observed that cocaine produced a stronger decrease in firing rate of VTA DA neurons in *Htr2b*^{-/-} mice. Recent pharmacological studies in rats have shown that acute 5-HT_{2B}-receptor antagonist injection had no effect on cocaine-induced DA outflow in the NAcc shell or core, or in the dorsal striatum (Devroye et al., 2015). However, these authors showed that an antagonist

injection reduced basal DA levels in the NAcc shell (Devroye et al., 2015), and was devoid of effect in the dorsal striatum (Devroye et al., 2016). These acute effects may be involved in neuroadaptions observed upon chronic antagonist exposure. Although, the cocaine dose of 0.25 mg/kg/infusion has reinforcing effects in *Htr2b*^{-/-} mice, the doses of 0.125 and 0.50 mg/kg/infusion do not. The fact that cocaine does not result in extracellular DA accumulation in the NAcc of these animals may underlie this observation. However there could also be DA-independent mechanism at work, possibly via 5-HT release, which is unchanged in *Htr2b*^{+/+} and *Htr2b*^{-/-} mice. Thus, the impaired 5-HT:DA balance could explain why *Htr2b*^{-/-} mice do not self-administer cocaine due to aversive properties of still-existing cocaine-evoked 5-HT release.

Furthermore, *Htr2c*^{-/-} mice display also increased sensitivity to locomotor stimulant effects of cocaine and exhibit enhanced cocaine-induced elevations of extracellular DA levels in the NAcc, but not in dorsal striatum (Rocha et al., 2002). The drug is more reinforcing in these mice. The 5-HT_{2C} receptor has been shown to be expressed in some VTA neurons, which synthesize and potentially release both DA and γ -aminobutyric acid (GABA) and project to the NAcc (Bubar et al., 2011). Since, we recently reported a dominance of 5-HT_{2C} over 5-HT_{2A} and 5-HT_{2B} receptors upon coexpression, which was also observed *in-vivo* (Moutkine et al., 2017), 5-HT_{2B}/5-HT_{2C} receptors heterodimerization may participate in some of these cocaine responses.

Another explanation to the dissociation between cocaine-induced decrease in DA accumulation, increase in locomotion, and reduction in cocaine self-administration is the increased post-synaptic responsiveness in other striatal areas. An important finding is the observation that a delay is necessary to allow adaptations that are responsible for these apparent paradoxical responses, the increased cocaine response being only an indirect consequence of 5-HT_{2B} receptor-dependent reduction in DA tone observed in NAcc and downstream adaptation. Our observation of sensitized locomotor response to D1 agonists in *Htr2b*^{-/-} mice may be the reason for the apparent discrepancy between reduction of DA transmission in the NAcc shell and increased locomotion. The trend in reduction of reinforcing properties of cocaine as indicated by reduction in breaking point for cocaine responding in a progressive ratio schedule is consistent with the reduction of DA stimulant effects of cocaine in *Htr2b*^{-/-} mice. These observations suggest that NAcc shell DA acting on D1 receptors (p-ERK findings) is critical for cocaine reinforcement. This conclusion is consistent with recent results obtained in rats, in which D1 receptors have been silenced by siRNA in the NAcc shell while sparing the core, and which were prevented from the acquisition of cocaine self-administration (Pisanu et al., 2015). Interestingly, excitatory afferents of VTA DA neurons that project to the NAcc are potentiated upon exposure of animals to addictive drugs (Lammel et al., 2012). This induction depends on NMDA and D1 receptors (Ungless et al., 2001), which are activated when DA neurons become active, releasing DA from their dendrites. The NMDARs that drive this induction are located on DA neurons themselves, supporting that this form of plasticity is a VTA-autonomous process. The ratio of the amplitude of AMPA/NMDA-mediated postsynaptic currents, a parameter often used to quantify synaptic strength in acute brain slice preparation, becomes higher than normal upon exposure to addictive drugs (Ungless et al., 2001). Here, we found that permanent ablation of 5-HT_{2B} receptors is associated with higher reactivity to cocaine of VTA DA neurons and higher AMPA/NMDA ratio. These data support that the 5-HT_{2B} receptor acts as an important factor preventing drug-evoked synaptic plasticity.

Previous evidence indicated that 5-HT_{2B} receptors could directly modulate 5-HT neurons and indirectly DA neurons. Indeed, genetic (knockout) or pharmacologic manipulation (antagonist) of 5-HT_{2B} receptors interferes with the effects of molecules that directly target the 5-HT system including serotonin selective reuptake inhibitors (SSRI) antidepressant, or amphetamine-derivatives 5-HT releasers MDMA and dexfenfluramine (Doly et al., 2008; Doly et al., 2009; Banas et al., 2011; Diaz et al., 2012). For example, the enhanced locomotor response to the psychostimulant MDMA was

abolished in *Htr2b*^{-/-} mice (Doly et al., 2008). These mutant mice did not exhibit behavioral sensitization or conditioned place preference following MDMA (10 mg/kg) injections as following injection of a 5-HT_{2B}-receptor antagonist (RS127445) in wild type mice. Nevertheless, high doses (30 mg/kg) of MDMA induce DA-dependent but 5-HT-independent behavioral effects (Doly et al., 2009). It was also reported that 5-HT_{2B} receptor selective antagonists can reduce significantly the DA outflow induced by amphetamine in the NAcc shell, but not in the dorsal striatum (Auclair et al., 2010). We independently found that *Htr2b*^{-/-} mice display a higher amphetamine-induced locomotion (Pitychoutis et al., 2015). Together with our present findings, these observations clearly distinguish between a direct action of 5-HT_{2B} receptors on 5-HT neurons that is mimicked by antagonists, from an action at DA neurons that requires long term inhibition of 5-HT_{2B} receptors and neuroadaptations i.e., that is not reproduced by direct antagonist injections. This finding is of importance for genetic polymorphisms that permanently affect gene expression such as the *HTR2B* (Gln20Ter) mutation (Bevilacqua et al., 2010).

Several parameters remain to be determined to fully explain our findings, e.g. the exact neural circuits that are modified, or the time during which blockade of 5-HT_{2B} receptor activity is necessary to produce the observed changes in reactivity to cocaine. Nevertheless, this work established for the first time that permanently inactive 5-HT_{2B} receptor is associated with a local hypodopaminergic that paradoxically and ultimately results in increased cocaine psychostimulant responses and a trend toward blunted motivation to the drug. To sum up, the chronic 5-HT_{2B}-receptor inhibition makes mice behaving as animals already exposed to cocaine with higher cocaine-induced locomotion associated with changes in DA neuron reactivity.

References

- Auclair AL, Cathala A, Sarrazin F, Depoortère R, Piazza PV, Newman-Tancredi A, Spampinato U (2010) The central serotonin 2B receptor: a new pharmacological target to modulate the mesoaccumbens dopaminergic pathway activity. *J Neurochem* 114:1323-1332.
- Banas S, Doly S, Boutourinsky K, Diaz S, Belmer A, Callebert J, Collet C, Launay J-M, Maroteaux L (2011) Deconstructing antiobesity compound action: requirement of serotonin 5-HT_{2B} receptors for dexfenfluramine anorectic effects. *Neuropsychopharmacology* 36:423-433.
- Bertran-Gonzalez J, Bosch C, Maroteaux M, Matamalas M, Herve D, Valjent E, Girault JA (2008) Opposing patterns of signaling activation in dopamine D1 and D2 receptor-expressing striatal neurons in response to cocaine and haloperidol. *J Neurosci* 28:5671-5685.
- Bevilacqua L, Doly S, Kaprio J, Yuan Q, Tikkanen R, Paunio T, Zhou Z, Wedenoja J, Maroteaux L, Diaz S, Belmer A, Hodgkinson C, Dell'Osso L, Suvisaari J, Coccaro E, Rose R, Peltonen L, Virkkunen M, Goldman D (2010) A population-specific HTR2B stop codon predisposes to severe impulsivity. *Nature* 468:1061-1066.
- Bonhaus DW, Flippin LA, Greenhouse RJ, Jaime S, Rocha C, Dawson M, Van Natta K, Chang LK, Pulido-Rios T, Webber A, Leung E, Eglén RM, Martin GR (1999) RS-127445: a selective, high affinity, orally bioavailable 5-HT_{2B} receptor antagonist. *Br J Pharmacol* 127:1075-1082.
- Bubar MJ, Stutz SJ, Cunningham KA (2011) 5-HT_{2C} receptors localize to dopamine and GABA neurons in the rat mesoaccumbens pathway. *PLoS ONE* 6:e20508.
- Cauli B, Audinat E, Lambollez B, Angulo MC, Ropert N, Tsuzuki K, Hestrin S, Rossier J (1997) Molecular and physiological diversity of cortical nonpyramidal cells. *J Neurosci* 17:3894-3906.
- Corvol JC, Studler JM, Schonn JS, Girault JA, Hervé D (2001) Galpha(olf) is necessary for coupling D1 and A2a receptors to adenylyl cyclase in the striatum. *J Neurochem* 76:1585-1588.
- Cunningham KA, Anastasio NC (2014) Serotonin at the nexus of impulsivity and cue reactivity in cocaine addiction. *Neuropharmacology* 76 Pt B:460-478.
- De Deurwaerdere P, Spampinato U (1999) Role of serotonin_{2A} and serotonin_{2B/2C} receptor subtypes in the control of accumbal and striatal dopamine release elicited in vivo by dorsal raphe nucleus electrical stimulation. *J Neurochem* 73:1033-1042.
- Devroye C, Cathala A, Di Marco B, Caraci F, Drago F, Piazza PV, Spampinato U (2015) Central serotonin_{2B} receptor blockade inhibits cocaine-induced hyperlocomotion independently of changes of subcortical dopamine outflow. *Neuropharmacology* 97:329-337.

- Devroye C, Cathala A, Haddjeri N, Rovera R, Vallee M, Drago F, Piazza PV, Spampinato U (2016) Differential control of dopamine ascending pathways by serotonin_{2B} receptor antagonists: New opportunities for the treatment of schizophrenia. *Neuropharmacology* 109:59-68.
- Devroye C, Haddjeri N, Cathala A, Rovera R, Drago F, Piazza PV, Artigas F, Spampinato U (2017) Opposite control of mesocortical and mesoaccumbal dopamine pathways by serotonin_{2B} receptor blockade: Involvement of medial prefrontal cortex serotonin_{1A} receptors. *Neuropharmacology* 119:91-99.
- Di Chiara G, Bassareo V (2007) Reward system and addiction: what dopamine does and doesn't do. *Current Opinion in Pharmacology* 7:69-76.
- Di Giovanni G, Esposito E, Di Matteo V (2010) Role of serotonin in central dopamine dysfunction. *CNS Neuroscience & Therapeutics* 16:179-194.
- Diaz SL, Doly S, Narboux-Nême N, Fernandez S, Mazot P, Banas S, Boutourlinsky K, Moutkine I, Belmer A, Roumier A, Maroteaux L (2012) 5-HT_{2B} receptors are required for serotonin-selective antidepressant actions. *Mol Psychiatry* 17:154-163.
- Doly S, Valjent E, Setola V, Callebert J, Herve D, Launay JM, Maroteaux L (2008) Serotonin 5-HT_{2B} receptors are required for 3,4-methylenedioxymethamphetamine-induced hyperlocomotion and 5-HT release in vivo and in vitro. *J Neurosci* 28:2933-2940.
- Doly S, Bertran-Gonzalez J, Callebert J, Bruneau A, Banas SM, Belmer A, Boutourlinsky K, Herve D, Launay JM, Maroteaux L (2009) Role of serotonin via 5-HT_{2B} receptors in the reinforcing effects of MDMA in mice *PLoS ONE* 4:e7952.
- Filip M, Alenina N, Bader M, Przegaliński E (2010) Behavioral evidence for the significance of serotonergic (5-HT) receptors in cocaine addiction. *Addiction Biology* 15:227-249.
- Girault JA, Valjent E, Caboche J, Herve D (2007) ERK2: a logical AND gate critical for drug-induced plasticity? *Curr Opin Pharmacol* 7:77-85.
- Glangetas C, Fois GR, Jalabert M, Lecca S, Valentinova K, Meye FJ, Diana M, Faure P, Mameli M, Caille S, Georges F (2015) Ventral Subiculum Stimulation Promotes Persistent Hyperactivity of Dopamine Neurons and Facilitates Behavioral Effects of Cocaine. *Cell reports* 13:2287-2296.
- Gong S, Zheng C, Doughty ML, Losos K, Didkovsky N, Schambra UB, Nowak NJ, Joyner A, Leblanc G, Hatten ME, Heintz N (2003) A gene expression atlas of the central nervous system based on bacterial artificial chromosomes. *Nature* 425:917-925.
- Gonon FG (1988) Nonlinear relationship between impulse flow and dopamine released by rat midbrain dopaminergic neurons as studied by in vivo electrochemistry. *Neuroscience* 24:19-28.
- Grace AA, Bunney BS (1984a) The control of firing pattern in nigral dopamine neurons: burst firing. *J Neurosci* 4:2877-2890.
- Grace AA, Bunney BS (1984b) The control of firing pattern in nigral dopamine neurons: single spike firing. *J Neurosci* 4:2866-2876.
- Hayes DJ, Greenshaw AJ (2011) 5-HT receptors and reward-related behaviour: a review. *Neurosci Biobehav Rev* 35:1419-1449.
- Hervé D, Pickel VM, Joh TH, Beaudet A (1987) Serotonin axon terminals in the ventral tegmental area of the rat: fine structure and synaptic input to dopaminergic neurons. *Brain Research* 435:71-83.
- Howell LL, Cunningham KA (2015) Serotonin 5-HT₂ receptor interactions with dopamine function: implications for therapeutics in cocaine use disorder. *Pharmacological Reviews* 67:176-197.
- Hyman SE, Malenka RC, Nestler EJ (2006) Neural Mechanisms of Addiction: The Role of Reward-Related Learning and Memory. *Annu Rev Neurosci* 29:565-598.
- Ikemoto S (2007) Dopamine reward circuitry: two projection systems from the ventral midbrain to the nucleus accumbens-olfactory tubercle complex. *Brain Res Rev* 56:27-78.
- Lammel S, Lim BK, Malenka RC (2014) Reward and aversion in a heterogeneous midbrain dopamine system. *Neuropharmacology* 76 Pt B:351-359.
- Lammel S, Hetzel A, Häckel O, Jones I, Liss B, Roeper J (2008) Unique properties of mesoprefrontal neurons within a dual mesocorticolimbic dopamine system. *Neuron* 57:760-773.
- Lammel S, Lim BK, Ran C, Huang KW, Betley MJ, Tye KM, Deisseroth K, Malenka RC (2012) Input-specific control of reward and aversion in the ventral tegmental area. *Nature* 491:212-217.
- Launay JM, Hervé P, Peoc'h K, Tournois C, Callebert J, Nebigil C, Etienne N, Drouet L, Humbert M, Simonneau G, Maroteaux L (2002) Function of the serotonin 5-hydroxytryptamine 2B receptor in pulmonary hypertension. *Nat Med* 8:1129-1135.
- Lecca D, Cacciapaglia F, Valentini V, Acquas E, Di Chiara G (2007) Differential neurochemical and behavioral adaptation to cocaine after response contingent and noncontingent exposure in the rat. *Psychopharmacology (Berl)* 191:653-667.

- Luedtke RR, Griffin SA, Conroy SS, Jin X, Pinto A, Sesack SR (1999) Immunoblot and immunohistochemical comparison of murine monoclonal antibodies specific for the rat D1a and D1b dopamine receptor subtypes. *J Neuroimmunol* 101:170-187.
- Mameli-Engvall M, Evrard A, Pons S, Maskos U, Svensson TH, Changeux J-P, Faure P (2006) Hierarchical control of dopamine neuron-firing patterns by nicotinic receptors. *Neuron* 50:911-921.
- Moutkine I, Quentin E, Guiard BP, Maroteaux L, Doly S (2017) Heterodimers of serotonin receptor subtypes 2 are driven by 5-HT_{2C} protomers. *J Biol Chem* 292:6352-6368.
- Müller CP, Homberg JR (2015) The role of serotonin in drug use and addiction. *Behav Brain Res* 277:146-192.
- Paxinos G, Franklin KBJ (2001) The mouse brain in stereotaxic coordinates. San Diego: Academic Press.
- Pisanu A, Lecca D, Valentini V, Bahi A, Dreyer J-L, Cacciapaglia F, Scifo A, Piras G, Cadoni C, Di Chiara G (2015) Impairment of acquisition of intravenous cocaine self-administration by RNA-interference of dopamine D1-receptors in the nucleus accumbens shell. *Neuropharmacology* 89:398-411.
- Pitychoutis P, Belmer A, Moutkine I, Adrien J, Maroteaux L (2015) Mice lacking the serotonin Htr2B receptor gene present an antipsychotic-sensitive schizophrenic-like phenotype. *Neuropsychopharmacology* 40:2764-2773.
- Rocha BA, Goulding EH, O'Dell LE, Mead AN, Coufal NG, Parsons LH, Tecott LH (2002) Enhanced locomotor, reinforcing, and neurochemical effects of cocaine in serotonin 5-hydroxytryptamine 2C receptor mutant mice. *J Neurosci* 22:10039-10045.
- Soria G, Mendizabal V, Tourino C, Robledo P, Ledent C, Parmentier M, Maldonado R, Valverde O (2005) Lack of CB1 cannabinoid receptor impairs cocaine self-administration. *Neuropsychopharmacology* 30:1670-1680.
- Stewart J, Badiani A (1993) Tolerance and sensitization to the behavioral effects of drugs. *Behav Pharmacol* 4:289-312.
- Turiault M, Parnaudeau S, Milet A, Parlato R, Rouzeau J-D, Lazar M, Tronche F (2007) Analysis of dopamine transporter gene expression pattern -- generation of DAT-iCre transgenic mice. *FEBS J* 274:3568-3577.
- Ungless MA, Whistler JL, Malenka RC, Bonci A (2001) Single cocaine exposure in vivo induces long-term potentiation in dopamine neurons. *Nature* 411:583-587.
- Valjent E, Bertran-Gonzalez J, Aubier B, Greengard P, Hervé D, Girault J-A (2010) Mechanisms of locomotor sensitization to drugs of abuse in a two-injection protocol. *Neuropsychopharmacology* 35:401-415.

Figure 1

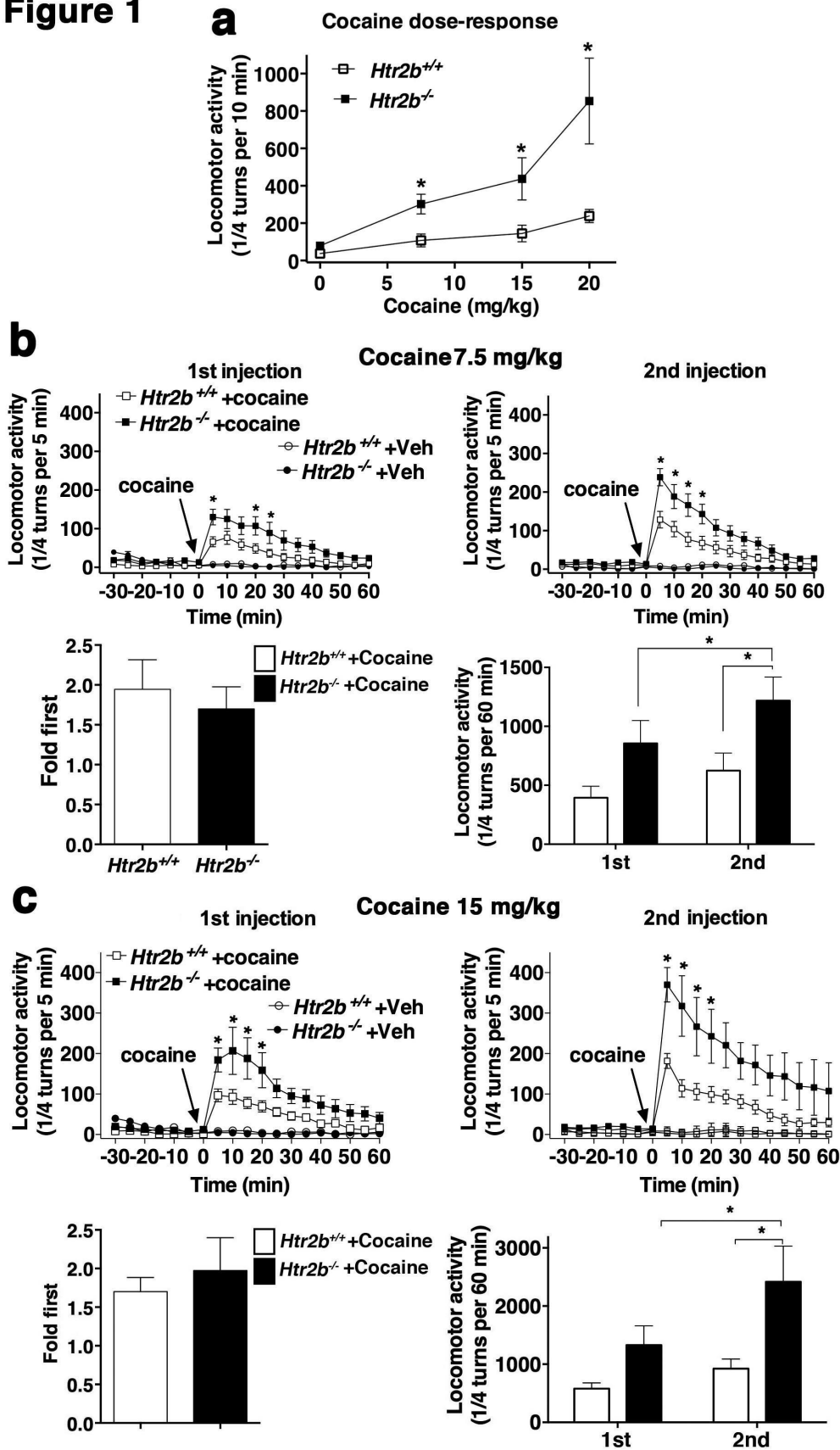

Fig. 1. Dose-dependent effects of 5-HT_{2B} receptor knockout on cocaine responses. a : Cocaine dose-dependent locomotor activity. The locomotor activity was recorded every 5 min. Cocaine was injected after 30 min of habituation. Over the first 10 minutes, cocaine dose-dependently increased the locomotor activity significantly more in *Htr2b*^{-/-} mice (black square) than in *Htr2b*^{+/+} mice (white square) (means ± SEM). Data were analyzed by multiple t-tests, (n= 8-8, vehicle; n = 8-9, cocaine 7.5 mg/kg; n = 9-9, cocaine 15 mg/kg; n = 3-5, cocaine 20 mg/kg; *P<0.05). **b : Higher locomotor response to cocaine injection (7.5 mg/kg) of *Htr2b*^{-/-} mice.** An injection of cocaine (7.5 mg/kg) increased significantly more the locomotor activity in *Htr2b*^{-/-} (cocaine, black square, n = 12) than in *Htr2b*^{+/+} mice (cocaine, white square, n = 12; 1st injection, left, arrow cocaine injection t = 0), while no locomotor difference was found following vehicle in *Htr2b*^{-/-} (black circle, n = 8) or in *Htr2b*^{+/+} (white circle, n = 8). Data were analyzed by two-way ANOVA repeated measures (RM). The stimulant locomotor effect of a challenge dose of cocaine seven days later (2nd injection, right, arrow cocaine injection t = 0) was significantly higher in *Htr2b*^{-/-} than in *Htr2b*^{+/+} mice, while no locomotor difference was found following vehicle in *Htr2b*^{-/-} or in *Htr2b*^{+/+} mice. The increase in cocaine induced-locomotor activity at the second injection was similar in respect to the first (Fold first) (left, n=12-12; unpaired t-test). Total locomotor activity recorded over 60 min after a 2nd injection (right) was significantly higher in *Htr2b*^{-/-} (black bars) compared to *Htr2b*^{+/+} mice (white bars) and to the 1st injection, as analyzed using two-way ANOVA RM for cocaine (means ± SEM, n = 12-12); Bonferroni post-hoc tests were applied to each graph, *P<0.05. **c : Higher locomotor response to cocaine injection (15 mg/kg) of *Htr2b*^{-/-} mice.** An injection of cocaine (15mg/kg) increased significantly more the locomotor activity in *Htr2b*^{-/-} (cocaine, black square, n = 12) than in *Htr2b*^{+/+} mice (cocaine, white square, n = 12) (1st injection, left, arrow cocaine injection t = 0), while no locomotor difference was found following vehicle in *Htr2b*^{-/-} (black circle, n = 8) or in *Htr2b*^{+/+} (white circle, n = 8) mice. Data were analyzed by two-way ANOVA RM. The stimulant locomotor effect of a challenge dose of cocaine seven days later (2nd injection, right, arrow cocaine injection t = 0) was also significantly higher in *Htr2b*^{-/-} compared to *Htr2b*^{+/+} mice, while no locomotor difference was found following vehicle in *Htr2b*^{-/-} or in *Htr2b*^{+/+} mice. The increase in cocaine induced-locomotor activity at the second injection was similar in respect to the first (Fold first) (left, n=12-12; unpaired t-test). Total locomotor activity recorded over 60 min after a 2nd injection (right) was significantly higher in *Htr2b*^{-/-} (black bars) compared to *Htr2b*^{+/+} mice (white bars) and to the 1st injection, as analyzed using two-way ANOVA RM (n = 12-12) (means ± SEM). Bonferroni post-hoc tests were applied to each graph, *P<0.05.

Figure 2

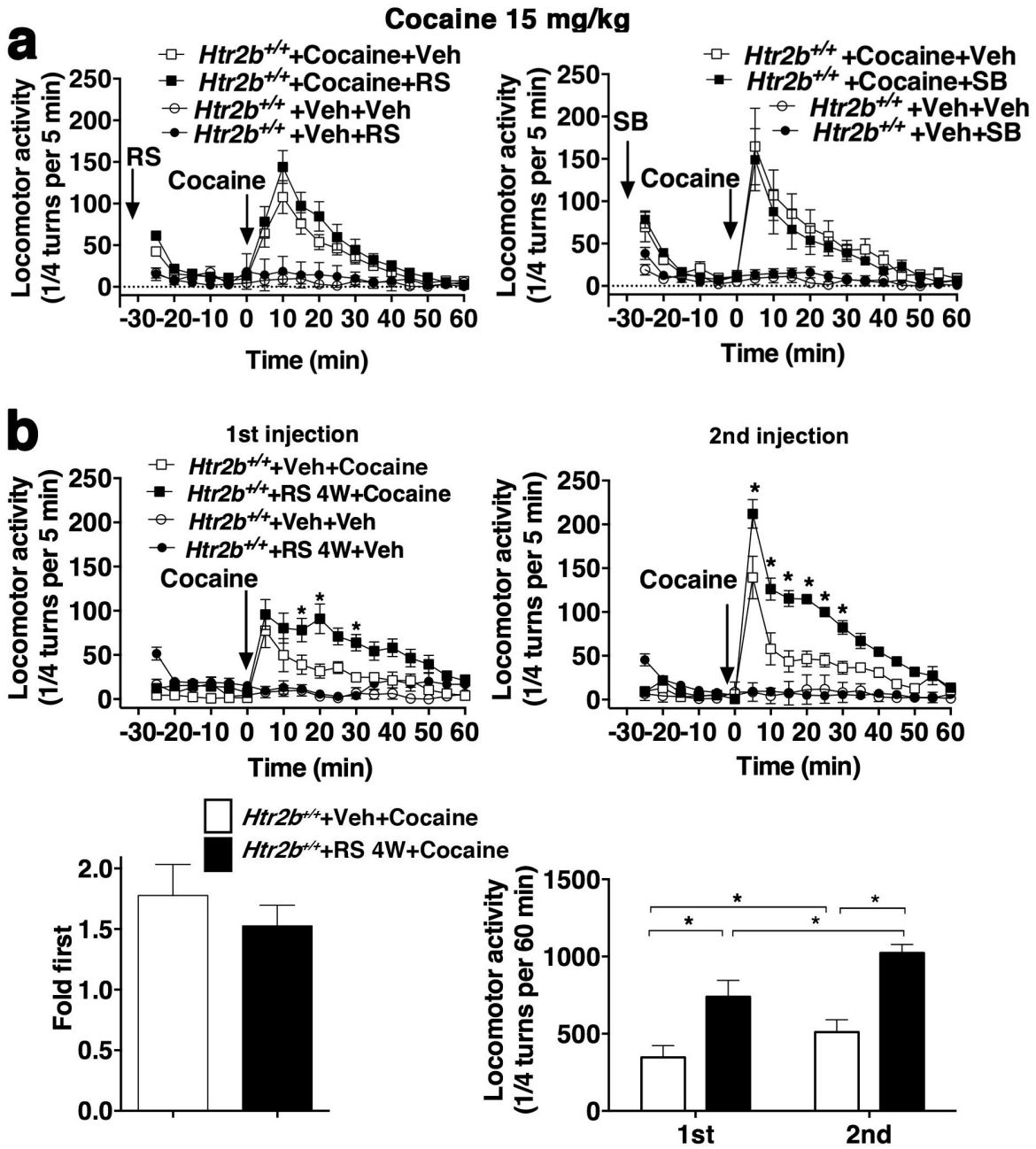

Fig. 2. Effects of 5-HT_{2B} receptor pharmacological blockade on cocaine response. a : Lack of effect of an injection of 5-HT_{2B} receptor antagonists on cocaine-induced locomotion. Locomotor activity was not different in response to saline vehicle (Veh-white circle, n = 8) or to a selective 5-HT_{2B} receptor antagonist (RS127445 0.5 mg/kg-RS, black circle, n = 8) (left) or after 15 mg/kg of cocaine ip co-injected with vehicle (Veh-white square, n = 12) or with RS127445 (0.5 mg/kg-RS, black square, n = 11) (left) in *Htr2b*^{+/+} mice. Similarly, no locomotor difference was found following saline vehicle (Veh-white circle, n = 7) or a 5-HT_{2B/2C} receptor antagonist (SB206553 3 mg/kg-SB) (right) (black circle, n = 7) or after 15 mg/kg of cocaine ip co-injected with vehicle (Veh-white square, n = 7) or with SB206553 (3 mg/kg-SB) (right) (black square, n = 7) in *Htr2b*^{+/+} mice. Data were analyzed using two-way ANOVA RM for cocaine (means ± SEM). **b : Mice exposed 4 weeks to RS127445 show increased locomotor responses to cocaine.** Locomotor activity was not different in response to saline vehicle (Veh-white circle, n = 8) or to 4 weeks RS127445-treated (RS127445 1 mg/kg-RS 4W, black circle, n = 7). However, an injection of cocaine (15 mg/kg) increased significantly more locomotor activity in 4 weeks RS127445-treated (cocaine, black square n = 8) than in vehicle-treated *Htr2b*^{+/+} mice (cocaine, white square, n = 8) (1st injection, left, arrow cocaine injection t = 0), as shown by two-way ANOVA RM. The stimulant locomotor effect of a challenge dose of cocaine seven days later was also significantly higher in 4 weeks RS127445-treated *Htr2b*^{+/+} mice (cocaine, black square, n = 8) (2nd injection, right, arrow cocaine injection t = 0) compared to vehicle-treated *Htr2b*^{+/+} mice (cocaine, white square, n = 8-8), while no locomotor difference was found following saline vehicle (Veh-white circle, n = 7) or a 4 weeks RS127445-treated (RS127445 1 mg/kg-RS 4W, black circle, n = 7). The increase in cocaine induced-locomotor activity at the second injection was similar in respect to the first (Fold first) (n = 8-8, left; unpaired t-test). Total locomotor activity recorded over 60 min after a 1st injection of cocaine and a 2nd injection (right) was significantly higher in 4 weeks RS127445-treated compared to vehicle-treated *Htr2b*^{+/+} mice and to the first injection, as analyzed using two-way ANOVA RM (n = 8-8) (means ± SEM). Bonferroni post-hoc tests were applied to each graph, *P<0.05.

Figure 3

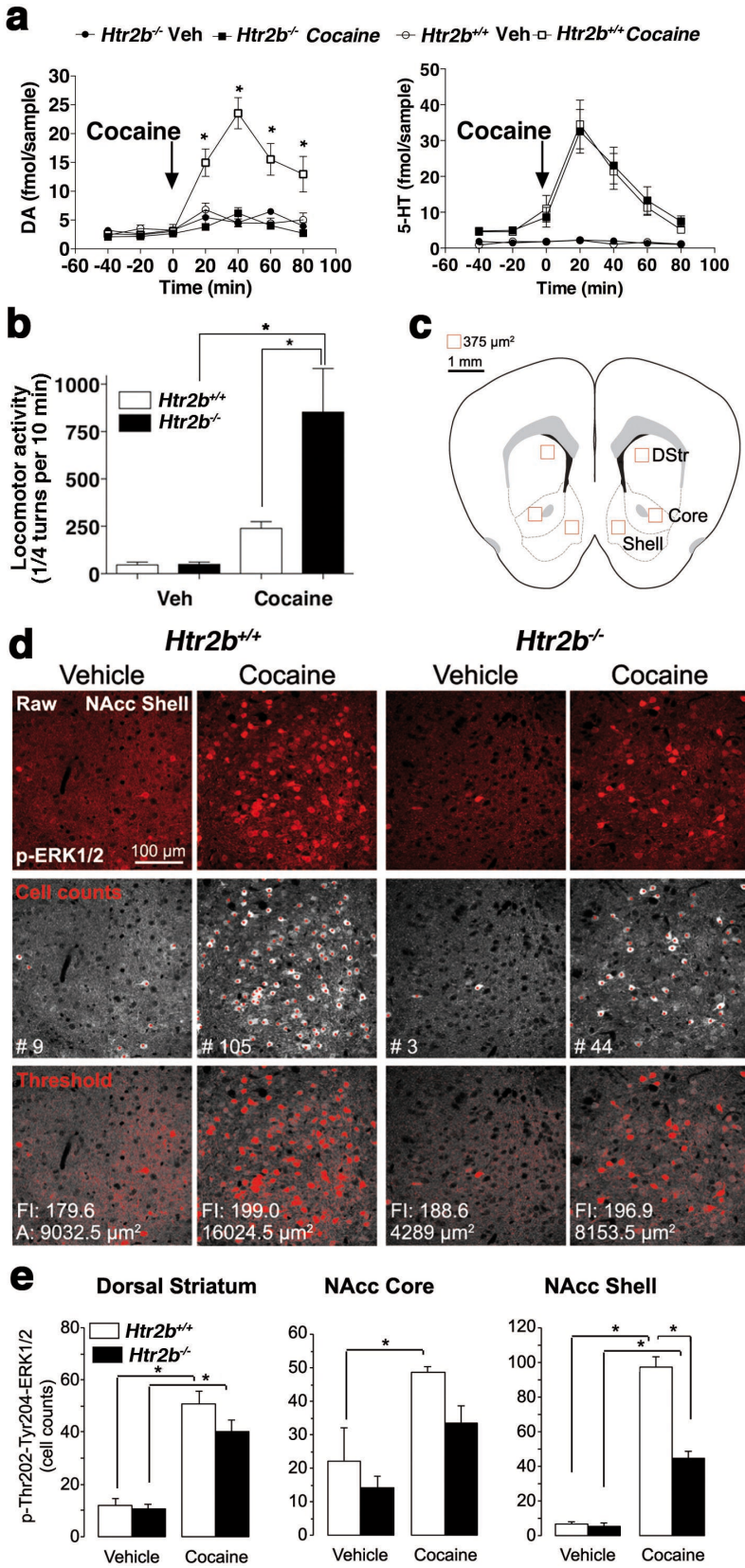

Fig. 3. Effect of 5-HT_{2B} receptor knockout on cocaine-dependent striatal activation. a : Lower extracellular DA but identical 5-HT accumulation in NAcc of cocaine-treated *Htr2b*^{-/-} mice. 5-HT and DA extracellular concentrations were assessed by microdialysis in the NAcc of awake mice. After cocaine (20 mg/kg) injection (t = 0), extracellular DA was significantly more elevated in *Htr2b*^{+/+} (white square, n = 7) compared to *Htr2b*^{-/-} (black square, n = 8) or saline control (black and white circle, n = 5-4) mice, as analyzed by two-way ANOVA RM. No difference in NAcc 5-HT extracellular concentrations in *Htr2b*^{+/+} (white square) and *Htr2b*^{-/-} (black square) mice, as analyzed using two-way ANOVA RM for cocaine (means ± SEM). Bonferroni post-hoc tests were applied to each graph, *P<0.05 vs. *Htr2b*^{+/+} cocaine. **b-g : Reduced ERK1/2 phosphorylation in ventral, but not in dorsal striatum of cocaine-treated *Htr2b*^{-/-} mice.** **b :** The locomotion was first recorded during the first 10 minutes after saline (vehicle) or cocaine (20 mg/kg) injection. Locomotor activity was significantly higher in *Htr2b*^{-/-} (black square) than in *Htr2b*^{+/+} mice (white square), as analyzed using two-way ANOVA (n = 3-5) (means ± SEM). Bonferroni post-hoc tests were applied to each graph, *P<0.05. Immediately after the 10 min of locomotor recording, the brains were fixed and sectioned. p-ERK1/2 immuno-positive neurons were counted. **c :** location of the images within the striatal tissue (red squares). **d :** raw images obtained in the confocal microscope (top panels), cell counts performed on each image (middle panels, red dots) and segmentation on each image through signal thresholding (bottom panels). **e :** quantification revealed significantly lower number of cells positive for p-ERK1/2 in the NAcc shell of cocaine-treated *Htr2b*^{-/-} (black) compared to *Htr2b*^{+/+} (white) mice (n = 3-4 mice), as analyzed using two-way ANOVA. No difference between genotype was found in NAcc core or dorsal striatum. Bar scales: 100 μm. Bonferroni post-hoc tests were applied to each graph, *P<0.05.

Figure 4

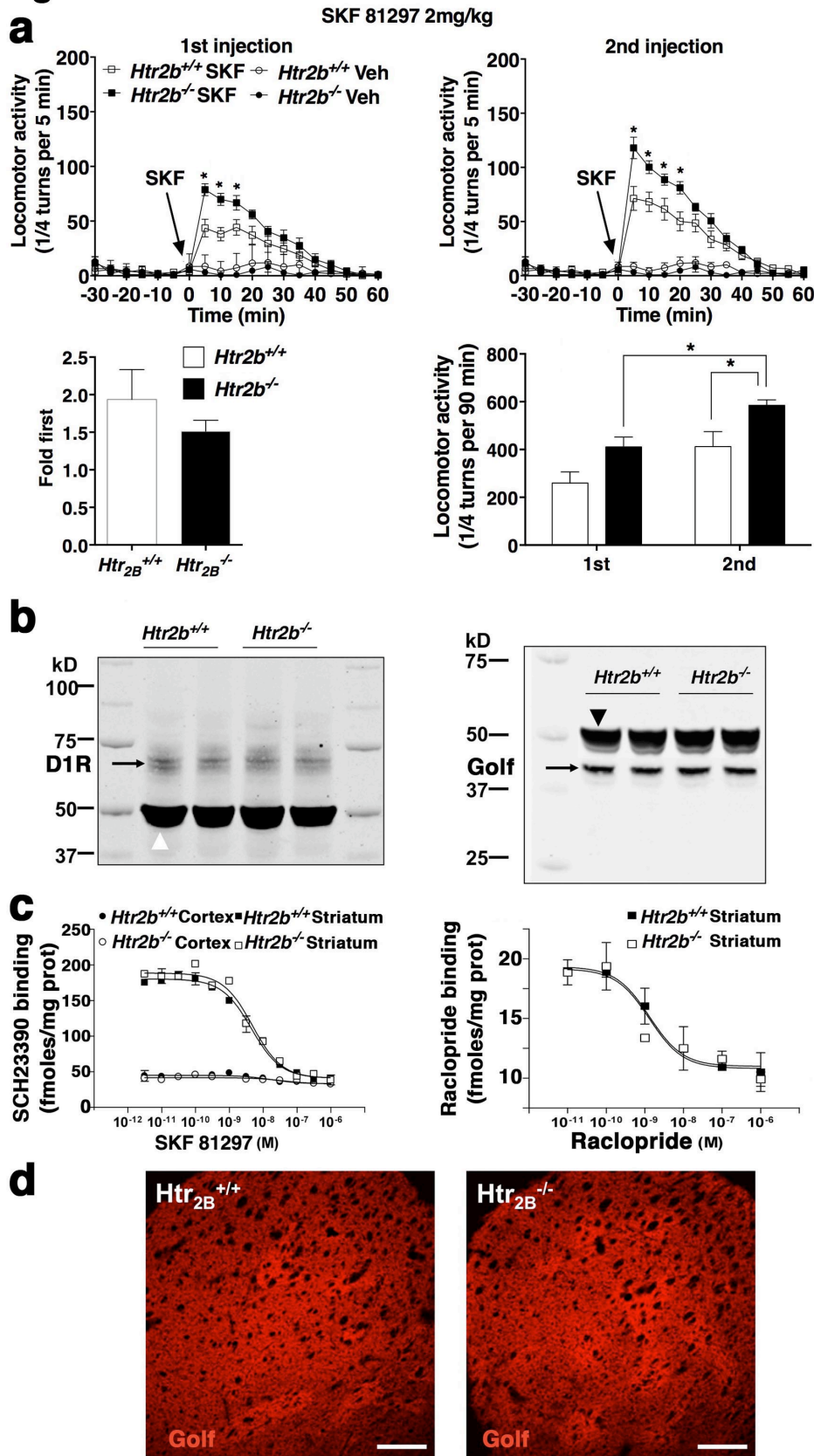

Fig. 4. Assessment of DA system in *Htr2b*^{-/-} mice. a : Increased locomotor activity in response to DA receptor D1 agonist in *Htr2b*^{-/-} mice. An ip injection of D1 agonist SKF81297 (SKF, 2mg/kg) increased significantly more the locomotor activity in *Htr2b*^{-/-} (SKF, black square, n = 8) than in *Htr2b*^{+/+} mice (SKF, white square, n = 8; 1st injection, left, arrow cocaine injection t = 0), while no locomotor difference was found following vehicle in *Htr2b*^{-/-} (Veh-black circle, n = 8) or in *Htr2b*^{+/+} (Veh-white circle, n = 8), as analyzed using two-way ANOVA RM. The stimulant effect of a challenge dose of SKF81297 seven days later (2nd injection, right, arrow cocaine injection t = 0) was also significantly higher in *Htr2b*^{-/-} (SKF, black square, n = 8) compared to *Htr2b*^{+/+} mice (SKF, white square, n = 8; 2nd injection, left, arrow cocaine injection t = 0), while no locomotor difference was found following vehicle in *Htr2b*^{-/-} (Veh-black circle, n = 8) or in *Htr2b*^{+/+} (white circle, n = 8). The increase in SKF81297 induced-locomotor activity at the second injection was similar in respect to the first (Fold first) (left, n = 8-8; unpaired t-test). Total locomotor activity recorded over 60 min after a 2nd injection (right) was significantly higher in *Htr2b*^{-/-} (black bars) compared to *Htr2b*^{+/+} mice (white bars) and to the 1st injection, as analyzed using two-way ANOVA RM for cocaine (means ± SEM, n = 8-8). Bonferroni post-hoc tests were applied to each graph, *P<0.05. **b-d Similar D1 and D2 receptor expression level in *Htr2b*^{+/+} and *Htr2b*^{-/-} mice.** **b**, Western blots from *Htr2b*^{+/+} and *Htr2b*^{-/-} mouse striatum proteins (2 examples for each genotype) were revealed using antibody against D1 receptor (left, black arrow) or using Gaolf antibody (right, black arrow). Normalization (using tubulin antibody; arrow head) revealed no significant difference between genotypes (n = 4 mice per genotype; Student's t-test). **c**, Radioligand binding assays with the selective D1 receptor ligand [³H]SCH23390 on membranes prepared from cortex and striatum showed no differences between *Htr2b*^{+/+} and *Htr2b*^{-/-} mice (Bmax = *Htr2b*^{+/+} cortex 18±2.7; *Htr2b*^{-/-} cortex 14±2.5; *Htr2b*^{+/+} striatum 211 ± 6; *Htr2b*^{-/-} striatum 223 ± 7.4 fmoles/mg of proteins) (left). Radioligand binding assays with the selective D2 receptor ligand [³H]raclopride on membranes prepared from striatum showed no differences between *Htr2b*^{+/+} and *Htr2b*^{-/-} mice (Bmax = *Htr2b*^{+/+} striatum 11.4 ± 5.6; *Htr2b*^{-/-} striatum 11.4 ± 5.7 fmoles/mg of proteins, 3 independent experiments in duplicate) (right). **d**, Immunohistochemistry with a selective antibody directed against Gaolf protein on striatum slices showed no pattern differences between *Htr2b*^{+/+} and *Htr2b*^{-/-} mice, respectively, (scale bars: 200 µm).

Figure 5

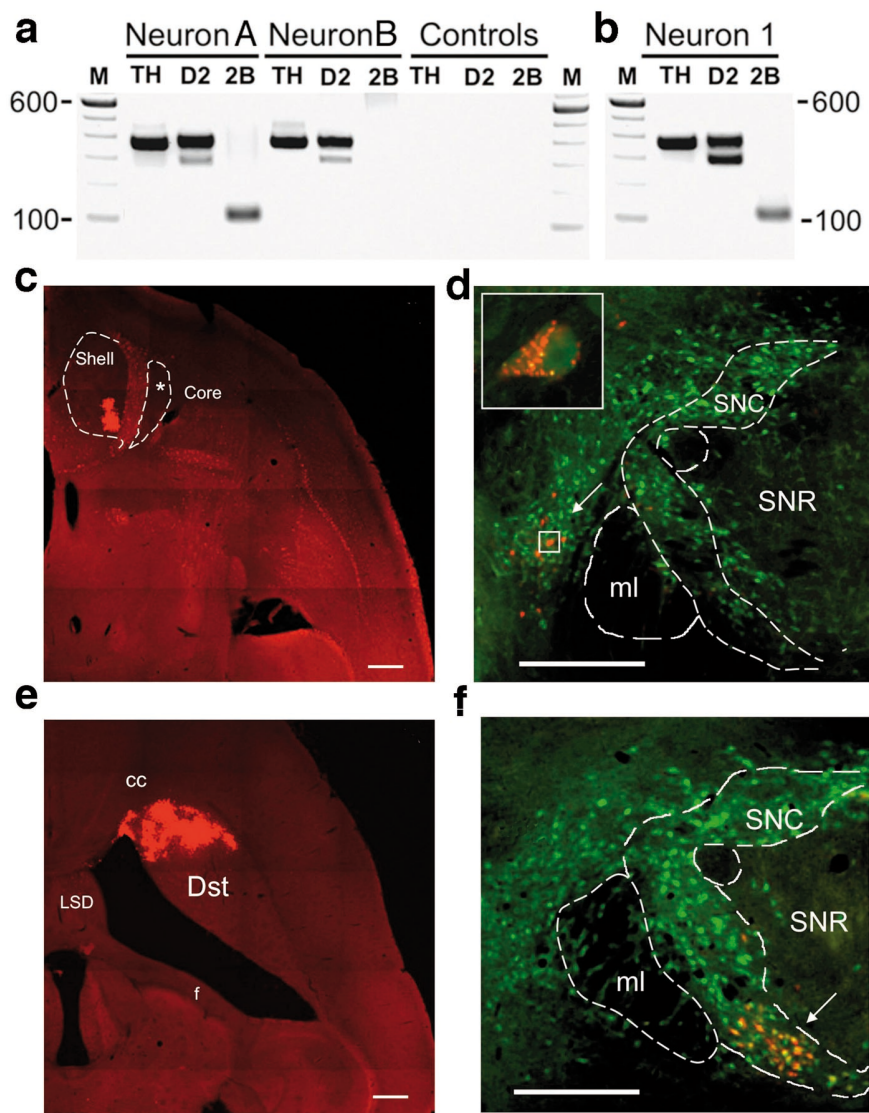
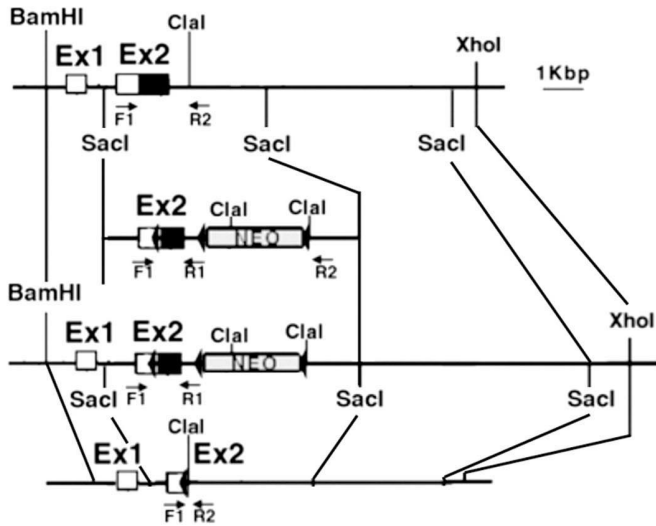

Fig. 5. 5-HT_{2B} receptors are expressed by mesolimbic DA neurons. a : Coexpression of D2 receptors and tyrosine hydroxylase with 5-HT_{2B}-receptor mRNA in a subset of individual VTA neurons. RT-PCR was performed on cytoplasmic RNA extracted from individually identified *Drd2-EGFP*-positive VTA neurons. The displayed pattern illustrates a negative (Neuron B) and a positive neuron (Neuron A) expressing 5-HT_{2B} receptor, which is representative of 4 out of 10 neurons in VTA. All neurons classes express tyrosine hydroxylase (TH) and D2 receptors (D2). Negative RT-PCR controls (GFP negative neuron) are also presented. M = molecular weight marker in base pairs.

b-d : VTA neurons expressing 5-HT_{2B} receptor project to the NAcc. b, Stereotactic red-dextran injection in NAcc of *Drd2-EGFP* mice allowed identifying, after retrograde tracing, VTA DA neurons projecting to NAcc (double-labeled). Cytoplasmic RNA from double labeled neuron in the VTA was analyzed by single cells RT-PCR (Neuron 1), which is representative of 13 out of 13 VTA neurons expressing 5-HT_{2B} receptor and that project to NAcc. **c,** Representative horizontal section, showing NAcc shell stereotactic red-dextran injection site for retrograde tracing experiments using fluorescently red-labeled latex beads. Scale bars: 600 μm **d,** Representative horizontal section, showing red-dextran retrograde tracing in VTA of *Drd2-EGFP* mice that identified double-labeled DA neurons projecting to NAcc used for single cells RT-PCR (Arrow and inset). Scale bars: 200 μm . Star indicates the NAcc core nucleus. **e-f Controls of red dextran injection into dorsal striatum. e,** Representative horizontal section, showing dorsal striatum stereotactic red-dextran injection site for retrograde tracing experiments using fluorescently red-labeled latex beads. Scale bars: 600 μm **f,** Representative horizontal section, showing red-dextran retrograde tracing in the *substantia nigra reticulata* (SNR) of *Drd2-EGFP* mice that identify DA neurons projecting to dorsal striatum (Arrow). Scale bars: 200 μm . SNR: *substantia nigra reticulata*; SNC *substantia nigra compacta*; ml: medial lemniscus; Dst: dorsal striatum; f: fornix; cc: *corpus callosum*; LSD: lateral septal nucleus dorsal.

Figure 6

a



b

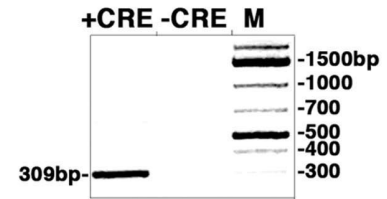

c

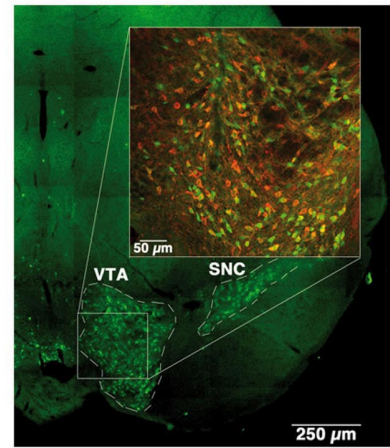

d

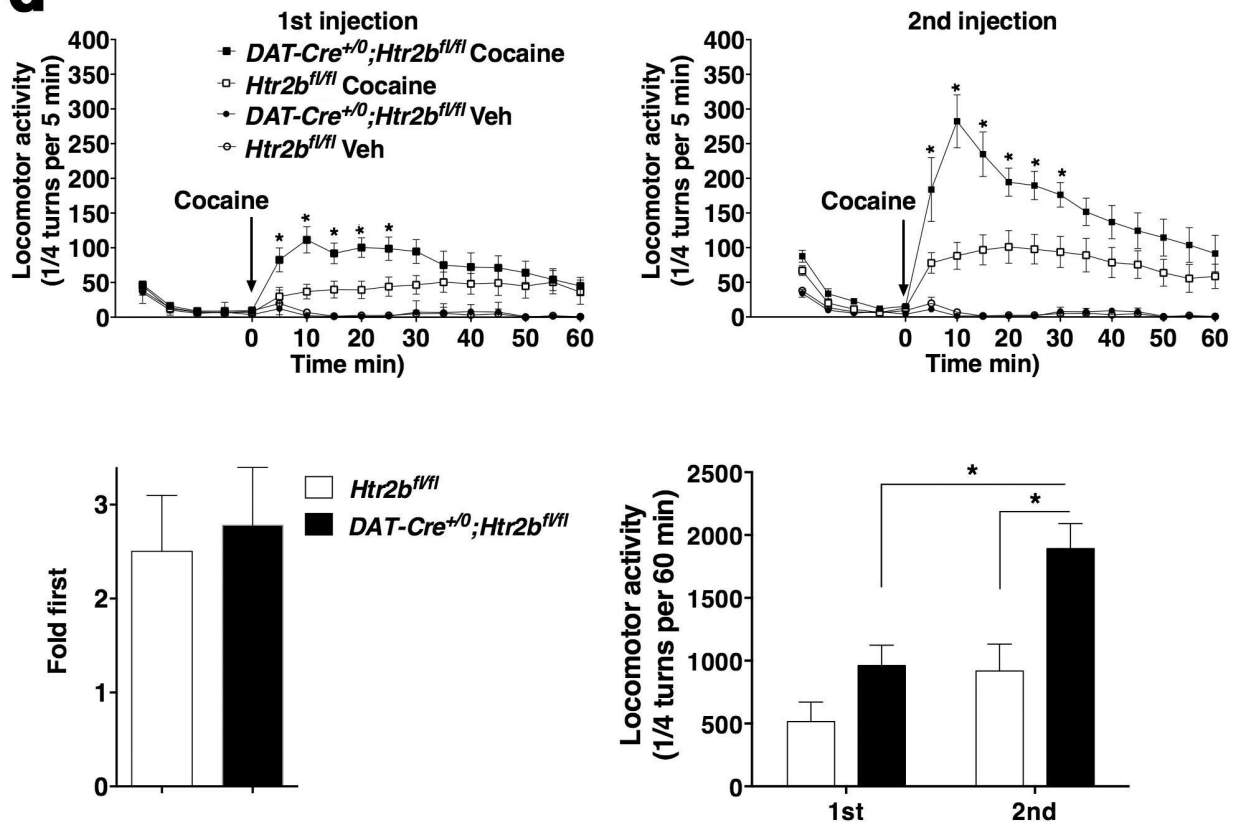

Fig. 6. Conditional deletion of 5-HT_{2B} receptors in DA neurons, *Htr2b*^{DAKO} mutant mice. a-c : **Mapping and genotyping of *Htr2b*^{DAKO} mutant mice.** Top: 5-HT_{2B} receptor locus indicating the positions of exons, (Exon 1, Ex1; Exon 2, Ex2) and restriction sites used for the targeting construct. Middle: targeting vector designed to floxed exon 2 by homologous recombination in genomic DNA generating the targeted locus (below). Exons 1– 2 are depicted by white (untranslated) and black boxes (coding) and Neomycin resistance by grey box (NEO). Bottom: sequenced-verified structure of the *Htr2b* null allele (KO) after excision by Cre recombinase of the sequence flanked by LoxP sites (triangles). Horizontal arrows illustrate the position of primers used for genotyping (F1, R1, R2). **b :** Genomic DNA of VTA from *Htr2b*^{DAKO} mice was extracted and analyzed by PCR, revealing the effective proper recombination (F1, R2 amplimers, 309 bp). **c :** Efficient Cre recombination in TH positive neurons. Immunofluorescence revealed the recombinase-dependent GFP expression in VTA, which colocalized with the TH antibody staining as seen by confocal microscopy in coronal section of VTA of *Dat-Cre*^{+/⁰;RCE (*Dat-GFP*) mice (inset); scale bars: 250 μ m, inset 50 μ m. **d :** **Restricted 5-HT_{2B} receptor inactivation to DA neurons leads to increased locomotor response to cocaine.** An injection of cocaine (20 mg/kg) increased significantly more locomotor activity in *Htr2b*^{DAKO} (*Dat-Cre*^{+/⁰;Htr2b^{fl/fl} cocaine, black square, n = 10) than in Cre negative littermate mice (*Htr2b*^{fl/fl} cocaine, white square, n = 10; 1st injection, left, arrow cocaine injection t = 0), as analyzed using two-way ANOVA RM, while no locomotor difference was found following vehicle in *Htr2b*^{DAKO} (Veh-black circle, n = 10) or in *Htr2b*^{fl/fl} (Veh-white circle, n = 10). The stimulant locomotor effect of a challenge dose of cocaine seven days later (2nd injection, right, arrow cocaine injection t = 0) was also significantly higher in *Htr2b*^{DAKO} compared to *Htr2b*^{fl/fl} mice, while no locomotor difference was found following vehicle in *Htr2b*^{DAKO} (Veh-black circle, n = 10) or in *Htr2b*^{fl/fl} (white circle, n = 10). The increase in cocaine induced-locomotor activity at the second injection was similar in respect to the first (Fold first) (n=10-10; unpaired t-test). Total locomotor activity recorded over 60 min after a 2nd injection was significantly higher in *Htr2b*^{DAKO} compared to *Htr2b*^{fl/fl} littermate mice and compared to the 1st injection, as analyzed using two-way ANOVA RM for cocaine (n = 10-10) (means \pm SEM). Bonferroni post-hoc tests were applied to each graph, *P<0.05.}}

Figure 7

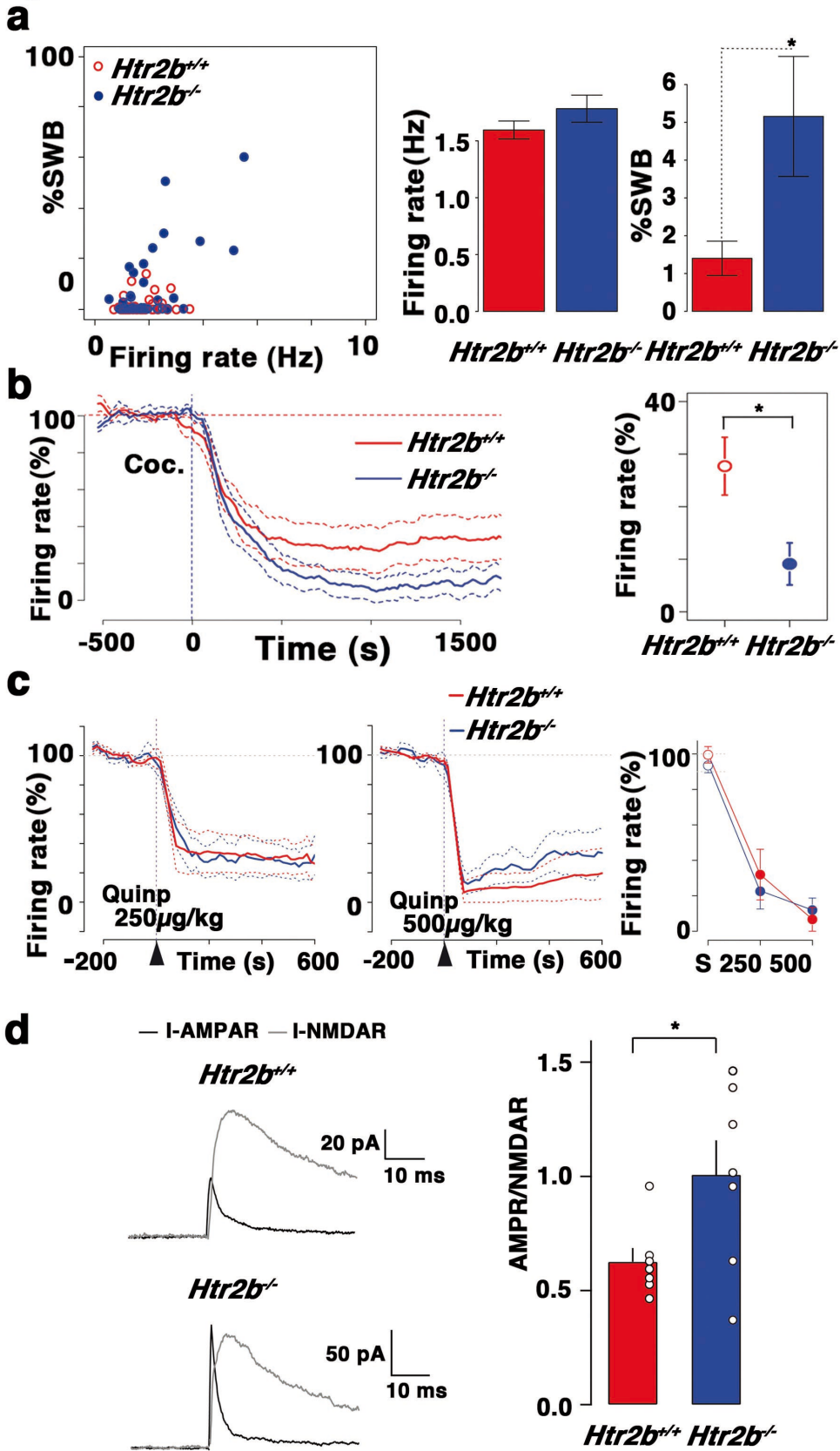

Fig. 7. Electrophysiological effects of 5-HT_{2B} receptor knockout on VTA DA neurons. a : **Changes in basal *in-vivo* firing of *Htr2b*^{-/-} VTA DA neurons.** After *in-vivo* recordings, the mean frequency (Hz) was plotted against the percentage of spikes within a burst (%SWB) of DA neurons in *Htr2b*^{+/+} (red, n = 57) and *Htr2b*^{-/-} mice (blue, n = 58). Barplot shows no change in the mean frequency (left) and a significant increase in percentage of SWB (right) for the same groups (unpaired t-test-Welch corrected). **b :** **Cocaine induced a stronger decrease in firing rate of VTA DA neurons in *Htr2b*^{-/-} mice.** Systemic ip injection of cocaine (20 mg/kg) in *Htr2b*^{+/+} (10 mice; red line) and *Htr2b*^{-/-} (9 mice; blue line) mice produced a decrease of firing rate. On average, cocaine-induced decrease in firing rate was significantly stronger in *Htr2b*^{-/-} than in *Htr2b*^{+/+} mice (unpaired t-test-Welch corrected). The percentage of variation in firing rate (right) is illustrated. **c :** **No change in quinpirole-dependent decrease in firing rate of VTA DA neurons in *Htr2b*^{-/-} mice.** Systemic ip injection of the D2 agonist quinpirole (Quinp 250-500 µg/kg) in *Htr2b*^{+/+} (n = 6-5 mice; red line) and *Htr2b*^{-/-} (n = 7-6 mice; blue line) mice produced similar decrease of firing rate. The percentage of variation in firing rate (right) is illustrated for the two concentrations. **d :** **Strengthening of AMPA transmission in the VTA neurons of *Htr2b*^{-/-} mice.** Representative sample traces for AMPAR- (black) and NMDAR-EPSCs (gray) recorded at +40 mV in DA neurons from the lateral part of the VTA that are prone to project to the NAcc shell of *Htr2b*^{-/-} and *Htr2b*^{+/+} mice. (right): Bar graph and scatter plot illustrate the significant increase in AMPA/NMDA ratio in the *Htr2b*^{-/-} vs. *Htr2b*^{+/+} mice (unpaired t-test, n = 7-7).

Figure 8

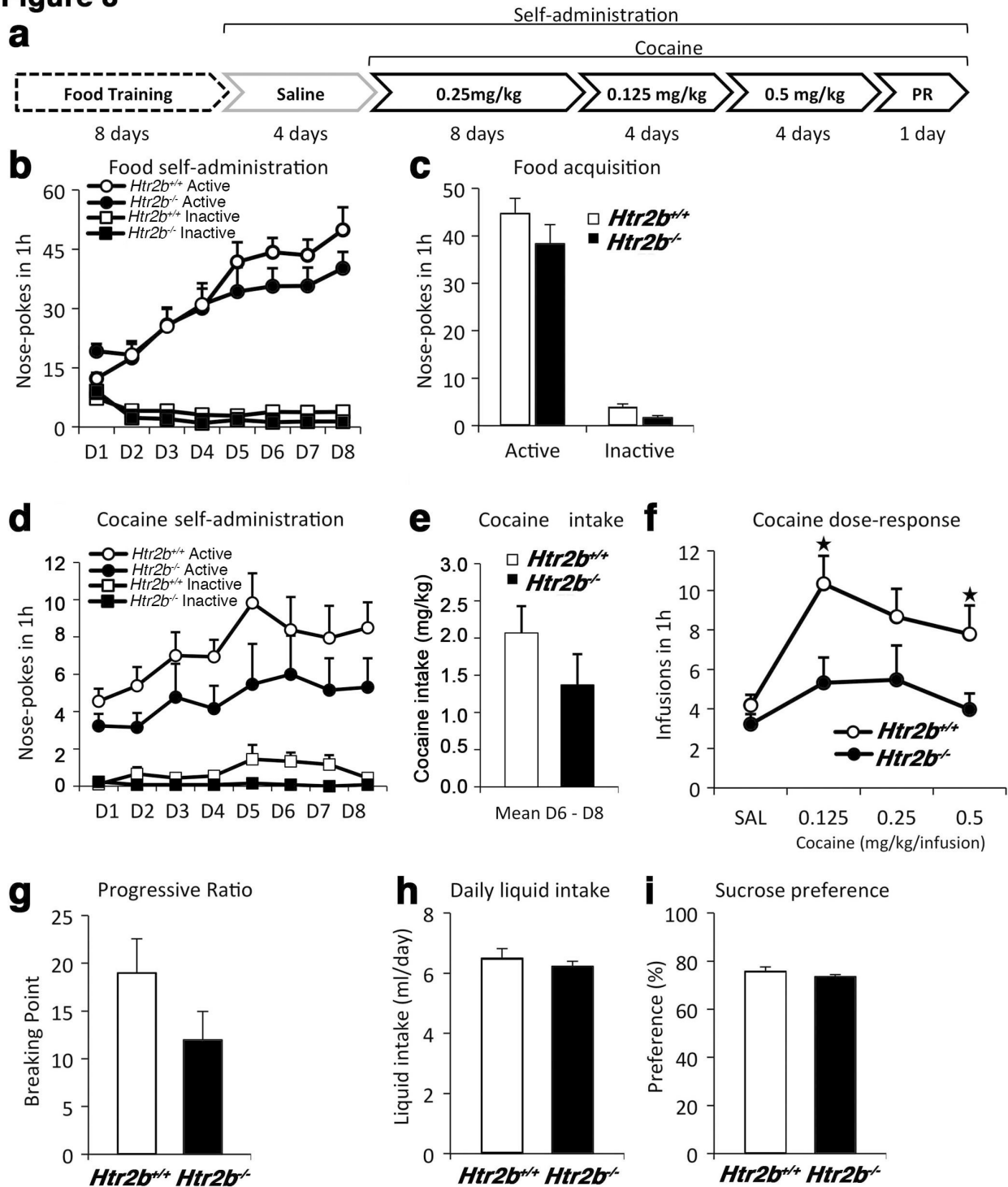

Fig 8. Cocaine self-administration in *Htr2b*^{-/-} mice.

a : Timeline for the self-administration experiments. b-c : Similar training to food pellets in *Htr2b*^{+/+} and *Htr2b*^{-/-} mice. Mice were first trained to respond for food pellets under FR1 schedule of reinforcement in one-hour daily self-administration sessions until responding for food criteria was acquired. A significant increase in nose-poke responding was observed during the first sessions leading to a learning-curve pattern in both groups of mice. Data analyzed by three-way ANOVA showed an effect of the day. The discrimination between active and inactive nose-poke responding was rapidly acquired in both, *Htr2b*^{+/+} and *Htr2b*^{-/-} mice (**b**). No statistical differences between genotypes were obtained when data from the acquisition days was analyzed (**c**). **d-g : Lower cocaine self-administration in *Htr2b*^{-/-} mice.** A saline solution was presented first until a low and stable responding pattern was obtained. Mice were then trained to self-administer cocaine at the dose of 0.25 mg/kg/infusion during 8 days on a FR1 schedule of reinforcement (**d**). *Htr2b*^{-/-} mice show a non-significant decrease in the mean intake of cocaine (mg/kg) during the last 3 days of training (**e**). In the dose-response curve for cocaine self-administration, *Htr2b*^{-/-} mice earned a significantly lower number of cocaine infusions at the doses of 0.125 and 0.50 mg/kg/infusion ($p < 0.05$) (**f**). Each point represents the mean of 4 days of responding for each dose. For saline and for the dose of 0.25 mg/kg/infusion, the point shown represents the mean of the last 4 days of training. Subsequently, a progressive ratio procedure was performed in order to test the motivation of mice to work for cocaine at the dose of 0.125 mg/kg/infusion (**g**). The trend toward a lower break point in the progressive ratio schedule of reinforcement test did not reach significance (unpaired t-test). **h-i : No difference in post-cocaine reward system between genotypes.** To evaluate the effects of 5-HT_{2B}-receptor deletion on post-cocaine reward system, two bottles of water were first available to individually caged mice and liquid consumption was monitored during two consecutive days (**h**). Then, the liquid from one of the bottles was replaced with a 2% sucrose solution and liquid intake measurements was performed daily during 3 days (**i**). Total liquid intake, as well as, sucrose preference was evaluated in *Htr2b*^{+/+} and *Htr2b*^{-/-} mice. No statistical differences between genotypes were obtained. (n = 18-13, unpaired t-test).