



HAL
open science

An improvement of Hardy Cross method applied on looped spatial natural gas distribution networks

Dejan Brkic

► **To cite this version:**

Dejan Brkic. An improvement of Hardy Cross method applied on looped spatial natural gas distribution networks. *Applied Energy*, 2009, 86 (7-8), pp.1290-1300. 10.1016/j.apenergy.2008.10.005 . hal-01586553

HAL Id: hal-01586553

<https://hal.science/hal-01586553v1>

Submitted on 13 Sep 2017

HAL is a multi-disciplinary open access archive for the deposit and dissemination of scientific research documents, whether they are published or not. The documents may come from teaching and research institutions in France or abroad, or from public or private research centers.

L'archive ouverte pluridisciplinaire **HAL**, est destinée au dépôt et à la diffusion de documents scientifiques de niveau recherche, publiés ou non, émanant des établissements d'enseignement et de recherche français ou étrangers, des laboratoires publics ou privés.

Elsevier Editorial System(tm) for Applied Energy
Manuscript Draft

Manuscript Number: APEN-D-08-00425R2

Title: An Improvement of Hardy Cross Method Applied on Looped Spatial Natural Gas Distribution Networks

Article Type: Original Paper

Keywords: Hardy Cross method; Natural gas; Flow; Pipeline network

Corresponding Author: Mr Dejan Brkić, M.Sc in petroleum eng. PhD student

Corresponding Author's Institution: Ministry of Science and Technological Development

First Author: Dejan Brkić, M.Sc in petroleum eng. PhD student

Order of Authors: Dejan Brkić, M.Sc in petroleum eng. PhD student

Abstract: Hardy Cross method is common for calculation of loops-like gas distribution networks with known node gas consumptions. This method is given in two forms: original Hardy Cross method-successive substitution methods and improved-simultaneous solution method (Newton-Raphson group of methods). Problem of gas flow in looped network is nonlinear problem; i.e. relation between flow and pressure drop is not linear while relation between electric current and voltage is. Improvement of original method is done by introduction of influence of adjacent contours in Yacobian matrix which is used in calculation and which is in original method strictly diagonal with all zeros in non-diagonal terms. In that way necessary number of iteration in calculations is decreased. If during the design of gas network with loops is anticipated that some of conduits are crossing each other without connection, this sort of network became, so there has to be introduced corrections of third or higher order.

Reviewer #1: All corrections are done according my suggestions. I have only two marginal notes:

1. Avoid (2a), (2b) for equations mark. Put only numbers in brackets and renumber all equation according this suggestion. This is more comfortable for readers.

Answer:

Suggestion accepted in full. All equations in the text are renumbered.

2. Note your eq (10) and (16) are identical. This relation is essential and mutual for both methods, but then please, delete eq 16 and in text refer to eq 10.

Suggestion accepted in full. This is now only eq. 7. in new version.

This is very complex paper, with good literature support. Tables are very useful and all calculation can be repeated by the readers. This manuscript can be accepted without further reviews.

Reviewer #2: This paper is a revision of a previous submission. The author has done a good job of revising the paper to address the deficiencies noted in the original submission. The paper reads much better now. However, there are still grammatical/editorial errors in the manuscript. These will need to be corrected by the editorial staff prior to publication. The Figures have been upgraded to clear up confusion in the previous version. The previous Figure 10 has been modified as Figure 7 in the revised paper. But the reliance on colour to make the Figure's point will still create a problem since the paper will be published in black and white print.

Answer: English expression is now probably improved and the text is shorter for about 1000 words, one table is deleted, and one figure is deleted. Shorter abstract is included. Readers will have access to online base e.g. science direct, so there will be available version in colour.

Editor:

1. The length of the manuscript is over the required 10 printing pages by Applied

Energy. Authors shall shorten to make it much concise.

Suggestion accepted in full: Text is shorter for about 1000 words, one table is deleted, and one figure is deleted. Many equations are deleted, only necessary equations are now in the text. References are checked, and only essential references are still in the text. In the text is something above 5000 words including title, abstract, references...

2. Authors shall discuss how to apply the results in real applications to give

readers who might be interesting to use the results from this paper.

Suggestion accepted in full: This matter are now discussed in the conclusion. Conclusion is now much more concise.

An Improvement of Hardy Cross Method Applied on Looped Spatial Natural Gas Distribution Networks

Dejan Brkić

Ministry of Science and Technological Development, Đušina 7, 11000 Beograd, Serbia

Abstract:

Hardy Cross method is common for calculation of loops-like gas distribution networks with known node gas consumptions. This method is given in two forms: original Hardy Cross method-successive substitution methods and improved-simultaneous solution method (Newton-Raphson group of methods). Problem of gas flow in looped network is nonlinear problem; i.e. relation between flow and pressure drop is not linear while relation between electric current and voltage is. Improvement of original method is done by introduction of influence of adjacent contours in Yacobian matrix which is used in calculation and which is in original method strictly diagonal with all zeros in non-diagonal terms. In that way necessary number of iteration in calculations is decreased. If during the design of gas network with loops is anticipated that some of conduits are crossing each other without connection, this sort of network became, so there has to be introduced corrections of third or higher order.

Keywords: Hardy Cross method, Natural gas, Flow, Pipeline network

Nomenclature

Q_a -gas flow reduced to absolute pressure (m^3/s),

Q -gas flow reduced to standard value of pressure and temperature (m^3/s)

v -gas flow velocity (m/s),

A_c -surface value of cross section (m^2),

D_{in} -inner diameter of conduit (m),

π -Ludolph's number (=3.14159),

p_2 - pressure at conduit exit (Pa),

p_1 -pressure at conduit entrance (Pa),

ρ_r -relative gas density (-),

L -conduit length (m),

R -hydraulic resistance, flow resistance (m/m^n) (in electric networks equivalent Ω)

n -flow equation exponent ($n=1,82$ in Renouard equation),

m -mark observed iteration,

X -number of conduits (pipes, main, manifolds)

Y -number of nodes

i, j, k -counter

Δ -flow correction (m^3/s)

A, K, G, D -Bull's variables (1 or 0)

$\bar{A}, \bar{K}, \bar{G}, \bar{D}$ -mark complementary value of Bull's variable (if Bull's variable u has value 1, then its complementary value \bar{u} is 0, and opposite)

C -auxiliary Bull's variable (1 or 0)

1. Introduction

For single source, branching networks, only the reach equations need to be solved (e.g. using Hazen-Williams for water or Renouard for natural gas). In this case, optimization by linear programming could yield the best alternative network, both hydraulically and economically [1].

Critical path analysis for optimizing branched pipe networks and implementation of the finite

element method can be done for branched networks. For looped networks, however, techniques that are more powerful are required. Algorithms have been developed to ensure convergence of the iterative procedures.

Today, Hardy Cross method [2] is very often used for optimization of gas distribution networks with loops of conduits. Hardy Cross¹ developed a numerical method for calculating flow and pressure distribution in a looped network. This method also has been widely used in modeling of waterworks with ring-like structures of conduits in municipalities. Hardy Cross method assumes an equilibrium between pressure and friction forces in steady and incompressible flow. As a result, it cannot be successfully used in unsteady and compressible flow calculations with large pressure drop where inertia force is important. Original and improved Hardy Cross method, are methods of successive iterative corrections, but for the first one, corrections are calculated for each contour separately, while for the second one, corrections for all contours in each iteration is calculated simultaneously using the Newton-Raphson numerical procedure. Hardy Cross method is one approach to solve the loop equations. Original method first determines corrections for each loop independently and applies this correction to compute new flow in each conduit. It is not efficient compared to improved Hardy Cross method that considers entire system simultaneously. Simultaneous method is used by Epp and Fowler [3], but only for looped waterworks systems.

¹ Hardy Cross (Nansemond County, Virginia 1885 - Virginia Beach, Virginia 1959), American engineer, assistant professor of civil engineering at Brown University, professor of structural engineering at the University of Illinois, Chair of the Department of Civil Engineering at Yale. He had also developed a method for analysing indeterminate structures that minimized the inconveniences and risks involved in the use and development of reinforced concrete.

Some methods developed by Russian authors are similar with original Hardy Cross method. Contemporary with Hardy Cross, soviet author V.G. Lobachev [4] was being developed very similar method compared to original Hardy Cross method. Andrijashev method [5] was very often being used in Russia during the soviet era. According to this method, contour and loop are not synonyms (contours for calculations has to be chosen to include few loops and only by exception one).

Using the loop equations to represent conservation of energy, Wood and Charles [6] developed a linear theory (flow adjustment) method by coupling the loop equations with node equations. Convergence characteristics of linear theory are later improved by Wood and Rayes [7]. Modified linear theory solves directly for the conduits flow rates rather than the loop equations approach of Hardy Cross method. Shamir and Howard [8] solved node equations instead loop equations using the Newton-Raphson method. After the nodal heads are computed, they computed the conduits flow rates. Previous methods solve for the conduits flows or nodal heads separately then use conservation of energy to determine the other set of unknowns. Haman and Brameller [9], and, Todini and Pilati [10] devised a method to solve for flows and heads simultaneously. Here, each conduit equation is written to include, both, the conduit flows and nodal heads. In addition, although the number of equations is larger than the other methods, the algorithm does not require defining loops. Further procedure is developed by Patankar [11]. He developed a finite volume procedure to solve for Navier-Stokes equations in a structured coordinate system. Since the publication of the original paper in 1972, there have been several developments reported to improve the numerical performance of the original algorithm. Datta

and Majumdar [12] used this solution algorithm to develop a calculation procedure for manifold flow systems.

Examples of calculation of looped natural gas distribution network after original Hardy Cross method can be found in handbooks [13] and similar calculation of real gas network is shown in paper of Manojlović et al. [14]. But, deeper improvement of Hardy Cross method is only shown in case of looped waterworks systems [15]. Analysis of looped gas distribution networks is shown in paper of Osiadacz [16] while in many papers are shown methods for calculation of waterworks [17-29]. Very interesting application of two ant colony optimisation algorithms to water distribution system optimisation is shown in the paper of Zecchin et al. [30].

2. Concept of distribution network

Hardy Cross method is powerful tool for calculation of looped gas distribution network in settlements without limitation factors, such as: number of conduits per contours, number of loops, number of nodes or number of input nodes. In Hardy Cross calculation, previously, has to be determined maximal consumption per each node (Q_{output}), and one or more inlet nodes (Table 1). These parameters are looked up. Now, initial guess of flow per conduits has to be assigned (Table 2), and in that way chosen values are to be used for first iteration. After the iteration procedure is completed, and if the value of gas flow velocity for all conduits are below standard values, calculated flows² become flow distribution per conduits for maximal possible consumptions per nodes. Further, pressure per all nodes can be calculated. Whole network can be supplied by gas from one or more points (nodes). Distribution network must be design for largest consumption assigned to nodes of networks chosen to satisfy largest possible gas consumption of

² see Table 5

households in condition of very severe winters (Table 1)³. Disposal of households is along the network's conduits, and only their consumption is to be assigned to nodes for the purpose of calculation according to Hardy Cross. Task of Hardy Cross method is to calculate gas flow distribution per conduits for fixed looked up maximal natural gas consumption per nodes and inputs in network. If the flow speed in some conduits are above standard values after the calculation is finished, these conduits must be chosen with larger diameters, and whole iteration procedure have to be repeated⁴. Hardy Cross method is only suitable for calculation of looped networks, not for branch-like networks. Before start of iterative procedure, consumption of gas per node, input nodes, their spatial disposal and length of conduits must be chosen and looked up. Then, first guess of flow for all conduits must be chosen according to first Kirchhoff's law for each of the node nodes. Next, diameters of all conduits have to be chosen (after eq. (1); see I in Table 2, or not; see II in Table 2).

$$Q_a = v \cdot A_c = v \cdot \frac{D_{in}^2 \cdot \pi}{4} \Rightarrow D_{in} = \sqrt{\frac{4 \cdot Q_a}{v \cdot \pi}} \quad (1)$$

In previous equation (1), flow is reduced to absolute value of pressure, and if flow is given for standard value is to be reduced using $p_a \cdot Q_a = p_n \cdot Q_n$. In distribution network pressure value is usually $p_a = 4 \cdot 10^5$ Pa abs., or $3 \cdot 10^5$ Pa gauge pressure. First larger standard diameter than calculated after eq. (1) has to be chosen (du~Du) from the tables of standard polyethylene pipes.

³ for example networks shown in Fig. 2

⁴ see conduit 3' in Table 5.

Each equation for determination of pressure drop in distribution gas network [31] (e.g. in the technical literature the Renouard equation for conditions of pressure values in gas distribution networks comes written in an explicit form in terms of the pressure difference) (2)⁵:

$$p_2^2 - p_1^2 = 4810 \cdot \frac{\rho_r \cdot L \cdot Q^{1.82}}{D_{in}^{4.82}} \quad (2)$$

can be written in form $\Delta p^2 = R \cdot Q^n$, where is: $n=1.82$, and hydraulics resistance R is to be written as $R=4810 \cdot \rho_r \cdot L \cdot D_{in}^{-4.82}$.

Basics assumption is to be satisfied for Hardy Cross calculation:

- Algebraic sum of flows per each node must be zero exactly (first Kirchhoff's law- continuity of flow),
- Algebraic sum of pressure drops per each contour must be approximately zero at the end of iterative procedure (second Kirchhoff's law - continuity of potential).

It is usually desired to determine the total loss of pressure or voltage between inlet and outlet. If a single conductor connected these two points, the loss of head for given flow could be computed directly from the relation between flow and head loss. In a network, however, this loss depends on the distribution of the flow in the system. If such distribution is known, the drop of potential in each conductor can be determined directly, and the total drop found as the sum of the drops along any path connecting inlet and outlet, the total drop being of course the same whatever path is chosen. If, however, the relation is not linear as for gas flow (2), serious difficulties arise in solving the equations. This problem must be solved during iterative procedure.

⁵ whereas in the technical literature it appears as: $\Delta p^2 = 4088 \cdot \rho_r^{0.82} \cdot L \cdot Q^{1.82} \cdot D_{in}^{-4.82}$

In general, systems for distributing natural gas in cities may, for purposes of analysis, be considered as in a single plane. In other cases, as, for example, the distribution may take place in several planes, with interconnection between the planar systems of distribution (Fig. 1). This type of problem presents no especially new features except that distribution must be made in circuits closed by the risers as well as in the circuits which lie in a plane. It will be noted that in such problems any conduit may lie in only one circuit (an outside conduit in a floor) or in two circuits, three circuits, or even in four circuits (two floor circuits and two riser circuits). The total change in flow in the conduit is the sum of the changes in all the circuits of which it is a member. All networks with three or more dimensions can be noted as spatial. Spatial network is each network with at least one conduit mutual for three or more contours. In fig. 1, networks A) can be reduced to single plane problem, but case C) is three-dimensional problem as in our example in fig 2⁶.

3. Mathematical description of network

The first step in solving a problem is to make a network map showing conduit sizes and lengths, connections between conduits (nodes), and sources of supply. For convenience in locating conduits, assign each contour and each main a code number. Conduits on the network periphery are common to one contour and those in the network interior are common to two contours.

Special cases may occur in which two conduits cross each other but are not connected, resulting in certain conduits being common to three or more loops. The distribution network then becomes three-dimensional rather than two-dimensional.

⁶ and in Fig 7

Figure 2⁷ is an example of a three-dimensional network because conduit 15 is not connected to conduit 6. Conduits 1 to 14 form a two-dimensional network of four contours. Contour 5 consists of conduits 15, 9, 10, 11, and 12. Conduits 9, 10, and 11 are each common to two contours (5 and 3, 5 and 3, and 5 and 2, respectively) and conduit 12 is common to three contours (2, 4, and 5). Contour 5 could have been chosen along several other paths in the two-dimensional network; for example, by starting at the right end of conduit 15 via conduit 8 and returning to the left end of conduit 15 via conduit 2 or 3.

Gas distribution system, composed of fifteen conduits (Fig. 2), has been analyzed by the Hardy Cross method (original and improved version) to determine the individual conduit flow rates and pressure drops. Gas flow into the network from a source on the left side is 7000 m³/h (Table 1.). Points of delivery are at junctions of conduits, with the arrows pointing to volumes delivered (summation of these deliveries equals 7000 m³/h). Assumed gas flow and its direction, also indicated by an arrow (near pipe in fig. 2).

After the network map with its conduit and contour numbers and delivery and supply data has been prepared, the next step is to assume a flow pattern in the network (Table 2). This may be done by starting at sources with volumes of gas delivered into the system, and distributing these volumes through the conduits until they have been allocated to the various delivery points. The flows thus assumed are entered next to their respective conduits, with arrows to indicate direction. The total gas flow arriving at a junction must equal the total gas flow leaving it (first Kirchhoff's law). The assumed flow pattern will approximate the correct flow pattern if consideration is given to the relative flow capacity of various network conduits.

⁷ and Fig 7

To introduce matrix form in calculation, it is necessary to represent distribution network (Fig. 2) as a graph according to Euler's theorem from mineralogy (number of polyhedral angles and edges of minerals). Graph has X branches and Y nodes (in Fig. 2: X=15, Y=11). Graph with n nodes has Y-1 independent nodes and X-Y+1 independent loops. Tree is a set of connected branches chosen to connect all nodes, but not to closed any closed path (not to form loop) – in fig. 2 e.g. conduits 13, 11, 10, 9, 15, 3, 4, 1, 5, 7 or other combination. Branches, which do not belong to a tree, are links (number of links are X-Y+1). Number of independent loops in network are formed using tree conduits and one of the links conduit). So, number of loops are determined by number of links. In graph, one node is referent (in Fig. 2 referent node is I) and all others are so called dependent nodes. In example from fig. 2 for 1st guess referent node is I (3). So first row in matrix is for node 2, second for node 3, etc., and last row is for node Y-1 (i.e. XI).

$$\begin{bmatrix}
 -1 & 0 & 0 & 1 & 0 & 0 & 0 & 0 & 0 & 0 & 0 & 0 & 0 & 0 & 0 \\
 1 & 1 & 0 & 0 & -1 & 0 & 0 & 0 & 0 & 0 & 0 & 0 & 0 & 0 & 0 \\
 0 & -1 & 1 & 0 & 0 & 0 & 0 & 0 & 0 & 0 & 0 & -1 & 0 & 0 & -1 \\
 0 & 0 & 0 & 0 & 0 & 0 & 0 & 0 & 0 & 0 & -1 & 1 & 1 & 0 & 0 \\
 0 & 0 & 0 & 0 & 0 & 0 & 0 & 0 & 0 & 0 & 0 & 0 & -1 & 1 & 0 \\
 0 & 0 & 0 & 0 & 1 & 1 & -1 & 0 & 0 & 0 & 0 & 0 & 0 & 0 & 0 \\
 0 & 0 & 0 & 0 & 0 & 0 & 1 & 1 & 0 & 0 & 0 & 0 & 0 & 0 & 0 \\
 0 & 0 & 0 & 0 & 0 & 0 & 0 & -1 & -1 & 0 & 0 & 0 & 0 & 0 & 1 \\
 0 & 0 & 0 & 0 & 0 & 0 & 0 & 0 & 1 & -1 & 0 & 0 & 0 & 0 & 0 \\
 0 & 0 & 0 & 0 & 0 & -1 & 0 & 0 & 0 & 1 & 1 & 0 & 0 & 0 & 0
 \end{bmatrix}
 \begin{matrix}
 Q_1 \\
 Q_2 \\
 Q_3 \\
 Q_4 \\
 Q_5 \\
 Q_6 \\
 Q_7 \\
 Q_8 \\
 Q_9 \\
 Q_{10} \\
 Q_{11} \\
 Q_{12} \\
 Q_{13} \\
 Q_{14} \\
 Q_{15}
 \end{matrix}
 *
 \begin{matrix}
 Q_{II-output} \\
 Q_{III-output} \\
 Q_{IV-output} \\
 Q_{V-output} \\
 Q_{VI-output} \\
 Q_{VII-output} \\
 Q_{VIII-output} \\
 Q_{IX-output} \\
 Q_{X-output} \\
 Q_{XI-output}
 \end{matrix}
 =
 \begin{matrix}
 Q_{II-output} \\
 Q_{III-output} \\
 Q_{IV-output} \\
 Q_{V-output} \\
 Q_{VI-output} \\
 Q_{VII-output} \\
 Q_{VIII-output} \\
 Q_{IX-output} \\
 Q_{X-output} \\
 Q_{XI-output}
 \end{matrix}
 \quad (3)$$

In (3); 1 means that particular conduit has input in observed node, -1 if not and 0 if this particular conduit do not belong to observed node. If network has two or more points of supply, that can be included in eqs. (3) as Q_i but with negative sign.

Equation (3) can be written as (4) in develop form:

$$\left. \begin{aligned}
 -Q_1 + Q_4 - Q_{II-output} &= 0 \\
 Q_1 + Q_2 - Q_5 - Q_{III-output} &= 0 \\
 -Q_2 + Q_3 - Q_{12} - Q_{15} - Q_{IV-output} &= 0 \\
 -Q_{11} + Q_{12} + Q_{13} - Q_{V-output} &= 0 \\
 -Q_{13} + Q_{14} - Q_{VI-output} &= 0 \\
 Q_5 + Q_6 - Q_7 - Q_{VII-output} &= 0 \\
 Q_7 + Q_8 - Q_{VIII-output} &= 0 \\
 -Q_8 - Q_9 + Q_{15} - Q_{IX-output} &= 0 \\
 Q_9 - Q_{10} - Q_{X-output} &= 0 \\
 -Q_6 + Q_{10} + Q_{11} - Q_{XI-output} &= 0
 \end{aligned} \right\} \text{nodes} \quad (4)$$

For independent loops can be written set of $X-Y+1$ independent equations of energy continuity for network shown in fig. 2. can be written as (5):

$$\begin{bmatrix}
 1 & -1 & -1 & 1 & 0 & 0 & 0 & 0 & 0 & 0 & 0 & 0 & 0 & 0 \\
 0 & 1 & 0 & 0 & 1 & -1 & 0 & 0 & 0 & 0 & -1 & -1 & 0 & 0 \\
 0 & 0 & 0 & 0 & 0 & 1 & 1 & -1 & 1 & 1 & 0 & 0 & 0 & 0 \\
 0 & 0 & 1 & 0 & 0 & 0 & 0 & 0 & 0 & 0 & 0 & 1 & -1 & -1 \\
 0 & 0 & 0 & 0 & 0 & 0 & 0 & 0 & 1 & 1 & -1 & -1 & 0 & 1
 \end{bmatrix} * \begin{bmatrix} \Delta p_1^2 \\ \Delta p_2^2 \\ \Delta p_3^2 \\ \vdots \\ \Delta p_{15}^2 \end{bmatrix} = 0 \quad (5)$$

In (5); 1 means that flow direction in conduit coincides with assumed direction of observed contour, -1 if not, and 0 if conduit do not belong to observed contour.

Equation (3) can be written as (4) in develop form:

$$\begin{aligned}
& \Delta p_1^2 - \Delta p_2^2 - \Delta p_3^2 + \Delta p_4^2 = \\
& = 4810 \cdot \rho_r \left(\frac{L_1 \cdot Q_1^{1,82}}{D_1^{4,82}} - \frac{L_2 \cdot Q_2^{1,82}}{D_2^{4,82}} - \frac{L_3 \cdot Q_3^{1,82}}{D_3^{4,82}} + \frac{L_4 \cdot Q_4^{1,82}}{D_4^{4,82}} \right) = 0 \\
& \Delta p_2^2 + \Delta p_5^2 - \Delta p_6^2 - \Delta p_{11}^2 + \Delta p_{12}^2 = \\
& = 4810 \cdot \rho_r \left(\frac{L_2 \cdot Q_2^{1,82}}{D_2^{4,82}} + \frac{L_5 \cdot Q_5^{1,82}}{D_5^{4,82}} - \frac{L_6 \cdot Q_6^{1,82}}{D_6^{4,82}} - \frac{L_{11} \cdot Q_{11}^{1,82}}{D_{11}^{4,82}} + \frac{L_{12} \cdot Q_{12}^{1,82}}{D_{12}^{4,82}} \right) = 0 \\
& \Delta p_6^2 + \Delta p_7^2 - \Delta p_8^2 + \Delta p_9^2 + \Delta p_{10}^2 = \\
& = 4810 \cdot \rho_r \left(\frac{L_6 \cdot Q_6^{1,82}}{D_6^{4,82}} - \frac{L_7 \cdot Q_7^{1,82}}{D_7^{4,82}} - \frac{L_8 \cdot Q_8^{1,82}}{D_8^{4,82}} + \frac{L_9 \cdot Q_9^{1,82}}{D_9^{4,82}} + \frac{L_{10} \cdot Q_{10}^{1,82}}{D_{10}^{4,82}} \right) = 0 \\
& \Delta p_3^2 + \Delta p_{12}^2 - \Delta p_{13}^2 - \Delta p_{14}^2 = \\
& = 4810 \cdot \rho_r \left(\frac{L_3 \cdot Q_3^{1,82}}{D_3^{4,82}} + \frac{L_{12} \cdot Q_{12}^{1,82}}{D_{12}^{4,82}} - \frac{L_{13} \cdot Q_{13}^{1,82}}{D_{13}^{4,82}} - \frac{L_{14} \cdot Q_{14}^{1,82}}{D_{14}^{4,82}} \right) = 0 \\
& \Delta p_9^2 + \Delta p_{10}^2 - \Delta p_{11}^2 - \Delta p_{12}^2 + \Delta p_{15}^2 = \\
& = 4810 \cdot \rho_r \left(\frac{L_9 \cdot Q_9^{1,82}}{D_9^{4,82}} + \frac{L_{10} \cdot Q_{10}^{1,82}}{D_{10}^{4,82}} - \frac{L_{11} \cdot Q_{11}^{1,82}}{D_{11}^{4,82}} - \frac{L_{12} \cdot Q_{12}^{1,82}}{D_{12}^{4,82}} + \frac{L_{15} \cdot Q_{15}^{1,82}}{D_{15}^{4,82}} \right) = 0
\end{aligned} \tag{6}$$

$\left. \begin{array}{l} F_1 \\ F_2 \\ F_3 \\ F_4 \\ F_5 \end{array} \right\} \text{contours}$

Equations (3-6) are for initial guess of gas flow rate I from Table 2 and Fig 2.

4. General solution after Hardy Cross method

Two types of methods based on Hardy Cross's idea are shown for the solution of loop equations:

- Hardy Cross method; successive substitution method (single loop adjustment method)
- Modified Hardy Cross method; simultaneous loop solution method (Newton-Raphson method)

4.1 Hardy Cross's successive substitution method (single loop adjustment method)

Equations of flow (for conduits i which belong to contour j) for all contours (each particular contour is marked by j) can be written as follows (7):

$$F(Q)_j = \left\{ \sum (R_i \cdot Q_i^n) \right\}_j \tag{7}$$

The basic idea of the Hardy-Cross method is that conservation of mass at each node can be established initially. This means we must first assume an initial guess of flows in every pipe

element before starting the pressure drop calculation. For any pipe in which Q_0 is assumed to be the initial flow rate, eq. (7) can be estimated using a Taylor series expansion as follows (8):

$$F(Q_i)_j^{(m)} \approx F(Q_i)_j^{(m-1)} + \left\{ \sum (Q_i^{(m)} - Q_i^{(m-1)}) \right\}_j \cdot \frac{\partial F(Q_i)_j}{1! \cdot \partial(\Delta Q_j)} \quad (8)$$

Because of second Kirchof's law in late iterations; $F(Q)^{(m)} \rightarrow 0$, and $\Delta_j = \Delta Q_j = (Q_i^m - Q_i^{m-1})_j$

$$F(Q)^{(m-1)} + \Delta_j \cdot \sum \frac{\partial F(Q_i)_j}{\partial(\Delta Q_j)} \Big|_{Q^{(m-1)}} = 0 \quad (9)$$

For contour (loop) j, where conduits i belong to loop j (10):

$$\Delta_j = - \frac{F(Q_i)_j^{(m-1)}}{\frac{\partial F(Q_i)_j}{\partial(\Delta Q_j)} \Big|_{Q^{(m-1)}}} = - \frac{(\sum R_i \cdot Q_i^n)_j^{(m-1)}}{(n \cdot \sum |R_i \cdot Q_i^{n-1}|)_j^{(m-1)}} \quad (10)$$

For Renouard equation (2): $n=1,82$. Equation (10) in matrix form can be written as (11):

$$\begin{bmatrix} \frac{\partial F_i^{(m-1)}}{\partial(\Delta Q_I)} & 0 & 0 & 0 & 0 \\ 0 & \frac{\partial F_{II}^{(m-1)}}{\partial(\Delta Q_{II})} & 0 & 0 & 0 \\ 0 & 0 & \frac{\partial F_{III}^{(m-1)}}{\partial(\Delta Q_{III})} & 0 & 0 \\ 0 & 0 & 0 & \frac{\partial F_{IV}^{(m-1)}}{\partial(\Delta Q_{IV})} & 0 \\ 0 & 0 & 0 & 0 & \frac{\partial F_V^{(m-1)}}{\partial(\Delta Q_V)} \end{bmatrix} \cdot \begin{bmatrix} \Delta_I^{(m)} \\ \Delta_{II}^{(m)} \\ \Delta_{III}^{(m)} \\ \Delta_{IV}^{(m)} \\ \Delta_V^{(m)} \end{bmatrix} = \begin{bmatrix} F_I^{(m-1)} \\ F_{II}^{(m-1)} \\ F_{III}^{(m-1)} \\ F_{IV}^{(m-1)} \\ F_V^{(m-1)} \end{bmatrix} \quad (11)$$

Detail example for calculation according Hardy Cross's successive substitution method (single loop adjustment method) for network shown in fig. 2 are given in table 4.

4.2 Modified Hardy Cross method (Newton-Raphson simlaneous method)

The Newton-Raphson method is a numerical method that can solve a set of equations (7) simultaneously. Convergence of Newton method nonlinear network analysis is studied by Altman and Boulos [32]. The method is particularly convenient for solving differentiable equations when the value of the desired unknown parameters is known approximately. Using the Taylor's series expansion, a first-order approximation can be written as (12):

$$\begin{bmatrix} \frac{\partial F_I^{(m-1)}}{\partial(\Delta Q_I)} & \frac{\partial F_I^{(m-1)}}{\partial(\Delta Q_{II})} & \frac{\partial F_I^{(m-1)}}{\partial(\Delta Q_{III})} & \frac{\partial F_I^{(m-1)}}{\partial(\Delta Q_{IV})} & \frac{\partial F_I^{(m-1)}}{\partial(\Delta Q_V)} \\ \frac{\partial F_{II}^{(m-1)}}{\partial(\Delta Q_I)} & \frac{\partial F_{II}^{(m-1)}}{\partial(\Delta Q_{II})} & \frac{\partial F_{II}^{(m-1)}}{\partial(\Delta Q_{III})} & \frac{\partial F_{II}^{(m-1)}}{\partial(\Delta Q_{IV})} & \frac{\partial F_{II}^{(m-1)}}{\partial(\Delta Q_V)} \\ \frac{\partial F_{III}^{(m-1)}}{\partial(\Delta Q_I)} & \frac{\partial F_{III}^{(m-1)}}{\partial(\Delta Q_{II})} & \frac{\partial F_{III}^{(m-1)}}{\partial(\Delta Q_{III})} & \frac{\partial F_{III}^{(m-1)}}{\partial(\Delta Q_{IV})} & \frac{\partial F_{III}^{(m-1)}}{\partial(\Delta Q_V)} \\ \frac{\partial F_{IV}^{(m-1)}}{\partial(\Delta Q_I)} & \frac{\partial F_{IV}^{(m-1)}}{\partial(\Delta Q_{II})} & \frac{\partial F_{IV}^{(m-1)}}{\partial(\Delta Q_{III})} & \frac{\partial F_{IV}^{(m-1)}}{\partial(\Delta Q_{IV})} & \frac{\partial F_{IV}^{(m-1)}}{\partial(\Delta Q_V)} \\ \frac{\partial F_V^{(m-1)}}{\partial(\Delta Q_I)} & \frac{\partial F_V^{(m-1)}}{\partial(\Delta Q_{II})} & \frac{\partial F_V^{(m-1)}}{\partial(\Delta Q_{III})} & \frac{\partial F_V^{(m-1)}}{\partial(\Delta Q_{IV})} & \frac{\partial F_V^{(m-1)}}{\partial(\Delta Q_V)} \end{bmatrix} \cdot \begin{bmatrix} \Delta_I^{(m)} \\ \Delta_{II}^{(m)} \\ \Delta_{III}^{(m)} \\ \Delta_{IV}^{(m)} \\ \Delta_V^{(m)} \end{bmatrix} = \begin{bmatrix} F_I^{(m-1)} \\ F_{II}^{(m-1)} \\ F_{III}^{(m-1)} \\ F_{IV}^{(m-1)} \\ F_V^{(m-1)} \end{bmatrix} \quad (12)$$

First matrix in (11) and (12) is a Jacobian matrix of first derivatives of loop equations evaluated at $Q^{(m-1)}$ of all the functions for (12) and for only observed loop in (11). Jacobian matrix is square (number of contours) and symmetric. The rows in Jacobian matrix are corresponding to the loop equations and the columns correlated the loop corrections. The diagonal terms of Jacobian matrix are the sum of first derivatives of the conduit equation in particular contour. The difference between successive substitution method and simultaneous solution method is that some of non-diagonal terms are non-zero in simultaneous solution method.

For the network shown in Fig. 2 Jacobian matrix is for the first iteration (13):

$$[J^{(m-1)}] = \begin{bmatrix} \frac{\partial F_I(Q_1, Q_2, Q_3, Q_4)}{\partial(\Delta Q_I)} & \frac{\partial F_I(-Q_2)}{\partial(\Delta Q_{II})} & 0 & \frac{\partial F_I(-Q_3)}{\partial(\Delta Q_{IV})} & 0 \\ \frac{\partial F_{II}(-Q_2)}{\partial(\Delta Q_I)} & \frac{\partial F_{II}(Q_2, Q_3, Q_6, Q_{11}, Q_{12})}{\partial(\Delta Q_{II})} & \frac{\partial F_{II}(-Q_6)}{\partial(\Delta Q_{III})} & \frac{\partial F_{II}(-Q_{12})}{\partial(\Delta Q_{IV})} & \frac{\partial F_{II}(Q_{11}, Q_{12})}{\partial(\Delta Q_V)} \\ 0 & \frac{\partial F_{III}(-Q_6)}{\partial(\Delta Q_{II})} & \frac{\partial F_{III}(Q_6, Q_7, Q_8, Q_9, Q_{10})}{\partial(\Delta Q_{III})} & 0 & \frac{\partial F_{III}(Q_9, Q_{10})}{\partial(\Delta Q_V)} \\ \frac{\partial F_{IV}(-Q_3)}{\partial(\Delta Q_I)} & \frac{\partial F_{IV}(-Q_{12})}{\partial(\Delta Q_{II})} & 0 & \frac{\partial F_{IV}(Q_3, Q_{12}, Q_{13}, Q_{14})}{\partial(\Delta Q_{IV})} & \frac{\partial F_{IV}(-Q_{12})}{\partial(\Delta Q_V)} \\ 0 & \frac{\partial F_V(Q_{11}, Q_{12})}{\partial(\Delta Q_{II})} & \frac{\partial F_V(Q_9, Q_{10})}{\partial(\Delta Q_{III})} & \frac{\partial F_V(-Q_{12})}{\partial(\Delta Q_{IV})} & \frac{\partial F_V(Q_9, Q_{10}, Q_{11}, Q_{12}, Q_{13})}{\partial(\Delta Q_V)} \end{bmatrix} \quad (13)$$

Numbers in (14) are from first iteration shown in Table 4 (but note that Table 4 is for single loop adjustment method and only input parameters for first iteration have equal numerical values):

$$[W^{(m-1)}] = 1.82 \begin{bmatrix} 1643856824 & -9942302 & 0 & -1570498307 & 0 \\ -9942302 & 883437609 & -5313266 & -326122050 & 559997875 \\ 0 & -5313266 & 408434560 & 0 & 179192287 \\ -1570498307 & -326122050 & 0 & 2046050552 & -179187940 \\ 0 & 559997875 & 179192287 & -179187940 & 3045914618 \end{bmatrix} \quad (14)$$

Note that in eq. (14); $559997875 = 233875825 + 326122050$, and $179192287 = 14916225 + 164276062$ (see Table 4).

5. Rules for determination of algebraic signs preceding corection of flow

These rules are to be applied for both version of method (shown in chapter 4).

Contours and conduits numbers are listed in the first and second columns of the table 4, respectively. Diameters and lengths of conduits are listed in the third and forth column of table 4. The assumed gas flow in each conduit for iteration 1 (shown in Table 2) is listed in the fifth column in table 4. The plus or minus preceding the flow, Q , indicates the direction of the conduit flow for the particular contour. A plus sign denotes clocwises flow in the conduit within the contour; a minus sign, counterclockwise.

The first computation—resistance to change in gas flow in each conduit, $R \cdot Q^{0.82}$ —is listed in table 4 (R is according to (2)). The coefficient n, which in this case equals 1.82 - from Renouard equation (2), has become $n-1=0.82$ (first derivate). The pressure drop in each main, $R \cdot Q^{1.82}$, is listed, and carries the same sign as the gas flow. Column $R \cdot Q^{0.82}$ is added arithmetically for each contour. Column $R \cdot Q^{1.82}$ is added algebraically for each contour. A flow correction, Δ , is computed for each contour - (11) for original method and (12) for improved. This correction must be subtracted algebraically from the assumed gas flow. A conduit common to two loops receives two corrections, and a main common to three or more contours receives three or more corrections.

Correction Δ_1 is from the particular contour under consideration. Corrections Δ_2 and Δ_3 are from the second and third contours to which a conduit belongs. The upper plus or minus sign shown indicates direction of flow in that conduit in these two contours and is obtained from Q for previous iteration. The upper sign is the same as the sign in front of Q if the flow direction in each contour coincides with the assumed flow direction in the particular contour under consideration, and opposite if it does not.

The flow, Q, and corrections are totaled across to obtain the Q listed under next iteration according to the following rules:

1. The algebraic operation for correction 1 should be the opposite of its sign; i.e., add when the sign is minus.
2. The algebraic operation for corrections 2 and 3 should be the opposite of their lower signs when their upper signs are the same as the sign in front of Q, and as indicated by their lower signs when their upper signs are opposite to the sign in front of Q.

Rules for determination of preceding sign for flow corrections is shown in Table 3. Rules shown in table 3 can be presented by following logical equation; Bull's logic (15) and (16):

$$A = \bar{K} \cdot \bar{G} \cdot \bar{D} + \bar{K} \cdot G \cdot D + K \cdot \bar{G} \cdot D + K \cdot G \cdot \bar{D} \quad (15)$$

$$A = C \cdot \bar{D} + \bar{C} \cdot D \quad (16)$$

Where in (16) is auxiliary relation for (17):

$$C = K \cdot G + \bar{K} \cdot \bar{G} \quad (17)$$

Some possible logical circuits according previous equations (15) and (16) are shown in Fig. 3.

Computation according to these rules is by an algebraic subtraction of the flow correction terms.

The iteration procedure is repeated until the net pressure drop around each loop, is as close to zero as the degree of precision desired demands. The network is then in approximate balance.

Pressure drops in conduits along a path from the node of lowest pressure to the supply source are summed to obtain the total pressure drop in the network. When the gas flow in a conduit is in the same direction as the path taken between two nodes, there is a pressure loss. When the flow is opposite to the direction of the path, there is a pressure gain. Since the network is in approximate balance, the total pressure drop should be computed along several paths and averaged to obtain a better value.

6. Results and identification of possible problems

Detail calculation (first two iterations – 1st guess, network in Fig. 2) after original Hardy Cross method (shown in subchapter 4.1) is given in Table 4. Corrections are calculated using eq. (15).

Calculation after improved Hardy Cross method is not given here in such detailed table, but

calculation is done (12) and compared graphically in figs. 4-6 with (11). Set of corrections calculated using eq. (12) for first iteration (1st guess, network in Fig. 2) after modified Cross method (shown in subchapter 4.2) are $\Delta_1=-44/325$, $\Delta_2=-7/93$, $\Delta_3=-48/577$, $\Delta_4=135/862$, and $\Delta_5=103/538$. Modified Hardy Cross method has better convergence performance for all contours (approximately 3-5 increased speed of convergence in our case) for both guess – 1st and 2nd. Same conclusions can be done for convergence of flow corrections (shown in fig. 5 for contour I and in fig. 6 for contour IV).

Example of symmetric network is good example to solve some misunderstandings (initial and final flow pattern are shown in fig. 7, node consumption in Table 1; 3rd guess, initial flow in Table 2, and final results in Table 5). This network is selected very carefully because under above-mentioned circumstances, in conduit 6 two-way flow must be expected (Fig. 8) [33]. But in Hardy Cross calculation that kind of flow in conduit is forbidden and cannot be calculated. Anyway, after the calculation of this network is finished, value of flow in conduit 6 for 3rd guess is 0 m³/s. But real consumers are located between node XI and node VII. That implies that in real network, in conduit 6 some value of flow must be expected (two-way supplied pipes) or some household will be left gasless. In some rare cases, convergence of Hardy Cross method can be spoiled [32]. Recommendations for these cases is to changed method for calculation, i.e. original Hardy Cross instead of improved Hardy Cross, or opposite, or to applied some of other available methods. Even, if the node consumption is satisfied, in some regimes of exploitation of network, some households can be felt lack of gas. These households are place in the middle of conduits, between the nodes. In two-way supplied conduits this case can be occurred (Fig. 9). Also, in our case of symmetric network, convergence is stabile as for 1st and 2nd guess. Under some special

cases, modified Hardy Cross method has not always better convergences characteristics in comparisons to original Hardy Cross method.

7. Conclusions

Approach of Hardy Cross was extremely practical. His view was that engineers lived in a real world with real problems and that it was their job to come up with answers to questions in design even if approximations were involved. Hardy Cross method procedure can give good results when designing a looped gas-pipeline network of composite structure. According to the price and velocity limits, the optimal design can be predicted. This paper addresses to the problem of construction of networks for distribution of natural gas in the cities and with subject to all the practical requirements for the engineers charged with design and/or analysis of such system. This paper is especially addressed to those engineers willing to understand and interpret the results of calculation properly and to make good engineering decision based on this subject. While the spatial natural gas networks with loops are maybe purely hypothetic, this kind of networks, but with some adjustment can find application in calculation of mines ventilation systems.

References:

- [1]. McClure DC, Miller T. Linear-programming offers way to optimize pipeline analysis. Oil Gas J 1983; 81 (29): 135-8.
- [2]. Cross H. Analysis of flow in networks of conduits or conductors. Engineering Experimental Station 1936; 286: 3-29.
- [3]. Epp R, Fowler A.G. Efficient code for steady flows in networks. J Hydraul Div Am Soc Civ Eng 1970; 96 (1): 43-56.

- [4]. Latysenkov AM, Lobacev VG. Hydraulics. 3rd ed. Moscow: Госстройиздат; 1956. (in Russian)
- [5]. Andriyashev MM. Hydraulics calculation of water distribution networks. 1st ed. Moscow: Стройиздат; 1964. (in Russian)
- [6]. Wood DJ, Charles COA. Hydraulic network analysis using linear theory. J Hydraul Div Am Soc Civ Eng 1972; 98 (7): 1157-70.
- [7]. Wood DJ, Rayes AG. Reliability of algorithms for pipe network analysis. J Hydraul Div Am Soc Civ Eng 1981; 107 (10): 1145-61.
- [8]. Shamir U, Howard CDD. Water distribution systems analysis. J Hydraul Div Am Soc Civ Eng 1968; 94: 219- 34.
- [9]. Hamam YM, Brameller A. Hybrid Method for the Solution of Piping Networks. proceedings IEE 1971; 118 (11): 1607-12.
- [10] Todini E, Pilati S. A gradient method for the analysis of pipe networks. In: Coulbeck B, Orr CH, editors. Computer Applications in Water Supply, London: John Wiley & Sons Research Studies Press; 1988, p. 1-20.
- [11]. Patankar SV. Numerical heat transfer and fluid flow. 1st ed. Washington D.C: Hemisphere Publishing Corp; 1980.
- [12]. Datta AB, Majumdar AK. Flow distribution in parallel and reverse flow manifolds. Int J Heat Fluid Fl 1980; 2 (4): 253-62.
- [13]. Corfield G, Hunt BE, Ott RJ, Binder GP, Vandaveer FE. Distribution Design for Increased Demand, Chapter 9. In: Segeler CG, editor. Gas Engineers Handbook, New York: Industrial Press; 1974, p. 63-83.

- [14]. Manojlović V, Arsenović M, Pajović V. Optimized design of a gas-distribution pipeline network. *Appl Energ* 1994; 48 (3): 217-24.
- [15]. Boulos P.F, Lansey K.E, Karney B.W. Comprehensive water distribution systems analysis handbook for engineers and planners. 2nd ed. Hardback: MWH; 2006.
- [16]. Osadacz AJ. Simulation and analysis of gas networks. 1st ed. London: E & F Spon Ltd.; 1991.
- [17]. Arsene CTC, Bargiela A, Al-Dabass D. Modelling and simulation of water systems based on loop equations. *International Journal of Simulation* 2004; 5 (1-2): 61-72.
- [18]. Collins M, Cooper L, Helgason R, Kenningtonf J, Leblanc L. Solving the pipe network analysis problem using optimization techniques. *Manage Sci* 1978; 24 (7): 747-60.
- [19]. Collins A.G, Johnson R.L. Finite-element method for water distribution networks. *J Am Water Works Ass* 1975; 67 (7): 385-9.
- [20]. Gay B, Middleton P. The solution of pipe network problems. *Chem Eng Sci* 1971; 26 (1): 109-23.
- [21]. Chiplunkar AV, Mehndiratta SL, Khanna P. Analysis of looped water distribution networks. *Environmental Software* 1990; 5 (4): 202-6.
- [22]. Gupta I, Bassin JK, Gupta A, Khanna P. Optimization of water distribution system. *Environmental Software* 1993; 8 (2): 101-13.
- [23]. Kessler A, Shamir U. Analysis of the linear programming gradient method for optimal design of water supply networks. *Water Resour Res* 1989; 25 (7): 1469-80.
- [24]. Varma KVK, Narasimhan S, Bhallamudi M. Optimal design of water distribution systems using an NLP method. *Journal of Environmental Engineering* 1997; 123 (4): 381-8.

- [25]. Chenoweth H, Crawford C. Pipe network analysis. *J American Water Works Association* 1974; 66: 55-8
- [26]. Eiger GU, Shamir U, Ben-Tal A. Optimal design of water distribution networks. *Water Resources Research* 1994; 30 (9): 2637-46.
- [27]. Basha HA, Kassab BG. Analysis of water distribution systems using a perturbation method. *Applied Mathematical Modelling* 1996; 20 (4): 290-7.
- [28]. Todini E. Looped water distribution networks design using a resilience index based heuristic approach. *Urban Water* 2000; 2 (2): 115-22.
- [29]. Ahuja RK, Magnanti TL, Orlin JB. Some recent advances in network flows. *SIAM Rev* 1991; 33 (2): 175-219.
- [30]. Zecchin AC, Simpson AR, Maier HR, Leonard M, Roberts AJ, Berrisford MJ. Application of two ant colony optimisation algorithms to water distribution system optimisation. *Math Comput Model* 2006; 44 (4-5): 451–68.
- [31]. Coelho PM, Pinho C. Considerations about equations for steady state flow in natural gas pipelines. *Journal of the Brazilian Society of Mechanical Sciences and Engineering* 2007; 29 (3): 262-73.
- [32]. Altman T, Boulos PF. Convergence of Newton method nonlinear network analysis. *Math Comput Model* 1995; 21 (4): 35-41.
- [33]. Kaluđerčić P. Problem of two-way supplied pipes in a gas network. *Gas* 2002, 7 (2-3): 48-51. (in Serbian)

Vitae

Dejan Brkić (1975-) is a PhD candidate at University of Belgrade, Faculty of Mining and Geology, Serbia. His research is supported by Ministry of Science of Republic of Serbia, during a scholarship program. He received his MSc degree in petroleum engineering in 2002 and MSc degree with thesis in treatment and transport of fluids in 2005, both from the Faculty of Mining and Geology. He also has postgraduate education in field of environmental protection. He has written over 25 papers that have been published in international and national journals as well as conference proceedings, including one book “Prirodni gas kao gorivo za grejanje (Natural Gas as Heating Fuel)” in Serbian. His research interest includes design of natural gas distribution networks and implementation of natural gas heating systems in urban areas.

Figure captions

Figure 1. Transformations of pseudo-spatial network A) and spatial network C)

Figure 2. Spatial gas distribution network with contours – example

Figure 3. Logical circuits for determination of signs for corrections

Figure 4. Pressure drop in iterative procedure per contour I for 1st and 2nd guess (network from fig. 2)

Figure 5. Flow correction in iterative procedure per contour I for 1st guess (network from fig. 2)

Figure 6. Flow correction in iterative procedure per contour I for 2nd guess (network from fig. 2)

Figure 7. Flow pattern in symmetric network (3rd guess)

Figure 8. Two type of changes of flow Q and pressure p in conduit

Figure 9. Special case of two-way supplied conduits

Table captions

Table 1 Constant node outflow

Table 2 First assumed flows

Table 3 Combinations for choose of final algebraic sign of second rang correction or higher

Table 4 Calculation of spatial natural gas distributive network of conduits with loops after original Hardy Cross method (example from fig. 2)- 1st initial guess

Table 5 Final (calculated) flows in the network for both methods

Figure 1 DB ver 3

[Click here to download high resolution image](#)

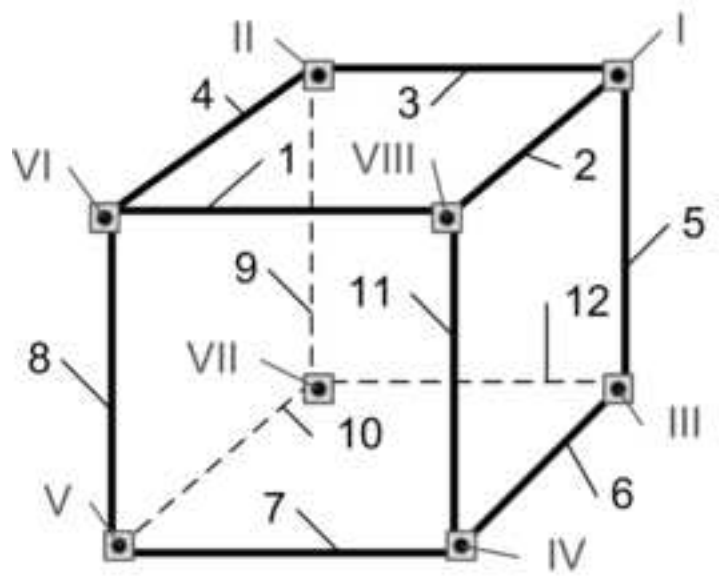

A

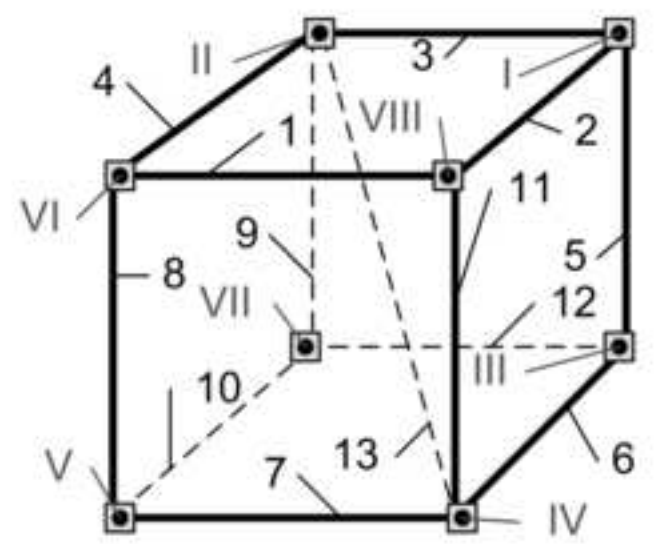

B

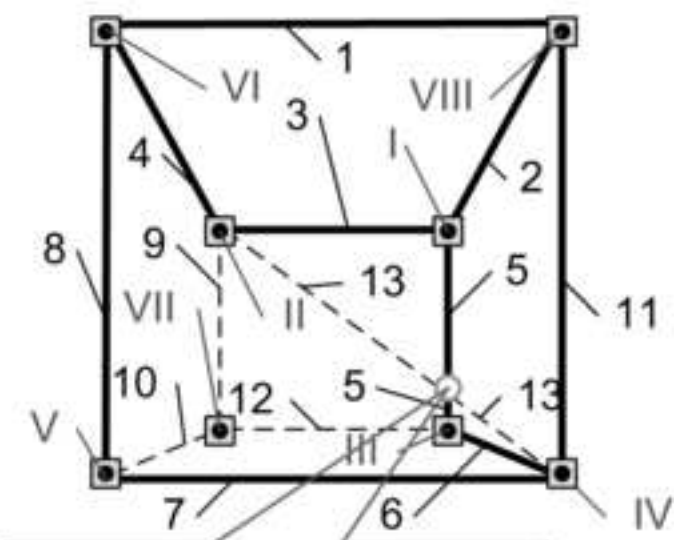
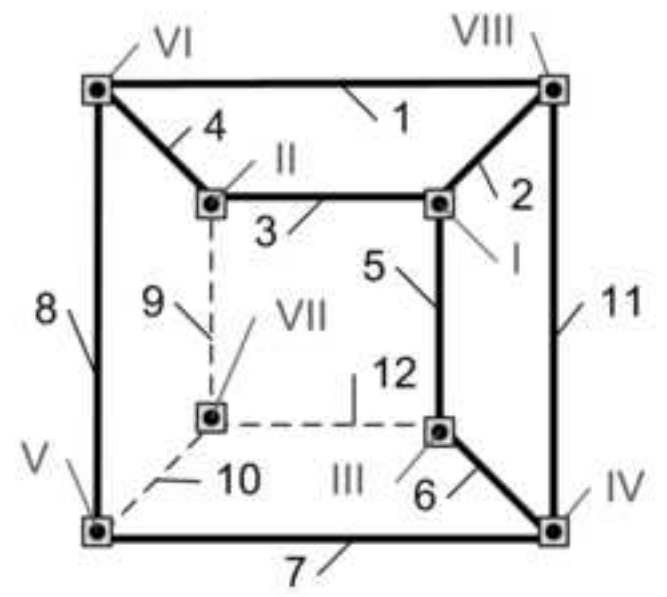

This is not Node (conduits 13 and 5 are not connected)

Figure 2 DB colour ver 3
[Click here to download high resolution image](#)

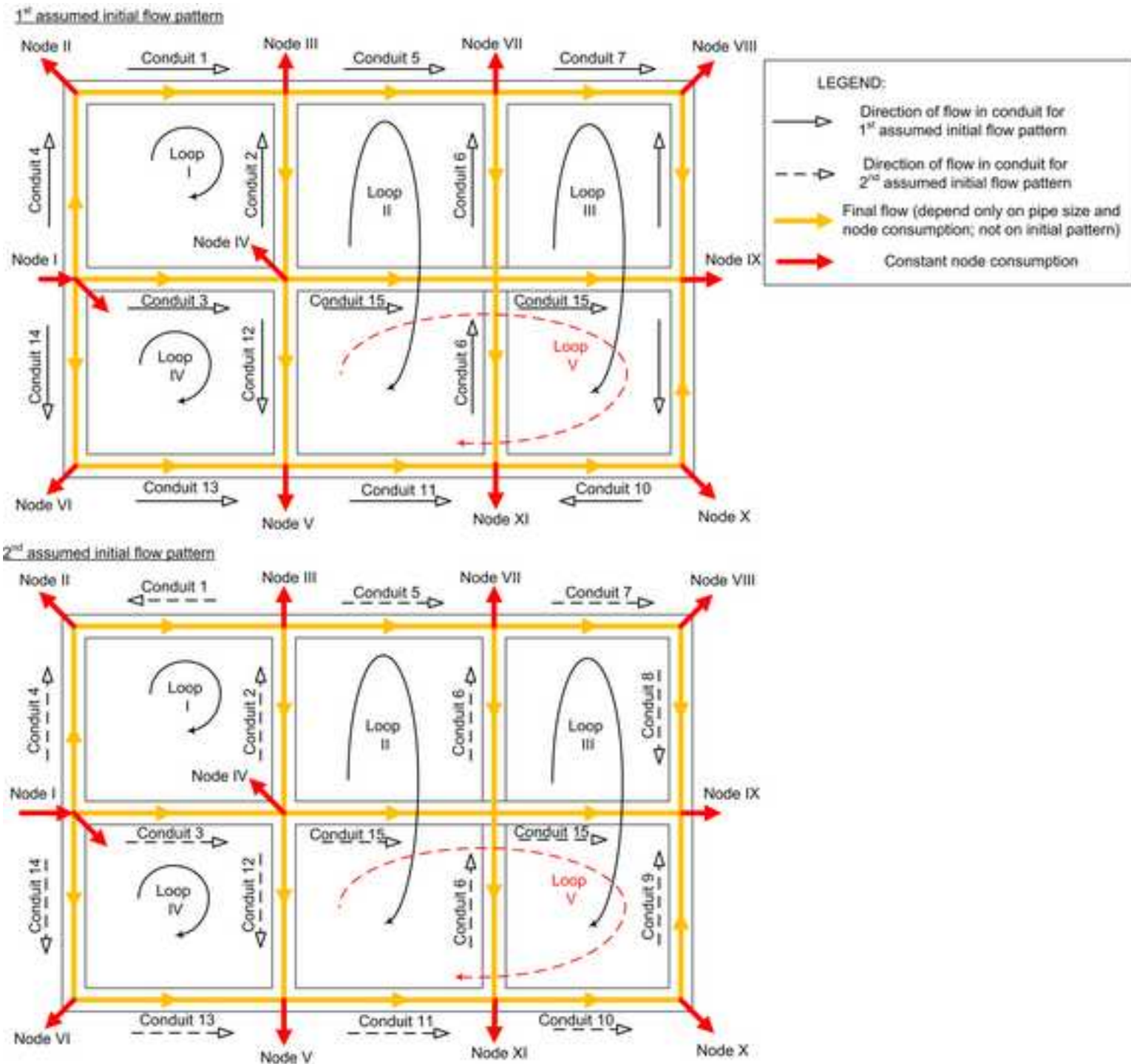

Figure 2 DB hardcopy ver 3
[Click here to download high resolution image](#)

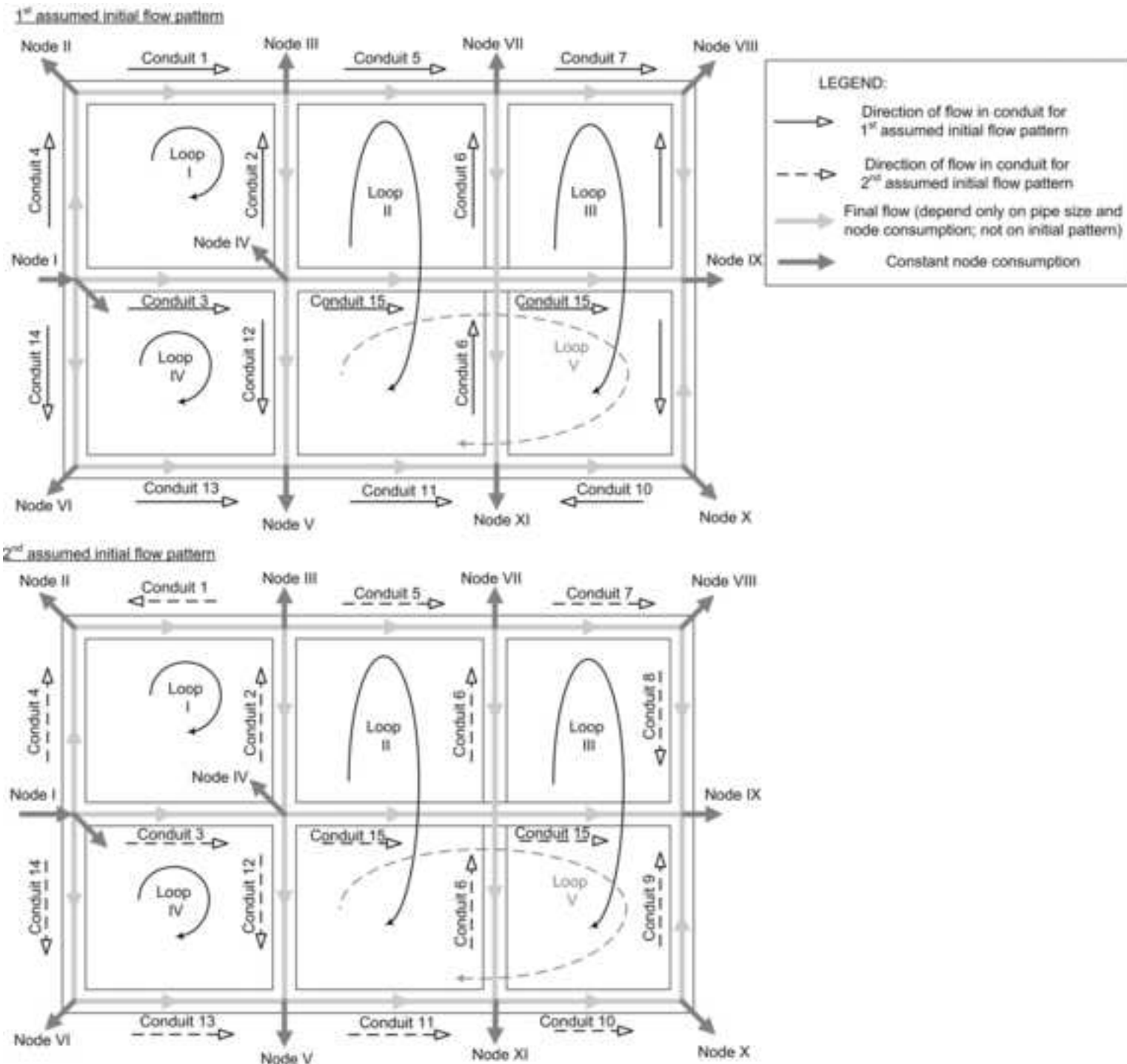

Figure 3 DB ver 3

[Click here to download high resolution image](#)

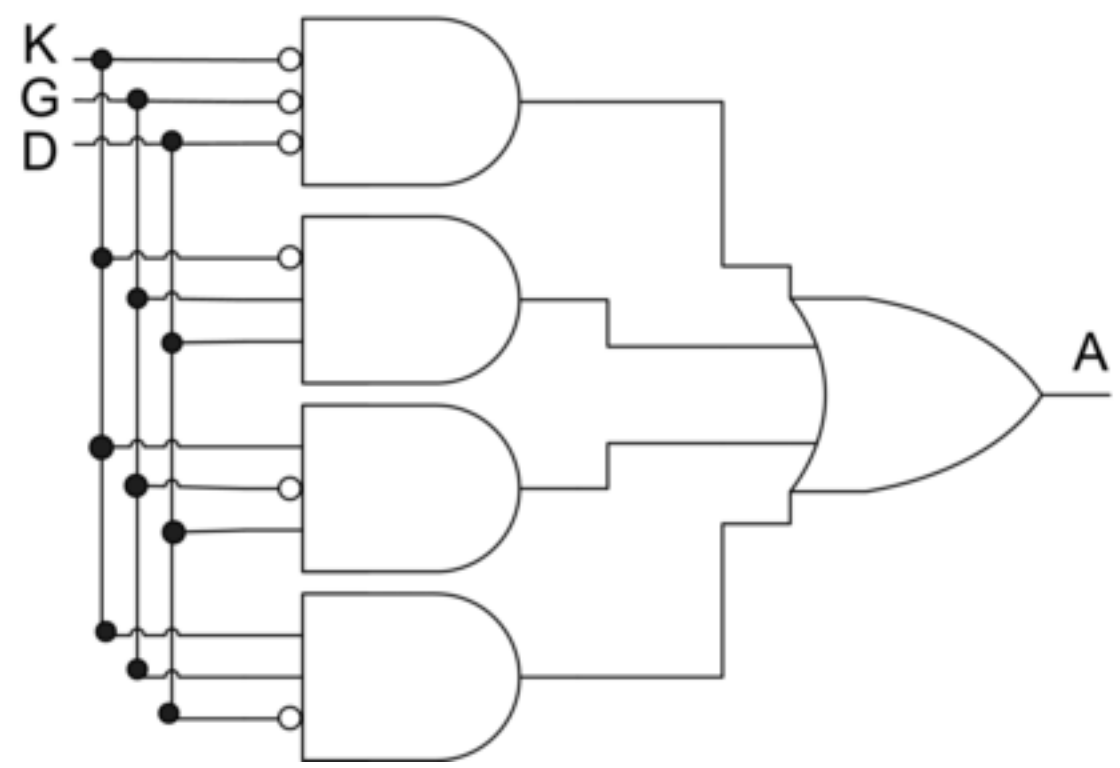
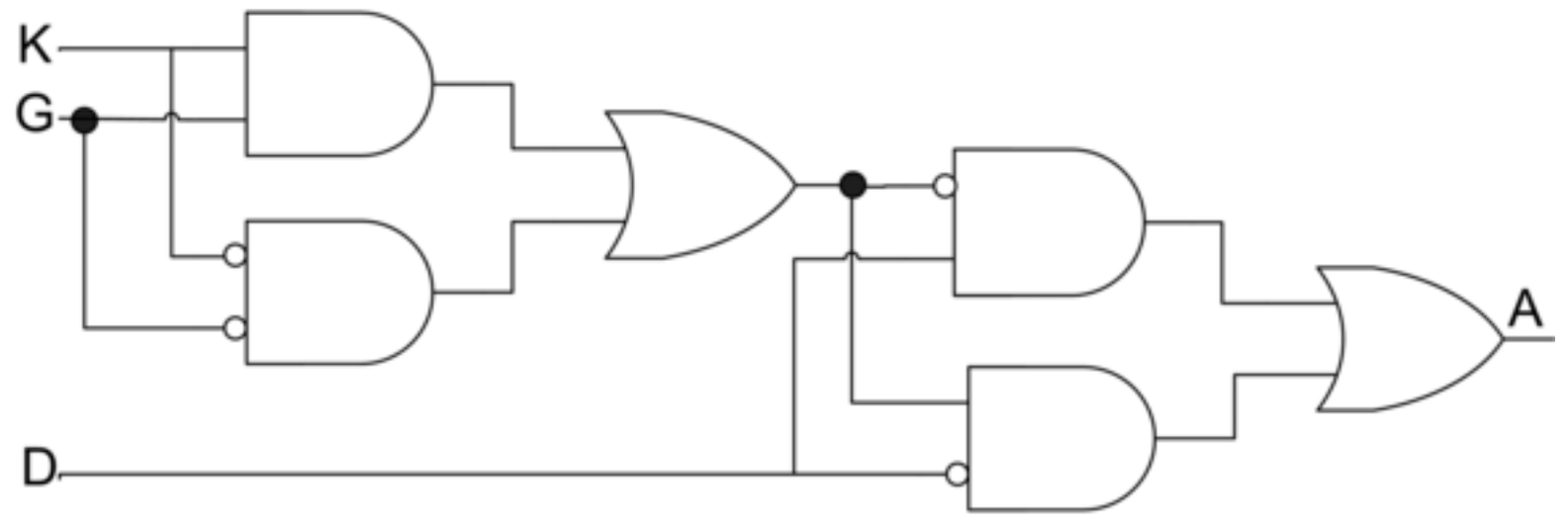

Figure 4 DB ver 3

[Click here to download high resolution image](#)

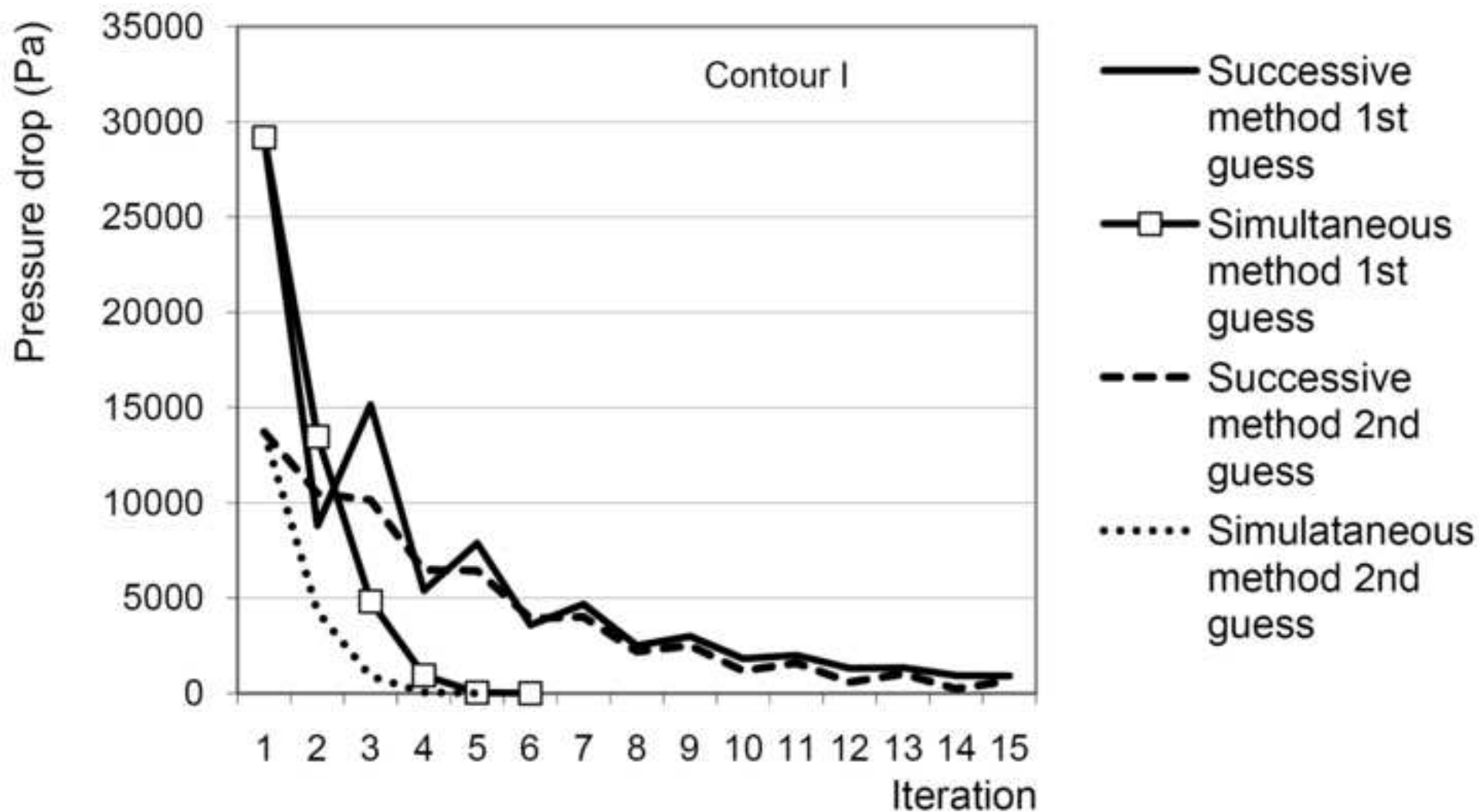

Figure 5 DB ver 3
[Click here to download high resolution image](#)

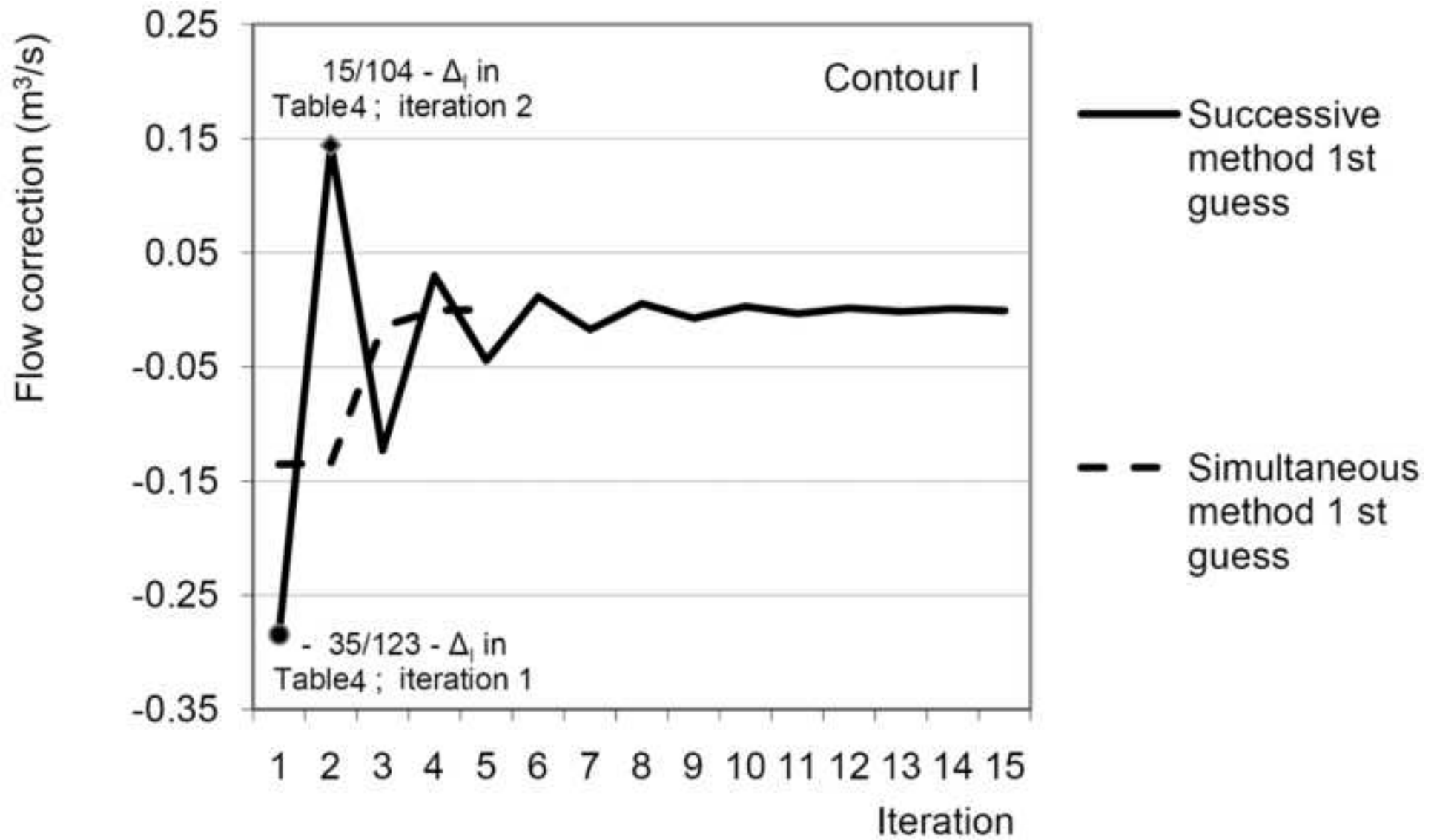

Figure 6 DB ver 3

[Click here to download high resolution image](#)

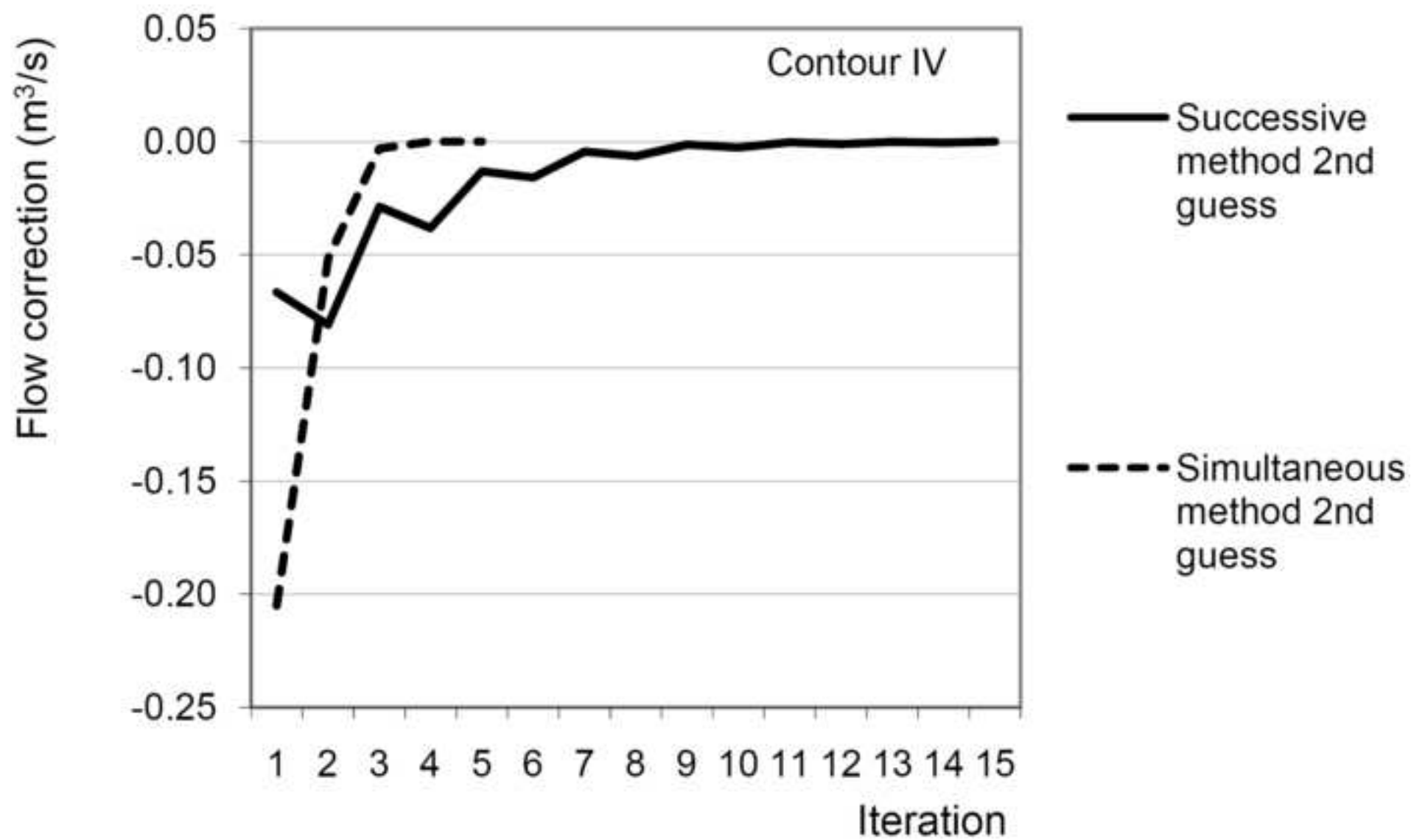

Figure 7 DB colour ver 3
[Click here to download high resolution image](#)

3rd assumed initial flow pattern-different node consumptions and pipe diameters compared to fig 2

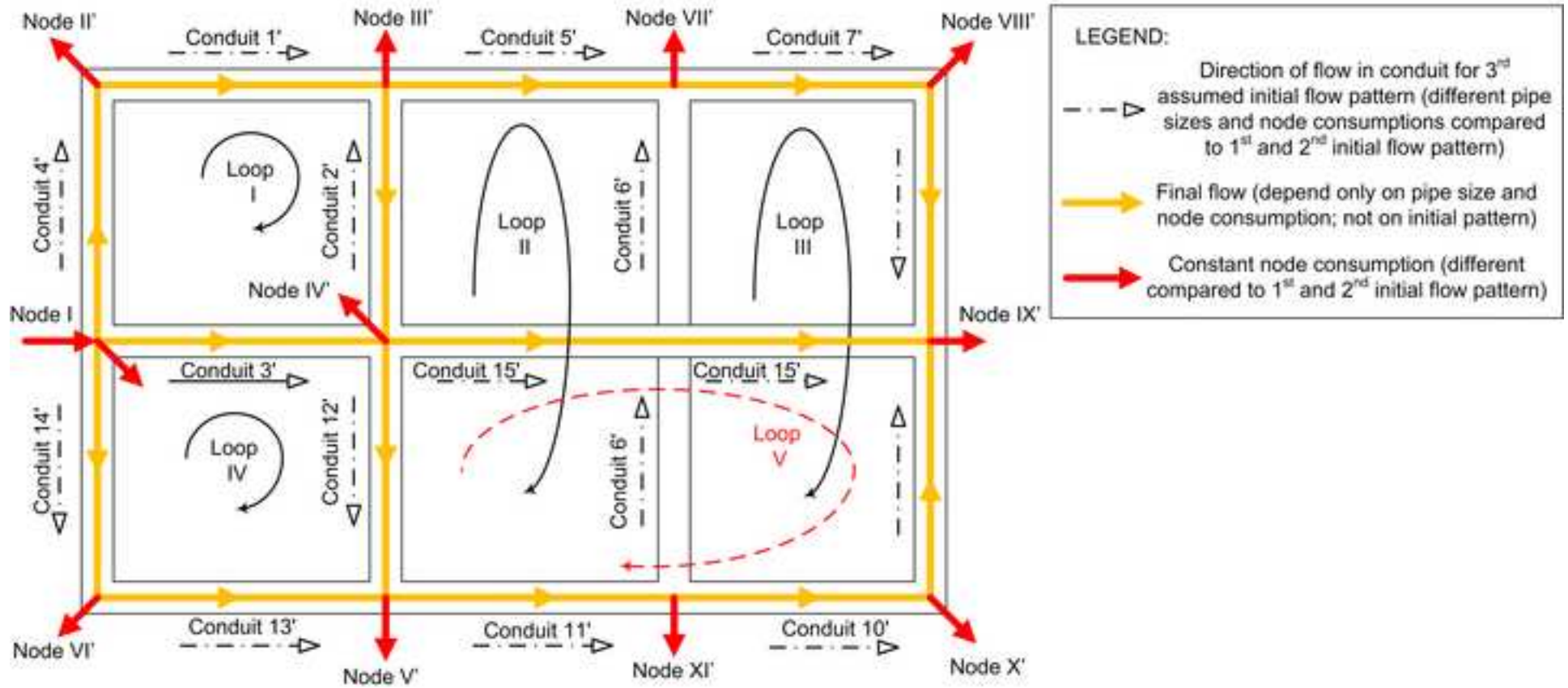

Figure 7 DB hardcopy ver 3
[Click here to download high resolution image](#)

3rd assumed initial flow pattern-different node consumptions and pipe diameters compared to fig 2

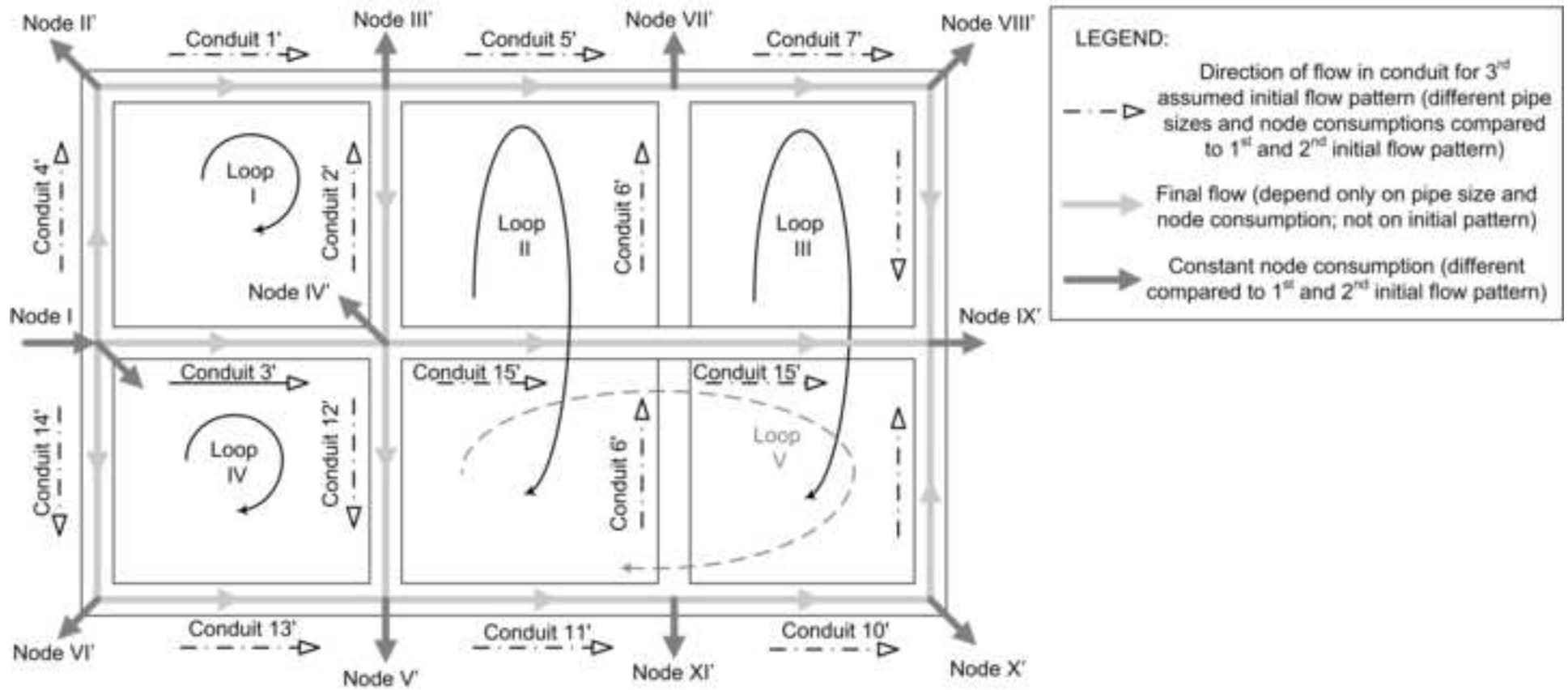
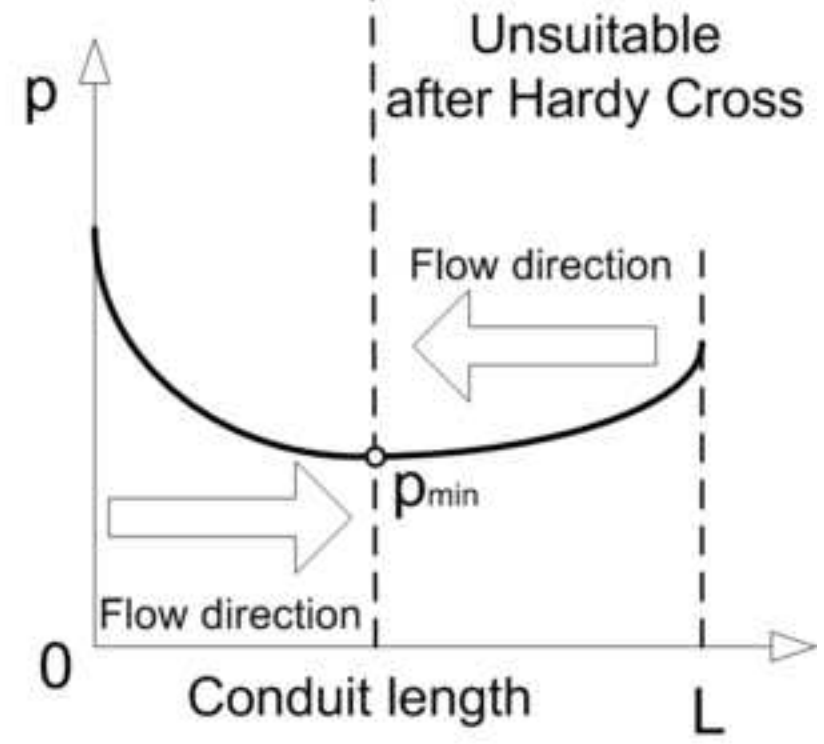
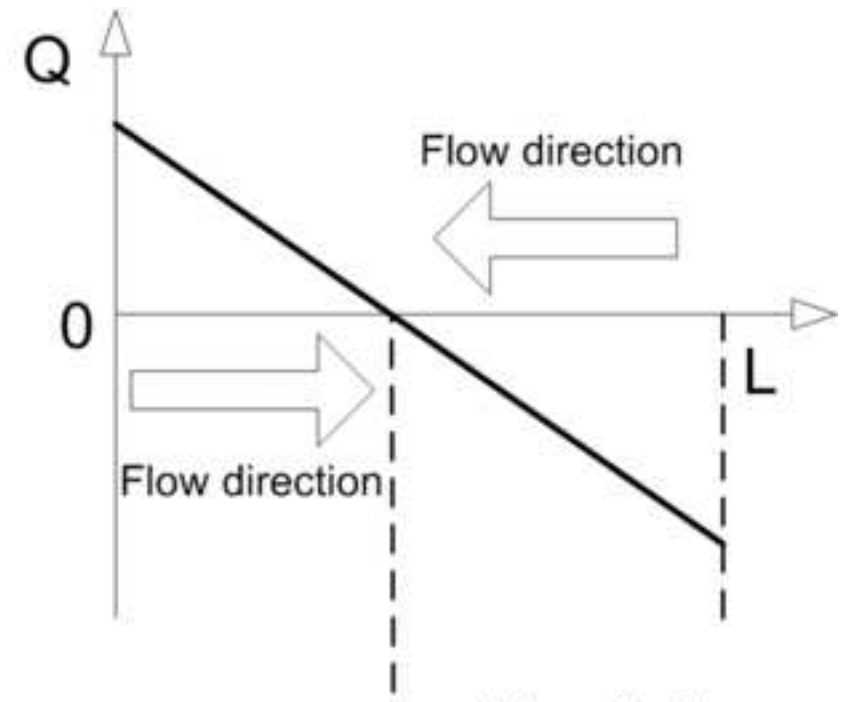
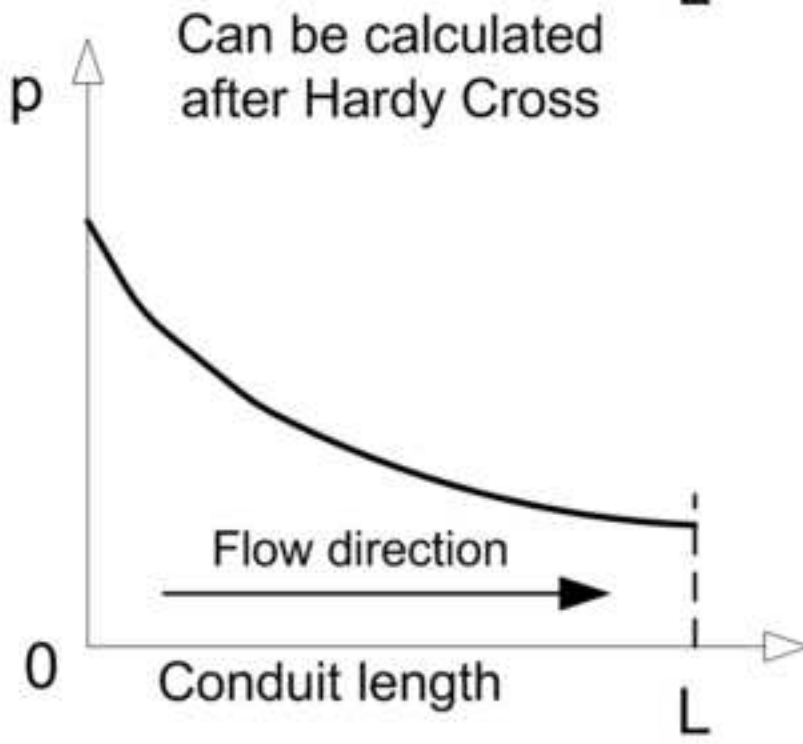
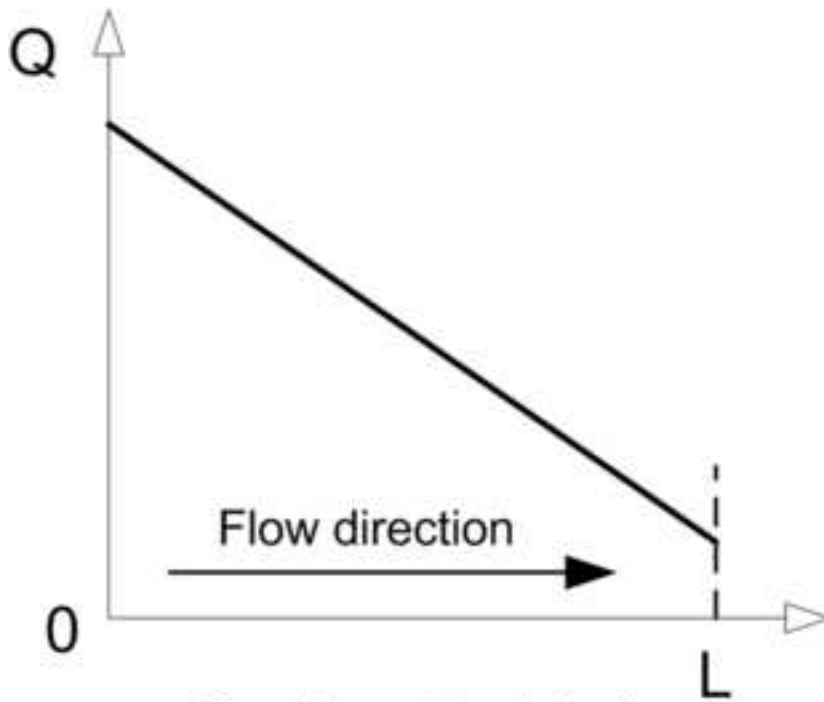
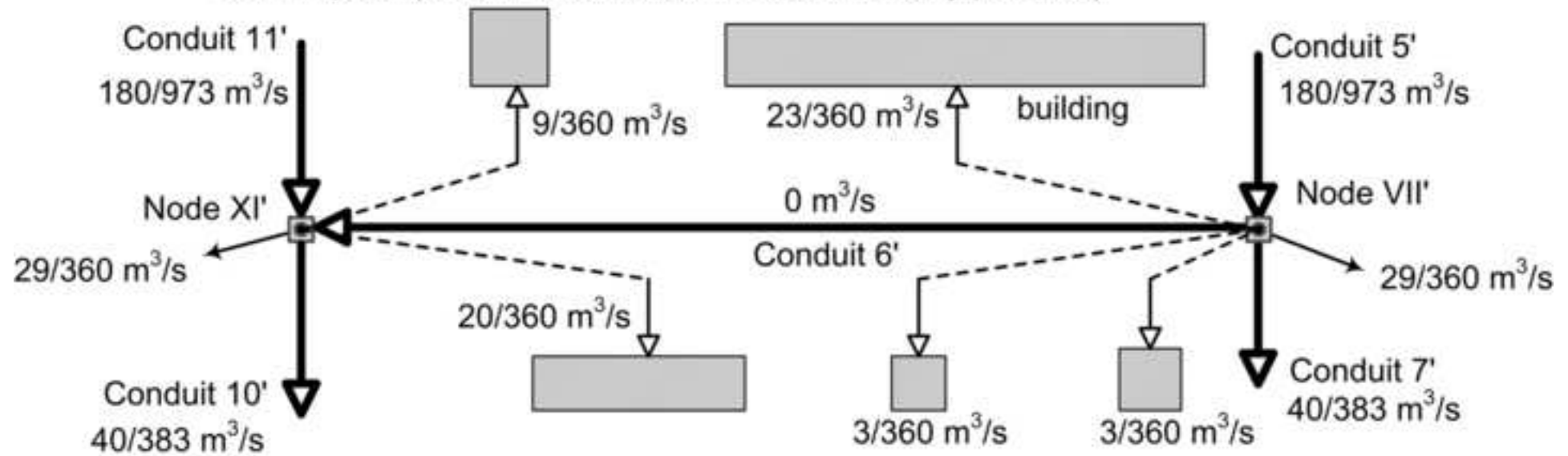

Figure 8 DB ver 3
[Click here to download high resolution image](#)



After Hardy Cross – values of flow calculated for maximal consumption (one direction of flow in conduit is only possible)



Real conditions – consumption is maximal or under maximum values (double direction of flow in conduit – some of the consumers in the middle of conduit may have lack of gas)

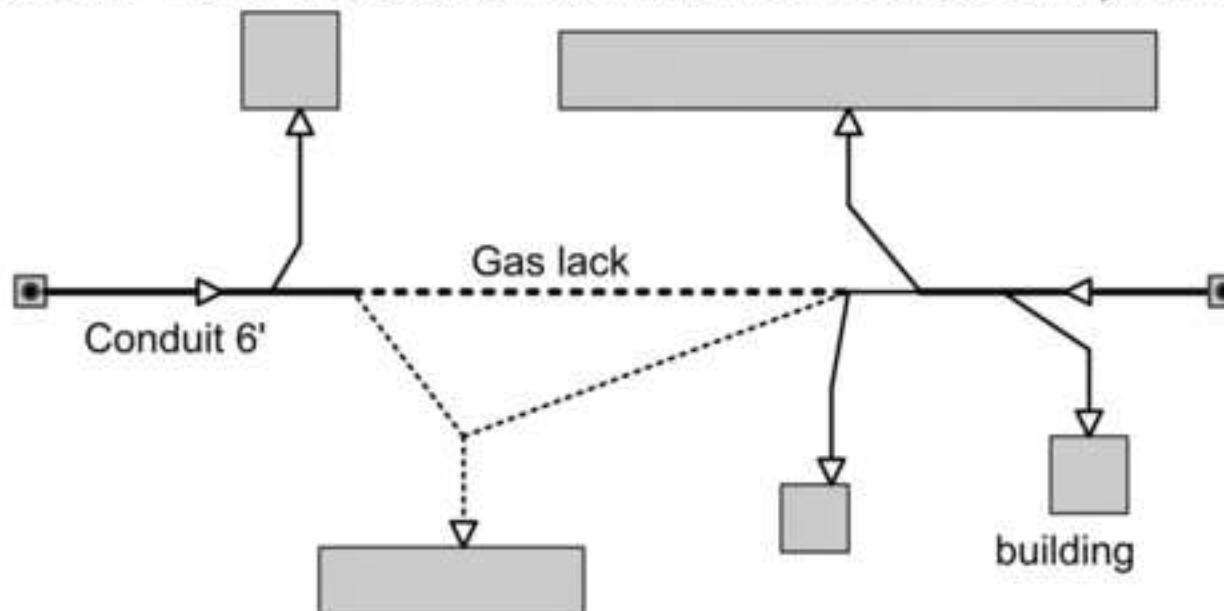

Table 1
Constant node outflows

Consumption					
^a Asymmetric 1 st and 2 nd guess			^b Symmetric – 3 rd guess		
Node	m ³ /h	m ³ /s	Node	m ³ /h	m ³ /s
I	60	1/60	I'	60	1/60
II	2100	7/12	II'	2300	23/36
III	170	17/360	III'	185	37/720
IV	90	1/40	IV'	90	1/40
V	200	1/18	V'	185	37/720
VI	2500	25/36	VI'	2300	23/36
VII	300	1/12	VII'	290	29/360
VIII	170	17/360	VIII'	225	1/16
IX	850	17/72	IX'	850	17/72
X	280	7/90	X'	225	1/16
XI	280	7/90	XI'	290	29/360
^c Flow into the network					
Node	m ³ /h	m ³ /s	Node	m ³ /h	m ³ /s
I	-7000	-1 17/18	I'	-7000	-1 17/18

^a constant in calculation (network - Fig. 2)

^b constant in calculation (network - Fig. 7)

^c Flow into the network is sum of consumptions per nodes

Table 2

First assumed flows

^a First assumed flows per conduit - m ³ /s				
^b initial guess of gas flow rate				
conduit	^c I	^d II	conduit	^e III
1	1/18	1/36	1'	7/36
2	5/72	1/12	2'	1/9
3	17/30	47/180	3'	47/180
4	23/36	5/9	4'	5/6
5	7/90	1/120	5'	61/240
6	1/72	31/180	6'	13/144
7	1/120	7/72	7'	19/72
8	7/180	1/20	8'	29/144
9	41/360	7/60	9'	1/48
10	13/360	7/36	10'	1/12
11	1/18	4/9	11'	61/240
12	1/12	1/12	12'	1/9
13	1/36	5/12	13'	7/36
14	13/18	1 1/9	14'	5/6
15	7/18	5/72	15'	1/72

^a must be chosen to satisfy rule after first Kirchhoff's law for all nodes (exactly)

^b initial guess means: distribution of flows for first iteration

^c chosen after eq. (1) – (1st guess, network Fig. 2)

^d chosen to satisfy only mandatory first Kirchhoff's law for all nodes, but not chosen after eq. (1) – (2nd guess, network Fig. 2)

^e flow pattern chosen for symmetric node consumption (see Table 1) - (3rd guess, network Fig. 7)

Table 3

Combinations for choose of final algebraic sign of second rang correction or higher

Sign preceding flow ^a K	Signs preceding second or higher correction ^b		Chosen final algebraic sign A
	Upper sign ^c G	Lower sign ^d D	
0 (-) ^e	0 (-)	0 (-)	1 (+) ^f
0 (-)	0 (-)	1 (+)	0 (-)
0 (-)	1 (+)	0 (-)	0 (-)
0 (-)	1 (+)	1 (+)	1 (+)
1 (+)	0 (-)	0 (-)	0 (-)
1 (+)	0 (-)	1 (+)	1 (+)
1 (+)	1 (+)	0 (-)	1 (+)
1 (+)	1 (+)	1 (+)	0 (-)

^aindicates the direction of the conduit flow for particular loop (contour) – a plus sign denotes clockwise flow in the conduit within the loop; a minus sign, counterclockwise

^bsecond rang correction is from the second contour to which a conduit belongs, third rang correction is from the third contour to which a conduit belongs, etc.

^cthe upper plus or minus sign shown indicates direction of flow in that conduit in these two contours and is obtained from Q for previous iteration. The upper sign is the same as the sign in front Q if the flow direction in the particular contour under consideration, and opposite if it does not.

^dthe lower sign is copied from the primary contour for this correction (sign from the contour where this correction is first, sign preceding the first iteration from adjacent contour for the conduit taken into consideration)

^elogical zero is equivalent to sign (-) minus

^flogical one is equivalent to sign (+) plus

Table 4

Calculation of spatial natural gas distributive network of conduits with loops after original Hardy Cross method (example from fig. 2)- 1st initial guess

*	**	D _{in}	L	Iteration 1						Iteration 2 ^a				
				°Q	(1)		Flow correction Δ ^b			Q	Flow correction Δ ^b			Q
					R·Q ^{1,82}	R·Q ^{0,82}	1	2	3		1	2	3	
I	1	0.4064	100	+1/18	114959	2069265	+35/123	+251/738	-15/104	+19/97
	2	0.3048	100	-5/72	-690438	9942302	+35/123	-6/619±	...	+91/443 ^d	-15/104	-4/73=	...	+5/782
	3	0.1524	100	-17/30	-889949040	1570498307	+35/123	+53/219±	...	-31/773	-15/104	-89/743±	...	-59/194
	4	0.3048	100	+23/36	39193885	61346951	+35/123	+193/209	-15/104	+60/77
	Σ				-851330634	1643856824	$\Delta_1 = \frac{-851330634}{1,82 \cdot 1643856824} = -\frac{35}{123}$			***8805	$\Delta_1 = \frac{77528086}{1,82 \cdot 295343529} = \frac{15}{104}$			
II	5	0.1524	100	+7/90	23969880	308184165	+6/619	+37/423	+4/73	+34/239
	6	0.3048	200	-1/72	-73795	5313266	+6/619	+1/560±	...	-1/415	+4/73	-27/539±	...	+1/437 ^d
	11	0.1524	100	-1/18	-12993101	233875825	+6/619	-43/303 ∓	...	-89/441	+4/73	-13/392 ∓	...	-20/111
	12	0.1524	100	-1/12	-27176838	326122050	+6/619	+53/219±	-114/731 ∓	+2/161 ^d	+4/73	-89/743=	-13/392±	-3/35 ^d
	2	0.3048	100	+5/72	690438	9942302	+6/619	-35/123=	...	-91/443 ^d	+4/73	+15/104±	...	-5/782
Σ				-15583417	883437609	$\Delta_{II} = \frac{-15583417}{1,82 \cdot 883437609} = -\frac{6}{619}$			***10506	$\Delta_{II} = \frac{-110372041}{1,82 \cdot 1106807745} = -\frac{4}{73}$				
III	7	0.1524	100	+1/120	411338	49360570	-1/560	+4/611	+27/539	+29/512
	8	0.1524	100	-7/180	-6788773	174568437	-1/560	-29/713	+27/539	+5/531 ^d
	9	0.3048	100	+41/360	1698792	14916225	-1/560	-114/731±	...	-31/707 ^d	+27/539	-13/392 ∓	...	-7/260
	10	0.1524	100	+13/360	5932191	164276062	-1/560	-114/731±	...	-9/74 ^d	+27/539	-13/392 ∓	...	-78/745
	6	0.3048	200	+1/72	73795	5313266	-1/560	-6/619=	...	+1/415	+27/539	-4/73=	...	-1/437 ^d
Σ				1327344	408434560	$\Delta_{III} = \frac{1327344}{1,82 \cdot 408434560} = \frac{1}{560}$			***7841	$\Delta_{III} = \frac{-61479037}{1,82 \cdot 674361136} = -\frac{27}{539}$				
IV	3	0.1524	100	+17/30	889949040	1570498307	-53/219	-35/123=	...	+31/773	+89/743	+15/104 ∓	...	+59/194
	12	0.1524	100	+1/12	27176838	326122050	-53/219	-6/619=	+114/731 ∓	-2/161 ^d	+89/743	-4/73±	+13/392±	+3/35 ^d
	13	0.1524	100	-1/36	-3679919	132477076	-53/219	-242/897	+89/743	-3/20
	14	0.4064	100	-13/18	-12243919	16953118	-53/219	-647/671	+89/743	-38/45
Σ				901202040	2046050552	$\Delta_{IV} = \frac{901202040}{1,82 \cdot 2046050552} = \frac{53}{219}$			***15651	$\Delta_{IV} = \frac{-244942051}{1,82 \cdot 1123546748} = -\frac{89}{743}$				
V	15	0.1524	200	+7/18	897059511	2306724456	-114/731	+157/674	-13/392	+177/886
	9	0.3048	100	+41/360	1698792	14916225	-114/731	-1/560±	...	-31/707 ^d	-13/392	+27/539=	...	-7/260
	10	0.1524	100	+13/360	5932191	164276062	-114/731	-1/560±	...	-9/74 ^d	-13/392	+27/539=	...	-78/745
	11	0.1524	100	-1/18	-12993101	233875825	-114/731	+6/619=	...	-89/441	-13/392	+4/73 =	...	-20/111
	12	0.1524	100	-1/12	-27176838	326122050	-114/731	+6/619=	+53/219±	+2/161 ^d	-13/392	+4/73 ±	-89/743=	-3/35 ^d
Σ				864520555	3045914618	$\Delta_V = \frac{864520555}{1,82 \cdot 3045914618} = \frac{114}{731}$			***12786	$\Delta_V = \frac{163492506}{1,82 \cdot 2708713524} = \frac{13}{392}$				

*-mark Loop i.e. Contour, **-mark Conduit i.e. Pipe (Main), ***-pressure drop per Loop i.e. Contour (Pa)

^acalculation of R·Q_{con}^{1,82} and R·Q_{con}^{0,82} are not shown explicitly as in iteration 1

^bΔ₁ must be added with opposite preceding sign, Δ₂ and Δ₃ must be added with adopted preceding sign (according to rule shown in table 3)

^cfirst assumed (initial) guess (flows per all conduits must be chosen to satisfy first Kirchhoff's law for all nodes – sum of pressure drops *** per all loops according to second Kirchhoff's law must be (approximate) zero when the network is in balance (here after 15 iterations) – see Fig 4

^dchange of flow direction (opposite than in previous iteration – opposite upper sign in Δ₂ and Δ₃)

Table 5

Final (calculated) flows in the network for both methods

1 st and 2 nd guess					3 rd guess ^d				
conduit	^a Final flow			^b Velocity check	^c conduit	^a Final flow			^b Velocity check
	D _{in} (m)	m ³ /s	m ³ /h	m/s		D _{in} (m)	m ³ /s	m ³ /h	m/s
1	0.4064	334/979	1228.19	2.63	1 ^o	0.1524	85/421	726.84	11.07
2	0.3048	13/129	362.80	1.38	2 ^o	0.1524	1/29	124.14	1.89
3	0.1524	82/539	547.68	8.34	3 ^o	0.1524	81/329	886.32	13.50 ^d
4	0.3048	551/596	3328.19	12.67	4 ^o	0.3048	639/760	3026.84	11.52
5	0.1524	130/673	695.39	10.59	5 ^o	0.1524	180/973	665.98	10.14
6	0.3048	1/71	50.73	0.19	6 ^o	0.3048	0	0	0
7	0.1524	9/94	344.66	5.25	7 ^o	0.1524	40/383	375.98	5.73
8	0.1524	18/371	174.66	2.66	8 ^o	0.3048	32/763	150.98	0.57
9	0.3048	22/687	115.28	0.44	9 ^o	0.3048	32/763	150.98	0.57
10	0.1524	28/255	395.28	6.02	10 ^o	0.1524	40/383	375.98	5.73
11	0.1524	106/611	624.55	9.51	11 ^o	0.1524	180/973	665.98	10.14
12	0.1524	17/235	260.43	3.97	12 ^o	0.1524	1/29	124.14	1.89
13	0.1524	76/485	564.13	8.59	13 ^o	0.1524	85/421	726.84	11.07
14	0.4064	223/262	3064.13	6.56	14 ^o	0.3048	639/760	3026.84	11.52
15	0.1524	7/45	560.05	8.53	15 ^o	0.1524	58/381	548.03	8.35

^a calculation is over when second Kirchhoff's law is approximately satisfied (after n iterations) for all contours (loops) – algebraic sum of pressure drop per conduit is approximately equal zero. Note that final flow is not depend on first assumed gas flow and chosen type of methods,

^b must be under standard values [14] - The velocity limits are 6 m/s for the pipes of small diameter (up to 0,09 m) and 12 m/s for the pipes of large diameter (up to 0,225 m) (if not must be changed diameter of conduit and must be repeated whole calculation)

^c symmetric network, Fig. 7

^d velocity limit is exceeded in conduit 3 (must be increased diameter of conduit and must be repeated whole calculation)